

GP2A200LCS0F Series

Detecting Distance : 2 to 22mm
 *OPIC Output,
 Reflective Photointerrupter with
 Connector

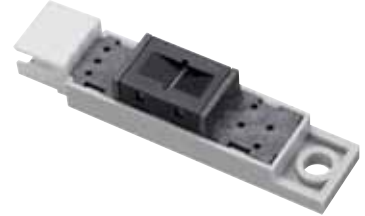

■ Description

GP2A200LCS0F Series are OPIC output, reflective photointerrupters with emitter and detector facing the same direction in a molding that provides non-contact sensing. This family of devices uses light modulation to reduce the affects of disturbing light, and the sensor is optimized to work in the selected focal distance. A 3-pin connector is included to allow remote-mount or off-board designs.

■ Features

1. Reflective with OPIC Light Modulated Output
2. Highlights :
 - Includes additional screw fixing holes
 - Position pin to prevent mis-alignment
 - Long focal distance
3. Key Parameters :
 - Detecting distance : 2 to 22mm (White paper)
5 to 15mm (Black paper)
 - Undetecting distance : over 90mm (White paper)
 - Connector : **GP2A200LCS0F** ; Tyco Electronics AMP K.K.
(PN : 292133-3)
GP2A200LCSCF ; Tyco Electronics AMP K.K.
(PN : 292133-3)
GP2A240LCS0F ; Tyco Electronics AMP K.K.
(PN : 292133-3)
GP2A210LCSJF ; Tyco Electronics AMP K.K.
(PN : 4-292133-3)
4. RoHS directive compliant

■ Agency approvals/Compliance

1. Compliant with RoHS directive

■ Applications

1. General purpose detection of paper presence or motion.
2. Example: PPC, FAX, Printer

* "OPIC"(Optical IC) is a trademark of the SHARP Corporation. An OPIC consists of a light-detecting element and a signal-processing

Notice The content of data sheet is subject to change without prior notice.
 In the absence of confirmation by device specification sheets, SHARP takes no responsibility for any defects that may occur in equipment using any SHARP devices shown in catalogs, data books, etc. Contact SHARP in order to obtain the latest device specification sheets before using any SHARP device.

Internal Connection Diagram

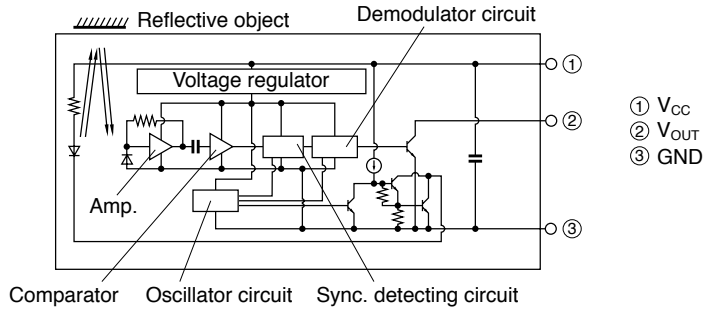

Outline Dimensions

(Unit : mm)

<h4>GP2A200LCS0F</h4> <p>• Unspecified tolerance shall be as follows ;</p> <table border="1"> <thead> <tr> <th>Dimensions</th> <th>Tolerance</th> </tr> </thead> <tbody> <tr> <td>less than 6</td> <td>±0.2</td> </tr> <tr> <td>6 or more less than 14</td> <td>±0.3</td> </tr> <tr> <td>14 or more</td> <td>±0.4</td> </tr> </tbody> </table> <p>• (*) : Reference dimensions</p> <p>Product mass : approx. 1.95g</p>	Dimensions	Tolerance	less than 6	±0.2	6 or more less than 14	±0.3	14 or more	±0.4	<h4>GP2A200LCS0F</h4> <p>• Unspecified tolerance shall be as follows ;</p> <table border="1"> <thead> <tr> <th>Dimensions</th> <th>Tolerance</th> </tr> </thead> <tbody> <tr> <td>less than 6</td> <td>±0.2</td> </tr> <tr> <td>6 or more less than 14</td> <td>±0.3</td> </tr> <tr> <td>14 or more</td> <td>±0.4</td> </tr> </tbody> </table> <p>• (*) : Reference dimensions</p> <p>Product mass : approx. 2.3g</p>	Dimensions	Tolerance	less than 6	±0.2	6 or more less than 14	±0.3	14 or more	±0.4
Dimensions	Tolerance																
less than 6	±0.2																
6 or more less than 14	±0.3																
14 or more	±0.4																
Dimensions	Tolerance																
less than 6	±0.2																
6 or more less than 14	±0.3																
14 or more	±0.4																
<h4>GP2A210LCSJF</h4> <p>• : Portion Built-in IR-90 filter</p> <p>• Unspecified tolerance shall be as follows ;</p> <table border="1"> <thead> <tr> <th>Dimensions</th> <th>Tolerance</th> </tr> </thead> <tbody> <tr> <td>less than 6</td> <td>±0.2</td> </tr> <tr> <td>6 or more less than 14</td> <td>±0.3</td> </tr> <tr> <td>14 or more</td> <td>±0.4</td> </tr> </tbody> </table> <p>• (*) : Reference dimensions</p> <p>Product mass : approx. 1.95g</p>	Dimensions	Tolerance	less than 6	±0.2	6 or more less than 14	±0.3	14 or more	±0.4	<h4>GP2A240LCS0F</h4> <p>• Unspecified tolerance shall be as follows ;</p> <table border="1"> <thead> <tr> <th>Dimensions</th> <th>Tolerance</th> </tr> </thead> <tbody> <tr> <td>less than 6</td> <td>±0.2</td> </tr> <tr> <td>6 or more less than 14</td> <td>±0.3</td> </tr> <tr> <td>14 or more</td> <td>±0.4</td> </tr> </tbody> </table> <p>• (*) : Reference dimensions</p> <p>Product mass : approx. 1.95g</p>	Dimensions	Tolerance	less than 6	±0.2	6 or more less than 14	±0.3	14 or more	±0.4
Dimensions	Tolerance																
less than 6	±0.2																
6 or more less than 14	±0.3																
14 or more	±0.4																
Dimensions	Tolerance																
less than 6	±0.2																
6 or more less than 14	±0.3																
14 or more	±0.4																

Connector terminal plating material : Sn

Date code (2 digit)

1st digit		2nd digit	
Year of production		Month of production	
A.D.	Mark	Month	Mark
2000	0	1	1
2001	1	2	2
2002	2	3	3
2003	3	4	4
2004	4	5	5
2005	5	6	6
2006	6	7	7
2007	7	8	8
2008	8	9	9
2009	9	10	X
2010	0	11	Y
:	:	12	Z

repeats in a 10 year cycle

Country of origin

Japan

■ Absolute Maximum Ratings ($T_a=25^\circ\text{C}$)

Parameter	Symbol	Rating	Unit
Supply voltage	V_{CC}	-0.5 to +7	V
Output voltage	V_O	30	V
*1 Output current	I_{OL}	50	mA
*2 Operating temperature	T_{opr}	-10 to +70	$^\circ\text{C}$
*2 Storage temperature	T_{stg}	-20 to +80	$^\circ\text{C}$

*1 Sink current refer to Fig.5.

*2 The connector should be plugged in/out at normal temperature.

■ Electro-optical Characteristics ($T_a=25^\circ\text{C}$)

Parameter	Symbol	Conditions	MIN.	TYP.	MAX.	Unit
Supply voltage	V_{CC}	-	4.75	-	5.25	V
Current dissipation (I)	I_{CC}	Smoothing value $V_{CC}=5\text{V}$, $R_L=\infty$	-	-	30	mA
*3 Current dissipation (II)	I_{CCP}	Pulse peak value $V_{CC}=5\text{V}$	-	-	150	mA
Low level output voltage	V_{OL}	$V_{CC}=5\text{V}$, $I_{OL}=16\text{mA}$, at detecting time	-	-	0.4	V
High level output voltage	V_{OH}	$V_{CC}=5\text{V}$, $R_L=1\text{k}\Omega$, at non detecting time	4.5	-	-	V
*4 Non detection distance	L_{LHL}	KODAK Gray Cards, $V_{CC}=5\text{V}$	-	-	90	mm
GP2A210LCSJF			-	-	70	
*4 Detection distance	L_{HLS}	KODAK Gray Cards, $V_{CC}=5\text{V}$	-	-	2	mm
		Black paper, $V_{CC}=5\text{V}$	-	-	5	
	L_{HLL}	KODAK Gray Cards, $V_{CC}=5\text{V}$	22	-	-	mm
		Black paper, $V_{CC}=5\text{V}$	15	-	-	
*5 Response time	t_{PLH}	$V_{CC}=5\text{V}$	-	-	1	ms
	t_{PHL}		-	-	1	ms
*6 Acceptable illuminance	Ev1	-	3 000	-	-	lx
	Ev2		1 500	-	-	lx

*3 Refer to Fig.1.

*4 Refer to Fig.2.

*5 Refer to Fig.3.

*6 Refer to Fig.4.

Reflective object Black paper (black) : Standard reflective object (provided by SHARP Corporation)
 KODAK Gray Cards (use the white side reflects about 90%)
 : Standard reflective object (provided by SHARP Corporation)
 PPC paper : Standard reflective object (provided by SHARP Corporation)

Fig.1 Test Condition for Peak Pulse Value I_{CCP}

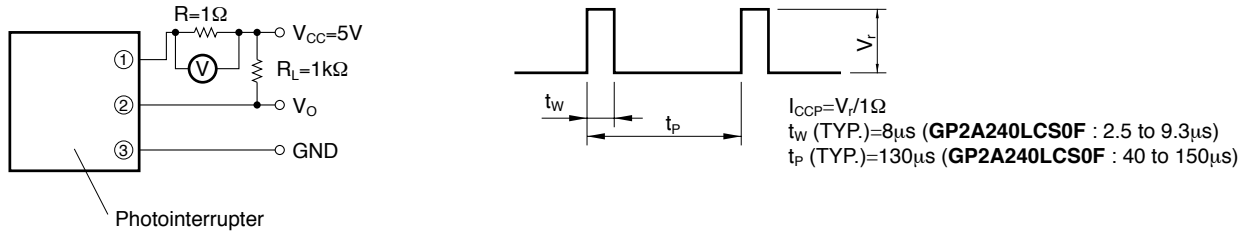

Fig.2 Test Condition for Detecting Distance Characteristics

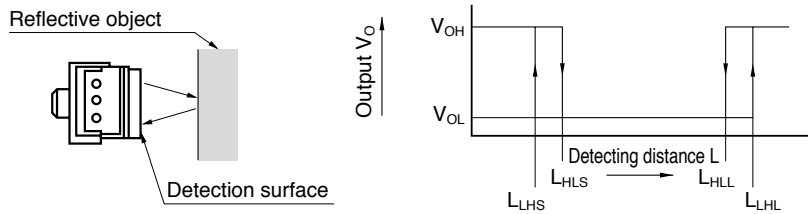

Fig.3 Test Circuit for Response Time

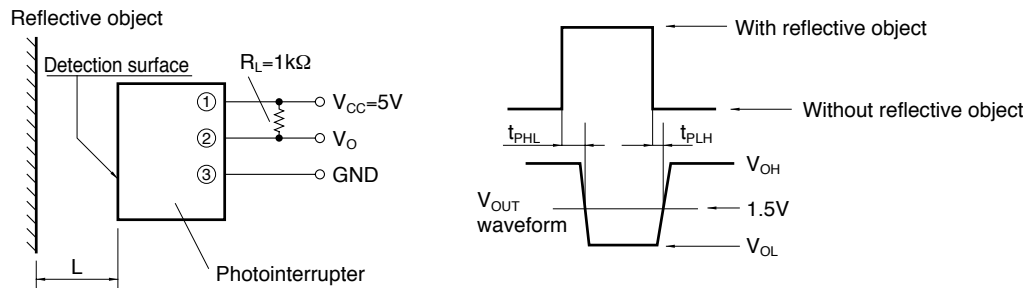

Fig.4 Test Condition for External Disturbing Light Illuminance

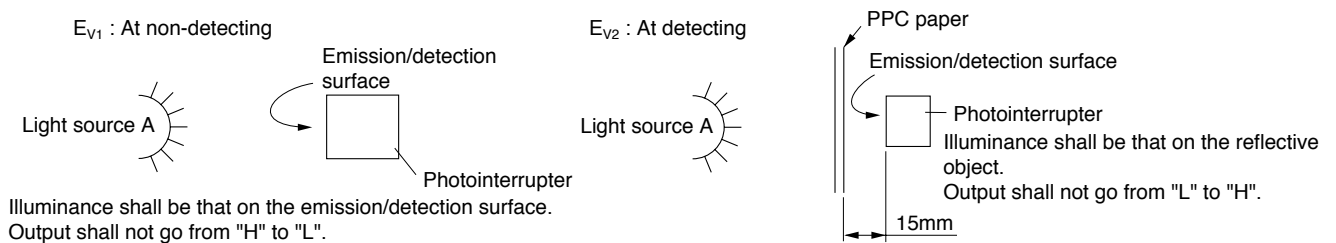

Fig.5 Output Current vs. Ambient Temperature

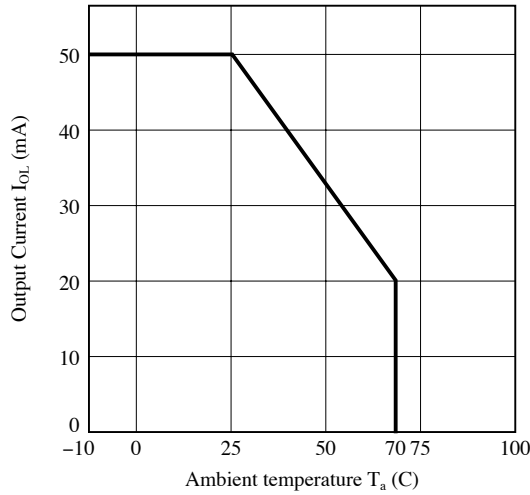

Fig.6 Low Level Output Voltage vs. Ambient Temperature

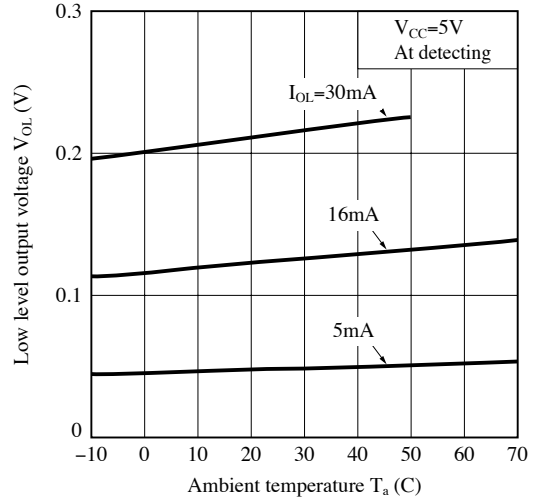

Fig.7 Low Level Output Voltage vs. Low Level Output Current

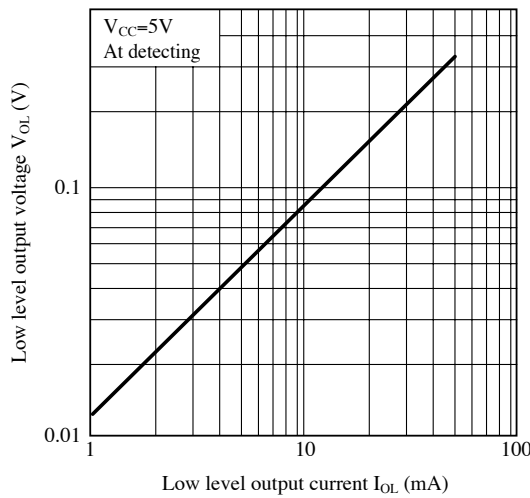
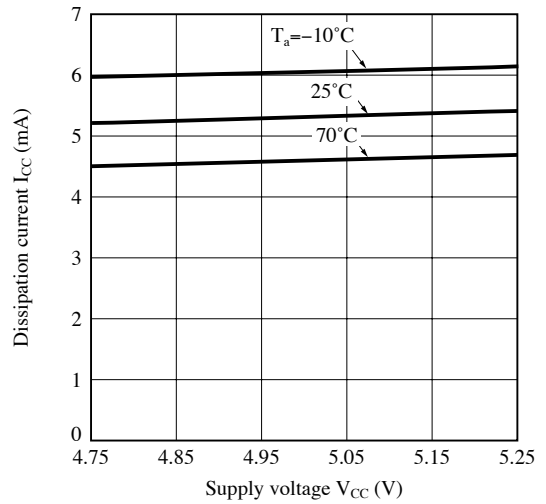

Fig.8 Dissipation Current(Smoothing Value) vs. Ambient Temperature



Remarks : Please be aware that all data in the graph are just for reference and not for guarantee.

■ **Design Considerations**

● **Design guide**

1) V_O terminal : Open collector output

This product operates the light emitter by pulse drive. Please supply the stable supply voltage in order to prevent error operation by pulse current.

Please use this device after connecting a capacitor between V_O and GND for prevention of line noise.

2) Prevention of detection error

Please be careful that you need to keep the direct inverter light away from the photo detecting surface since the device will not operate correctly in such case.

In addition, we recommend to make sure the operation test in the actual application.

3) Plugging in/out

The connector should be plugged in/out at normal temperature.

This product is not designed against irradiation and incorporates non-coherent IRED.

● **Parts**

This product is assembled using the below parts.

• Photodetector (Q'ty : 1) [Using a silicon photodiode as light detecting portion, and a bipolar IC as signal processing circuit]

Category	Maximum Sensitivity wavelength (nm)	Sensitivity wavelength (nm)	Response time (μs)
Phototransistor	900	700 to 1 200	400

• Photo emitter (Q'ty : 1)

Category	Material	Maximum light emitting wavelength (nm)	I/O Frequency (MHz)
Infrared emitting diode (non-coherent)	Gallium arsenide (GaAs)	950	0.3

• Material

	Case	Lens	Bottom cover
GP2A200LCS0F	Black polyphenylene Sulfide resin (UL94 V-0)	Polycarbonate resin (UL94 V-2)	Polycarbonate resin (Gray) (UL94 V-2)
GP2A200LCSCF			
GP2A210LCSJF*			Polycarbonate resin (Navy Blue) (UL94 V-2)
GP2A240LCS0F			

*The IR-90 filter (Fuji Photo Film Co., Ltd.) is inserted between case and detector side lens.

• Others

Laser generator is not used.

■ Manufacturing Guidelines**● Cleaning instructions**

Polycarbonate resin is used as the material of the lens surface. So this product shall not be cleaned by cleaning solvent absolutely. Dust and stain shall clean by air blow, or shall clean by soft cloth.

● Presence of ODC

This product shall not contain the following materials.

And they are not used in the production process for this product.

Regulation substances : CFCs, Halon, Carbon tetrachloride, 1.1.1-Trichloroethane (Methylchloroform)

Specific brominated flame retardants such as the PBBOs and PBBs are not used in this product at all.

This product shall not contain the following materials banned in the RoHS Directive (2002/95/EC).

•Lead, Mercury, Cadmium, Hexavalent chromium, Polybrominated biphenyls (PBB), Polybrominated diphenyl ethers (PBDE).

■ Package specification**● Case package**

Package materials

Anti-static plastic bag : Polyethylene

Moltopren : Urethane

Packing case : Corrugated fiberboard

Package method

100 pcs of products shall be packaged in a plastic bag, Ends shall be sealed by stapler. The bottom of the packing case is covered with moltopren, and 2 plastic bags shall be put into the packing case.

Moltopren should be located after all product are settled (1 packing contains 200 pcs).

Packing composition

