

# GP2S700HCP

SMT, Detecting Distance : 3mm  
Phototransistor Output,  
Compact Reflective  
Photointerrupter



## ■ Description

**GP2S700HCP** is a compact-package, phototransistor output, reflective photointerrupter, with emitter and detector facing the same direction in a molding that provides non-contact sensing. The compact package series is formed by epoxy resin, that also blocks visible light to minimize false detection.

This device has a long focal distance for this family of devices and has a leadless (T&R) package, suitable for reflow soldering.

## ■ Features

1. Reflective with Phototransistor Output
2. Highlights :
  - Compact Size
  - Surface Mount Type (SMT), reflow soldering
  - Tape and Reel (T&R) 1 000 pcs per reel
3. Key Parameters :
  - Optimal Sensing Distance : 3mm
  - Package : 4×3×2mm
  - Visible light cut resin to prevent
4. RoHS directive compliant

## ■ Agency approvals/Compliance

1. Compliant with RoHS directive

## ■ Applications

1. Detection of object presence or motion.  
Example : printer, optical storage

Notice The content of data sheet is subject to change without prior notice.  
In the absence of confirmation by device specification sheets, SHARP takes no responsibility for any defects that may occur in equipment using any SHARP devices shown in catalogs, data books, etc. Contact SHARP in order to obtain the latest device specification sheets before using any SHARP device.

■ Internal Connection Diagram

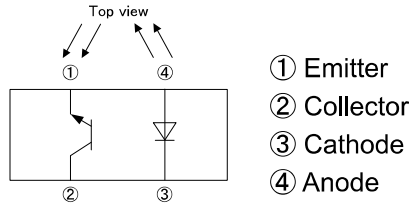

■ Outline Dimensions (Unit : mm)

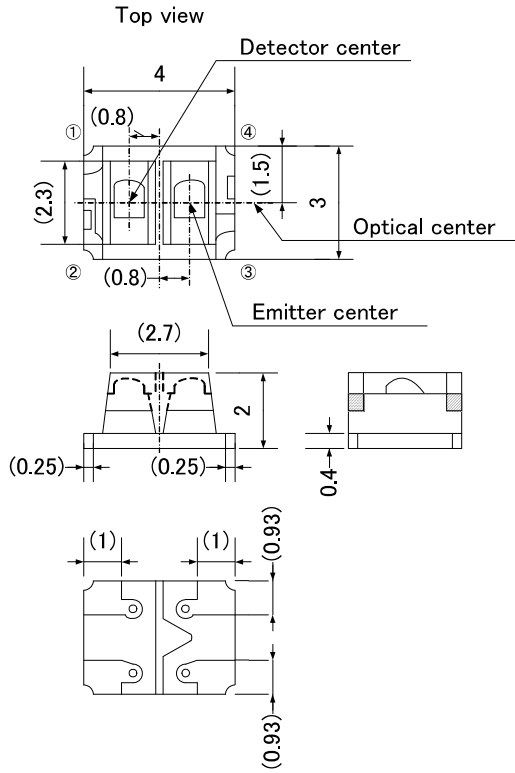

- Unspecified tolerance :  $\pm 0.3\text{mm}$ .
- Dimensions in parenthesis are shown for reference.
- Dimensions on the outline drawing is the maximum value excluding burr.
- The dimensions shown do not include burr.
- Burr's dimension : 0.15mm MAX.

Product mass : approx. 0.01g

Plating material : Au

## ■ Absolute Maximum Ratings (T<sub>a</sub>=25°C)

Parameter		Symbol	Rating	Unit
Input	Forward current	I <sub>F</sub>	50	mA
	Reverse voltage	V <sub>R</sub>	6	V
	Power dissipation	P <sub>D</sub>	75	mW
Output	Collector-emitter voltage	V <sub>CEO</sub>	35	V
	Emitter-collector voltage	V <sub>ECO</sub>	6	V
	Collector current	I <sub>C</sub>	20	mA
	Collector power dissipation	P <sub>C</sub>	75	mW
Total power dissipation		P <sub>tot</sub>	100	mW
Operating temperature		T <sub>opr</sub>	-25 to +85	°C
Storage temperature		T <sub>stg</sub>	-40 to +100	°C
*1 Soldering temperature		T <sub>sol</sub>	260	°C

\*1 For 5s or less

## ■ Electro-optical Characteristics (T<sub>a</sub>=25°C)

Parameter		Symbol	Condition	MIN.	TYP.	MAX.	Unit
Input	Forward voltage	V <sub>F</sub>	I <sub>F</sub> =20mA	-	1.2	1.4	V
	Reverse current	I <sub>R</sub>	V <sub>R</sub> =6V	-	-	10	μA
Output	Collector dark current	I <sub>CEO</sub>	V <sub>CE</sub> =20V	-	1	100	nA
Transfer characteristics	*2 Collector current	I <sub>C</sub>	I <sub>F</sub> =4mA, V <sub>CE</sub> =2V	60	-	410	μA
	*3 Leak current	I <sub>LEAK</sub>	I <sub>F</sub> =4mA, V <sub>CE</sub> =2V	-	-	700	nA
	Response time	Rise time	t <sub>r</sub>	V <sub>CE</sub> =2V, I <sub>C</sub> =100μA, R <sub>L</sub> =1kΩ, d=4mm	-	20	100
Fall time		t <sub>f</sub>	-		20	100	

\*2 The condition and arrangement of the reflective object are shown below.

\*3 Without reflective object.

### ● Test Condition and Arrangement for Collector Current

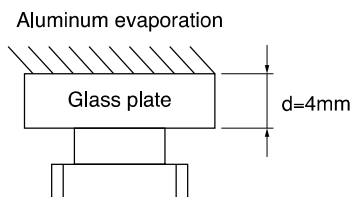

**Fig.1 Forward Current vs. Ambient Temperature**

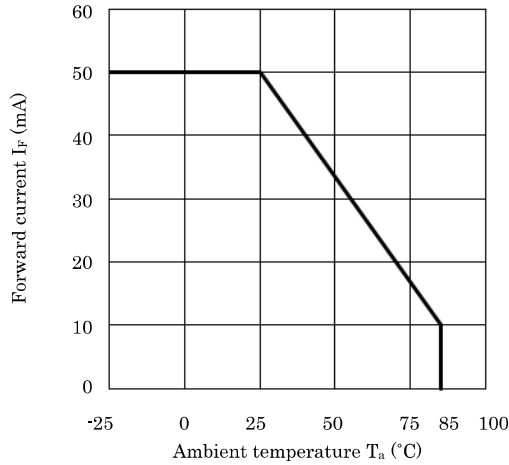

**Fig.2 Collector Power Dissipation vs. Ambient Temperature**

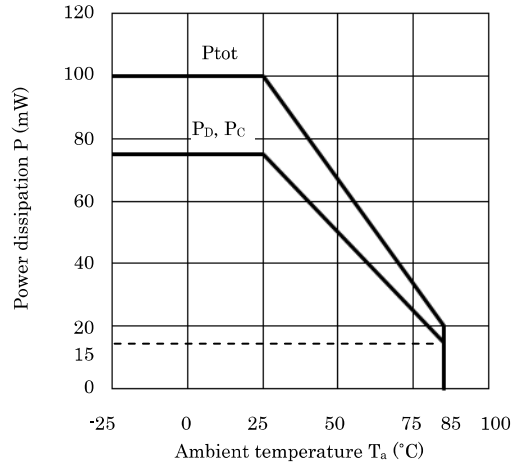

**Fig.3 Forward Current vs. Forward Voltage**

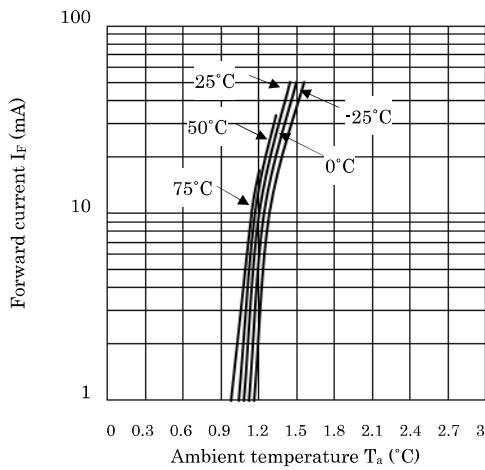

**Fig.4 Collector Current vs. Forward Current**

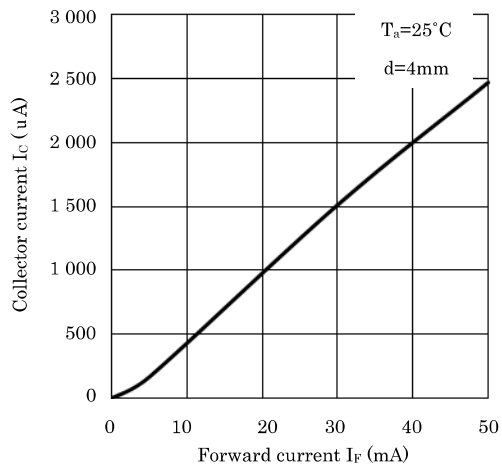

**Fig.5 Collector Dark Current vs. Ambient Temperature**

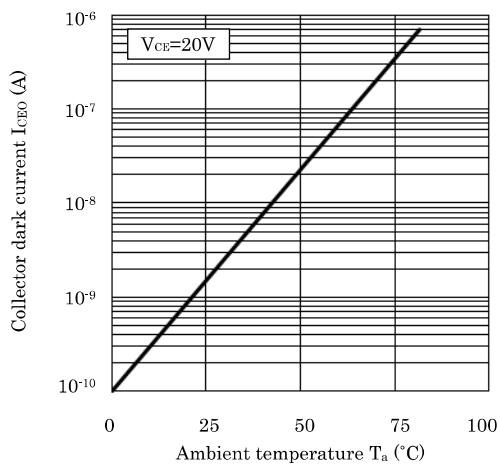

**Fig.6 Response Time vs. Load Resistance**

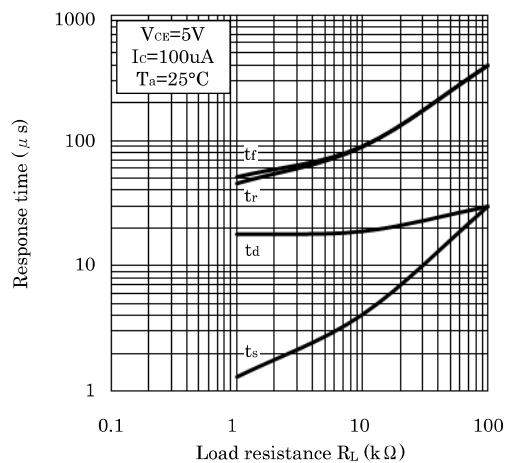

**Fig.7 Test Circuit for Response Time**

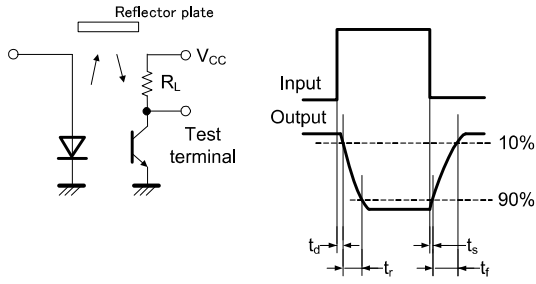

**Fig.8 Relative Collector Current vs. Distance**

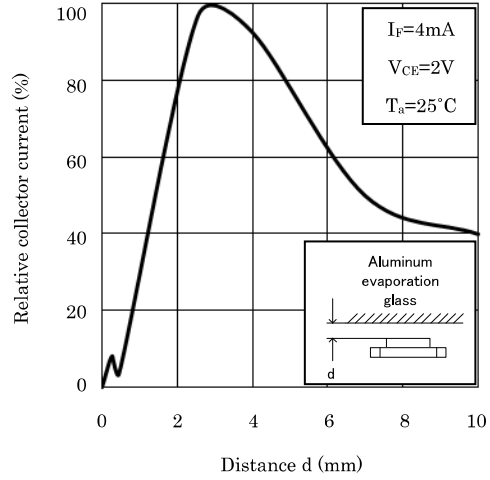

**Fig.9 Relative Collector Current vs. Ambient Temperature**

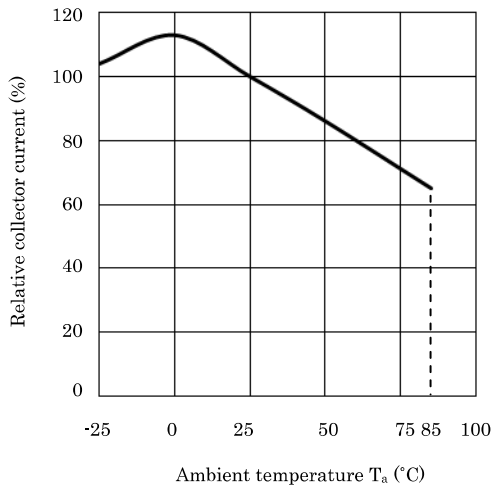

Remarks : Please be aware that all data in the graph are just for reference and not for guarantee.

**■ Design Considerations**

**● Design guide**

1) Regarding to prevention of malfunction

To prevent photointerrupter from faulty operation caused by external light, do not set the detecting face to the external light. Also, if some other electronic components are located close to this device, false operation may occur.

(The light reflection caused by the other components may slip into the photodetecting portion of the device and if may cause false operation.)

2) Distance characteristic

The distance between the photointerrupter and the object to be detected shall be determined the distance by referencing Fig.8 "Relative collector current vs. distance".

3) For wiring on a mounting PCB

To avoid possibility for short, please do not apply pattern wiring on the back side of the device.

4) Regarding to mounting this product

There is a possibility that the opaque molded resin portion may have a crack by force at mounting etc. Please use this product after well confirmation of conditions in your production line.

And please confirm the mounting workability beforehand when using the automatic mounting machine.

This product is not designed against irradiation and incorporates non-coherent IRED.

**● Degradation**

In the case of long term operation, please take the general IRED degradation (50% degradation over 5 years) into the design consideration.

**● Parts**

This product is assembled using the below parts.

• Light detector (qty. : 1)

Category	Material	Maximum Sensitivity wavelength (nm)	Sensitivity wavelength (nm)	Response time (μs)
Phototransister	Silicon (Si)	930	700 to 1 200	20

• Light emitter (qty. : 1)

Category	Material	Maximum light emitting wavelength (nm)	I/O Frequency (MHz)
Infrared light emitting diode (non-coherent)	Gallium arsenide (GaAs)	950	0.3

• Material

Case	PCB	Lead frame plating
Black epoxy resin	Glass epoxy resin	Au plating

## ● Recommended pattern

(Unit : mm)

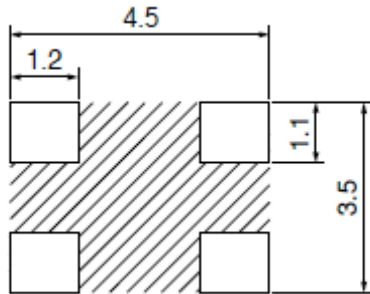
measure tolerance :  $\pm 0.1$ 

area : Please do not apply the pattern wiring to avoid the possibility of short circuit.

Regarding amount of solder, if there is solder leakage in terminal wiring pattern between PCB and housing main body, the reliability will be deteriorated.

Please check the proper amount of solder in advance not to have solder leakage into terminal wiring pattern between PCB and housing main body.

---

**■ Manufacturing Guidelines****● Storage and management after open****Storage condition**

Storage temp.: 5 to 30°C, Storage humidity : 70%RH or less at regular packaging.

**Treatment after opening the moisture-proof package**

After opening, you should mount the products while keeping them on the condition of 5 to 25°C and 60%RH or less in humidity within 2 days.

After opening the bag once even if the prolonged storage is necessary, you should mount the products within two weeks.

And when you store the rest of products you should put into a DRY BOX. Otherwise after the rest of products and silicagel are sealed up again, you should keep them under the condition of 5 to 30°C and 70%RH or less in humidity.

**Baking before mounting**

When the above-mentioned storage method could not be executed, please process the baking treatment before mounting the products.

However the baking treatment is permitted within one time.

Recommended condition : 125°C, 16 to 24 hours

\*Do not process the baking treatment with the product wrapped. When the baking treatment processing, you should move the products to a metallic tray or fix temporarily the products to substrate.



● **Soldering Method**

Reflow Soldering:

Reflow soldering should follow the temperature profile shown below.  
 Soldering should not exceed the curve of temperature profile and time.  
 Please solder within one time.

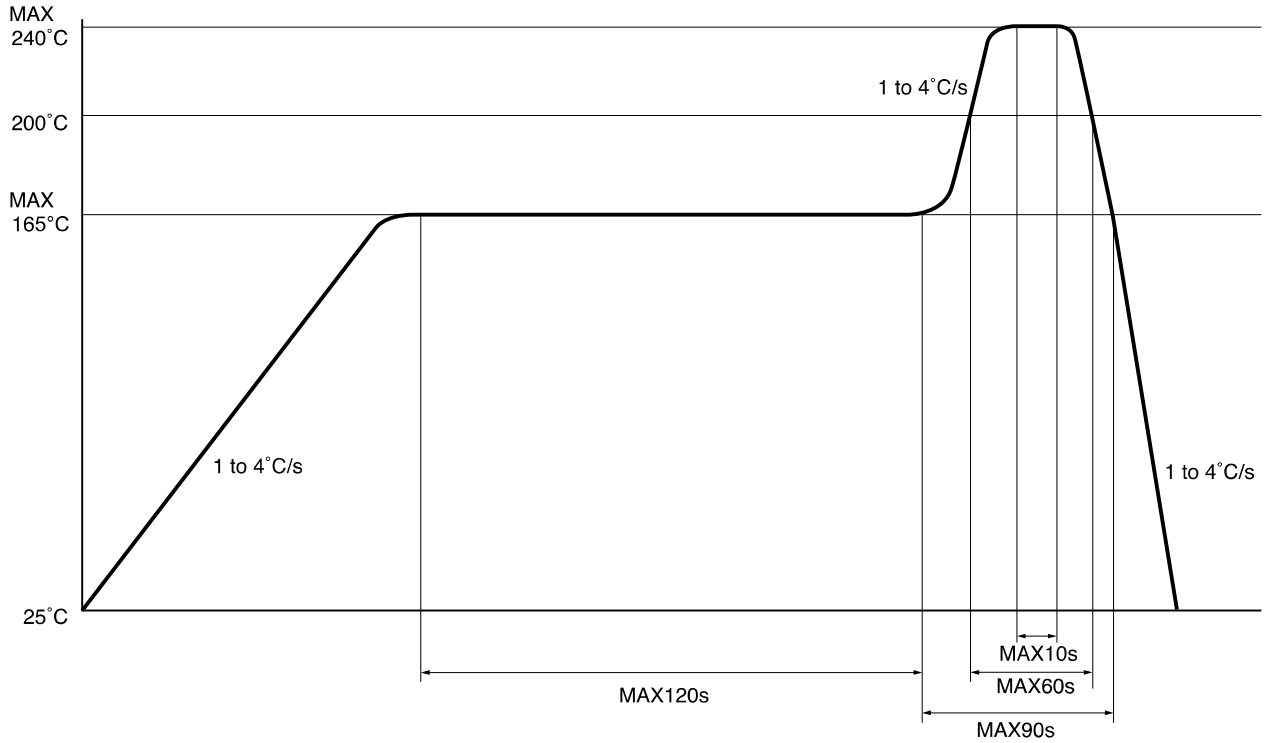

Other notice

Please take care not to let any external force exert on lead pins.  
 Please test the soldering method in actual condition and make sure the soldering works fine, since the impact on the junction between the device and PCB varies depending on the cooling and soldering conditions.

● **Cleaning instructions**

Solvent cleaning :

Solvent temperature should be 45°C or below. Immersion time should be 3 minutes or less.

Ultrasonic cleaning :

Do not execute ultrasonic cleaning.

Recommended solvent materials :

Ethyl alcohol, Methyl alcohol and Isopropyl alcohol.

### ● Presence of ODC

This product shall not contain the following materials.

And they are not used in the production process for this product.

Regulation substances : CFCs, Halon, Carbon tetrachloride, 1.1.1-Trichloroethane (Methylchloroform)

Specific brominated flame retardants such as the PBBOs and PBBs are not used in this product at all.

This product shall not contain the following materials banned in the RoHS Directive (2002/95/EC).

- Lead, Mercury, Cadmium, Hexavalent chromium, Polybrominated biphenyls (PBB), Polybrominated diphenyl ethers (PBDE).

Content of six substances specified in Management Methods for Control of Pollution Caused by Electronic Information Products Regulation (Chinese : 电子信息产品污染控制管理办法).

Category	Toxic and hazardous substances					
	Lead (Pb)	Mercury (Hg)	Cadmium (Cd)	Hexavalent chromium (Cr <sup>6+</sup> )	Polybrominated biphenyls (PBB)	Polybrominated diphenyl ethers (PBDE)
Photointerrupter	✓	✓	✓	✓	✓	✓

✓ : indicates that the content of the toxic and hazardous substance in all the homogeneous materials of the part is below the concentration limit requirement as described in SJ/T 11363-2006 standard.

■ **Package specification**

● **Tape and Reel package**

Package materials

Reel : PS

Package method

1 000 pcs of products shall be packaged in a reel. One reel is enclosed in aluminum laminated bag.

After sealing up the bag, it is enclosed in one case (5 bags/case).

Carrier tape structure and Dimensions

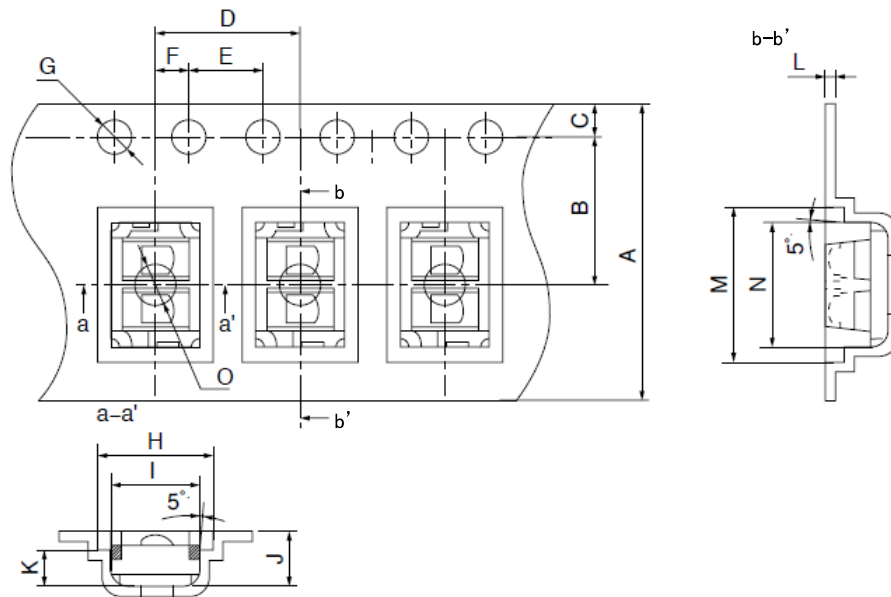

Dimension List

(Unit : mm)

A	B	C	D	E	F	G	H
12 <sup>±0.3</sup>	5.5 <sup>±0.05</sup>	1.75 <sup>±0.1</sup>	8 <sup>±0.1</sup>	4 <sup>±0.1</sup>	2 <sup>±0.1</sup>	φ1.55 <sup>±0.05</sup>	5.2 <sup>±0.1</sup>
I	J	K	L	M	N	O	
3.2 <sup>±0.2</sup>	2.2 <sup>±0.1</sup>	1.2 <sup>±0.1</sup>	0.3 <sup>±0.05</sup>	6.3 <sup>±0.1</sup>	4.2 <sup>±0.2</sup>	φ1.6 <sup>±0.1</sup>	

Reel structure and Dimensions

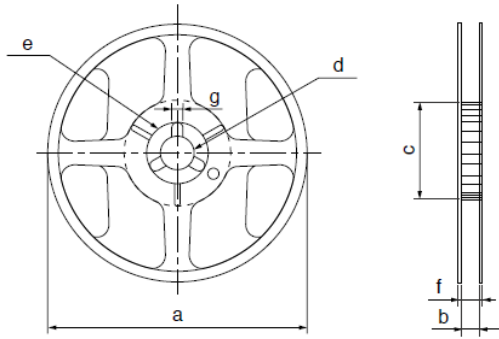

Dimension List		(Unit : mm)	
a	b	c	d
180 <sup>±1.5</sup>	13 <sup>±1.0</sup>	60 <sup>+0.5</sup> <sub>-0</sub>	Φ13 <sup>±0.2</sup>
e	f	g	
Φ21 <sup>±0.8</sup>	15.4 <sup>±1.0</sup>	2 <sup>+0.3</sup> <sub>-0</sub>	

Direction of product insertion

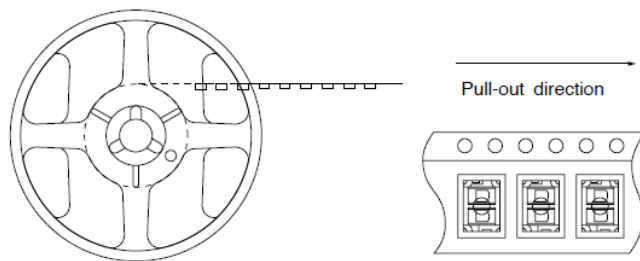

[Packing : 1 000pcs/reel]

Storage method

Storage conditions should follow the condition shown below.

Storage temperature : 5 to 30°C

Storage humidity : 70%RH or less