



GP30-DEV-KIT

GP30-DEV-KIT-F01

Development Kit User Guide

GP30-DEV-KIT Guide

Revision: 4

Release Date: 2023-05-16

Document Status: Production

Content Guide

Content Guide	2
1 Introduction	3
1.1 Ordering Codes	3
2 Quick Start Guide	4
2.1 Install the Software	4
2.2 Install the Hardware	4
2.3 Quick Start for Initial Measurements	4
3 Hardware Description	6
3.1 Introduction	6
3.2 Communication Interface	6
4 Software Description	7
4.1 Measurement.....	7
4.1.1 First Step with Measurement Control Elements.....	7
4.1.2 Time of Flight Measurement Results.....	8
4.1.3 2-Wire Temperature Measurement Results	9
4.2 Ultrasonic Measurement Control	10
4.3 Temperature Measurement Control	11
4.4 General Control.....	12
4.4.1 Firmware.....	12
4.5 Interfaces.....	13
4.5.1 Pulse Interface.....	13
4.5.2 UART.....	13
4.6 Interrupt & Error Handling	14
4.7 acam	14
4.8 Firmware Parameters and Firmware Error Counters	15
5 Software Menu	16
5.1 File	16
5.2 Tools.....	16
5.3 Firmware	18
5.4 Help	22
6 Schematics, Layers & BOM	24
7 RoHS Compliance & SciSense Green Statement	27
8 Copyrights & Disclaimer	27
9 Revision information	28

1 Introduction

The GP30-DEV-KIT is a platform for a quick and easy start-up and evaluation of the TDC-GP30 ultrasonic flow converter (UFC). It supports the QFN32 package, which offers the functionality need for standard water and heat meters. The development kit offers user-friendly configuration and extensive testing of the TDC-GP30, but also the complete assembler environment for programming the device. For a proper use of the evaluation system, we strongly recommend referring to the latest TDC-GP30 datasheets. The kit includes three elements:

GP30-DEMO-US / GP30-DEMO-US-F01 reference board, based on TDC-GP30YD (-F01) in QFN32 package



PicoProg Lite with USB-C – USB cable

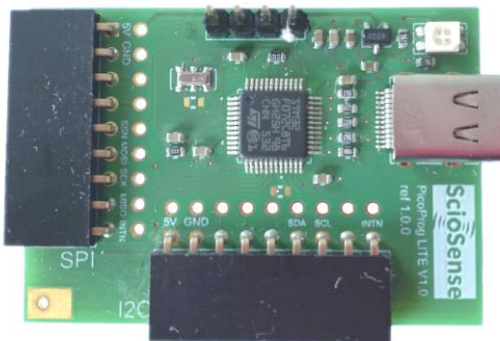

Figure 1: Functional Blocks

Please download the software for the kit from <https://downloads.sciosense.com/tdc-gp30/> and look for the latest revision of TDC-GP30_EvalSW.

1.1 Ordering Codes

Table 1: Pin description

Ordering code	Part Number	Description
GP30-DEV-KIT	220260003	TDC-GP30YD Demo kit including PicoProg Lite and cable
GP30-DEV-KIT-F01	220260006	TDC-GP30YDF01 Demo kit including PicoProg Lite and cable

GP30-DEMO-US	220260002	TDC-GP30YD Reference board
GP30-DEMO-US-F01	220260005	TDC-GP30YD-F01 Reference board

2 Quick Start Guide

This section describes how to quickly set up the GP30-DEV-KIT, establish basic operation and make measurements.

2.1 Install the Software

It is crucial to install the software before connecting the evaluation kit to your computer. A default driver loading of your OS may interfere with correct installation.

- Download the latest zipped software installation package to the desired directory.
- Unzip the package to the desired directory.
- Open “setup.exe” from the unzipped directory.
- Follow the instructions on the screen.

2.2 Install the Hardware

- Make sure software is installed correctly before proceeding with this step!
- Connect your computer with the PicoProg Lite using USB cable.
- Connect PicoProg Lite and the evaluation kit reference board.
- The green LED on the evaluation kit should be on.
- Connect your spool piece to US_UP and US_DOWN

2.3 Quick Start for Initial Measurements

From the “Start” menu, go to “All Programs” and then to the “SciSense” directory. Double click the “GP30_v2_0” icon (or newer versions, if available) to begin execution of the evaluation software. The following screen should appear:

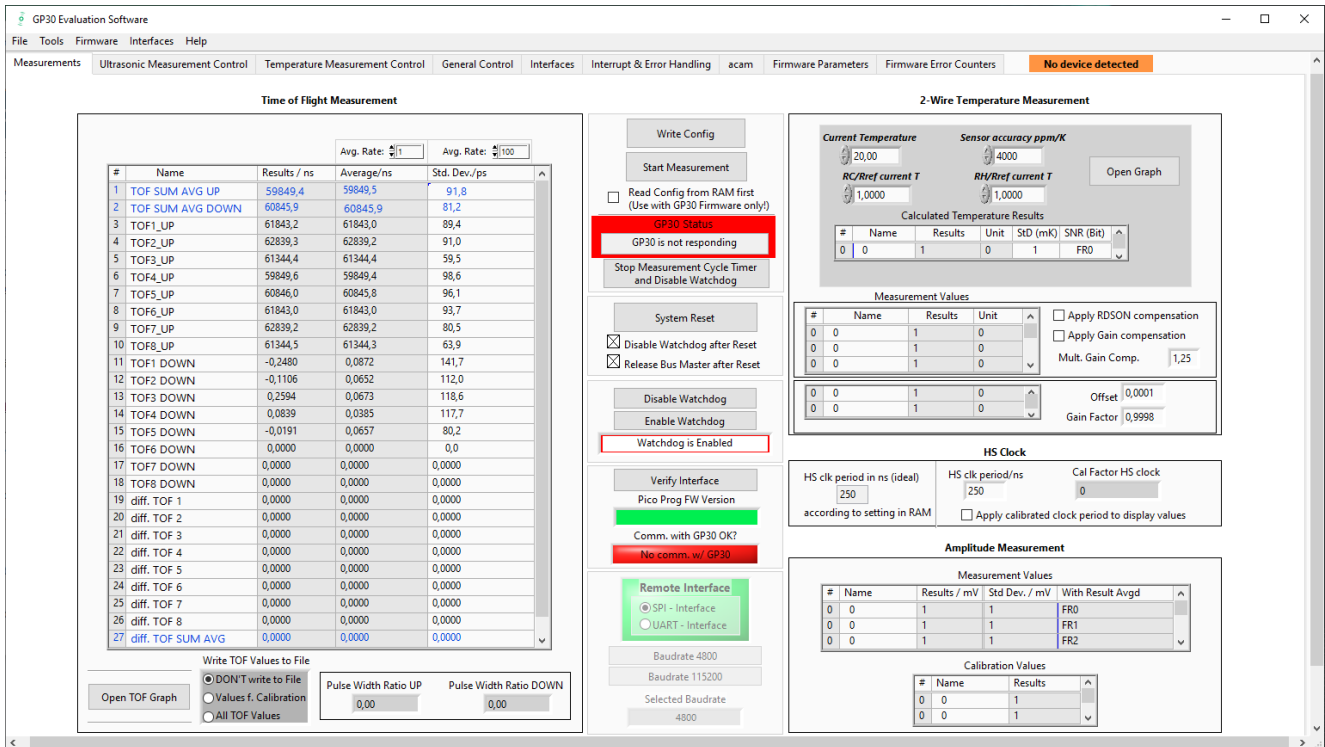

Figure 2: Functional Blocks

- Click the “Verify Interface” button to confirm communication between PicoProg Lite and TDC-GP30 is working. Both fields, “Pico Prog Lite FW version” and “Comm. With GP30 OK?”, should become green.
- Next, open our initial configuration GP30Y_config_default_03 and download it into the chip, pressing “Write Config”.
- Connect your spool piece to pins US_UP and US_DOWN. Depending on the outline of the transducers changes of the configuration will be necessary.
- Press “Start Measurement” to begin measuring.

At this point, after successful completion of the above steps, a basic operation of the DEV kit should be possible. The following sections provide a detailed description of the hardware and software for advanced operation.

3 Hardware Description

3.1 Introduction

The GP30-DEV MODULE board, shown in Figure 3, is a front-end for a water or heat meters. The transducers and temperature sensors are directly connected to this board. It comes with a 32.768 kHz quartz (X2) and a 4 MHz ceramic oscillator (X1). All ports of TDC-GP30 are available. Additional patch fields allow an easy extension with additional circuits. Those can be amplifiers or analog switches for operation in gas meter mode.

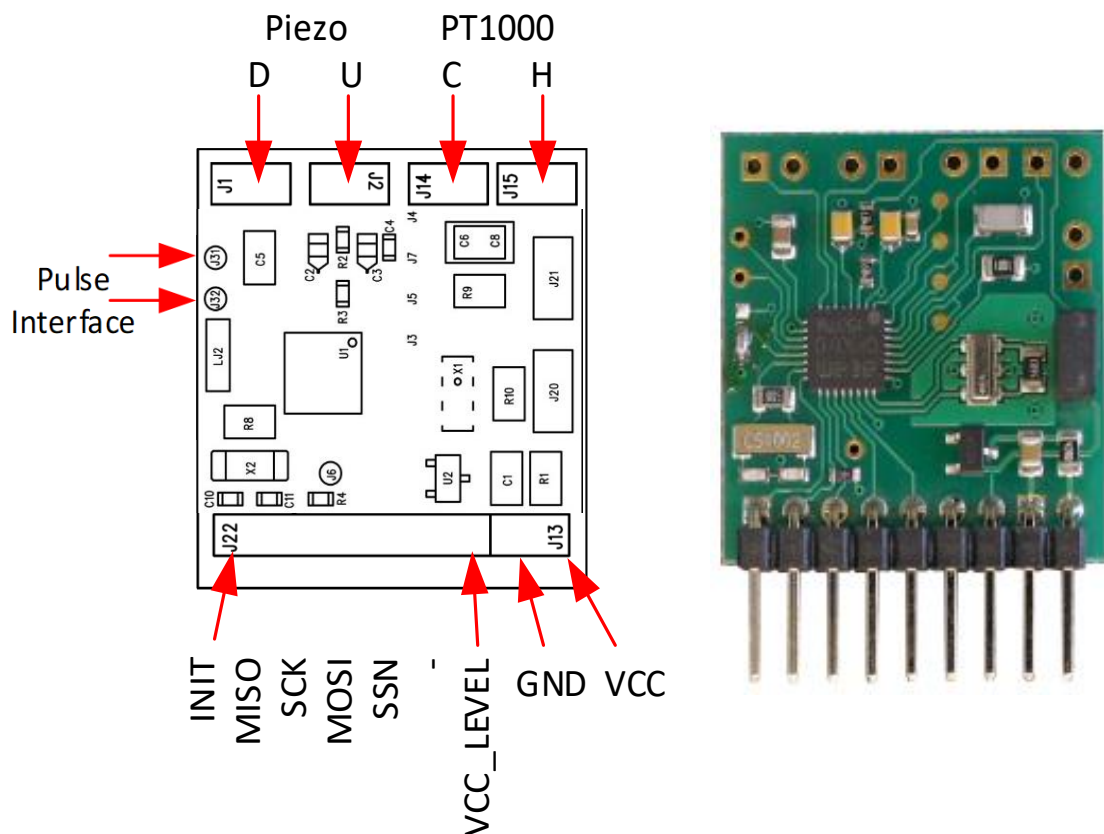

Figure 3: GP30-DEV MODULE

3.2 Communication Interface

The PicoProg Lite board is a USB-to-SPI converter box that interfaces all UFC evaluation systems.

The PicoProg Lite is registered by the operating system initially as “PicoProg LITE V1.0”. To confirm, open “Control Panel” of your OS and click on “Devices and Printers” icon. The USB driver will be listed in “Unspecified” driver section.

The flat connector includes the power lines and the SPI or UART communication lines. The development kit with PicoProg Lite does not support UART communication.

On the demo board the communication interface is initially selected to SPI (by solder bridge LJ2). Pin VCC_LEVEL is the voltage feedback for the former PICOPROG level shifters and is no longer used with PicoProg Lite.

4 Software Description

4.1 Measurement

When started, the software comes up with the main window, showing the “Measurements” tab.

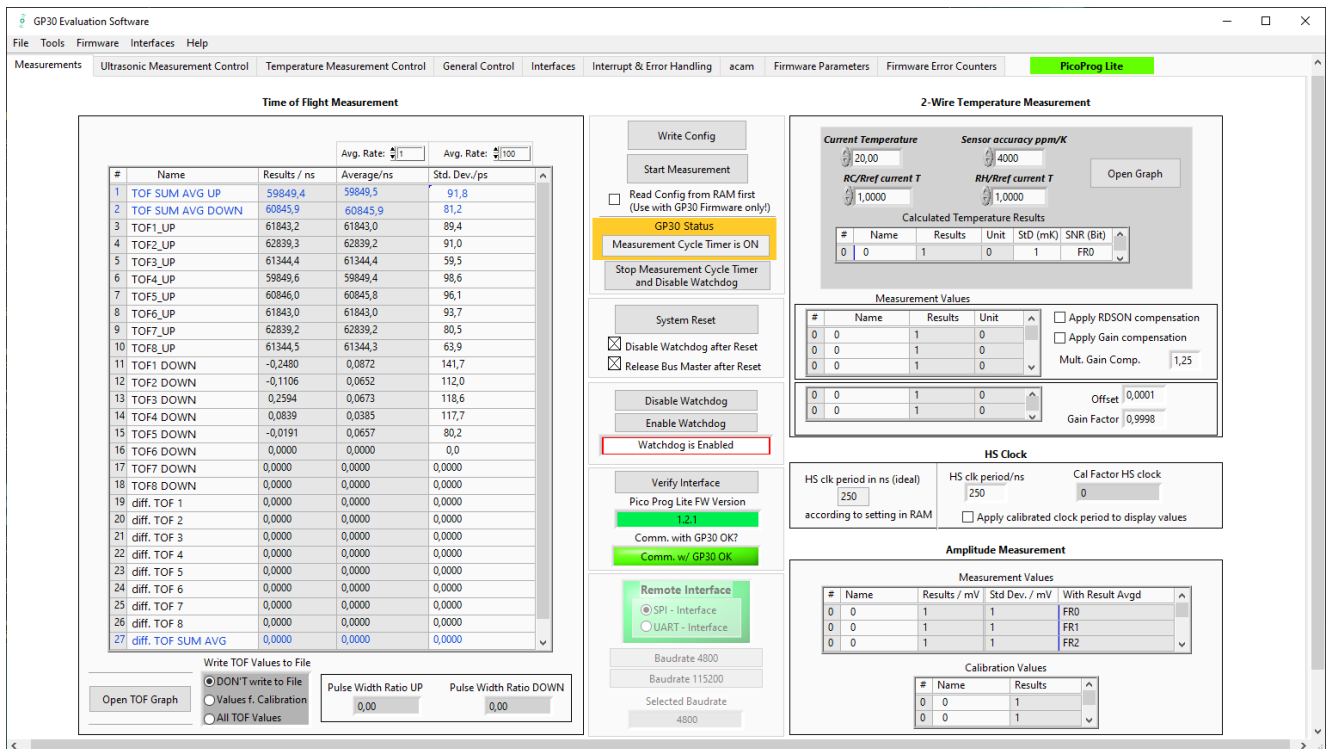

4.1.1 First Step with Measurement Control Elements

A good first step is to load a working configuration and make measurements in frontend mode (without using the internal 32-Bit μ P). SciSense provides a sample configuration file named GP30Y_config_default_03 which typically works well with DN20 spool pieces.

Load Configuration File: File menu → Open Config → choose appropriate configuration file

1. Press “System Reset” button. Now the Pico Prog Lite FW version field should get green and the appropriate version should be displayed (1.2.1 or higher). Further, “Comm GP30 OK?” should get green to show that communication with TDC-GP30 works.
2. If watchdog is not disabled by “System Reset”. Button press “Disable Watchdog” button.
3. Press “Write Config” button to download the configuration settings into TDCX-GP30.
4. Press “Start Measurement” button. Now the chip starts to measure and the software displays the results in the table “Time of Flight Measurements”.

The user can now modify the configuration to fit it to his needs. Having done this, the user can store his own configuration files.

4.1.2 Time of Flight Measurement Results

GP30 stores the first 8 hits of every TOF direction separately and also the averaged sum of all measured hits calculated by UI (in blue). These 9 results are displayed for both directions, as we call them up and down. The evaluation software additionally calculates the difference (in blue) between up and down stream, DIFF-TOF. In total, all 27 results are displayed in the “Results” column.

In the “Average” column the user can set the sample size for the averaging (<1000). The software calculates the rolling average of the results accordingly. In “Std. Dev.” column the standard deviation, calculated over a variable sample size, is displayed. The number of samples can be chosen (e.g. 100).

The same is done with the amplitude values of the receiving signals and the pulse width ratio between first hit and start hit. The values for both directions are displayed.

Information: The application of the highspeed calibration is off by default. This is more convenient when comparing measurement data. But when collecting data for calibration it is strongly recommended to have this active.

HS Clock		
HS clk period in ns (ideal) 250 according to setting in RAM	HS clk period/ns 249,6	Cal Factor HS clock 0,998418
<input type="checkbox"/> Apply calibrated clock period to display values		

Figure 5: HS Clock Calibration

A graph to display TOF measurement results opens in a separate window by pressing “TOF Graph” button. It is possible to activate up to four plots. Each plot has various selections, e.g. TOF1UP, TOF2UP etc.. Always averaged values are displayed.

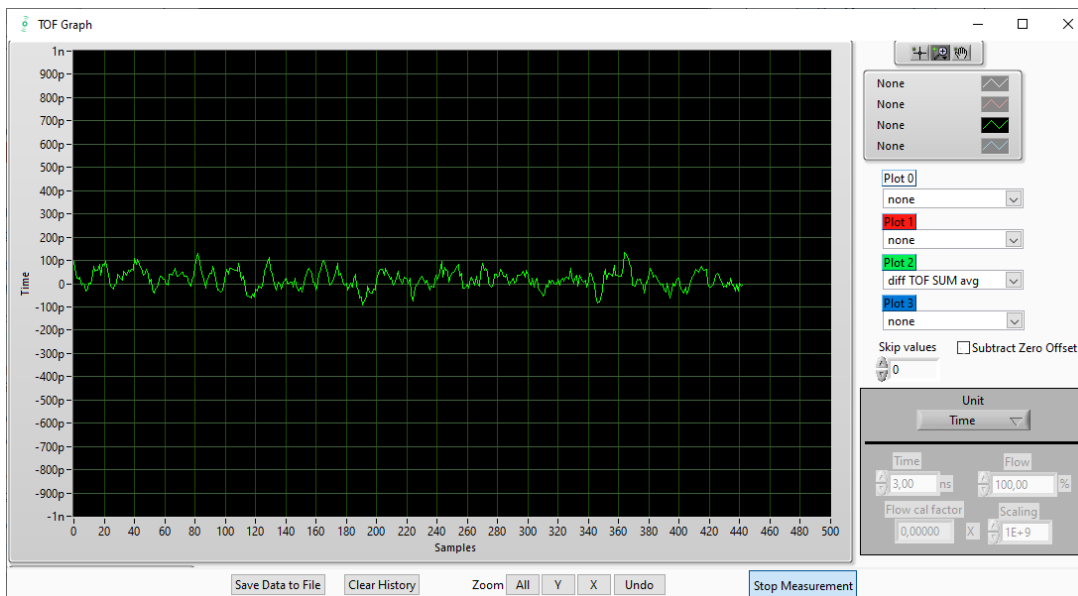

Figure 6: TOF Graph

4.2 Ultrasonic Measurement Control

In this tab the user makes all settings for an appropriate ultrasonic measurement. They group as follows:

- Time of Flight Sequence Control
- Time of Flight Hit Control
- Amplitude Measurement Control
- Transducer Interface Options

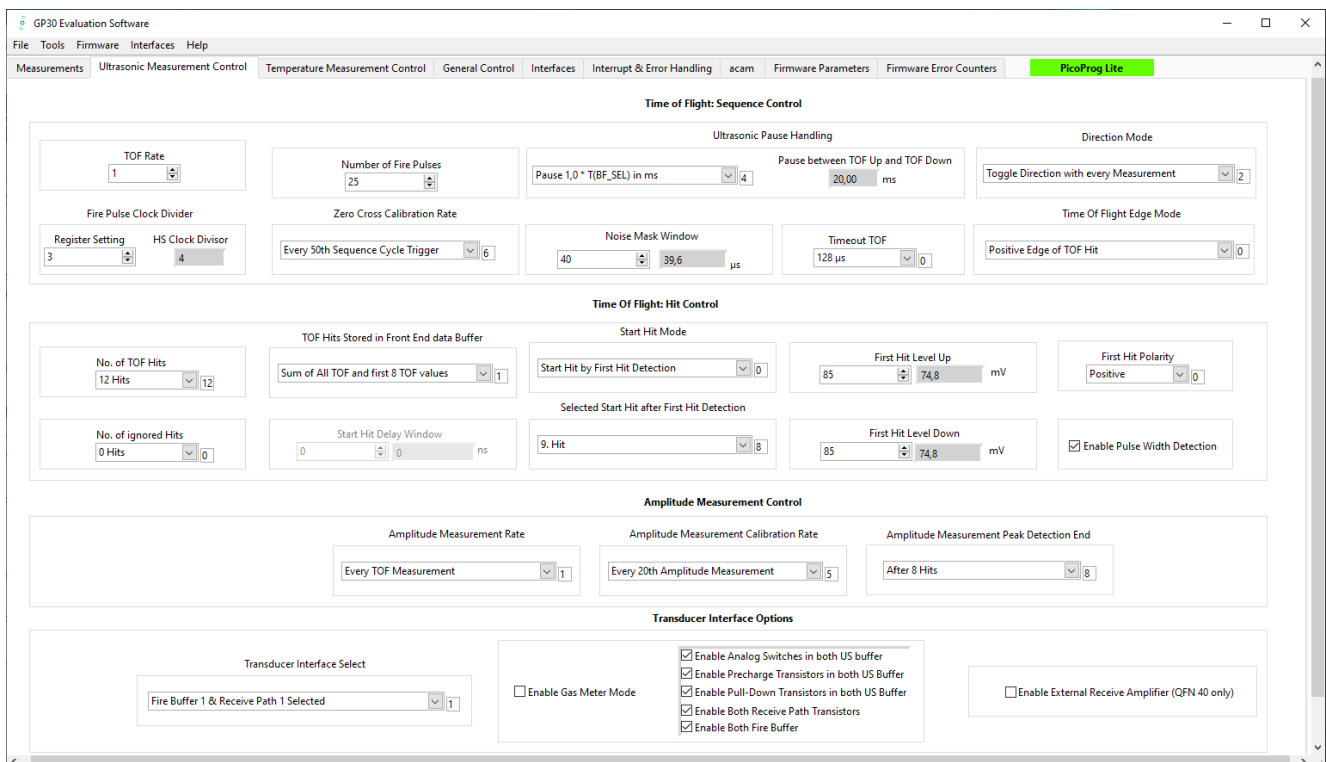

Figure 10: Ultrasonic Measurement Control Tab

The meanings of the various settings are displayed in clear text. For more details about the register settings please refer to the GP30 manual.

4.3 Temperature Measurement Control

All settings for an appropriate temperature measurement are done in this tab, which are grouped as follows:

- Sequence Control
- Measurement Control
- Temperature Measurement Cycle Time

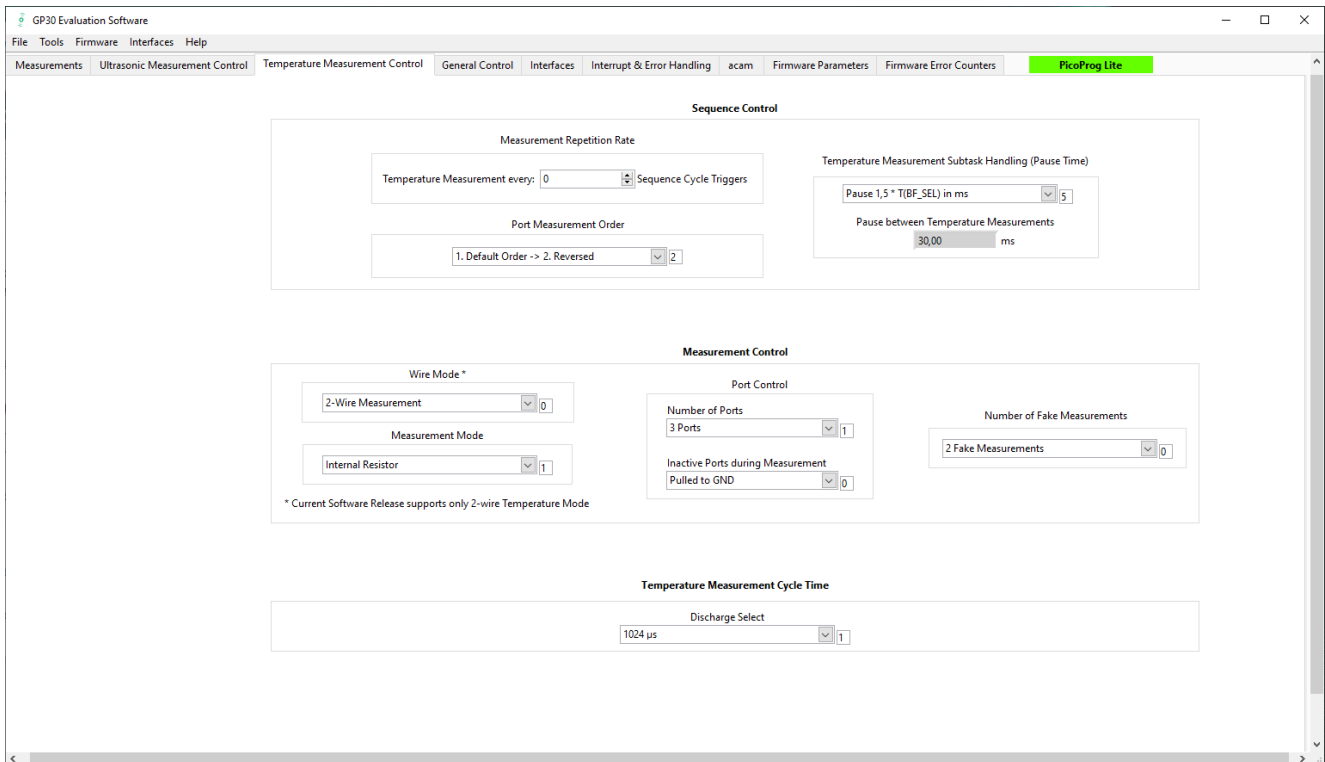

Figure 11: Temperature Measurement Control Tab

The meanings of the various settings are displayed in clear text. For more details about the register settings please refer to the GP30 manual.

4.4 General Control

The “General Control” tab covers configuration settings for

- Task sequencing
- High speed clock control
- Voltage measurement
- CPU handling
- Timer settings

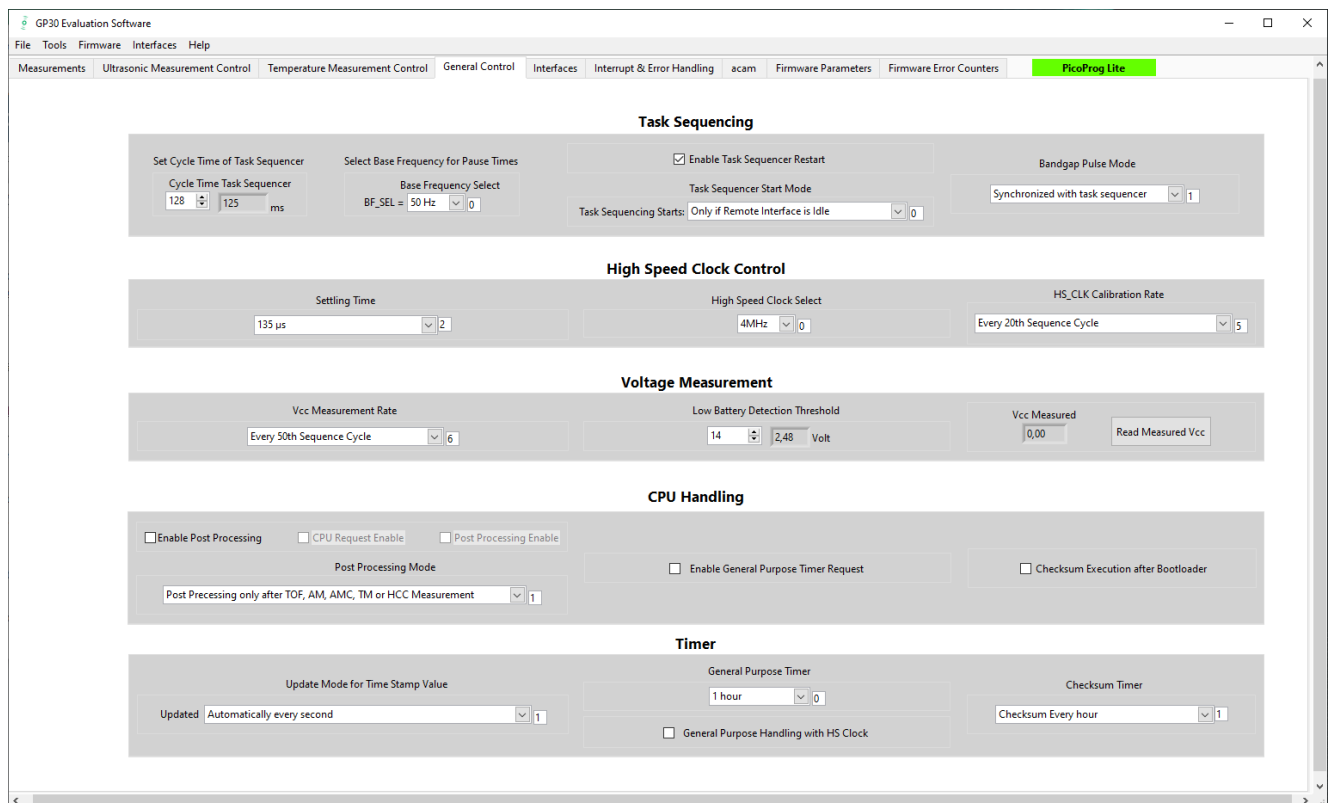

Figure 12: General Control Tab

The meanings of the various settings are displayed in clear text. For more details about the register settings please refer to the GP30 manual

4.4.1 Firmware

In case the TDC-GP30 has firmware, setting flag “Enable post processing” turns on the CPU (flow meter mode). Having this not set, the GP30 runs as front-end in time conversion mode.

4.5 Interfaces

The “Interfaces” tab covers configuration settings for

- Pulse interface including test option
- EEPROM interface
- GPIO control
- UART remote interface.

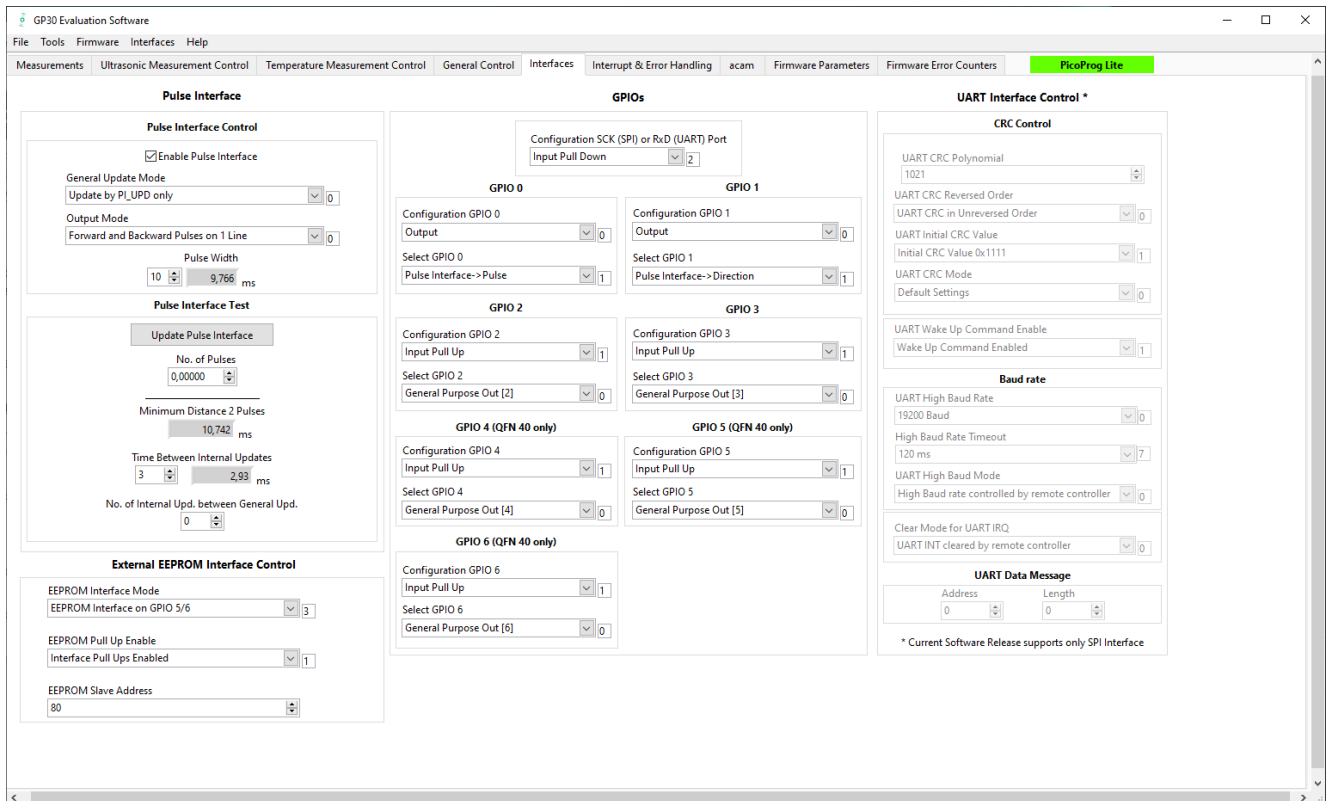

Figure 13: Interfaces Tab

The meanings of the various settings are displayed in clear text. For more details about the register settings please refer to the GP30 manual.

4.5.1 Pulse Interface

The pulse interface needs an appropriate firmware in the chip. The settings in the evaluation software only generate an artificial pulse to test the general functionality. The output is not related to any measurement.

4.5.2 UART

The UART is not supported in this software version.

4.6 Interrupt & Error Handling

On this tab error indicators and interrupt sources for remote interface can be selected.

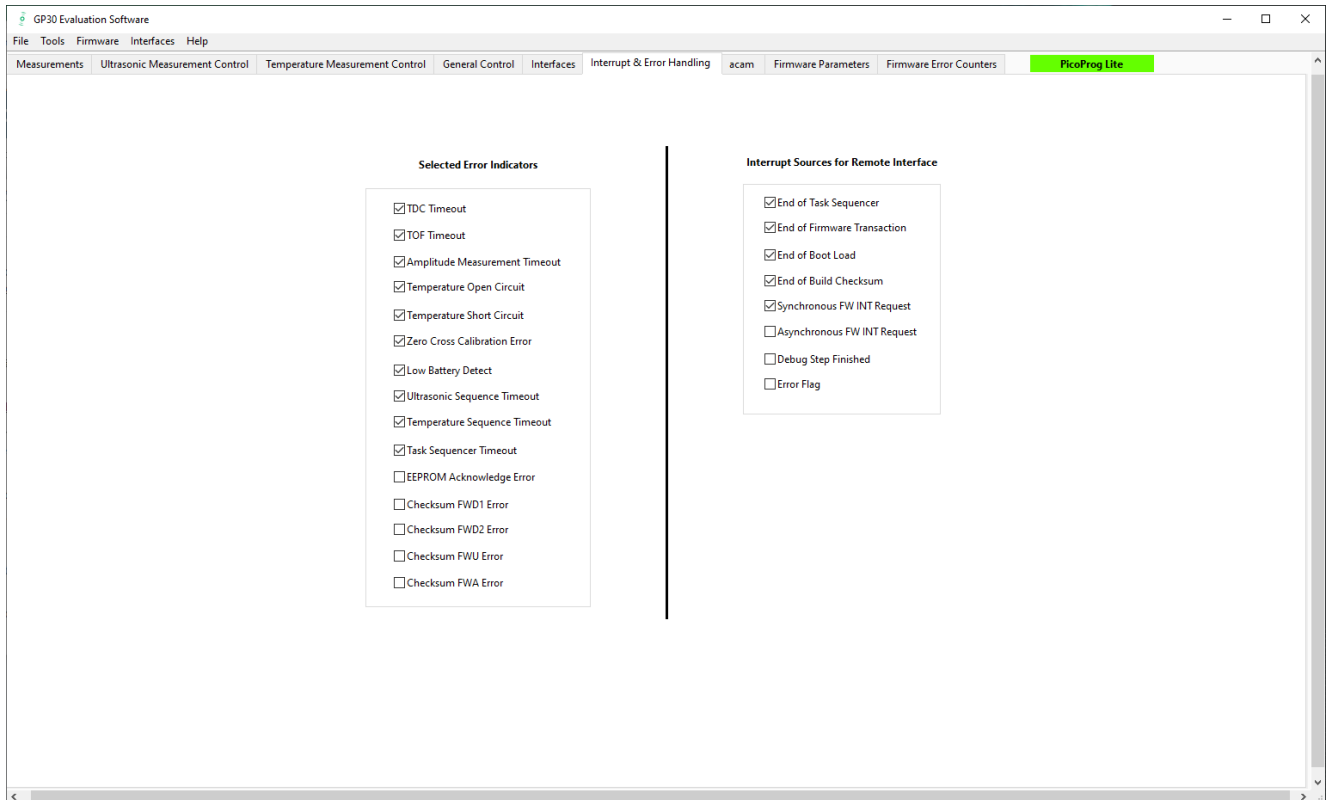

Figure 14: Interrupt and Error Handling

The meanings of the various settings are displayed in clear text. For more details about the register settings please refer to the GP30 manual.

4.7 acam

On this tab specific parameters are displayed, but for ScioSense internal use and analysis only.

4.8 Firmware Parameters and Firmware Error Counters

Those two tabs display and allow editing of parameters related to the SciSense flow firmware. They are of use only for TDC-GP30-F01.

For details please refer to the application note TDC-GP30-F01 Flow Firmware (SC-001268-AN).

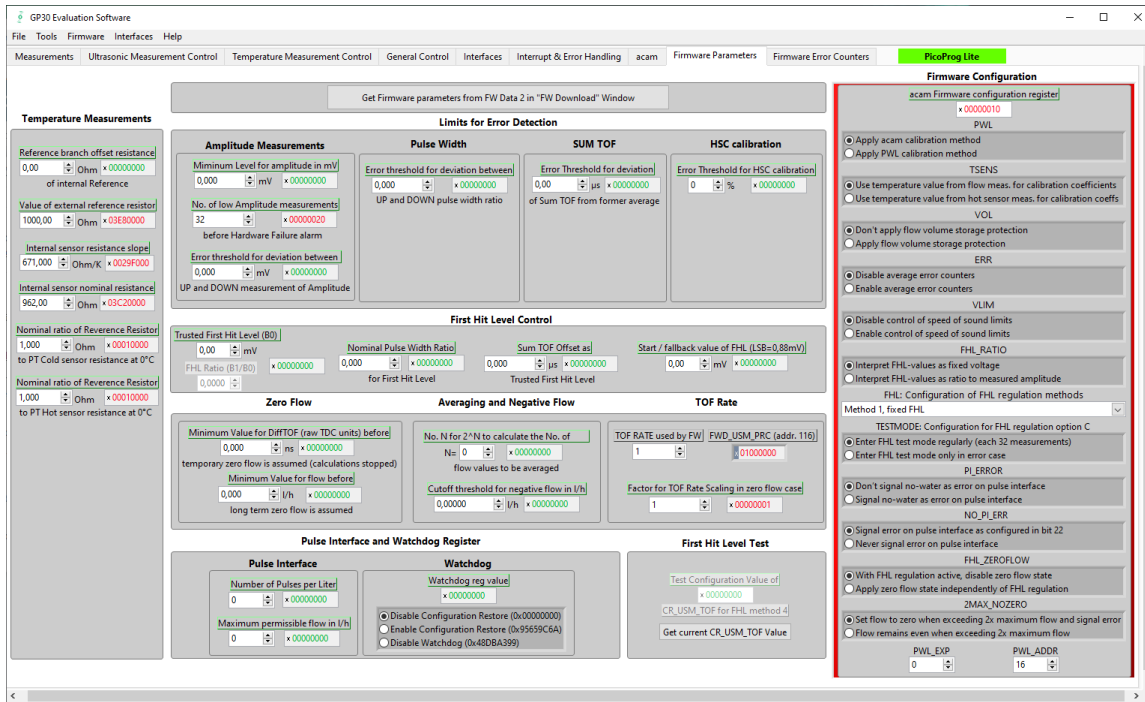

Figure 15: Firmware Parameters Tab

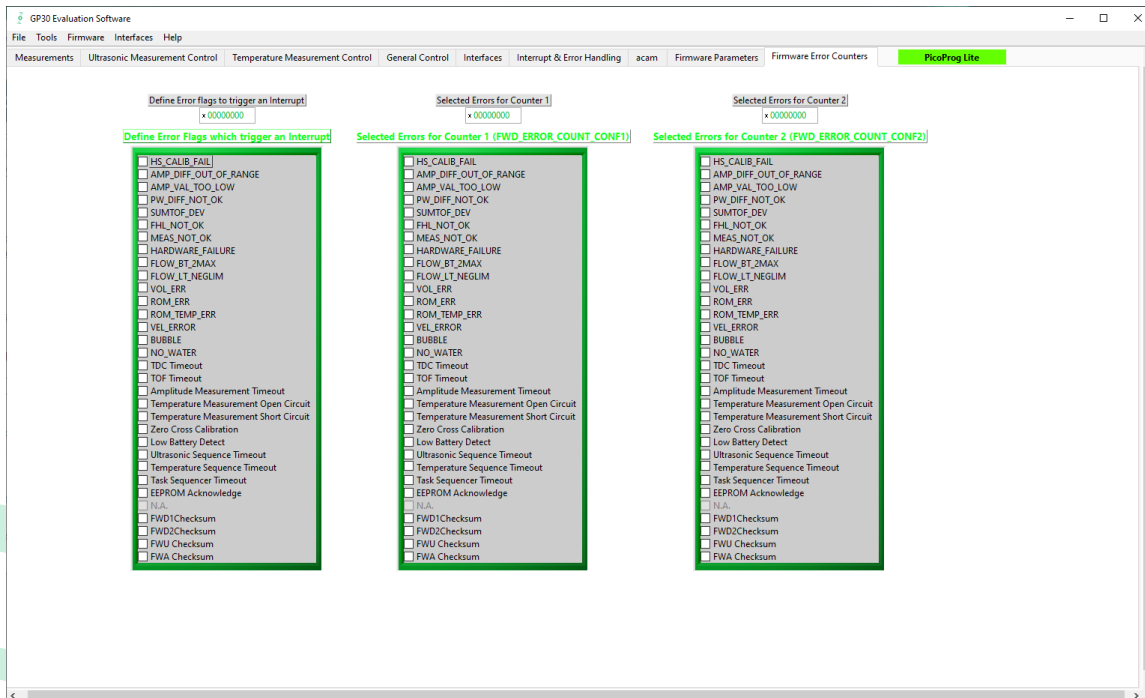

Figure 16: Firmware Error Counters

5 Software Menu

Beside main window, the software menu allows the opening of other windows. There are some menu items which are redundant to available buttons of main window.

5.1 File

- **Open Config**
This dialog box allows the path selection of a configuration file, covering the register settings, necessary for a proper configuration of the GP30. After opening this file, the control settings are updated in the GUI.
- **Save Config**
This menu item allows the saving of the current GUI control settings into a configuration file
- **Close**
Close all open windows of the GP30 Evaluation software.

5.2 Tools

- **Run Measurement**
Same function as “Start/Stop Measurement” button in “Measurement” tab of main window.
- **TOF Graph**
Same function as “Open TOF Graph” button in “Measurement” tab of main window.
- **Temperature Graph**
Same function as “Open Graph” button for temperature measurement in “Measurement” tab of main window.
- **RAM Memory**
Opens a window which allows single write and read accesses to random access area for addresses 0x000 - 0x0FF.
The random access area from 0x100 - 0x17F, containing the firmware data, can be accessed separately by “Firmware Download” window

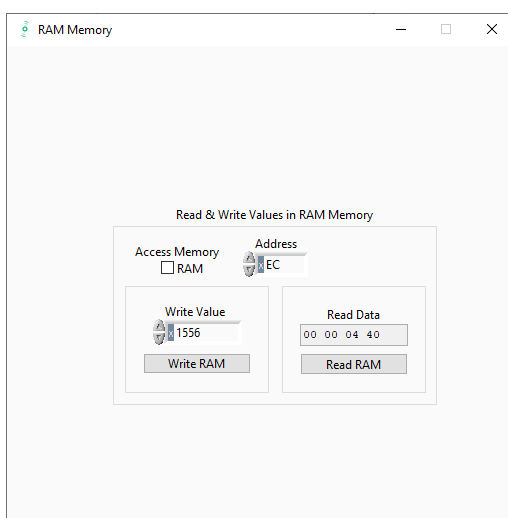

Figure 17: Firmware Parameters Tab

- Registers

Opens a window, which shows the registers important for a proper configuration setting of the GP30. In the left column, the register contents correspond to the settings done in tabs of GUI main window. If the button “Read GP30 Register Settings” is pressed, the configuration settings located in TDC-GP30 registers are displayed in the right column, by pressing “Read and Transfer” button, the register settings in the tabs of main window and in the left column of this window are updated with the register settings from right column.

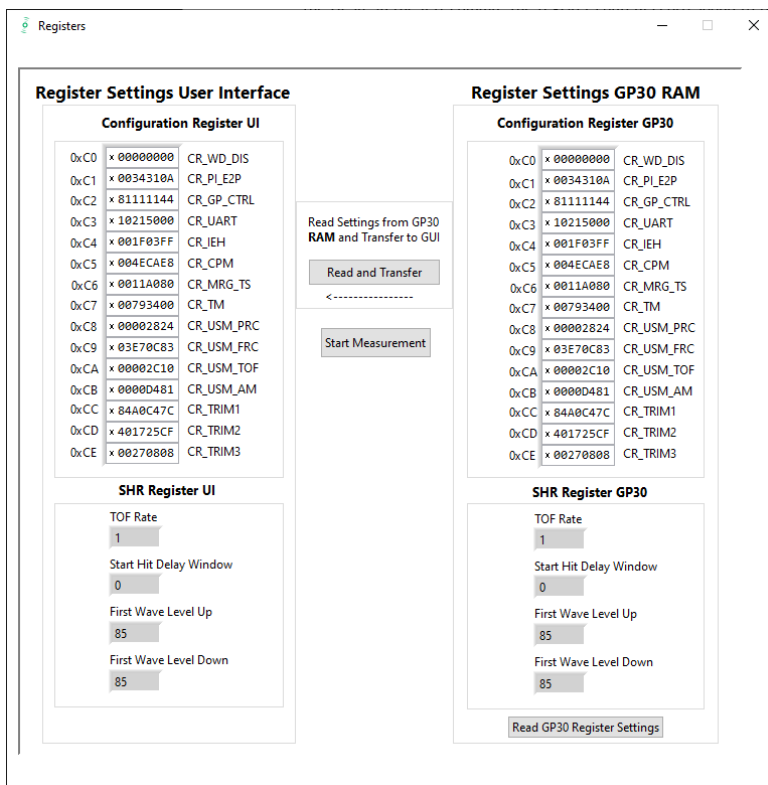

Figure 18: Registers

Remote Commands

This window summarizes some additional commands, which can be executed via remote interface. System Reset: Executes a complete system reset of GP30. Same function as “System Reset” button in “Measurement” tab of main window

- System Init: Same function as “System Reset” without clearing the configuration (CR_...) and the system handling (SHR_...) register.
- CPU Init: Clears the CPU block in GP30
- SV Init: Clears the supervisor block in GP30
- FEP Init: Clears the frontend processing block in GP30
- Request/Release Bus Master: Allows the request of the bus master in GP30, e.g. if the random access bus is blocked by a deadlock, caused by an improper firmware download.
- Measure Cycle Timer Off/On: Stop & start of the measure cycle timer
- Clear Interrupt Flags: Clears all bits in SRR_IRQ_FLAG register
- Communication Request: Allows an asynchronous demand by remote controller to get an interrupt by GP30, signaling the time for remote communication.

- General Purpose Request: Allows an asynchronous request by remote controller to initiate a general purpose handling in in firmware of integrated GP30 CPU.

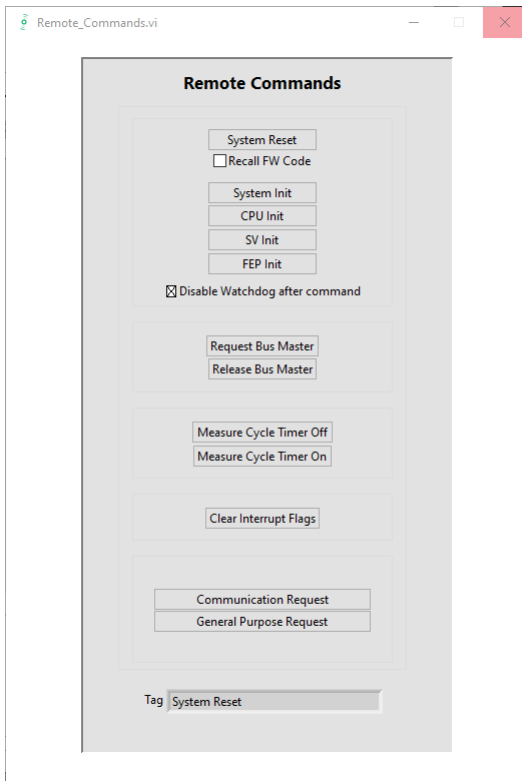

Figure 19: Remote Commands

5.3 Firmware

- Assembler
The TDC-GP30 assembler is integrated into the GP30 evaluation software. It is opened in the Firmware menu of the main program:

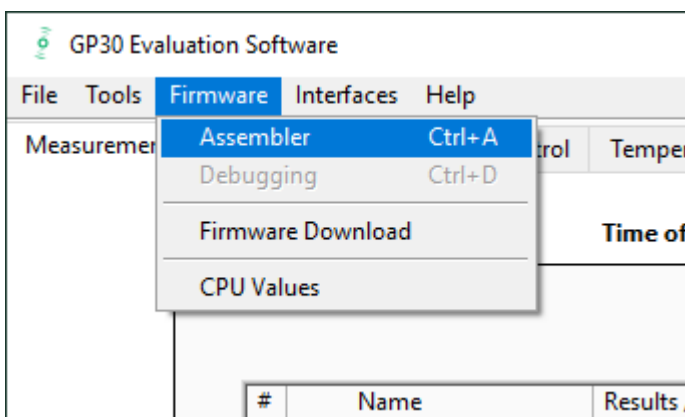

Figure 20: Firmware Menu

The following window comes up:

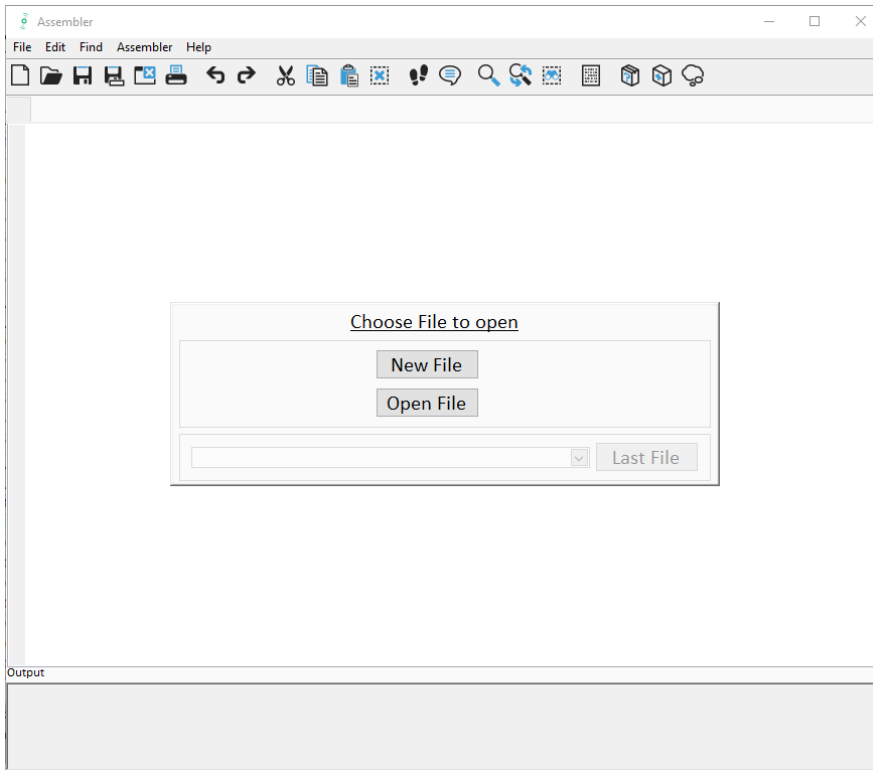

Figure 21: Assembler Window

This is a comfortable editor with syntax highlighting, search and replace, copy and paste functions.

Under menu item “Assembler” the user finds the compile and download options. The download option effects, that “Firmware Download” window is opened (see also below).

Whether the call of these functions was successful or not is indicated by the messages at the bottom of the assembler window.

- Firmware Download

This window allows the download of the user code and firmware data, including the configuration, to the non-volatile memory. In case the bootloader release code is set, the configuration from the FW Data 2 section is copied into the configuration registers.

“Firmware User Code” is either one of SciSense firmware examples, either the customers code or in case of chips with SciSense firmware (TDC-GP30-F01) the open source part. The FW Data 1 and 2 include firmware relevant coefficients and the configuration. The figure below shows an example for anTDC-GP30-F01 application. As free part of the user code firmware GP30Y_A1.D2.11.04.hex is loaded. For the configuration and flow calculation data file GP30Y_A1.A2.11.04.dat is loaded.

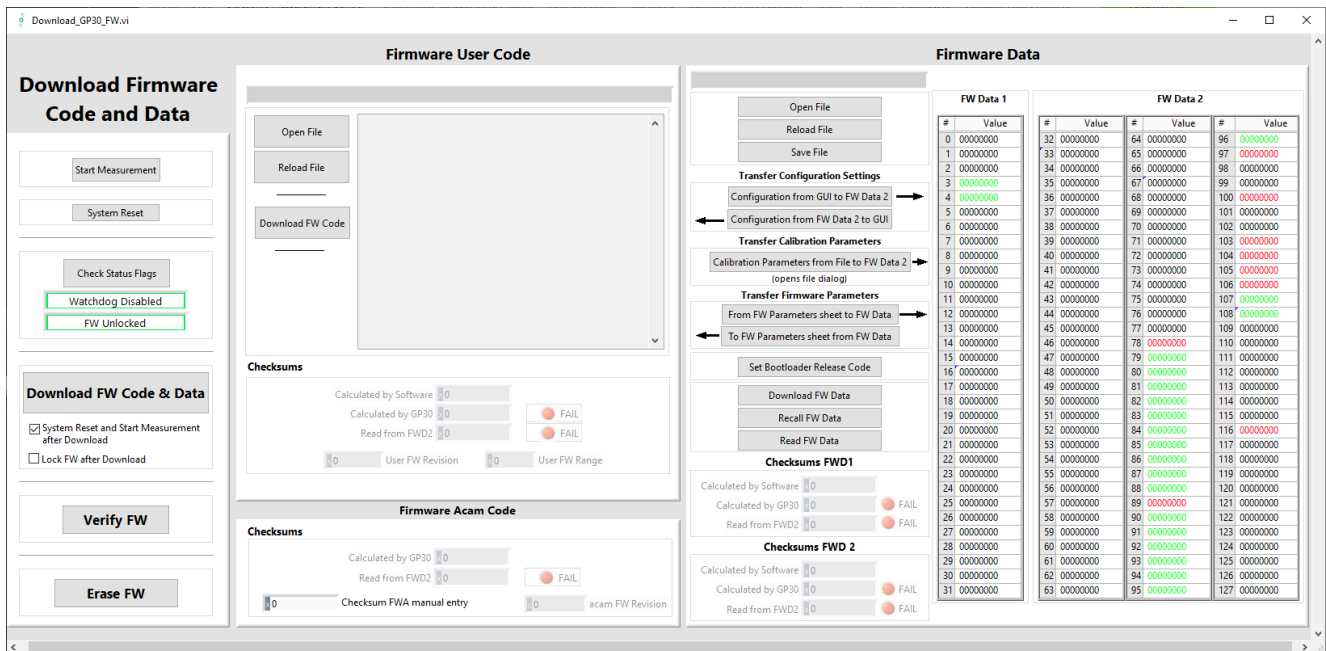

Figure 22: Firmware Download

- With “Check Status Flag”, the watchdog and the lock state of the GP30 can be checked. Please make sure that the watchdog is disabled before starting a download or other transactions in this window.
- In the “Firmware User Code” section, a firmware user code file (*.hex), which is typically generated by the assembler tool and intended for the user part of 4kx8 Program NVRAM, can be loaded by pressing “Open File”.
- In the “Firmware Data” section, a firmware data file (*.dat), which is intended for the 128x32 Data NVRAM, can be loaded by pressing “Open File”. This section also contains some additional transfer options from GUI to FW Data 2 fields and from GP30 back to FW Data 2 fields. The configuration can be exchanged between the GUI of the evaluation file and the data file. Calibration can also be exchanged between GUI and data file.
- By pressing “Download FW Code & Data” both files are stored in the corresponding NVRAMs. This action takes a few seconds. After the download, both files are located in the volatile as well in the non-volatile part of the appropriate NVRAMs. The download can be combined with a lock option of the firmware.
- When pressing “Download FW Code & Data” any running firmware program is stopped. If a new proper auto running firmware program is downloaded, this firmware can be started again by performing a system reset. A select box allows to reset and restart measurement automatically after download.
- The last four addresses of the FW Data 2 section contain the checksums which are stored to GP30 when downloading firmware to GP30. These fields are directly updated, when firmware files are loaded or content of firmware data fields are changed.
- Pressing the “Verify FW” button after downloading compares the content of the NVRAMs with the given files by their checksums. The software calculates the checksum of the given files and reads the calculated checksums of GP30 as well as the stored checksums at the end of FWD2 section. Note: The firmware data file word 127 is by default empty, not knowing the checksum of the on-chip SciSense firmware.

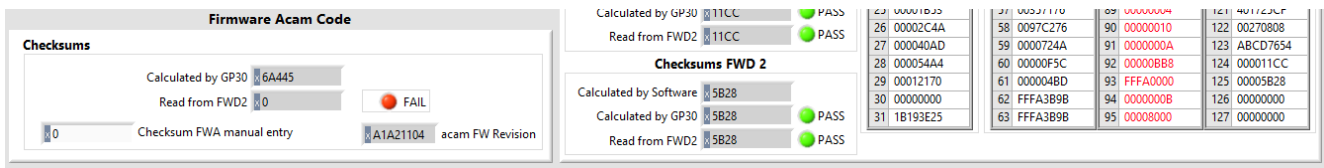

Figure 23: Firmware ScioSense Code

So copy manually the calculated checksum for the ScioSense code into the field “Checksum FW manual entry”. Word 127 in the data will be updated and after downloading again the verification will pass for all.

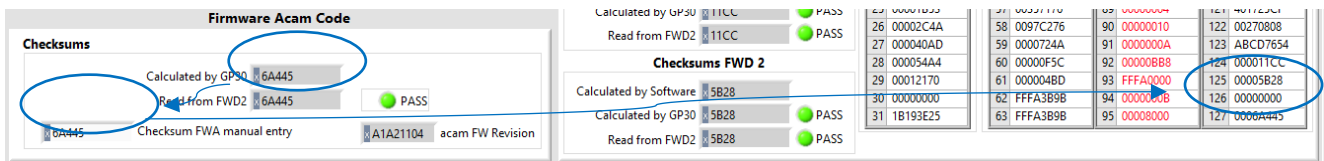

Figure 24: Verification by Calculated Checksum

- In the “Firmware Acam Code” section, the checksums for the ScioSense firmware code are also checked and displayed after a “Verify FW”. The ScioSense firmware code cannot be modified by user. Therefore a checksum calculated by software field is missing in this section.
- A lock state of GP30 or a hang-up, caused by a faulty firmware user code can be dissolved by pressing “Erase FW” button. After that, a new firmware (user code & data) need to be downloaded again.
- CPU Values

This tab is only for customer who uses the ScioSense firmware for flow calculation. It reads out some important CPU values like water temperature, flow, velocity, etc. To enable the readout the “Read calculated values” checkbox has to be set.

The lower sections allows to read from any RAM addresses.

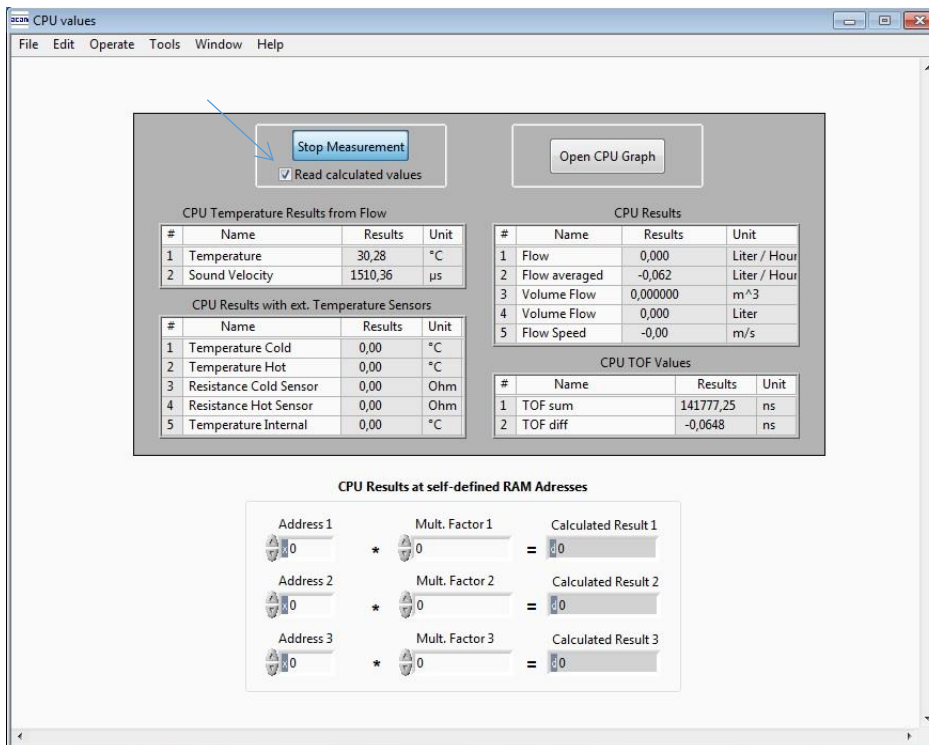

Figure 25: Flow Calculation Window (previous UI)

5.4 Help

When moving the cursor over the values in tabs of main window, the parameter name (used in the GP30 manual) is displayed. By right-click and selection of “Description and Tip”, a window is opened showing additional description of the value.

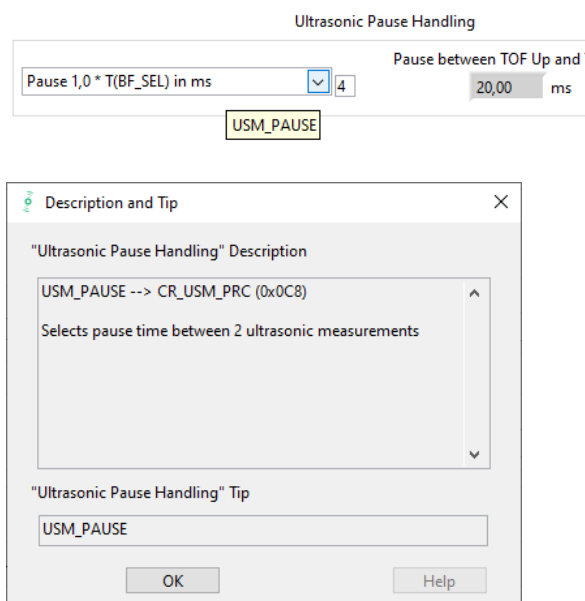

Figure 26: Description and Tip Window

- Help Contents
Not supported in this software revision.

- USB Communication

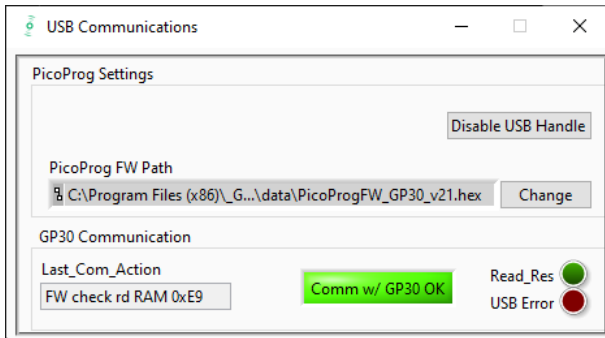

Figure 27: USB Communications

- About
Displays software version number together with general information about software and SciSense.

6 Schematics, Layers & BOM

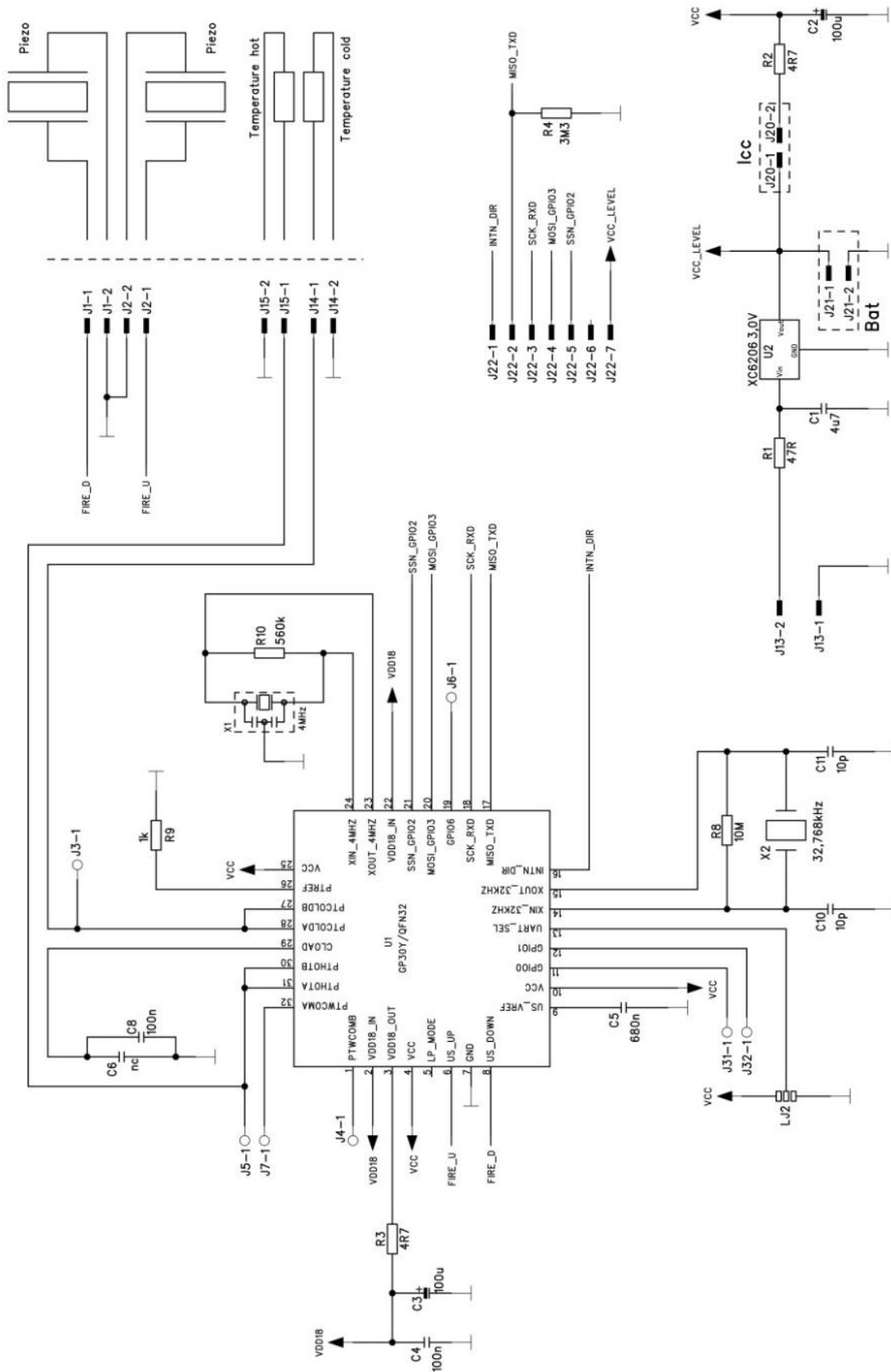

Figure 28: GP30-DEMO MODULE Schematics

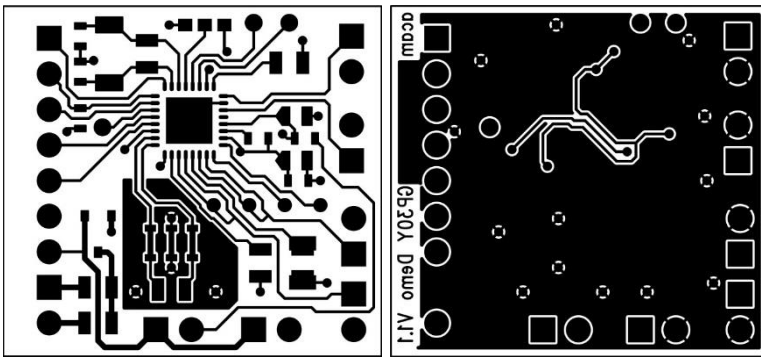

Figure 29: GP30-DEMO MODULE layout 2:1

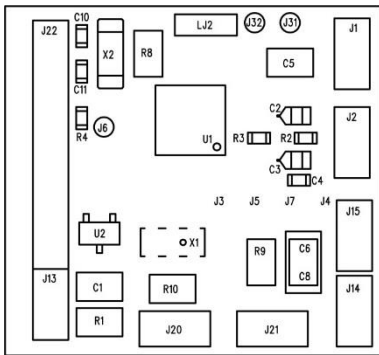

Figure 30: GP30-DEMO MODULE assembly 2:1

Table 2: Bill of materials for GP30-DEMO MODULE

Quantity	Designator	Value	Comment	Footprint
1	U1	TDC-GP30	TDC-GP30YD	QFN32
	U2	3.0 V	Voltage regulator	XC6206
1	X1	4 MHz	Ceramic resonator Murata	CSTR_G
1	X2	32.768 kHz	Quartz crystal Geyer	KX-327XS
1	C1	4.7 μ F	Chip capacitor	C805
2	C2,C3	100 μ F	Solid tantalum	F95_P
1	C4	100 nF	Chip capacitor	CC603
1	C5	680 nF	Chip capacitor	C805
1	C6	Nc	Chip capacitor	C805
1	C8	100 nF	Chip capacitor	C1206

2	C10, C11	10 pF	Chip capacitor	CC603
1	R1	47 Ω	Chip resistor	R805
2	R2, R3	4.7 Ω	Chip resistor	R603
1	R4	3.3 M Ω	Chip resistor	R603
1	R8	10 M Ω	Chip resistor	R805
1	R9	1 k Ω	Chip resistor	R805
1	R10	560 k Ω	Chip resistor	R805
1	J13	2.pol	Connector for power supply (combined with J22)	ST/254_2
1	J22	7.pol	Connector for SPI interface (combined with J13)	ST/254_7_1R
1	J20	2.pol	Jumper for current measurement of Vcc	ST/254_2
1	LJ2	3 pol.	Solder bridge to select between SPI & UART	QFN32

7 RoHS Compliance & ScioSense Green Statement

RoHS: The term RoHS compliant means that Sciosense B.V. products fully comply with current RoHS directives. Our semiconductor products do not contain any chemicals for all 6 substance categories, including the requirement that lead does not exceed 0.1% by weight in homogeneous materials. Where designed to be soldered at high temperatures, RoHS compliant products are suitable for use in specified lead-free processes.

ScioSense Green (RoHS compliant and no Sb/Br): ScioSense Green defines that in addition to RoHS compliance, our products are free of Bromine (Br) and Antimony (Sb) based flame retardants (Br or Sb do not exceed 0.1% by weight in homogeneous material).

Important Information: The information provided in this statement represents Sciosense B.V. knowledge and belief as of the date that it is provided. Sciosense B.V. bases its knowledge and belief on information provided by third parties, and makes no representation or warranty as to the accuracy of such information. Efforts are underway to better integrate information from third parties. Sciosense B.V. has taken and continues to take reasonable steps to provide representative and accurate information but may not have conducted destructive testing or chemical analysis on incoming materials and chemicals. Sciosense B.V. and Sciosense B.V. suppliers consider certain information to be proprietary, and thus CAS numbers and other limited information may not be available for release.

8 Copyrights & Disclaimer

Copyright Sciosense B.V High Tech Campus 10, 5656 AE Eindhoven, The Netherlands. Trademarks Registered. All rights reserved. The material herein may not be reproduced, adapted, merged, translated, stored, or used without the prior written consent of the copyright owner.

Devices sold by Sciosense B.V. are covered by the warranty and patent indemnification provisions appearing in its General Terms of Trade. Sciosense B.V. makes no warranty, express, statutory, implied, or by description regarding the information set forth herein. Sciosense B.V. reserves the right to change specifications and prices at any time and without notice. Therefore, prior to designing this product into a system, it is necessary to check with Sciosense B.V. for current information. This product is intended for use in commercial applications. Applications requiring extended temperature range, unusual environmental requirements, or high reliability applications, such as military, medical life-support or life-sustaining equipment are specifically not recommended without additional processing by Sciosense B.V. for each application. This product is provided by Sciosense B.V. "AS IS" and any express or implied warranties, including, but not limited to the implied warranties of merchantability and fitness for a particular purpose are disclaimed.

Sciosense B.V. shall not be liable to recipient or any third party for any damages, including but not limited to personal injury, property damage, loss of profits, loss of use, interruption of business or indirect, special, incidental or consequential damages, of any kind, in connection with or arising out of the furnishing, performance or use of the technical data herein. No obligation or liability to recipient or any third party shall arise or flow out of Sciosense B.V. rendering of technical or other services.

9 Revision information

Table 3: Revision history

Revision	Date	Comment	Page
4.0	2023 May 16	PICOPROG V3.0 replaced by PicoProg Lite UART is not supported	all

Note(s) and/or Footnote(s):

1. Page and figure numbers for the previous version may differ from page and figure numbers in the current revision.
2. Correction of typographical errors is not explicitly mentioned.