



## Product Description

GRF4005 is a broadband low noise gain block designed for small cell, wireless infrastructure and other high performance applications. With simple external matching, it exhibits outstanding broadband NF, linearity and return losses over wide fractional bandwidths with a single match.

Configured as a first stage LNA, linear driver or cascaded gain block, GRF4005 offers high levels of reuse both within a design and across platforms. The device is operated from a supply voltage ( $V_{DD}$ ) of 1.8 to 5.5 V.  $I_{DDQ}$  can be adjusted over a wide range for optimal efficiency and linearity.

Consult with the GRF applications engineering team for custom tuning/evaluation board data and device s-parameters.

## Features

Reference: 5V/170mA/2.5 GHz

- EVB NF: 0.88 dB
- Gain: 12.8 dB
- OP1dB: 27.5 dBm
- OIP3: 42.0 dBm
- Flexible Bias Voltage and Current
- Process: GaAs pHEMT

## Applications

- Linear Driver Amplifier
- Small Cells and Cellular Repeaters
- Distributed Antenna Systems
- First/Second Stage LNA

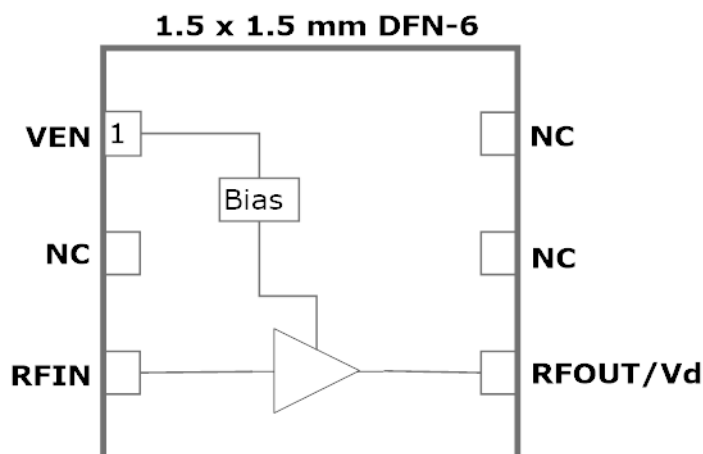



Released

# GRF4005

Broadband LNA/Linear Driver  
Tuning Range: 0.1–3.8 GHz

## Absolute Ratings:

Parameter	Symbol	Min.	Max.	Unit
Supply Voltage	V <sub>DD</sub>	0	6.0	V
RF Input Power: (Load VSWR < 2:1; V <sub>DD</sub> : 5.0 volts)	P <sub>IN MAX</sub>		22	dBm
Operating Temperature (Package Heat Sink)	T <sub>AMB</sub>	-40	105	°C
Maximum Channel Temperature (MTTF > 10 <sup>6</sup> Hours)	T <sub>MAX</sub>		170	°C
Maximum Dissipated Power	P <sub>DISS MAX</sub>		0.85	W
<b>Electrostatic Discharge:</b>				
Charged Device Model:	CDM	1500		V
Human Body Model:	HBM	500		V
<b>Storage:</b>				
Storage Temperature	T <sub>STG</sub>	-65	150	°C
Moisture Sensitivity Level	MSL		1	--



Caution! ESD Sensitive Device



Exceeding Absolute Maximum Rating conditions may cause permanent damage to the device.

**Note: For manufacturing information, see the [Guerrilla-RF.com](http://Guerrilla-RF.com) website for the following document located on the GRF4005 landing page: Manufacturing Note—MN-001 Product Tape and Reel, Solderability and Package Outline Specification:**

[Link to manufacturing note](#)

## Pin Out (Top View)



## Pin Assignments:

Pin	Name	Description	Note
1	V <sub>ENABLE</sub>	Enable Voltage Input	V <sub>ENABLE</sub> and series resistor set I <sub>DDQ</sub> . V <sub>ENABLE</sub> < =0.2 volts disables device. On -die pull-down resistor will turn the part off if this node is allowed to float.
2	NC	No Connect or Ground	No internal connection to die
3	RF_In	LNA RF input	An external DC blocking cap must be used.
4	RF_Out	LNA RF output	V <sub>DD</sub> must be applied through a choke to this pin
5	NC	No Connect or Ground	No internal connection to die
6	NC	No Connect or Ground	No internal connection to die
PKG BASE	GND	Ground	Provides DC and RF ground for LNA, as well as thermal heat sink. Recommend multiple 8 mil vias beneath the package for optimal RF and thermal performance. Refer to evaluation board top layer graphic on schematic page.



Released

# GRF4005

Broadband LNA/Linear Driver  
Tuning Range: 0.1–3.8 GHz

## Nominal Operating Parameters:

Parameter	Symbol	Specification			Unit	Condition
		Min.	Typ.	Max.		
Test Frequency	F <sub>TEST</sub>		2500		MHz	V <sub>DD</sub> = 5.0 V, T <sub>A</sub> = 25 °C
Gain	S <sub>21</sub>	11.8	12.8		dB	
Evaluation Board Noise Figure	NF		0.88	1.05	dB	Includes Board Losses
Output 3rd Order Intercept	OIP <sub>3</sub>		42.0		dBm	+2.0 dBm P <sub>OUT</sub> per tone at 2 MHz Spacing (2499 and 2501 MHz)
Output 1dB Compression Power	OP <sub>1dB</sub>	26.0	27.5		dBm	
Switching Rise Time	T <sub>RISE</sub>		500		ns	
Switching Fall Time	T <sub>FALL</sub>		500		ns	
Supply Current	I <sub>DD</sub>	145	170	195	mA	Target I <sub>DDQ</sub> : 170 mA
Leakage Current	I <sub>LEAKAGE</sub>		4.5	20	uA	V <sub>DD</sub> : 5.0V; V <sub>ENABLE</sub> : 0.0V
Thermal Data						
Thermal Resistance: (Infra-Red Scan)	Θ <sub>jc</sub>		87		°C/W	On standard Evaluation Board
Channel Temperature @ +85 C Reference (Package heat sink)	T <sub>CHANNEL</sub>		160 (See note)		°C	V <sub>DD</sub> : 5.0 V; I <sub>DDQ</sub> : 170 mA; No RF; P <sub>DISS</sub> : 850 mW

Note: MTTF >10<sup>6</sup> hours for T<sub>CHANNEL</sub> < =170 degrees C.



Released

# GRF4005

Broadband LNA/Linear Driver  
Tuning Range: 0.1–3.8 GHz

## GRF4005 Evaluation Board Measured Data (1.7 to 2.7 GHz Tune):

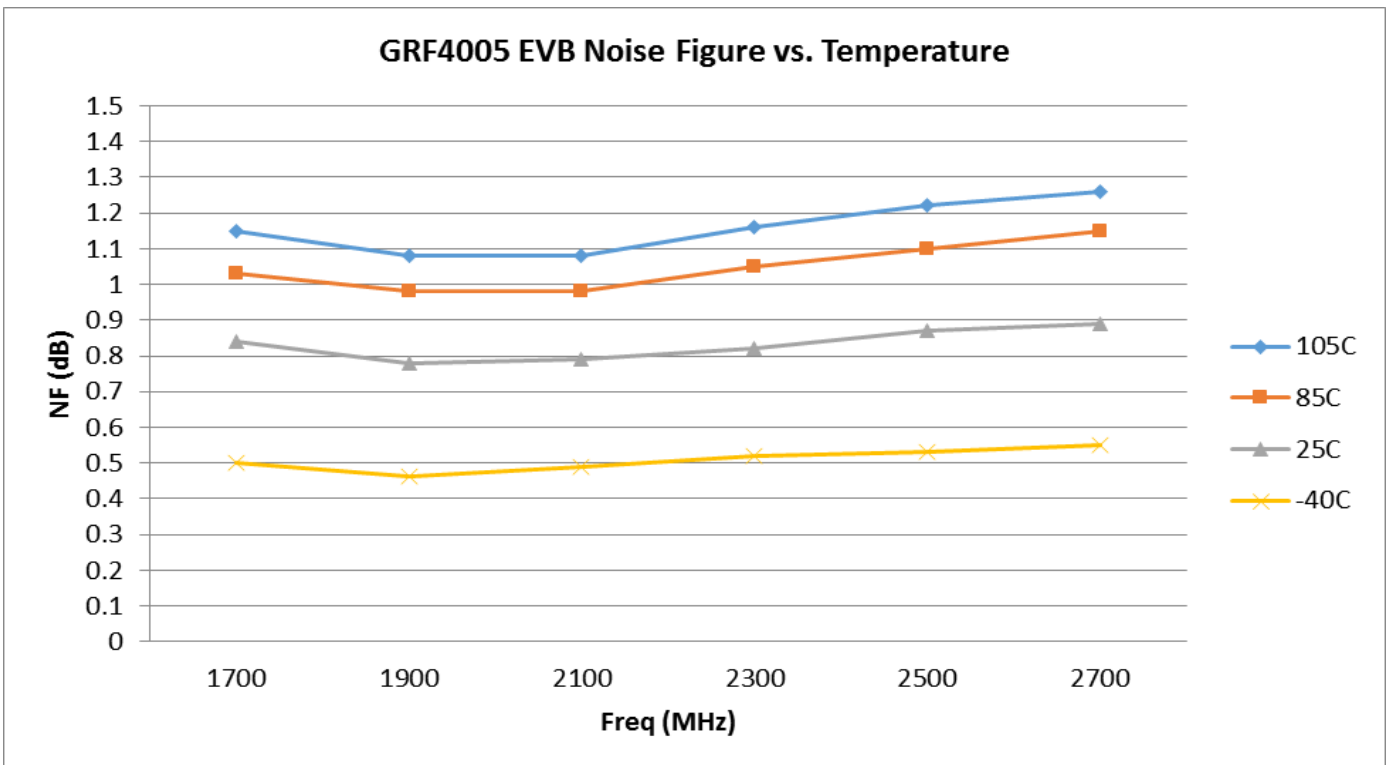
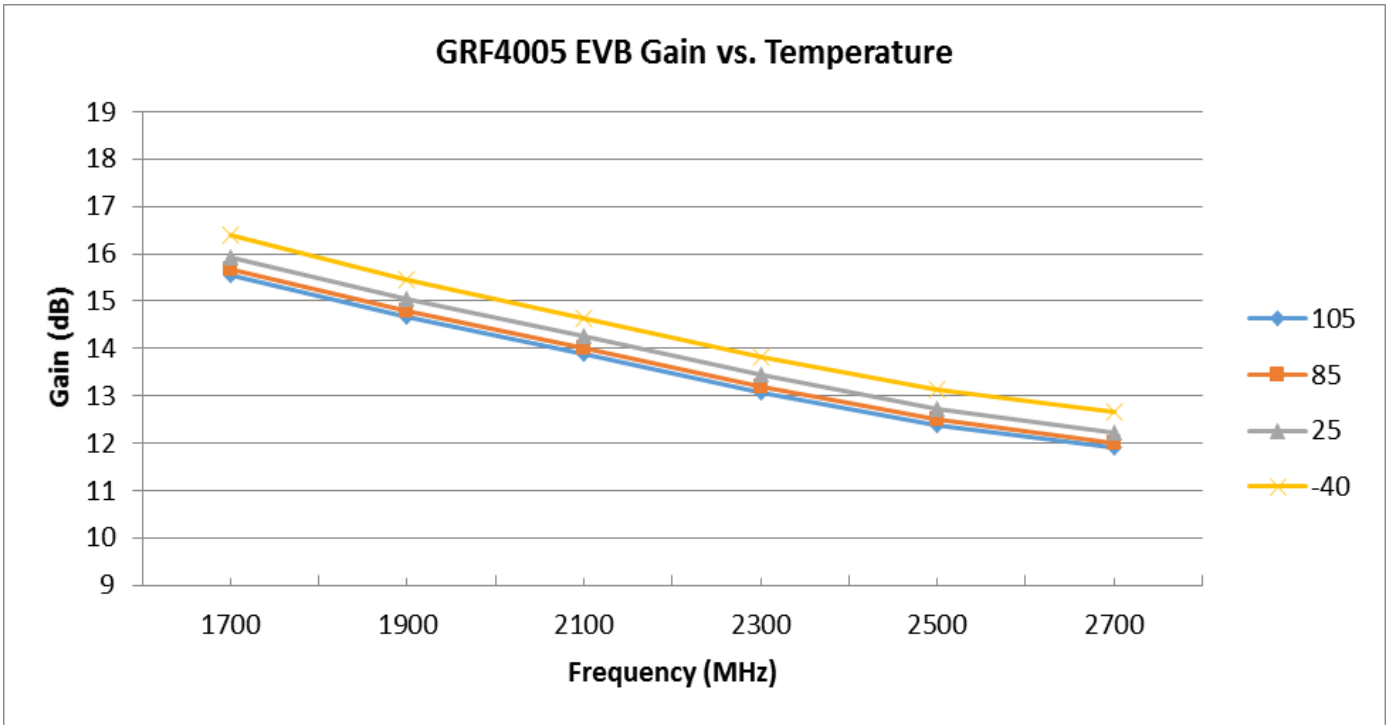



Released

# GRF4005

Broadband LNA/Linear Driver  
Tuning Range: 0.1–3.8 GHz

## GRF4005 Evaluation Board Measured Data (1.7 to 2.7 GHz Tune):

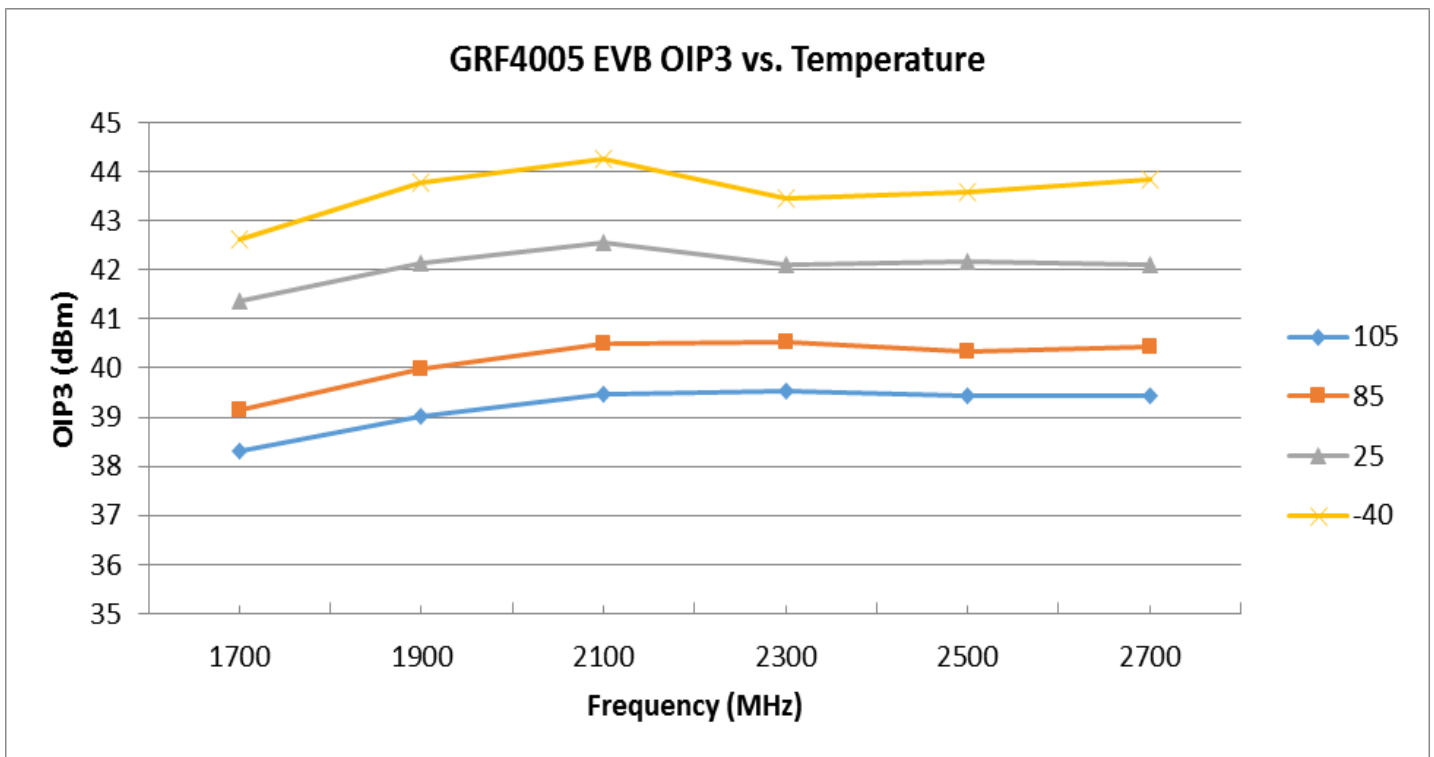
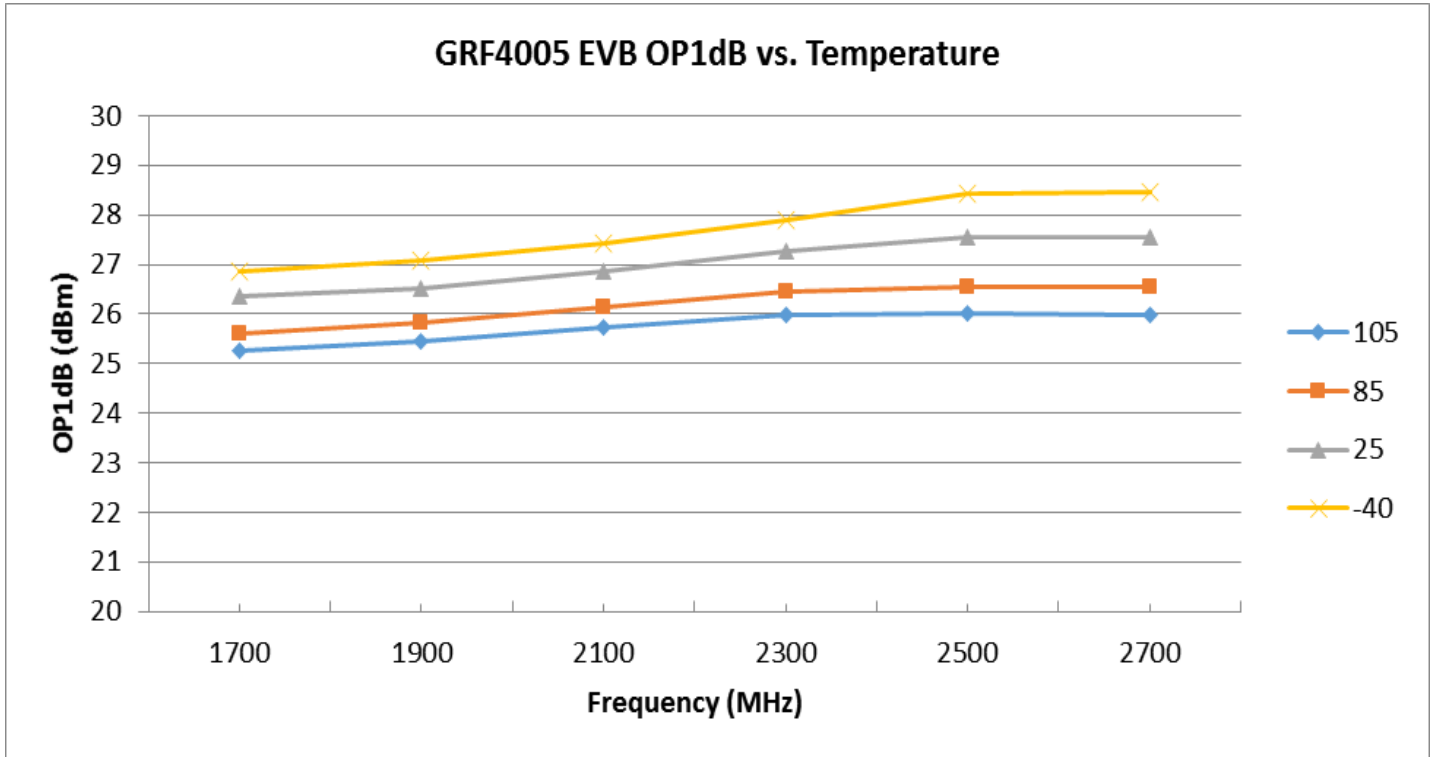



Released

# GRF4005

Broadband LNA/Linear Driver  
Tuning Range: 0.1–3.8 GHz

## GRF4005 Evaluation Board S-Pars and Stability Mu Factor: (1.7 – 2.7 GHz Tune)

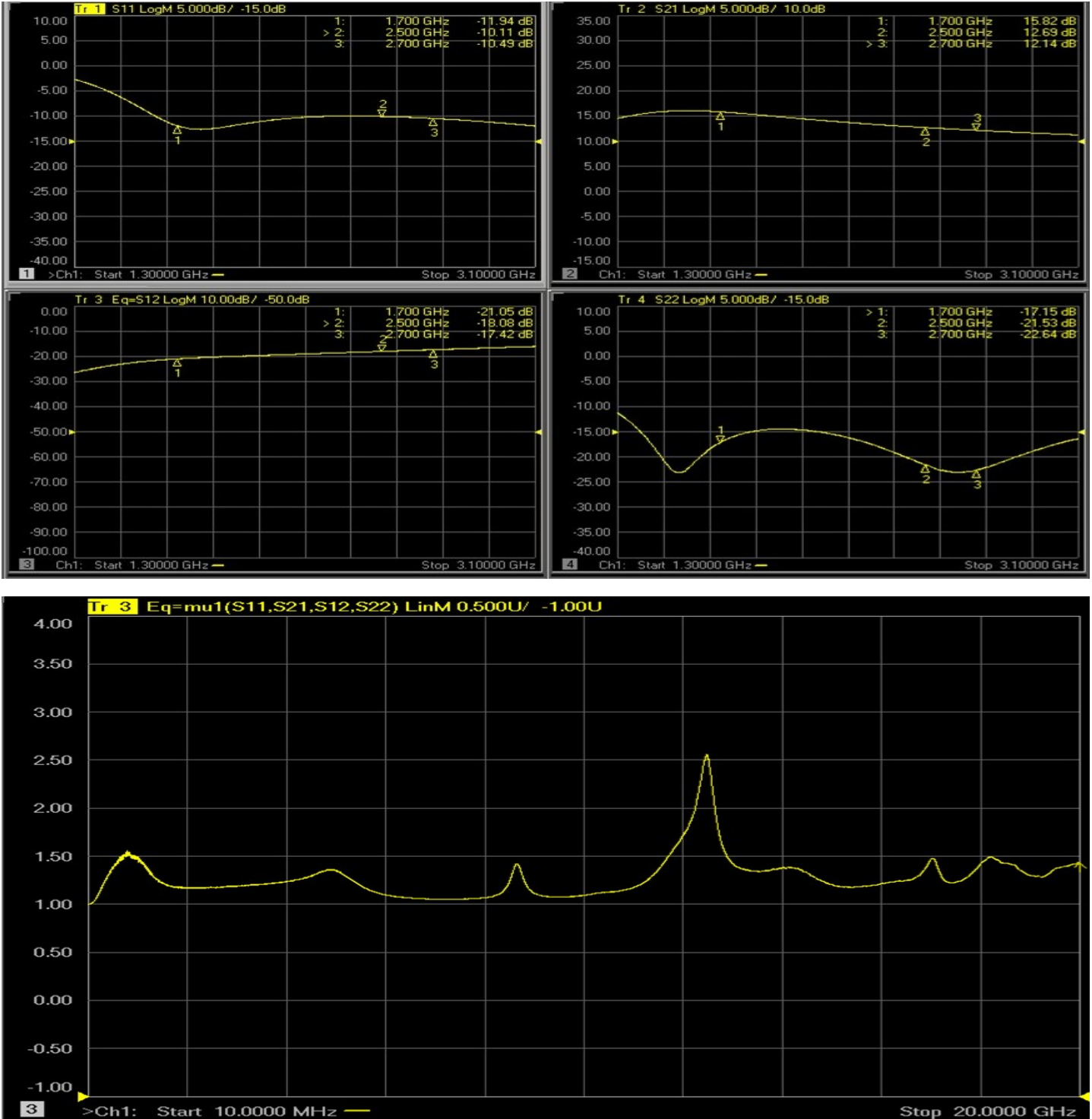

Note: Mu factor  $\geq 1.0$  implies unconditional stability.

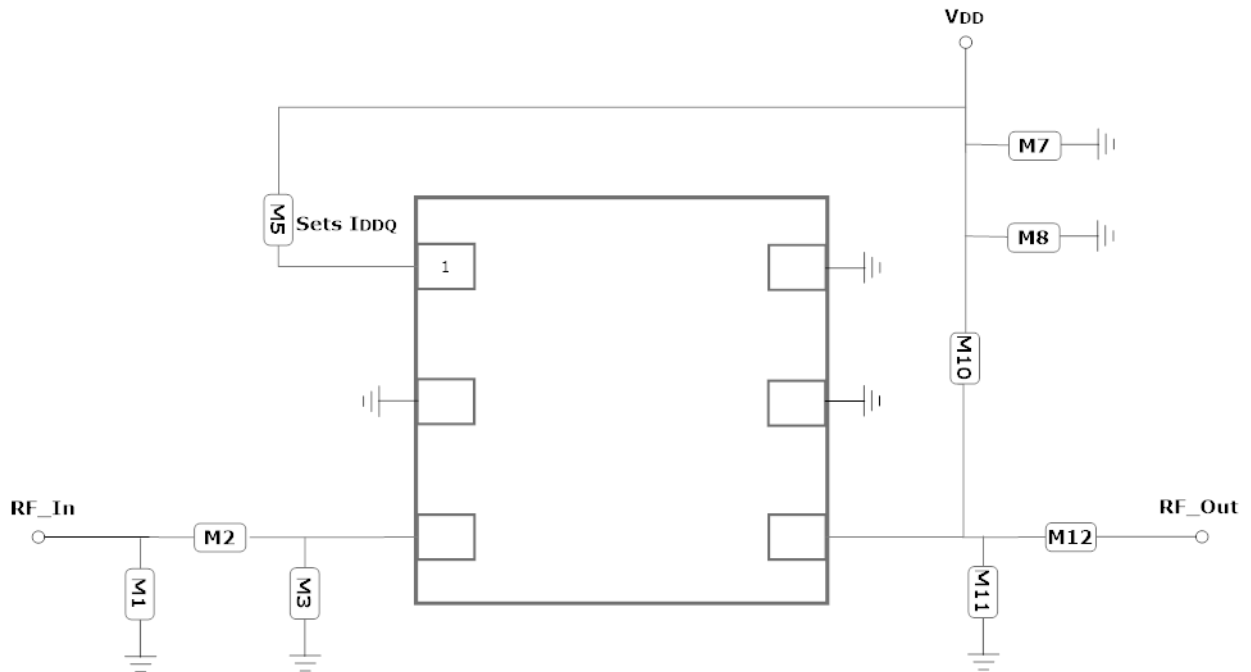

GRF4005 Application Schematic

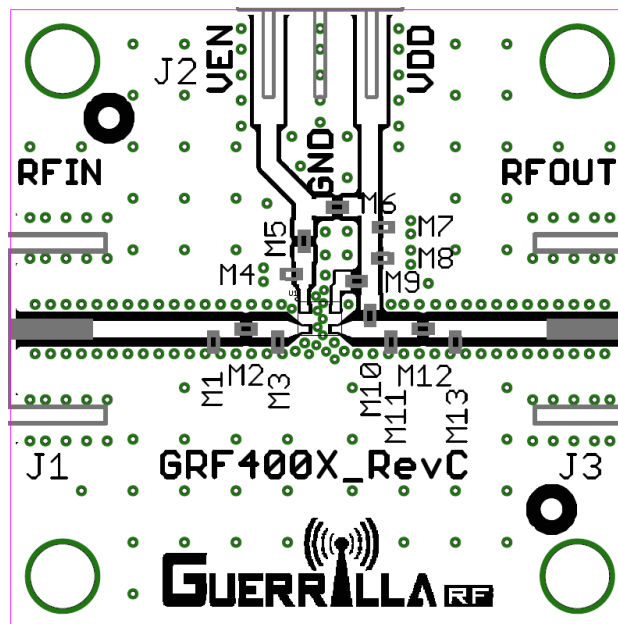

GRF400X Evaluation Board Assembly Diagram





Released

# GRF4005

Broadband LNA/Linear Driver  
Tuning Range: 0.1–3.8 GHz

## GRF4005 Standard Evaluation Board BOM: (1.7 to 2.7 GHz Tune)

Component	Type	Manufacturer	Family	Value	Package Size	Substitution
M1	Inductor	Coilcraft	HPA	3.3 nH	0402	ok
M2	Capacitor	Murata	GJM	2.0 pF	0402	ok
M3	Capacitor	Murata	GJM	1.5 pF	0402	ok
M5 (See curves)	Resistor: 5%	Various	—	—	0402	ok
M7	Capacitor	Murata	GRM	0.1 uF	0402	ok
M8	Capacitor	Murata	GRM	27 pF	0402	ok
M10	Inductor	Coilcraft	HPA	18.0 nH	0402	ok
M11	Capacitor	Murata	GJM	1.0 pF	0402	ok
M12	Capacitor	Murata	GJM	15 pF	0402	ok
Evaluation Board:	GRF400X_RevC					

GRF4005 M5 Resistor Value Lookup Chart (Vdd: 5.0 volts)

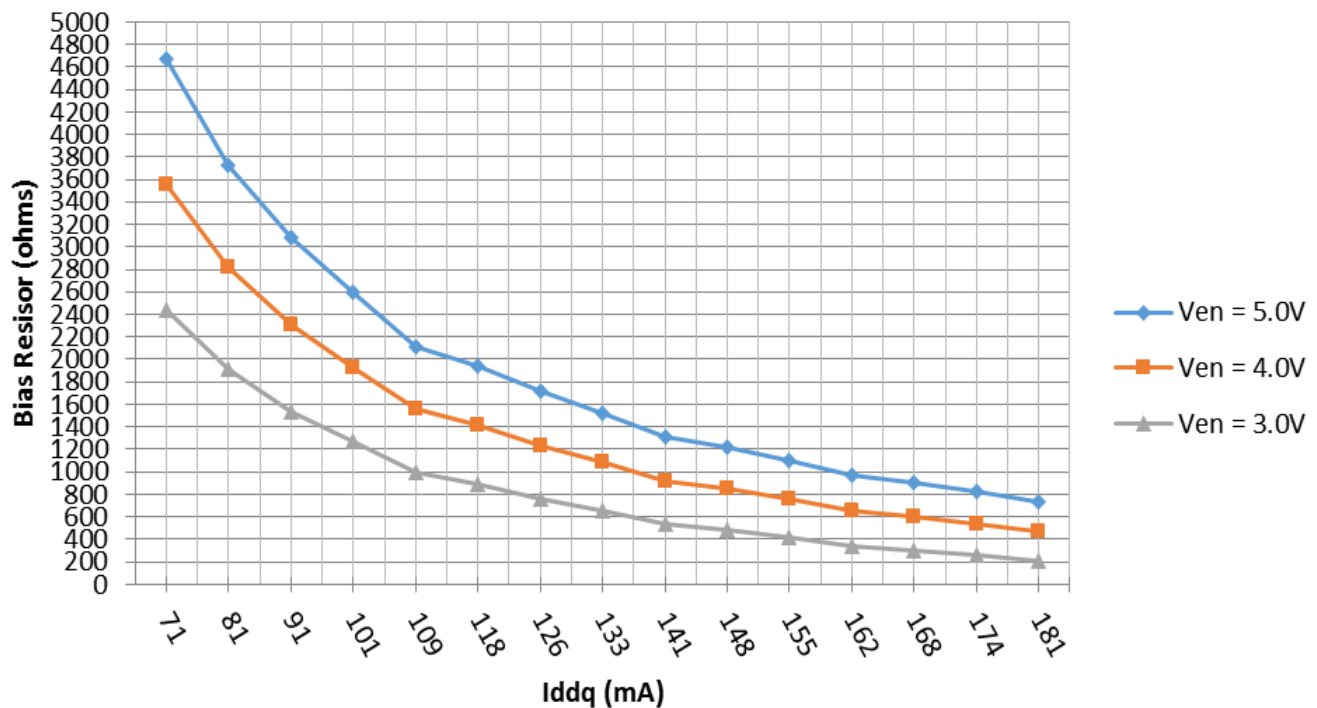

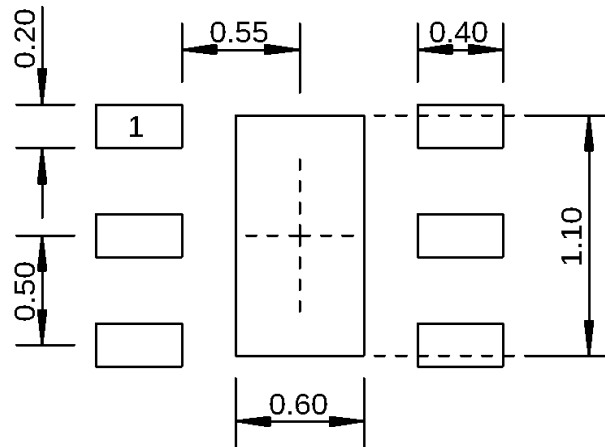

Dimensions in millimeters

### 1.5 mm DFN-6 Suggested PCB Footprint (Top View)

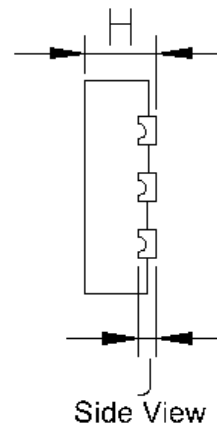
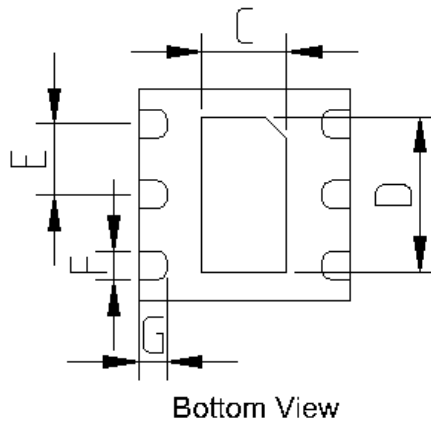
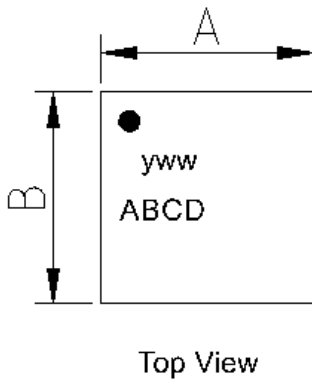

Dimensions (MM)	
A	1.5 +/- 0.050
B	1.5 +/- 0.050
C	.6 +/- 0.050
D	1.1 +/- 0.050
E	.5 Bsc
F	.2 +/- 0.050
G	.2 +/- 0.050
H	.45 +/- 0.050
J	.12 Ref.

### 1.5 mm DFN-6 Package Dimensions

### Tape and Reel Information:

Guerrilla RF’s Tape and Reel specification complies with the Electronics Industries Association (EIA) standards for ‘Embossed Carrier Tape of Surface Mount Components for Automatic Handling’. Reference EIA-481. See the table on the following page for Tape and Reel specifications along with units per reel.

Devices are loaded with pins down into the carrier pocket with protective cover tape, wound into a plastic reel. Each reel will be packaged in a cardboard box. There will be product labels on the reel, the protective ESD bag and the outside surface of the box.

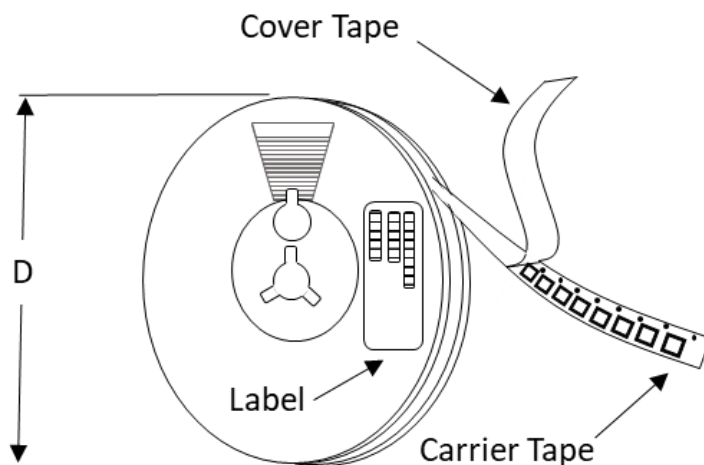

Tape and Reel Packaging with Reel Diameter Noted (D)

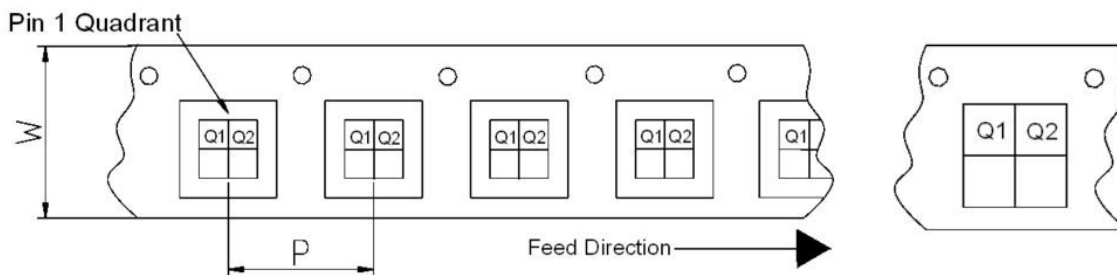

Carrier Tape Width (W), Pitch (P), Feed Direction and Pin 1 Quadrant Information



Released

# GRF4005

Broadband LNA/Linear Driver  
Tuning Range: 0.1–3.8 GHz

Tape and Reel Specification and Device Package Information Table

Package				Carrier Tape			Reel	
Type	Dimensions (mm)	Leads	Weight (mg)	Width (W) (mm)	Pocket Pitch (P) (mm)	Pin 1 Quadrant	Diameter (D) (inches)	Units per Reel
QFN	2.0 x 2.0 x 0.50	12	7	8	4	Q1	7	2500
QFN	3.0 x 3.0 x 0.85	16	24	12	8	Q1	7	1500
DFN	1.5 x 1.5 x 0.45	6	4	8	4	Q1	7	2500
DFN	2.0 x 2.0 x 0.75	8	12	8	4	Q1	7	2500
LFM	3.5 x 3.5 x 0.75	See note	TBD	12	8	Q2	7	1500
LFM	4.0 x 4.0 x 0.75	See note	TBD	12	8	Q2	7	1500

Note: Lead count may vary. Reference applicable product data sheet