



Product Description

GRF4042 is a low noise amplifier (LNA) with low loss bypass designed for high performance applications up to 2.7 GHz. Guerrilla Armor™ technology provides exceptional off-state isolation in the presence of high RF input signal levels in LNA disabled mode.

With integrated matching, the device achieves outstanding noise figure (NF), high gain and high linearity over 400-2700 MHz using as few as three external components. The data sheet also provides narrow band matches covering 700-960 MHz and 1710-2170 MHz for applications needing enhanced return loss.

The LNA is operated from a single positive supply of 1.8 to 5.0 V with a selectable IDDQ range of 15 to 90 mA.

Consult with the GRF applications engineering team for custom tuning/evaluation board data and device s-parameters.

Features

Reference: 5V/70mA/1.9 GHz

- Bypass + Guerrilla Armor™
- EVB NF: 1.0 dB
- Gain: 16.0 dB
- Bypass Gain: -1.5 dB
- OIP3: 36.3 dBm
- OP1dB: 22.0 dBm
- High Off-State Isolation: >30 dB
- Flexible Bias Voltage and Current
- Internally Matched to 50 Ω
- Process: GaAs pHEMT

Applications

- Cellular Repeaters and Signal Boosters
- Cellular Infrastructure
- WLAN, ZigBee®/Bluetooth®
- First Stage LNA
- General Purpose Bypass Amplifier

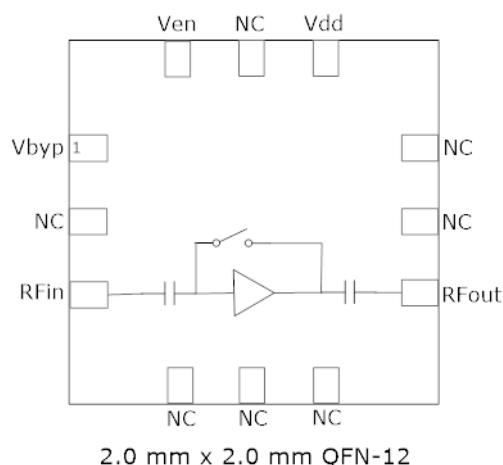



Released

GRF4042

LNA w/Bypass & Guerrilla

Armor™: 0.4 to 2.7 GHz

Absolute Ratings:

Parameter	Symbol	Min.	Max.	Unit
Supply Voltage	V _{DD}	0	6.0	V
RF Input Power CW: (Load VSWR < 2:1; V _D : 5.0 volts)	P _{IN MAX}		20	dBm
Operating Temperature (Package Heat Sink)	T _{AMB}	-40	105	°C
Maximum Channel Temperature (MTTF > 10 ⁶ Hours)	T _{MAX}		170	°C
Maximum Dissipated Power	P _{DISS MAX}		500	mW
Electrostatic Discharge:				
Charged Device Model:	CDM	1500		V
Human Body Model:	HBM	250		V
Storage:				
Storage Temperature	T _{STG}	-65	150	°C
Moisture Sensitivity Level	MSL		1	--



Caution! ESD Sensitive Device



Exceeding Absolute Maximum Rating conditions may cause permanent damage to the device.

Note: For manufacturing information, see the Guerrilla-RF.com website for the following document located on the GRF4042 landing page: Manufacturing Note—MN-001 Product Tape and Reel, Solderability and Package Outline Specification.

[Link to manufacturing note:](#)

Pin Out (Top View)

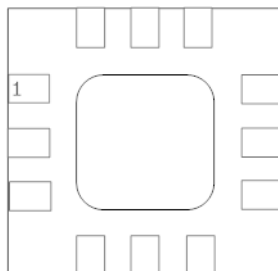

Pin Assignments:

Pin	Name	Description	Note
1	V _{BYPASS}	Low Insertion Loss Bypass	See control logic truth table
2	NC	No Connect or Ground	No internal connection to die
3	RF_In	RF Input	Internally DC blocked. Note: Do not apply DC voltage > 0.5 volts.
4	NC	No Connect or Ground	No internal connection to die
5	NC	No Connect or Ground	No internal connection to die
6	NC	No Connect or Ground	No internal connection to die
7	RF_Out	RF Output	Internally DC blocked. Note: Do not apply DC voltage > 0.5 volts.
8	NC	No Connect or Ground	No internal connection to die
9	NC	No Connect or Ground	No internal connection to die
10	V _{DD}	Supply Voltage Input	Provide device V _{dd} via external bias inductor
11	NC	No Connect or Ground	No internal connection to die
12	V _{ENABLE}	Enable Voltage Input	See control logic truth table. External resistor in series to set I _{ddq}
PKG BASE	Gnd	Ground	Provides DC and RF ground for LNA, as well as thermal heat sink. Recommend multiple 8 mil vias beneath the package for optimal RF and thermal performance. Refer to evaluation board top layer graphic on schematic page.

Control Logic Truth Table:

Mode	Description	V _{dd}	V _{ENABLE}	V _{BYPASS}
High Gain	High LNA Gain	>= 1.8	1	0
Bypass	High Linearity Bypass	>= 1.8	0	1
Disabled Mode (Guerrilla Armor™)	LNA Powered Down	>= 1.8	0	0
Logic Level "0"	Logic Low	>= 1.8	0.0V to 0.2V	0.0V to 0.2V
Logic Level "1"	Logic High	>= 1.8	1.5V to V _{DD}	1.5V to V _{DD}



Released

GRF4042

LNA w/Bypass & Guerrilla

Armor™: 0.4 to 2.7 GHz

Nominal Operating Parameters:

Parameter	Symbol	Specification			Unit	Condition
		Min.	Typ.	Max.		
High Gain Mode						V _{DD} = 4.3 V; Temp: +25C
Test Frequency	F _{TEST}		1900		MHz	
Gain	S ₂₁	15.0	16.0		dB	
Noise Figure (De-embedded)	NF		0.9	1.1	dB	
Output 1dB Compression Point	OP1dB	18.5	19.5		dBm	
Output Third Order Intercept Point	OIP3		30.0		dBm	
Supply Current	I _{DD}		40		mA	
Enable Current	I _{ENABLE}		1.5		mA	
Bypass Mode						V _{DD} : 4.3 V; V _{ENABLE} : LOW; V _{BYPASS} : High
Gain	S(2,1)	-2.5	-1.5		dB	
Output 1dB Compression Point	OP1dB	15.0	19.0		dBm	
Output Third Order Intercept Point	OIP3		45.0		dBm	
Disabled Mode (Guerrilla Armor™)						V _{DD} = 4.3 V, V _{ENABLE} : LOW; V _{BYPASS} : LOW
Gain	S(2,1)		-35.0		dB	
Leakage Current	I _{LEAKAGE}		600	1000	uA	V _{DD} = 4.3 V; V _{ENABLE} : 0.0 V; V _{BYPASS} : 0.0V
Thermal Data						
Thermal Resistance (Infra-Red Scan)	Θ _{Jc}		132		°C/W	
Channel Temperature @ +85 C reference (Package heat sink)	T _{CHANNEL}		108 (See note)		°C	V _{DD} : 4.3 V; I _{DDQ} : 40 mA; No RF; Dissipated Power: 172 mW

Note: MTTF >10⁶ hours for T_{CHANNEL} <=170 degrees C.

GRF4042 Evaluation Board Performance Summary Table (Standard Broadband Match):

Tune (MHz)	Reference Freq. (MHz)	Gain (dB)	Eval Board NF (dB)	OP1dB (dBm)	OIP3 (dBm)	Bias Condition (V/mA)
700–2700	700	21.7	1.20	21.6	35.3	5.0/70
700–2700	1700	16.4	0.89	22.4	36.4	5.0/70
700–2700	1950	15.3	0.98	22.0	36.3	5.0/70
700–2700	2700	12.8	1.10	21.4	36.1	5.0/70



Released

GRF4042

LNA w/Bypass & Guerrilla

Armor™: 0.4 to 2.7 GHz

Band-Specific Data with Low/High Band Tunes (Gain Mode; Bias: 4.3V/40 mA)

Freq. (MHz)	Gain (dB)	NF (dB)	IP1dB (dBm)	OP1dB (dBm)	IIP3 (dBm)	OIP3 (dBm)	Tuning
707	19.8	1.2	-0.5	19.8	7.3	28.7	700 - 960 MHz
737	20.0	1.1	-0.3	20.0	7.6	28.9	700 - 960 MHz
751	20.1	1.1	-0.2	20.1	7.8	29.0	700 - 960 MHz
782	19.9	1.0	0.0	19.9	7.7	28.6	700 - 960 MHz
836	20.3	0.95	0.4	20.3	8.2	29.2	700 - 960 MHz
881	20.2	0.90	0.8	20.2	8.5	28.9	700 - 960 MHz
1732	16.7	1.1	5.1	20.8	13.1	29.8	1710 - 2170 MHz
1880	16.0	1.1	5.2	20.3	13.4	29.4	1710 - 2170 MHz
1960	15.5	1.0	6.0	20.6	14.5	30.0	1710 - 2170 MHz
2132	15.0	1.0	6.6	20.6	15.4	30.3	1710 - 2170 MHz

Band-Specific Data with Low/High Band Tunes (Bypass Mode; VDD: 4.3V)

Freq. (MHz)	Gain (dB)	NF (dB)	IP1dB (dBm)	OP1dB (dBm)	IIP3 (dBm)	OIP3 (dBm)	Tuning
707	-1.5	1.5	25.8	23.3	48.1	46.6	700 - 960 MHz
737	-1.2	1.2	25.8	23.6	47.9	46.7	700 - 960 MHz
751	-1.1	1.1	25.8	23.7	47.5	46.4	700 - 960 MHz
782	-1.2	1.2	25.7	23.5	48.0	46.8	700 - 960 MHz
836	-1.1	1.1	25.6	23.5	48.0	46.9	700 - 960 MHz
881	-1.1	1.1	25.8	23.7	47.9	46.8	700 - 960 MHz
1732	-1.5	1.5	24.2	21.7	47.5	46.0	1710 - 2170 MHz
1880	-1.3	1.3	23.8	21.5	47.0	45.7	1710 - 2170 MHz
1960	-1.2	1.2	23.4	21.2	47.4	46.2	1710 - 2170 MHz
2132	-1.3	1.3	23.1	20.8	47.5	46.2	1710 - 2170 MHz



Released

GRF4042

LNA w/Bypass & Guerrilla

Armor™: 0.4 to 2.7 GHz

GRF4042 Evaluation Board Performance (Standard Broadband Match):

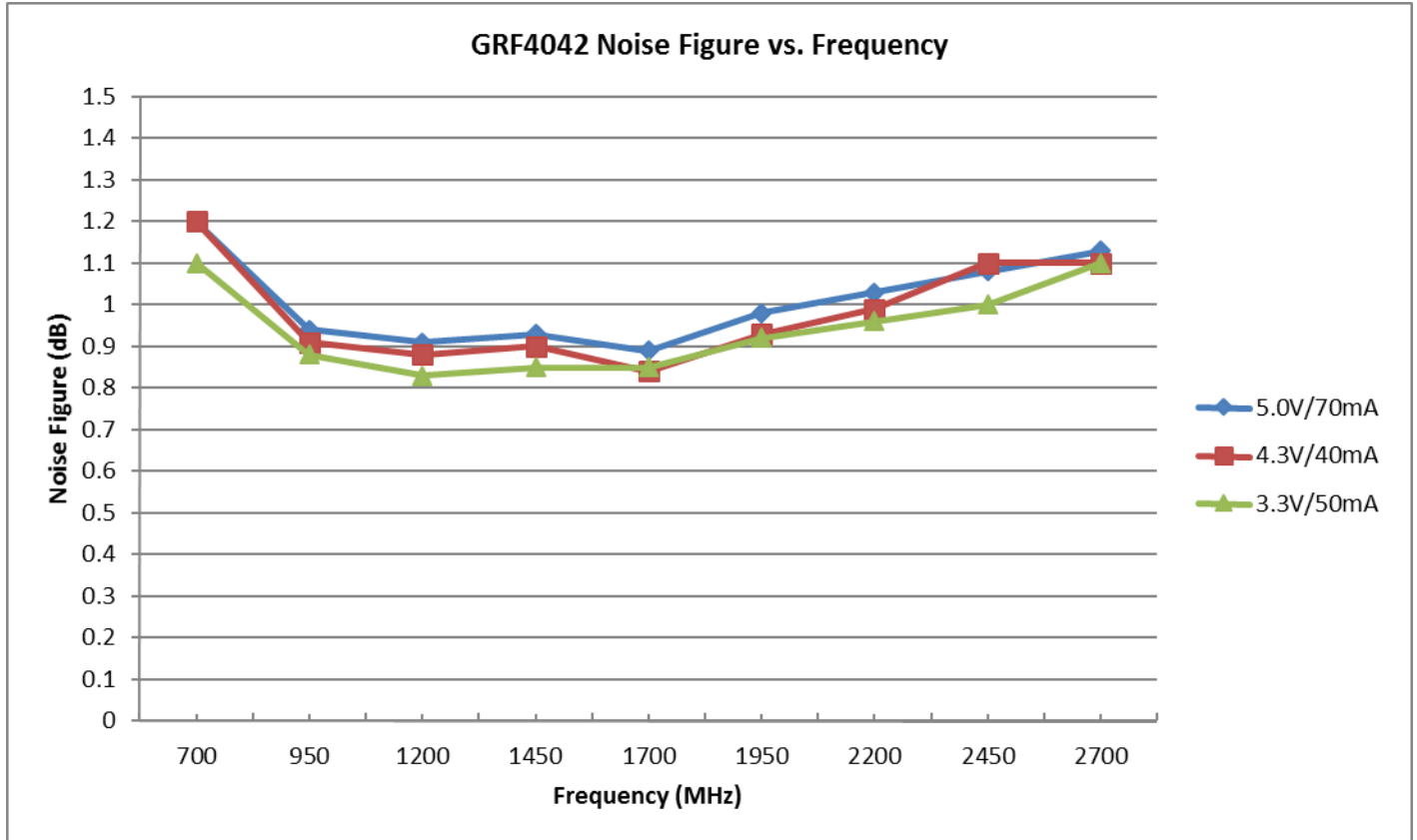



Released

GRF4042

LNA w/Bypass & Guerrilla

Armor™: 0.4 to 2.7 GHz

GRF4042 Evaluation Board Performance (Standard Broadband Match):

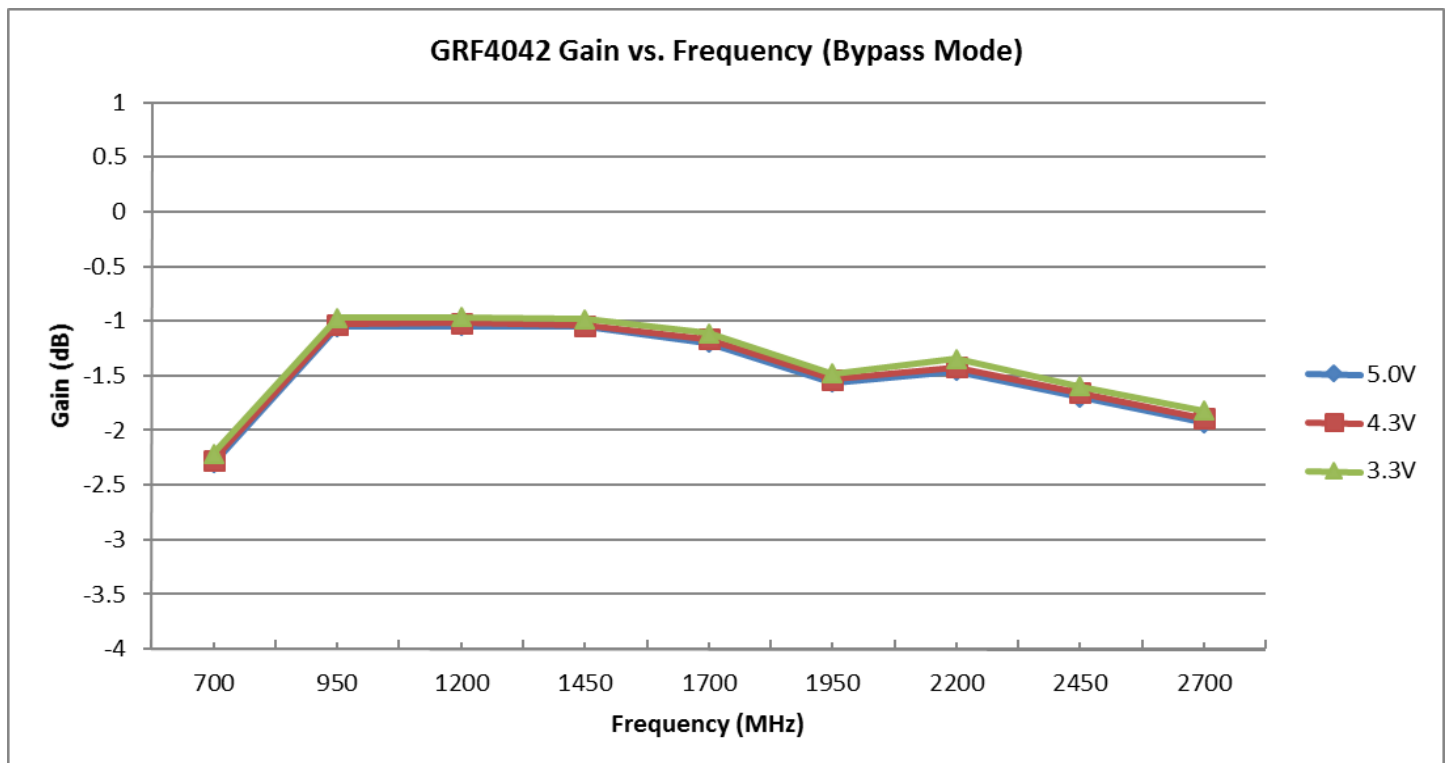
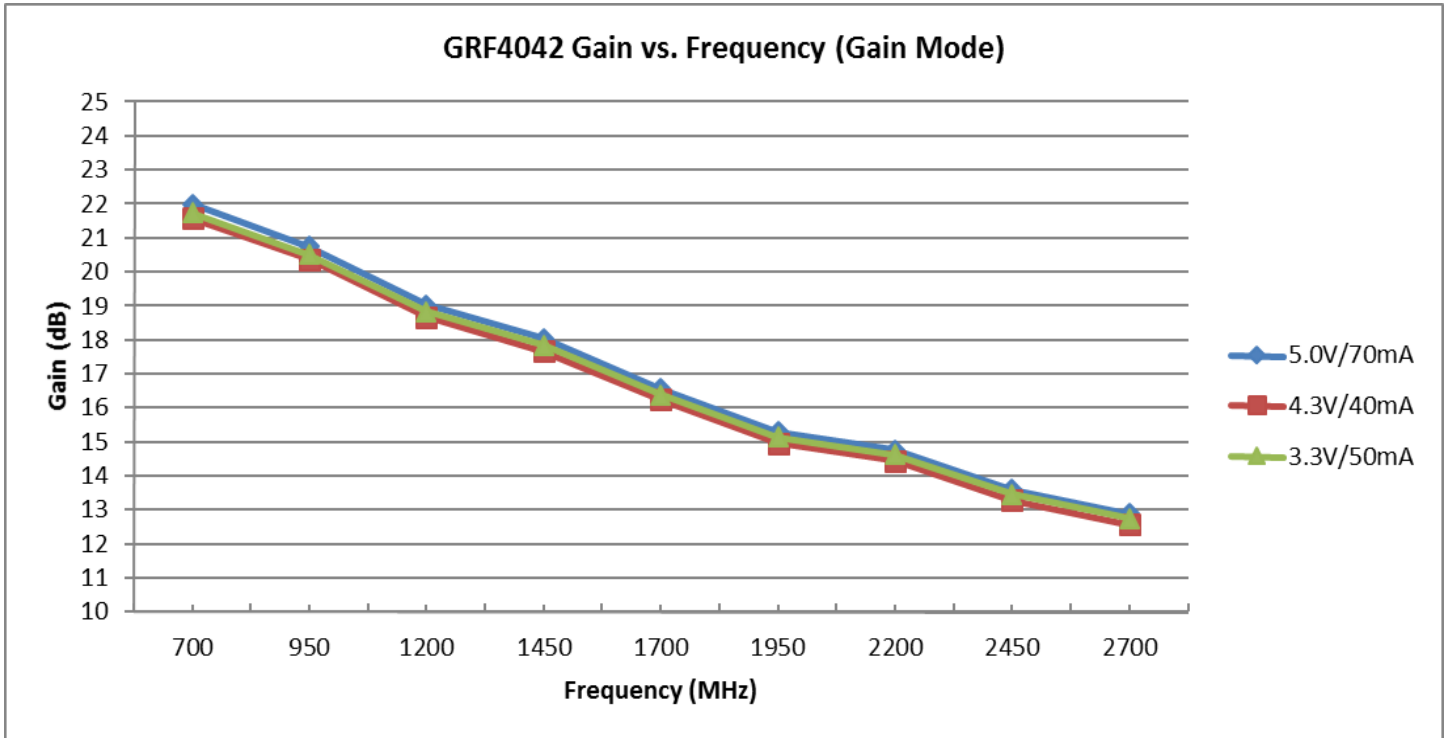



Released

GRF4042

LNA w/Bypass & Guerrilla

Armor™: 0.4 to 2.7 GHz

GRF4042 Evaluation Board Performance (Standard Broadband Match):

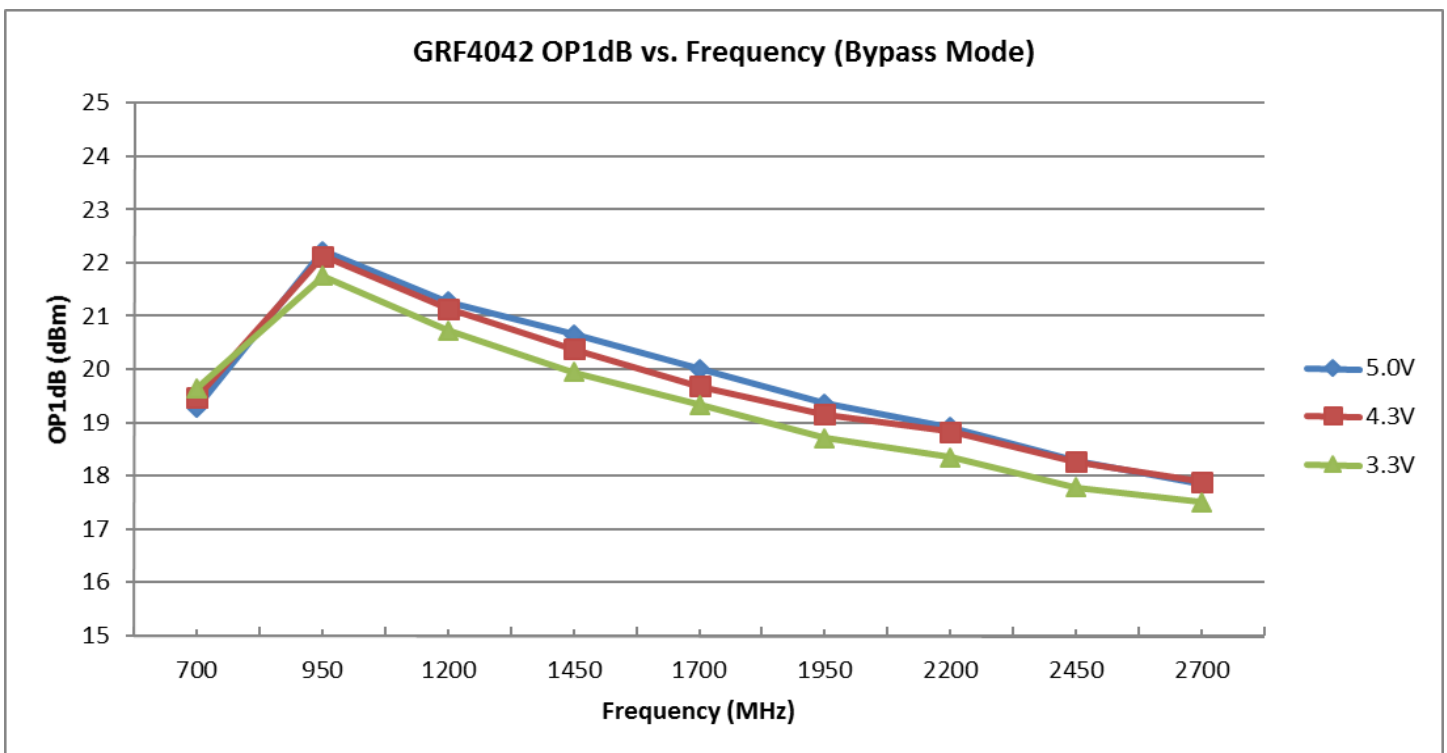
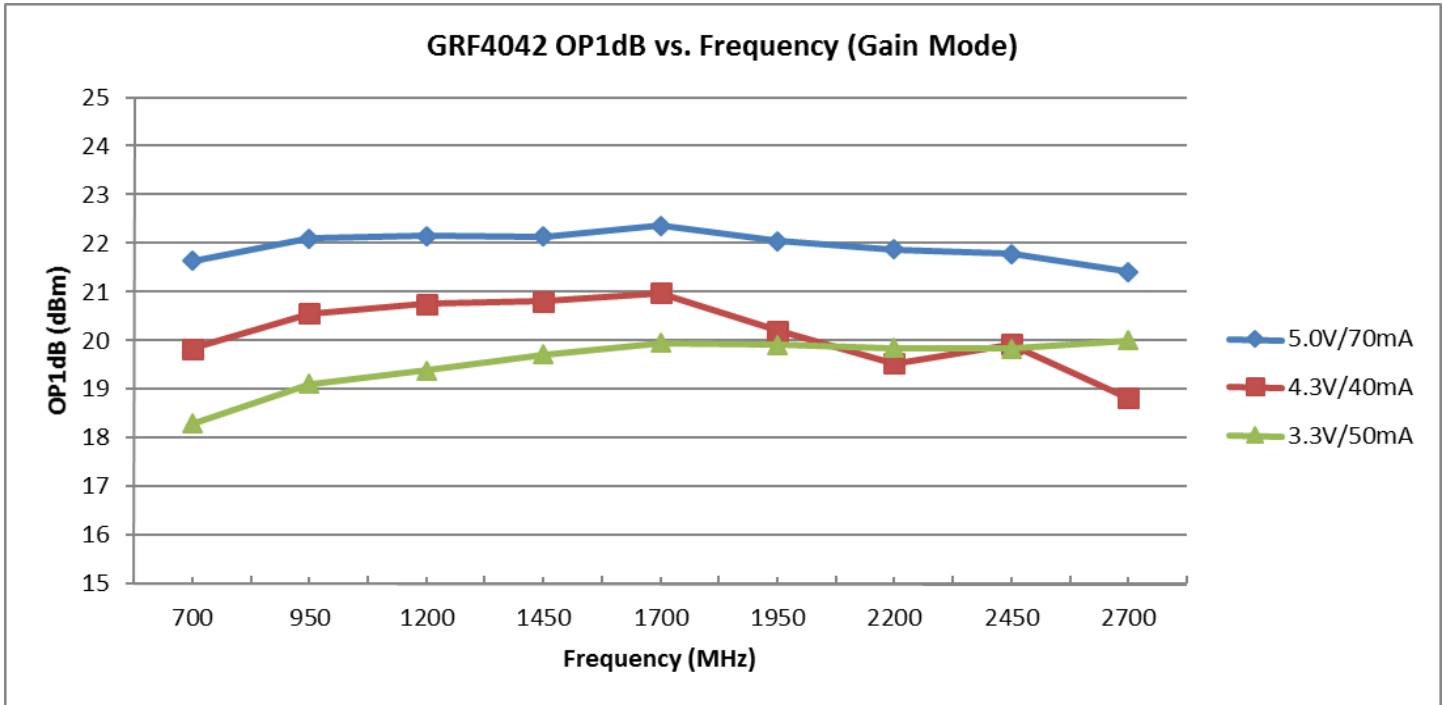



Released

GRF4042

LNA w/Bypass & Guerrilla

Armor™: 0.4 to 2.7 GHz

GRF4042 Evaluation Board Performance (Standard Broadband Match):

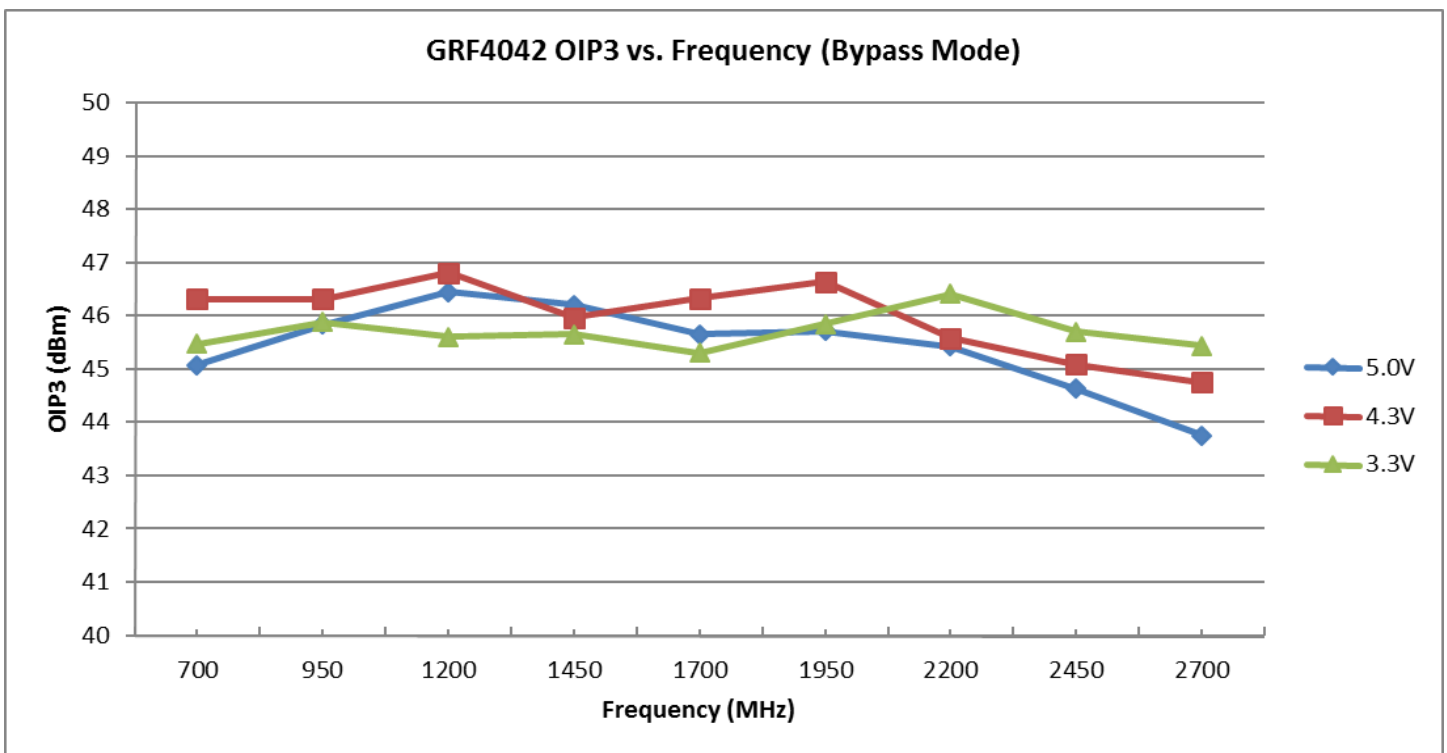
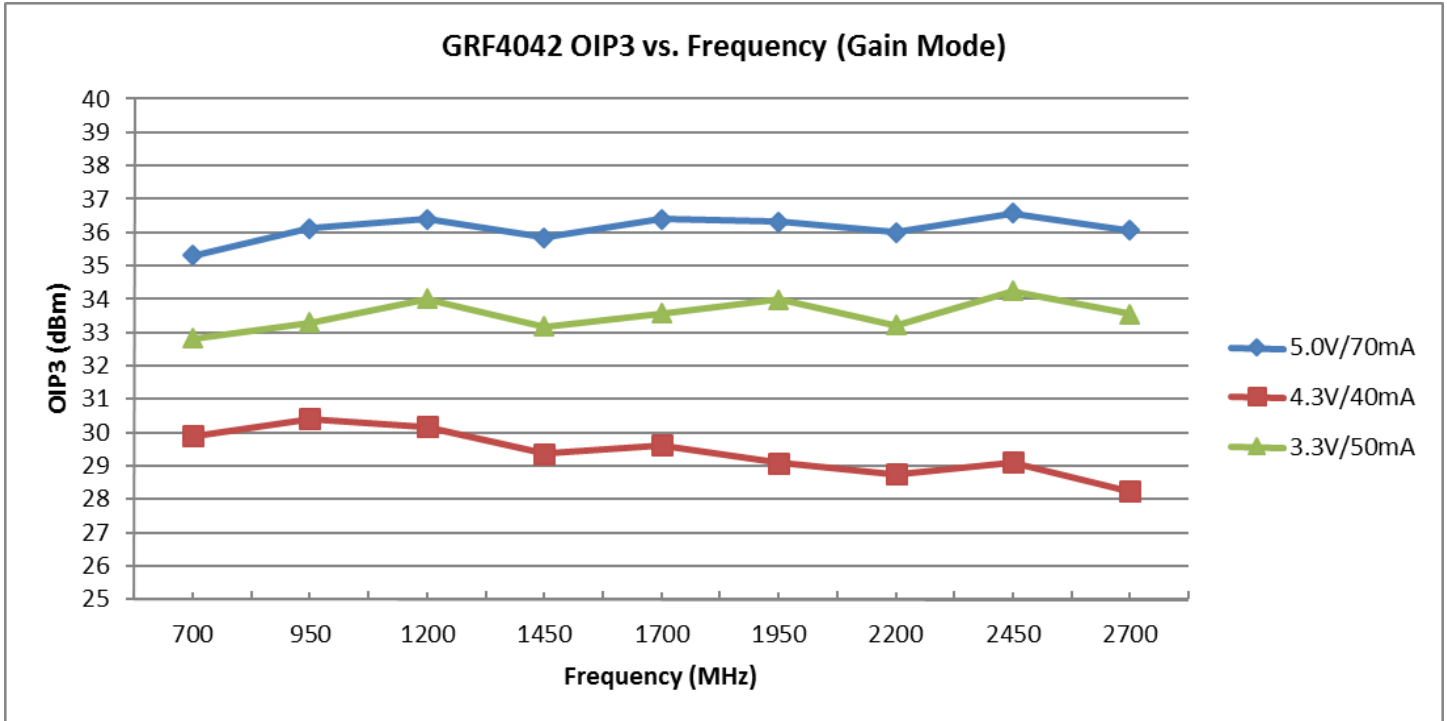



Released

GRF4042

LNA w/Bypass & Guerrilla

Armor™: 0.4 to 2.7 GHz

GRF4042 EVB Performance vs. Temp. (Standard Broadband Match):

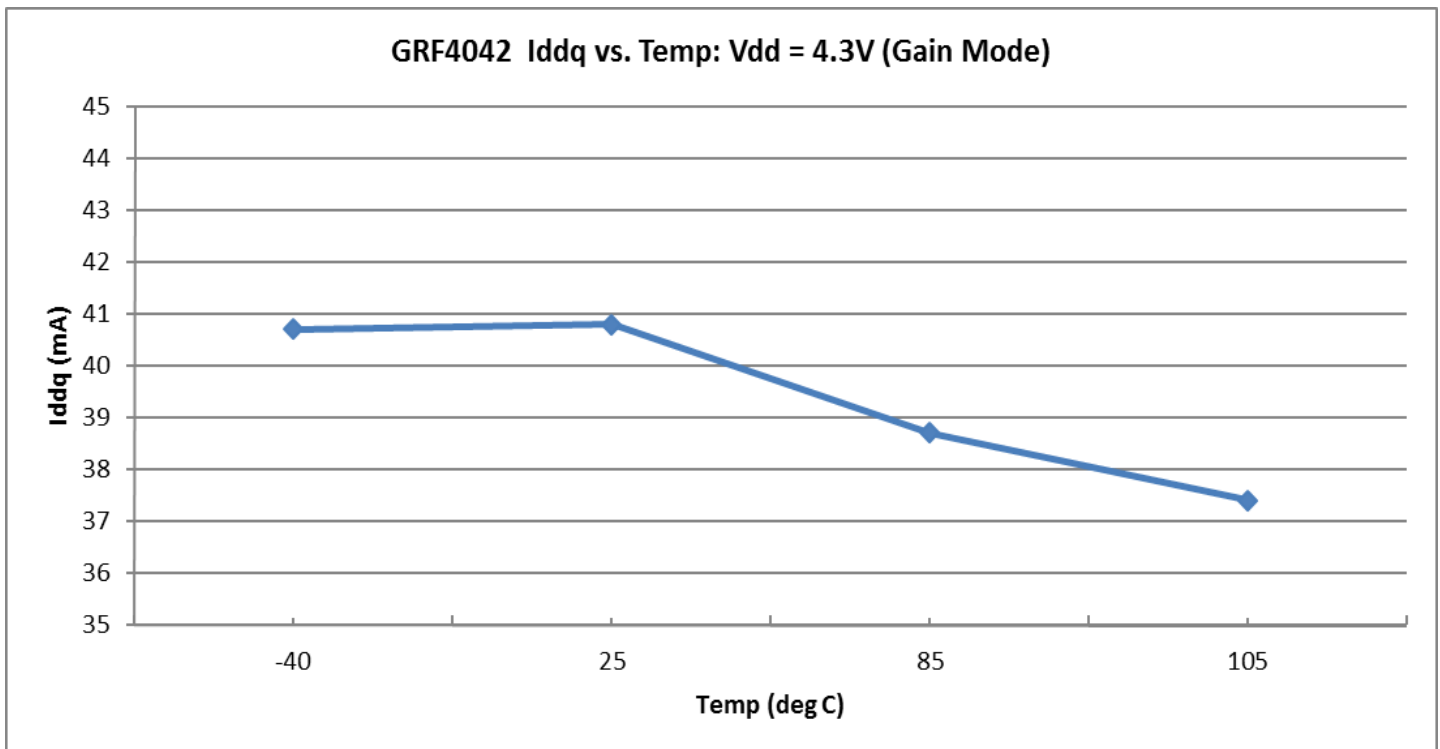
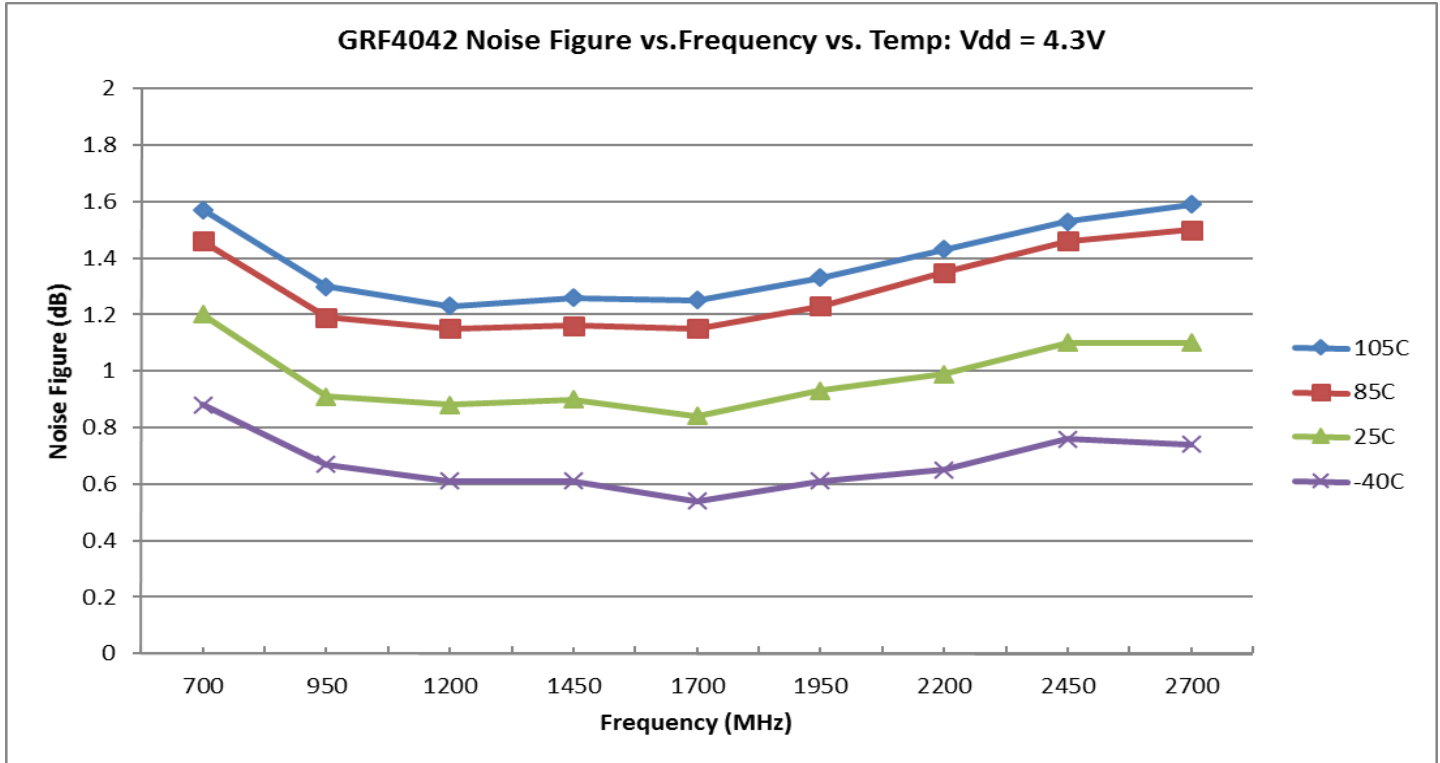



Released

GRF4042

LNA w/Bypass & Guerrilla

Armor™: 0.4 to 2.7 GHz

GRF4042 EVB Performance vs. Temp. (Standard Broadband Match):

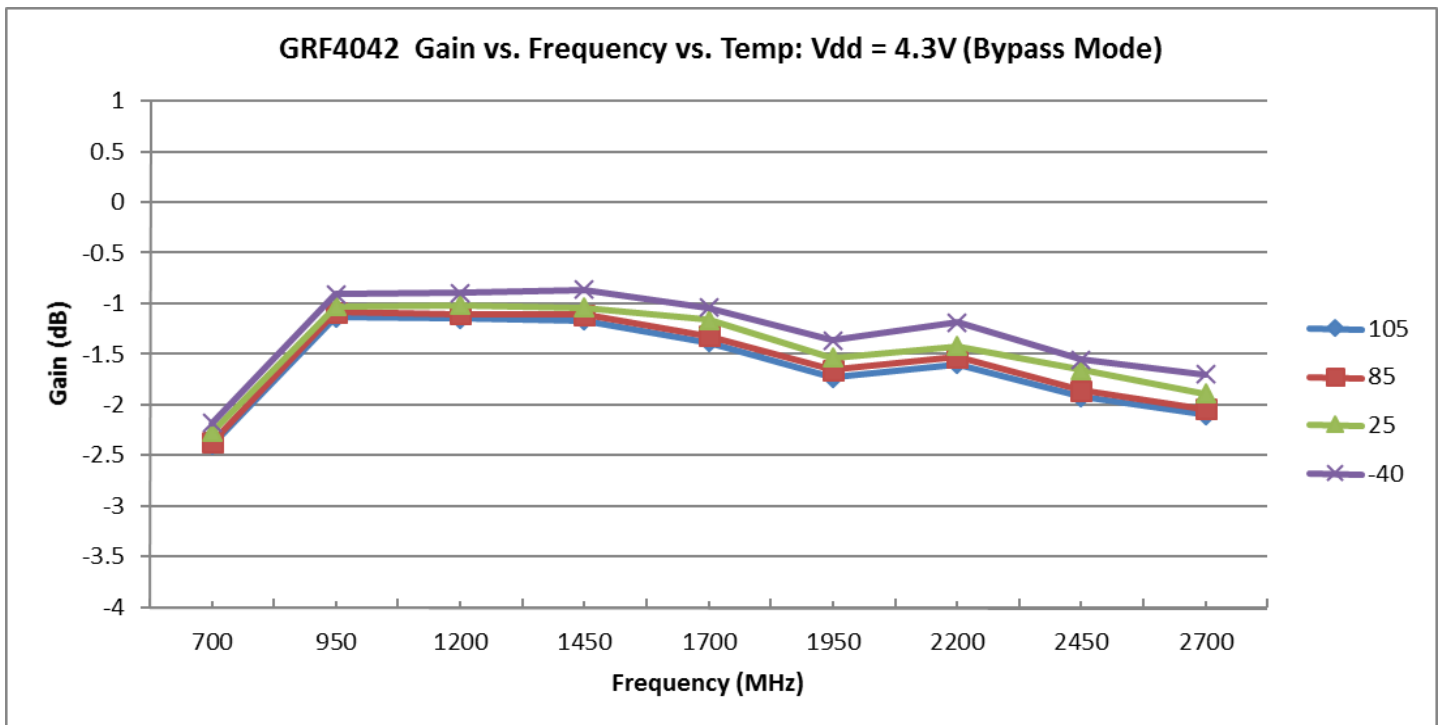
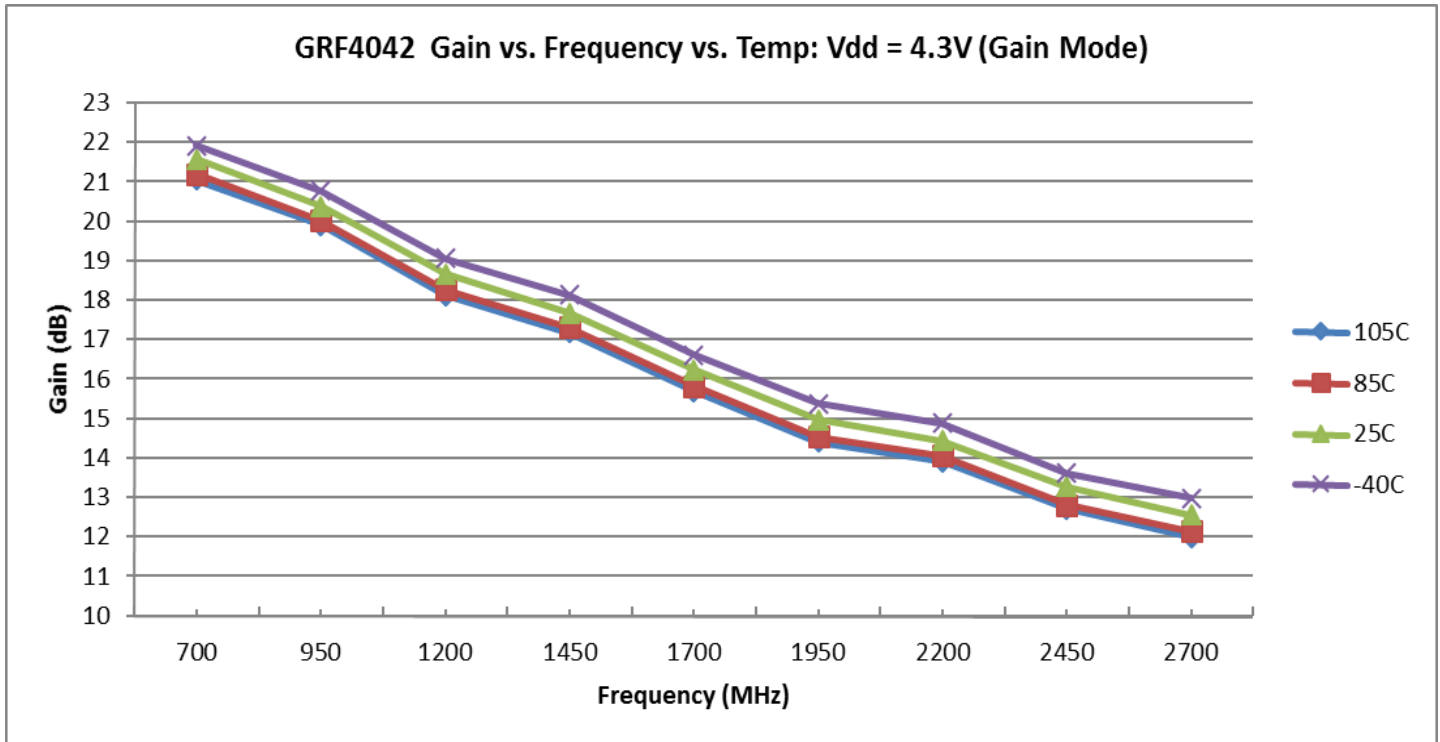



Released

GRF4042

LNA w/Bypass & Guerrilla

Armor™: 0.4 to 2.7 GHz

GRF4042 EVB Performance vs. Temp. (Standard Broadband Match):

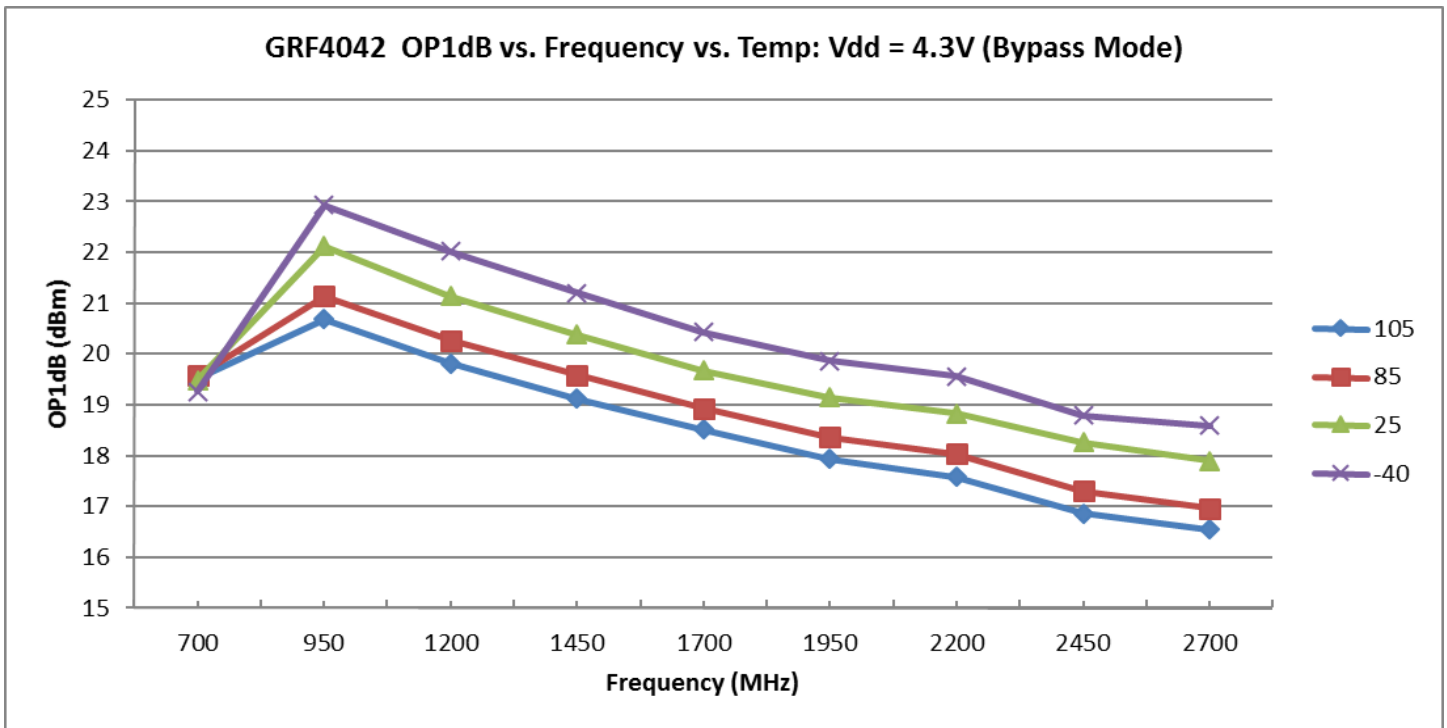
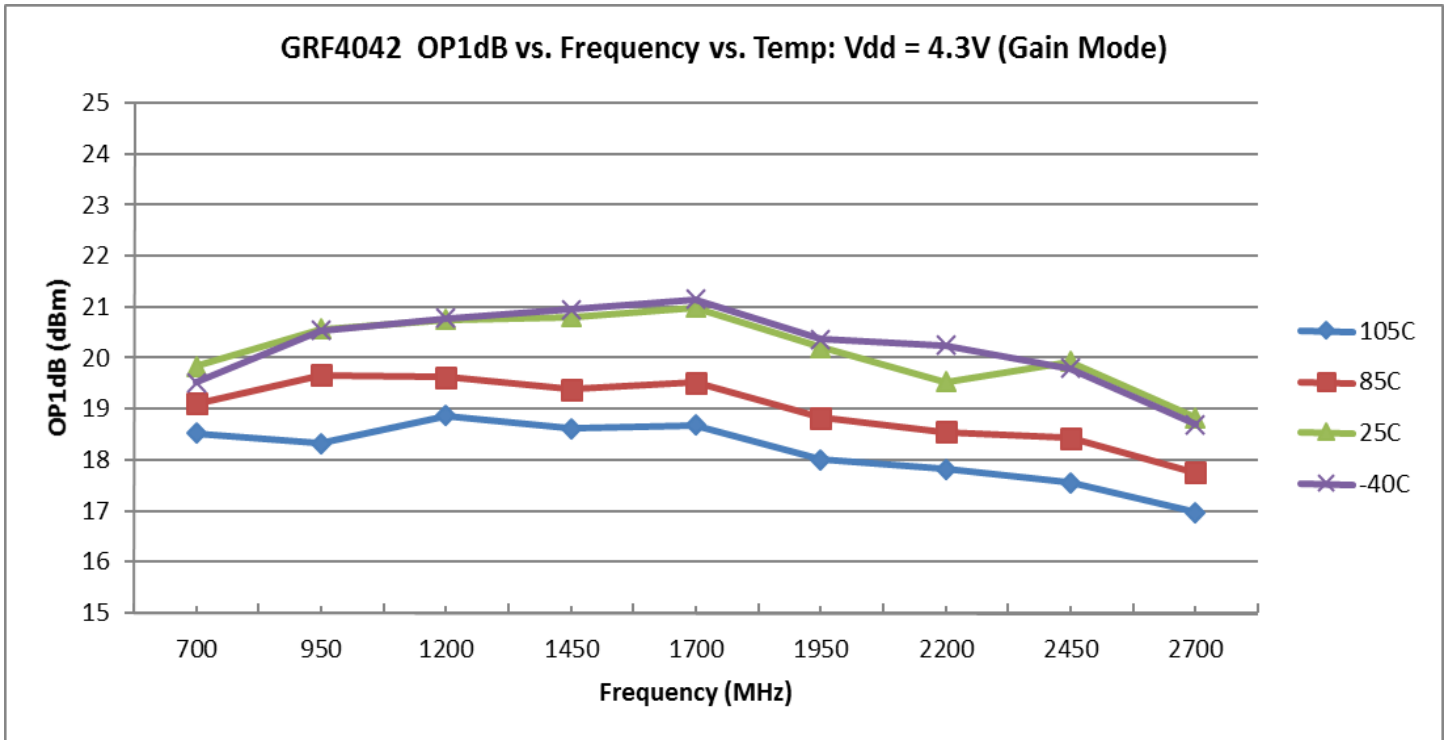



Released

GRF4042

LNA w/Bypass & Guerrilla

Armor™: 0.4 to 2.7 GHz

GRF4042 EVB Performance vs. Temp. (Standard Broadband Match):

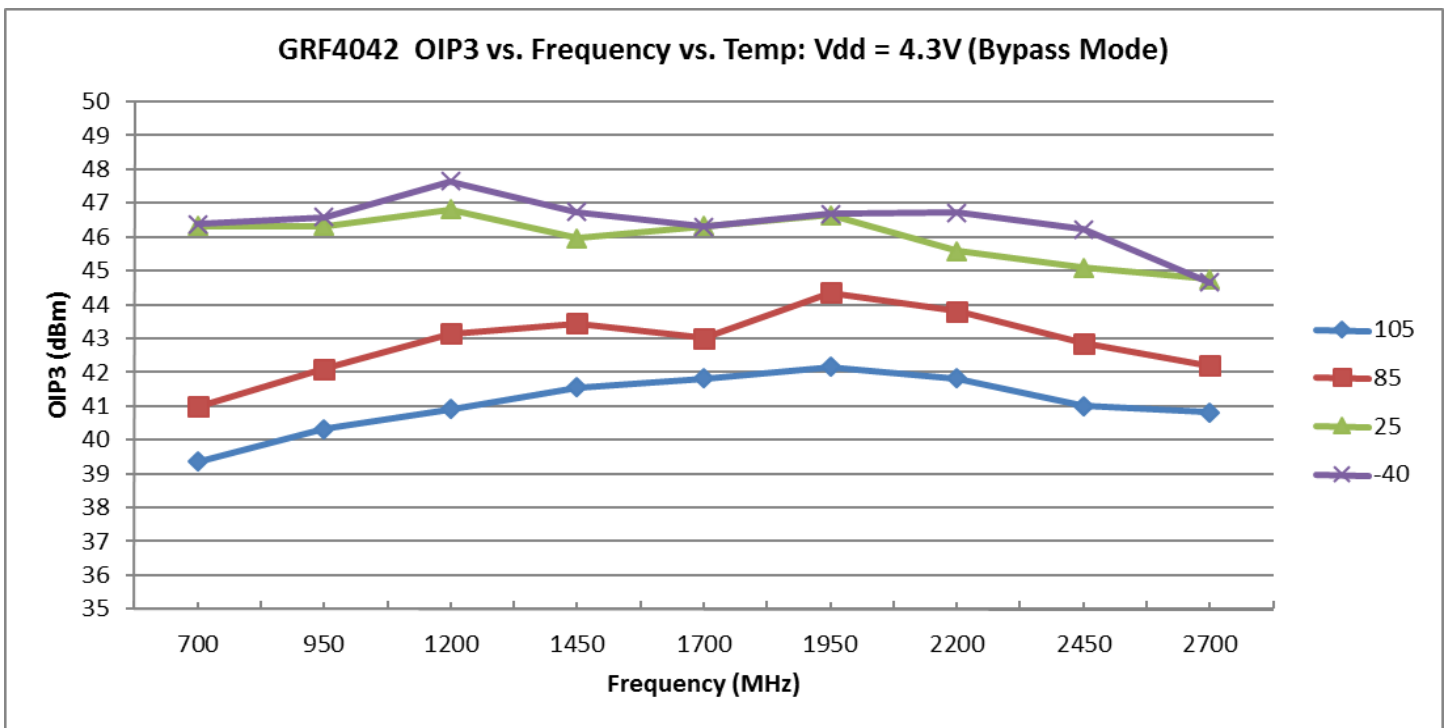
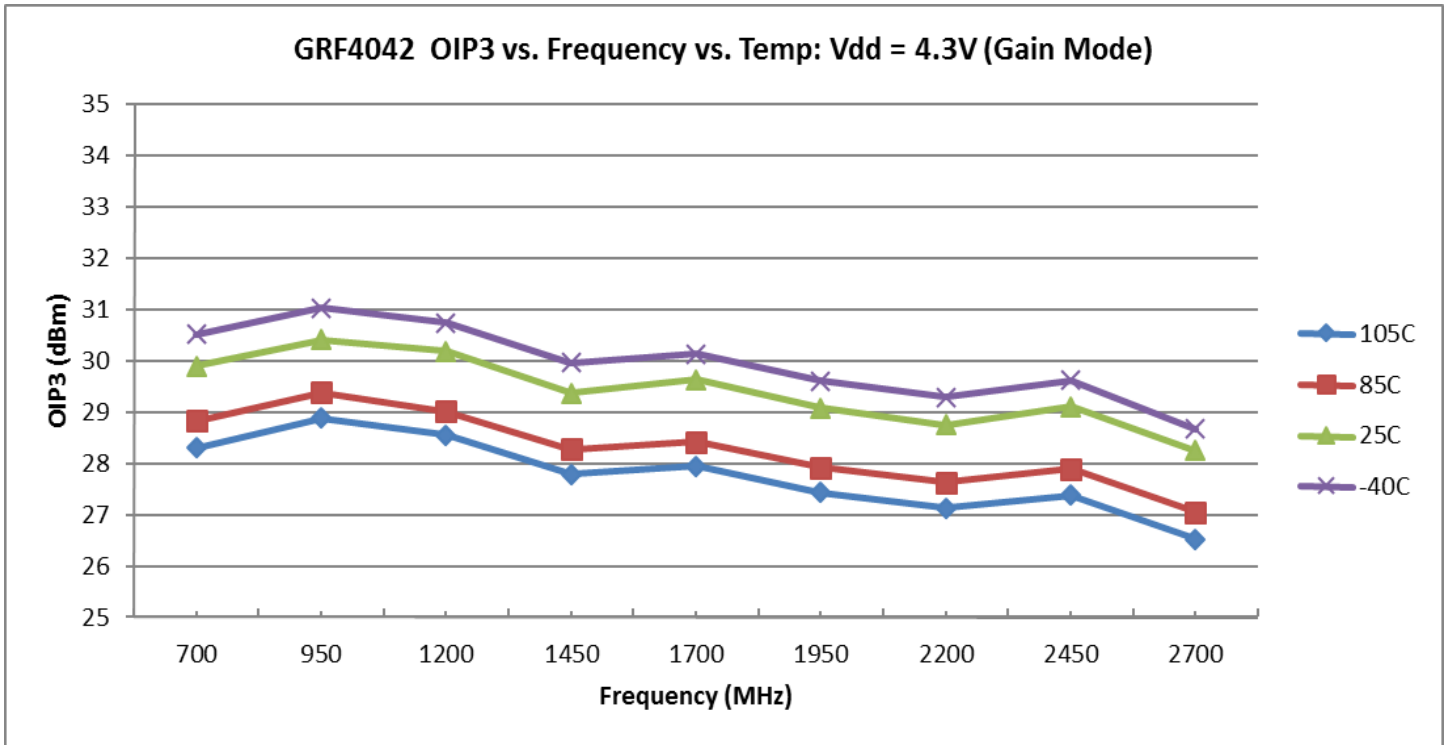



Released

GRF4042

LNA w/Bypass & Guerrilla

Armor™: 0.4 to 2.7 GHz

GRF4042 EVB S-Parameters (4.3V/40 mA): (Standard Broadband Match)

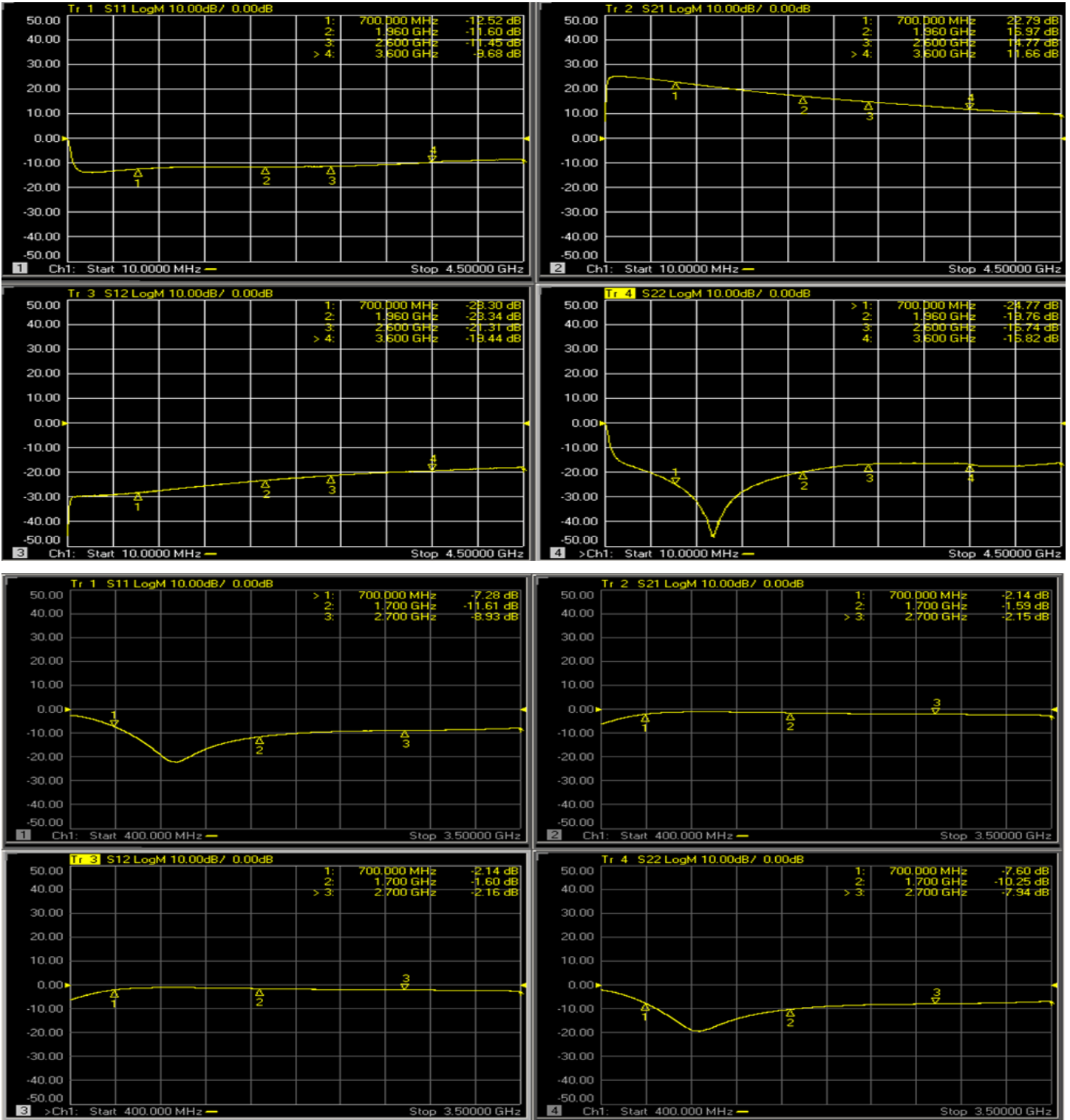

Guerrilla RF Proprietary Information. Guerrilla RF™ and the composite logo of Guerrilla RF™ are trademarks of Guerrilla RF, Inc. ©2014 Guerrilla RF, Inc. All rights reserved.



Released

GRF4042

LNA w/Bypass & Guerrilla

Armor™: 0.4 to 2.7 GHz

GRF4042 EVB Stability Mu Factor: 4.3 volts and 40 mA (Gain Mode)

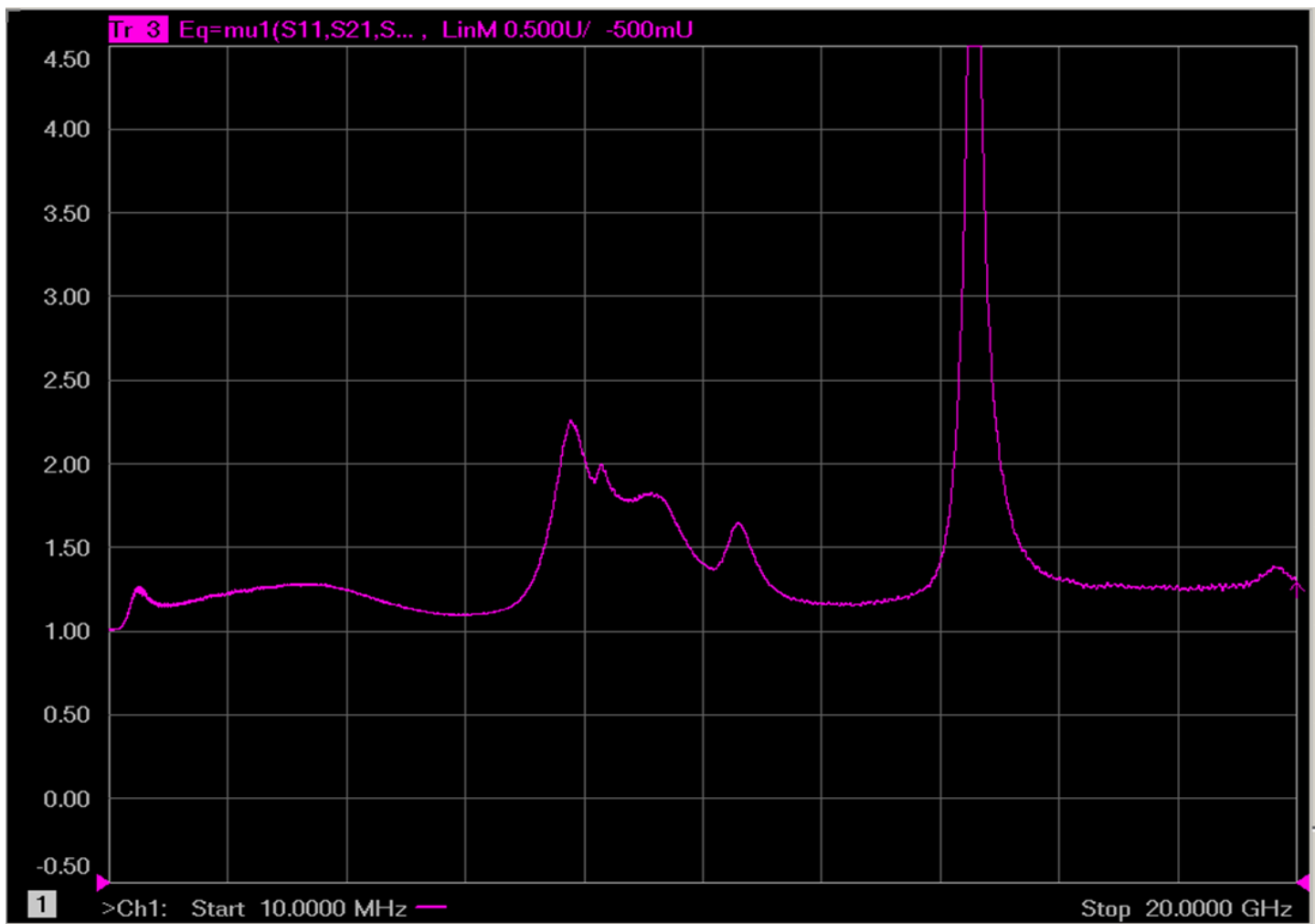

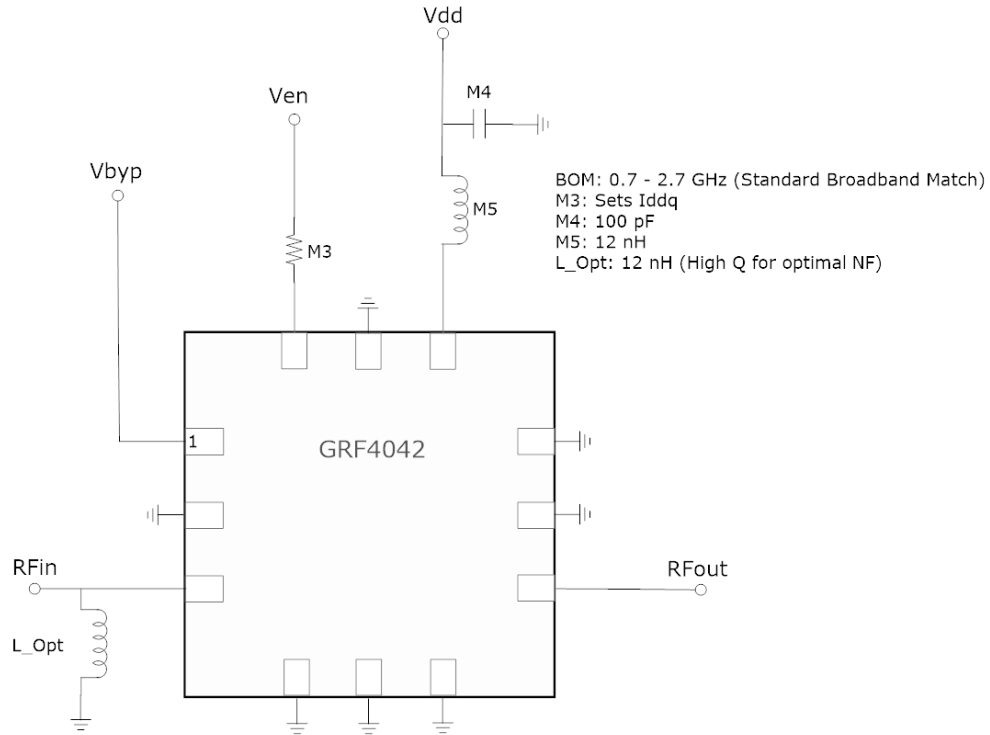

GRF4042 Standard Application Schematic

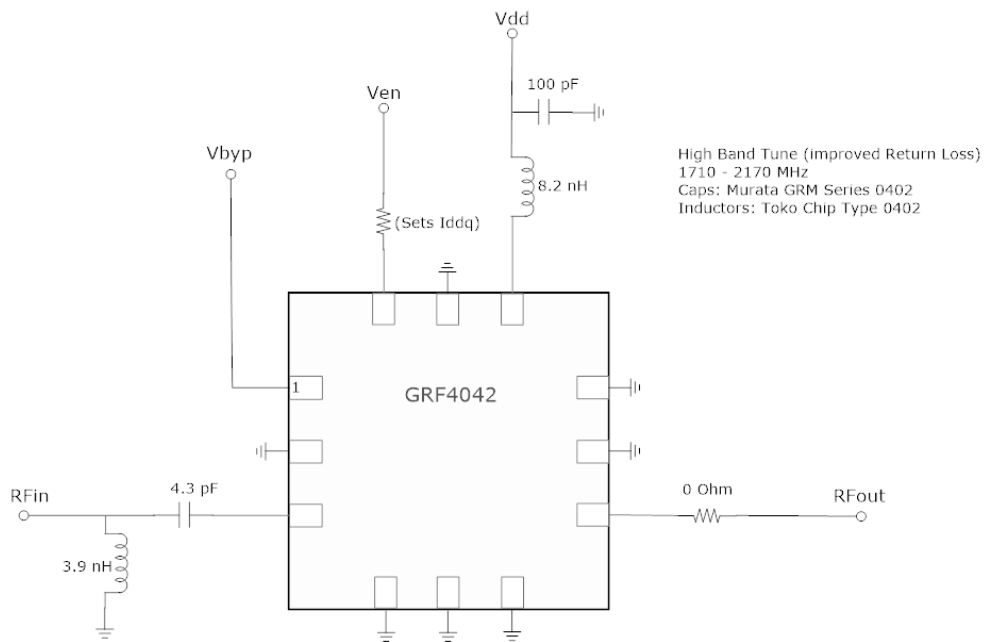
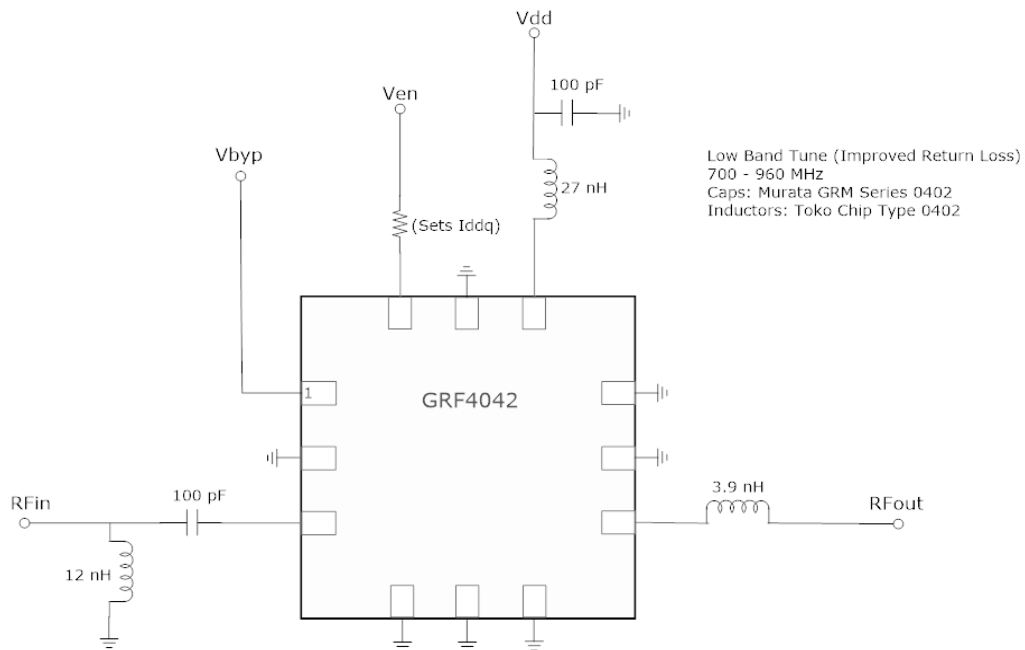

GRF4042 Low Band/High Band Application Schematics



Released

GRF4042

LNA w/Bypass & Guerrilla

Armor™: 0.4 to 2.7 GHz

GRF4042 Bias Resistor Selection Curves

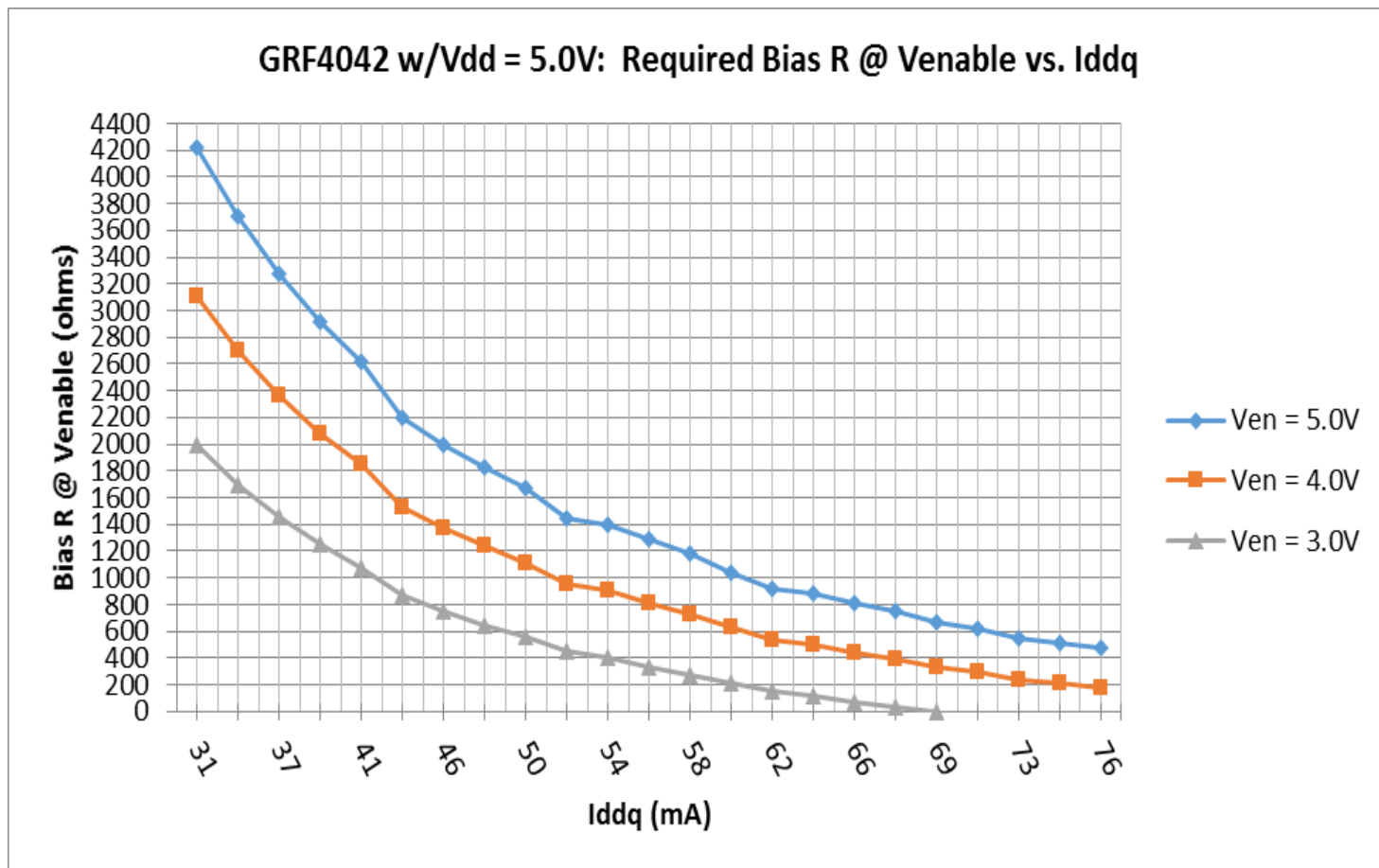

Note: Standard evaluation board bias: Vdd: 5.0V; Venable: 5.0V; M1:

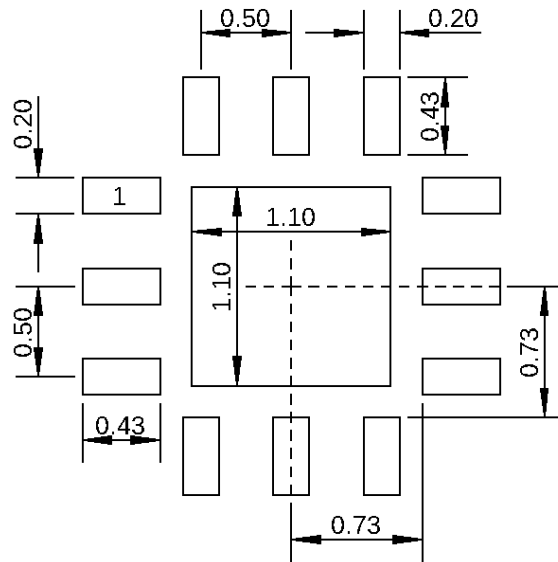

Dimensions in millimeters

2.0 mm QFN-12 Suggested PCB Footprint (Top View)

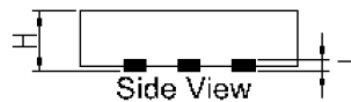
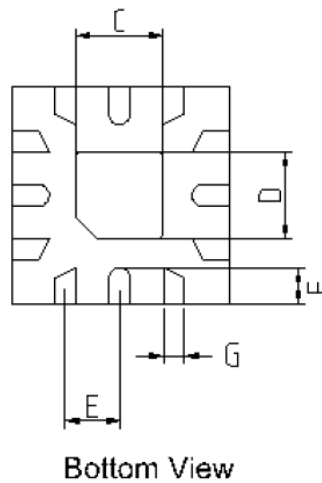
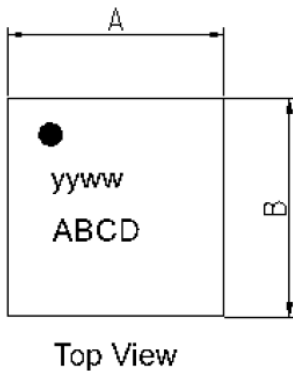

Dimensions (MM)	
A	2.00 Bsc
B	2.00 Bsc
C	.80 +/- .10
D	.80 +/- .10
E	.50 Bsc
F	.30 +/- .05
G	.20 +/- .05
H	.50 +/- .05
J	.12 Ref

2.0 mm QFN-12 Package Dimensions

Tape and Reel Information:

Guerrilla RF's Tape and Reel specification complies with the Electronics Industries Association (EIA) standards for 'Embossed Carrier Tape of Surface Mount Components for Automatic Handling'. Reference EIA-481. See the table on the following page for Tape and Reel specifications along with units per reel.

Devices are loaded with pins down into the carrier pocket with protective cover tape, wound into a plastic reel. Each reel will be packaged in a cardboard box. There will be product labels on the reel, the protective ESD bag and the outside surface of the box.

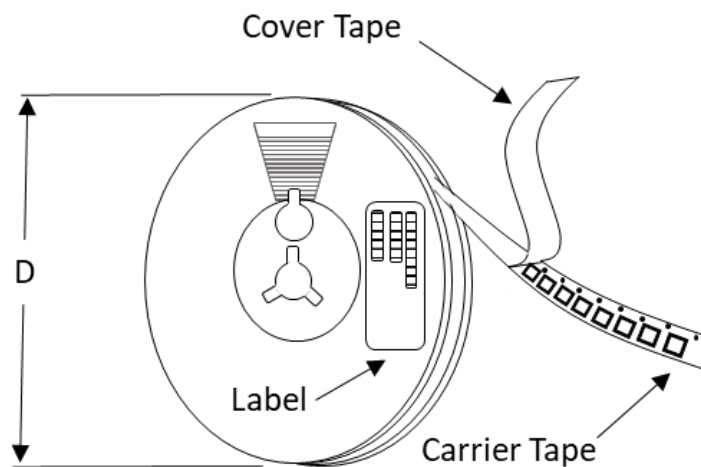

Tape and Reel Packaging with Reel Diameter Noted (D)

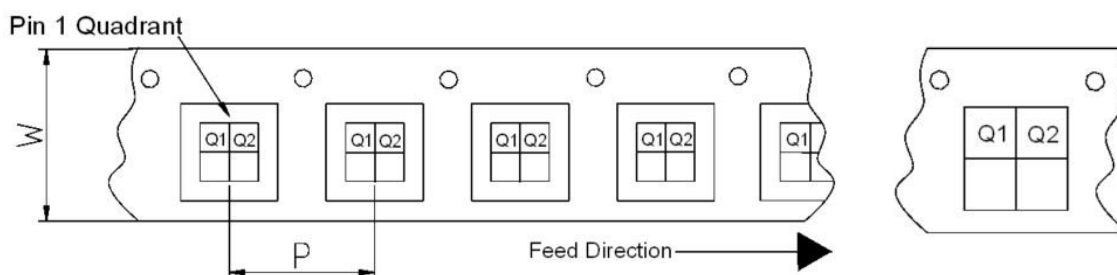

Carrier Tape Width (W), Pitch (P), Feed Direction and Pin 1 Quadrant Information



Released

GRF4042

LNA w/Bypass & Guerrilla

Armor™: 0.4 to 2.7 GHz

Tape and Reel Specification and Device Package Information Table

Package				Carrier Tape			Reel	
Type	Dimensions (mm)	Leads	Weight (mg)	Width (W) (mm)	Pocket Pitch (P) (mm)	Pin 1 Quadrant	Diameter (D) (inches)	Units per Reel
QFN	2.0 x 2.0 x 0.50	12	7	8	4	Q1	7	2500
QFN	3.0 x 3.0 x 0.85	16	24	12	8	Q1	7	1500
DFN	1.5 x 1.5 x 0.45	6	4	8	4	Q1	7	2500
DFN	2.0 x 2.0 x 0.75	8	12	8	4	Q1	7	2500
LFM	3.5 x 3.5 x 0.75	See	TBD	12	8	Q2	7	1500
LFM	4.0 x 4.0 x 0.75	See note	TBD	12	8	Q2	7	1500

Note: Lead count may vary. Reference applicable product data sheet