

165-Bump BGA  
Commercial Temp  
Industrial Temp

72Mb SigmaQuad™-II+  
Burst of 2 ECCRAM™

450 MHz–300 MHz  
1.8 V V<sub>DD</sub>  
1.5 V I/O

## Features

- 2.0 Clock Latency
- On-Chip ECC with virtually zero SER
- Simultaneous Read and Write SigmaQuad™ Interface
- JEDEC-standard pinout and package
- Dual Double Data Rate interface
- Byte Write Capability
- Burst of 2 Read and Write
- On-Die Termination (ODT) on Data (D), Byte Write ( $\overline{BW}$ ), and Clock (K,  $\overline{K}$ ) outputs
- 1.8 V +100/–100 mV core power supply
- 1.5 V HSTL Interface
- Pipelined read operation
- Fully coherent read and write pipelines
- ZQ pin for programmable output drive strength
- IEEE 1149.1 JTAG-compliant Boundary Scan
- Pin-compatible with 18Mb, 36Mb and 144Mb devices
- 165-bump, 15 mm x 17 mm, 1 mm bump pitch BGA package
- RoHS-compliant 165-bump BGA package available

## SigmaQuad™ ECCRAM Overview

The GS8672Q19/37BE are built in compliance with the SigmaQuad-II+ ECCRAM pinout standard for Separate I/O synchronous ECCRAMs. They are 75,497,472-bit (72Mb) ECCRAMs. The GS8672Q19/37BE SigmaQuad ECCRAMs are just one element in a family of low power, low voltage HSTL I/O ECCRAMs designed to operate at the speeds needed to implement economical high performance networking systems.

## Clocking and Addressing Schemes

The GS8672Q19/37BE SigmaQuad-II+ ECCRAMs are synchronous devices. They employ two input register clock inputs, K and  $\overline{K}$ . K and  $\overline{K}$  are independent single-ended clock inputs, not differential inputs to a single differential clock input buffer.

Each internal read and write operation in a SigmaQuad-II+ B2 ECCRAM is two times wider than the device I/O bus. An input data bus de-multiplexer is used to accumulate incoming data before it is simultaneously written to the memory array. An output data multiplexer is used to capture the data produced from a single memory array read and then route it to the appropriate output drivers as needed. Therefore the address field of a SigmaQuad-II+ B2 ECCRAM is always one address pin less than the advertised index depth (e.g., the 4M x18 has an 2M addressable index).

## On-Chip Error Correction Code

GSI's ECCRAMs implement an ECC algorithm that detects and corrects all single-bit memory errors, including those induced by Soft Error Rate (SER) events such as cosmic rays, alpha particles. The resulting SER of these devices is anticipated to be <0.002 FITs/Mb — a 5-order-of-magnitude improvement over comparable ECCRAMs with no On-Chip ECC, which typically have an SER of 200 FITs/Mb or more. SER quoted above is based on reading taken at sea level.

However, the On-Chip Error Correction (ECC) will be disabled if a “Half Write” operation is initiated. See the **Byte Write Control** section for further information.

## Parameter Synopsis

	-450	-400	-375	-333	-300
tKHKH	2.2 ns	2.5 ns	2.67 ns	3.0 ns	3.3 ns
tKHQV	0.45 ns	0.45 ns	0.45 ns	0.45 ns	0.45 ns

## 2M x 36 SigmaQuad-II+ ECCRAM—Top View

	1	2	3	4	5	6	7	8	9	10	11
A	$\overline{\text{CQ}}$	NC (288Mb)	SA	$\overline{\text{W}}$	$\overline{\text{BW2}}$	$\overline{\text{K}}$	$\overline{\text{BW1}}$	$\overline{\text{R}}$	SA	NF (144Mb)	CQ
B	Q27	Q18	D18	SA	$\overline{\text{BW3}}$	K	$\overline{\text{BW0}}$	SA	D17	Q17	Q8
C	D27	Q28	D19	V <sub>SS</sub>	SA	SA	SA	V <sub>SS</sub>	D16	Q7	D8
D	D28	D20	Q19	V <sub>SS</sub>	V <sub>SS</sub>	V <sub>SS</sub>	V <sub>SS</sub>	V <sub>SS</sub>	Q16	D15	D7
E	Q29	D29	Q20	V <sub>DDQ</sub>	V <sub>SS</sub>	V <sub>SS</sub>	V <sub>SS</sub>	V <sub>DDQ</sub>	Q15	D6	Q6
F	Q30	Q21	D21	V <sub>DDQ</sub>	V <sub>DD</sub>	V <sub>SS</sub>	V <sub>DD</sub>	V <sub>DDQ</sub>	D14	Q14	Q5
G	D30	D22	Q22	V <sub>DDQ</sub>	V <sub>DD</sub>	V <sub>SS</sub>	V <sub>DD</sub>	V <sub>DDQ</sub>	Q13	D13	D5
H	$\overline{\text{Doff}}$	V <sub>REF</sub>	V <sub>DDQ</sub>	V <sub>DDQ</sub>	V <sub>DD</sub>	V <sub>SS</sub>	V <sub>DD</sub>	V <sub>DDQ</sub>	V <sub>DDQ</sub>	V <sub>REF</sub>	ZQ
J	D31	Q31	D23	V <sub>DDQ</sub>	V <sub>DD</sub>	V <sub>SS</sub>	V <sub>DD</sub>	V <sub>DDQ</sub>	D12	Q4	D4
K	Q32	D32	Q23	V <sub>DDQ</sub>	V <sub>DD</sub>	V <sub>SS</sub>	V <sub>DD</sub>	V <sub>DDQ</sub>	Q12	D3	Q3
L	Q33	Q24	D24	V <sub>DDQ</sub>	V <sub>SS</sub>	V <sub>SS</sub>	V <sub>SS</sub>	V <sub>DDQ</sub>	D11	Q11	Q2
M	D33	Q34	D25	V <sub>SS</sub>	V <sub>SS</sub>	V <sub>SS</sub>	V <sub>SS</sub>	V <sub>SS</sub>	D10	Q1	D2
N	D34	D26	Q25	V <sub>SS</sub>	SA	SA	SA	V <sub>SS</sub>	Q10	D9	D1
P	Q35	D35	Q26	SA	SA	QVLD	SA	SA	Q9	D0	Q0
R	TDO	TCK	SA	SA	SA	ODT	SA	SA	SA	TMS	TDI

 11 x 15 Bump BGA—15 x 17 mm<sup>2</sup> Body—1 mm Bump Pitch

**Notes:**

1.  $\overline{\text{BW0}}$  controls writes to D0:D8;  $\overline{\text{BW1}}$  controls writes to D9:D17;  $\overline{\text{BW2}}$  controls writes to D18:D26;  $\overline{\text{BW3}}$  controls writes to D27:D35.
2. Pins A2 and A10 are the expansion addresses.

## 4M x 18 SigmaQuad-II+ ECCRAM—Top View

	1	2	3	4	5	6	7	8	9	10	11
A	$\overline{CQ}$	NC (144Mb)	SA	$\overline{W}$	$\overline{BW1}$	$\overline{K}$	NF	$\overline{R}$	SA	SA	CQ
B	NC	Q9	D9	SA	NF	K	$\overline{BW0}$	SA	NC	NC	Q8
C	NC	NC	D10	$V_{SS}$	SA	SA	SA	$V_{SS}$	NC	Q7	D8
D	NC	D11	Q10	$V_{SS}$	$V_{SS}$	$V_{SS}$	$V_{SS}$	$V_{SS}$	NC	NC	D7
E	NC	NC	Q11	$V_{DDQ}$	$V_{SS}$	$V_{SS}$	$V_{SS}$	$V_{DDQ}$	NC	D6	Q6
F	NC	Q12	D12	$V_{DDQ}$	$V_{DD}$	$V_{SS}$	$V_{DD}$	$V_{DDQ}$	NC	NC	Q5
G	NC	D13	Q13	$V_{DDQ}$	$V_{DD}$	$V_{SS}$	$V_{DD}$	$V_{DDQ}$	NC	NC	D5
H	$\overline{Doff}$	$V_{REF}$	$V_{DDQ}$	$V_{DDQ}$	$V_{DD}$	$V_{SS}$	$V_{DD}$	$V_{DDQ}$	$V_{DDQ}$	$V_{REF}$	ZQ
J	NC	NC	D14	$V_{DDQ}$	$V_{DD}$	$V_{SS}$	$V_{DD}$	$V_{DDQ}$	NC	Q4	D4
K	NC	NC	Q14	$V_{DDQ}$	$V_{DD}$	$V_{SS}$	$V_{DD}$	$V_{DDQ}$	NC	D3	Q3
L	NC	Q15	D15	$V_{DDQ}$	$V_{SS}$	$V_{SS}$	$V_{SS}$	$V_{DDQ}$	NC	NC	Q2
M	NC	NC	D16	$V_{SS}$	$V_{SS}$	$V_{SS}$	$V_{SS}$	$V_{SS}$	NC	Q1	D2
N	NC	D17	Q16	$V_{SS}$	SA	SA	SA	$V_{SS}$	NC	NC	D1
P	NC	NC	Q17	SA	SA	QVLD	SA	SA	NC	D0	Q0
R	TDO	TCK	SA	SA	SA	ODT	SA	SA	SA	TMS	TDI

 11 x 15 Bump BGA—15 x 17 mm<sup>2</sup> Body—1 mm Bump Pitch

## Notes:

1.  $\overline{BW0}$  controls writes to D0:D8.  $\overline{BW1}$  controls writes to D9:D17.
2. Pin A2 is the expansion address.

## Pin Description Table

Symbol	Description	Type	Comments
SA	Synchronous Address Inputs	Input	—
$\overline{R}$	Synchronous Read	Input	Active Low
$\overline{W}$	Synchronous Write	Input	Active Low
$\overline{BW0-BW3}$	Synchronous Byte Writes	Input	Active Low
K	Input Clock	Input	Active High
$\overline{K}$	Input Clock	Input	Active Low
TMS	Test Mode Select	Input	—
TDI	Test Data Input	Input	—
TCK	Test Clock Input	Input	—
TDO	Test Data Output	Output	—
V <sub>REF</sub>	HSTL Input Reference Voltage	Input	—
ZQ	Output Impedance Matching Input	Input	—
Qn	Synchronous Data Outputs	Output	—
Dn	Synchronous Data Inputs	Input	—
$\overline{Doff}$	Disable DLL when low	Input	Active Low
CQ	Output Echo Clock	Output	—
$\overline{CQ}$	Output Echo Clock	Output	—
V <sub>DD</sub>	Power Supply	Supply	1.8 V Nominal
V <sub>DDQ</sub>	Isolated Output Buffer Supply	Supply	1.5 V Nominal
V <sub>SS</sub>	Power Supply: Ground	Supply	—
QVLD	Q Valid Output	Output	—
ODT	On-Die Termination	Input	—
NC	No Connect	—	—
NF	No Function	—	—

## Notes:

1. NC = Not Connected to die or any other pin
2. NF= No Function. There is an electrical connection to this input pin, but the signal has no function in the device. It can be left unconnected, or tied to V<sub>SS</sub> or V<sub>DDQ</sub>.
3. K, or  $\overline{K}$  cannot be set to V<sub>REF</sub> voltage.

## Background

Separate I/O SRAMs, from a system architecture point of view, are attractive in applications where alternating reads and writes are needed. Therefore, the SigmaQuad-II+ ECCRAM interface and truth table are optimized for alternating reads and writes. Separate I/O SRAMs are unpopular in applications where multiple reads or multiple writes are needed because burst read or write transfers from Separate I/O SRAMs can cut the RAM's bandwidth in half.

### SigmaQuad-II+ B2 ECCRAM DDR Read

The read port samples the status of the Address Input and  $\overline{R}$  pins at each rising edge of K. A low on the Read Enable pin,  $\overline{R}$ , begins a read cycle. Data can be clocked out after the next rising edge of K with a rising edge of  $\overline{K}$ , and after the following rising edge of  $\overline{K}$  with a rising edge of K. Clocking in a high on the Read Enable pin,  $\overline{R}$ , begins a read port deselect cycle.

### SigmaQuad-II+ B2 ECCRAM DDR Write

The write port samples the status of the  $\overline{W}$  pin at each rising edge of K and the Address Input pins on the following rising edge of  $\overline{K}$ . A low on the Write Enable pin,  $\overline{W}$ , begins a write cycle. The first of the data-in pairs associated with the write command is clocked in with the same rising edge of K used to capture the write command. The second of the two data in transfers is captured on the rising edge of  $\overline{K}$  along with the write address. Clocking in a high on  $\overline{W}$  causes a write port deselect cycle.

## Power-Up Sequence for SigmaQuad-II+ ECCRAMs

SigmaQuad-II+ ECCRAMs must be powered-up in a specific sequence in order to avoid undefined operations.

1. After power supplies power-up and clocks ( $K$ ,  $\bar{K}$ ) are stabilized, 163,840 cycles are required to set Output Driver Impedance.
2. Thereafter, an additional 65,536 clock cycles are required to lock the DLL after it has been enabled.
3. Begin Read and Write operations.

For more information, read **AN1021 SigmaQuad and SigmaDDR Power-Up**.

## On-Chip Error Correction

SigmaQuad-II+ ECCRAMs implement a single-bit error detection and correction algorithm (specifically, a Hamming Code) on each DDR data word (comprising two 9-bit data bytes) transmitted on each 9-bit data bus (i.e., transmitted on D/Q[8:0], D/Q[17:9], D/Q[26:18], or D/Q[35:27]). To accomplish this, 5 ECC parity bits (invisible to the user) are utilized per every 18 data bits (visible to the user).

The ECC algorithm neither corrects nor detects multi-bit errors. However, GSI ECCRAMs are architected in such a way that a single SER event very rarely causes a multi-bit error across any given "transmitted data unit", where a "transmitted data unit" represents the data transmitted as the result of a single read or write operation to a particular address. The extreme rarity of multi-bit errors results in the SER mentioned previously (i.e., <0.002 FITs/Mb measured at sea level).

Not only does the on-chip ECC significantly improve SER performance, but it also frees up the entire memory array for data storage. Very often SRAM applications allocate 1/9th of the memory array (i.e., one "error bit" per eight "data bits", in any 9-bit "data byte") for error detection (either simple parity error detection, or system-level ECC error detection and correction). Such error-bit allocation is unnecessary with ECCRAMs—the entire memory array can be utilized for data storage, effectively providing 12.5% greater storage capacity compared to SRAMs of the same density not equipped with on-chip ECC.

## Special Functions

### Byte Write Control

Byte Write Enable pins are sampled at the same time that Data In is sampled. A High on the Byte Write Enable pin associated with a particular byte (e.g.,  $\overline{BW0}$  controls D0–D8 inputs) will inhibit the storage of that particular byte, leaving whatever data may be stored at the current address at that byte location undisturbed. Any or all of the Byte Write Enable pins may be driven High or Low during the data in sample times in a write sequence.

Each write enable command and write address loaded into the RAM provides the base address for a 2-beat data transfer. The x18 version of the RAM, for example, may write 36 bits in association with each address loaded. Any 9-bit byte may be masked in any write sequence.

**Note:** If “Half Write” operations (i.e., write operations in which a  $\overline{BWn}$  pin is asserted for only half of a DDR write data transfer on the associated 9-bit data bus, causing only 9 bits of the 18-bit DDR data word to be written) are initiated, the on-chip ECC will be disabled for as long as the SRAM remains powered up thereafter. This must be done because ECC is implemented across entire 18-bit data words, rather than across individual 9-bit data bytes.

### Byte Write Truth Table

The truth table below applies to write operations to Address "m", where Address "m" is the 18-bit memory location comprising the 2 beats of DDR write data associated with each  $\overline{BWn}$  pin in a given clock cycle.

$\overline{BWn}$		Input Data Byte $n$		Operation	Result
$\uparrow K$ (Beat 1)	$\uparrow \overline{K}$ (Beat 2)	$\uparrow K$ (Beat 1)	$\uparrow \overline{K}$ (Beat 2)		
0	0	D0	D1	Full Write	D0 and D1 written to Address m
0	1	D0	X	Half Write	Only D0 written to Address m
1	0	X	D1	Half Write	Only D1 written to Address m
1	1	X	X	Abort	Address m unchanged

#### Notes:

- $\overline{BW0}$  is associated with Input Data Byte D[8:0].
- $\overline{BW1}$  is associated with Input Data Byte D[17:9].
- $\overline{BW2}$  is associated with Input Data Byte D[26:18] (in x36 only).
- $\overline{BW3}$  is associated with Input Data Byte D[35:27] (in x36 only).
- ECC is disabled if a “Half Write” operation is initiated.

### FLXDrive-II Output Driver Impedance Control

HSTL I/O SigmaQuad-II+ ECCRAMs are supplied with programmable impedance output drivers. The ZQ pin must be connected to  $V_{SS}$  via an external resistor, RQ, to allow the ECCRAM to monitor and adjust its output driver impedance. The value of RQ must be 5X the value of the desired RAM output impedance. The allowable range of RQ to guarantee impedance matching continuously is between  $175\Omega$  and  $350\Omega$ . Periodic readjustment of the output driver impedance is necessary as the impedance is affected by drifts in supply voltage and temperature. The ECCRAM's output impedance circuitry compensates for drifts in supply voltage and temperature. A clock cycle counter periodically triggers an impedance evaluation, resets and counts again. Each impedance evaluation may move the output driver impedance level one step at a time towards the optimum level. The output driver is implemented with discrete binary weighted impedance steps.

### Input Termination Impedance Control

These SigmaQuad-II+ ECCRAMs are supplied with programmable input termination on Data (D), Byte Write ( $\overline{B\overline{W}}$ ), and Clock ( $K/\overline{K}$ ) input receivers. Input termination can be enabled or disabled via the ODT pin (6R). When the ODT pin is tied Low (or left floating -the pin has a small pull-down resistor), input termination is disabled. When the ODT pin is tied High, input termination is enabled. Termination impedance is programmed via the same RQ resistor (connected between the ZQ pin and  $V_{SS}$ ) used to program output driver impedance, and is nominally  $RQ \cdot 0.6$  Thevenin-equivalent when RQ is between  $175\Omega$  and  $250\Omega$ . Periodic readjustment of the termination impedance occurs to compensate for drifts in supply voltage and temperature, in the same manner as for driver impedance (see above).

#### Note:

When  $ODT = 1$ , Data (D), Byte Write ( $\overline{B\overline{W}}$ ), and Clock ( $K, \overline{K}$ ) input termination is always enabled. Consequently, D,  $\overline{B\overline{W}}$ , K,  $\overline{K}$  inputs should always be driven High or Low; they should never be tri-stated (i.e., in a High-Z state). If the inputs are tri-stated, the input termination will pull the signal to  $V_{DDQ}/2$  (i.e., to the switch point of the diff-amp receiver), which could cause the receiver to enter a meta-stable state, resulting in the receiver consuming more power than it normally would. This could result in the device's operating currents being higher.



**Separate I/O SigmaQuad-II+ ECCRAM Read Truth Table**

A	$\bar{R}$	Output Next State	Q	Q
$K \uparrow$ ( $t_n$ )	$K \uparrow$ ( $t_n$ )	$K \uparrow$ ( $t_n$ )	$K \uparrow$ ( $t_{n+2}$ )	$\bar{K} \uparrow$ ( $t_{n+2\frac{1}{2}}$ )
X	1	Deselect	Hi-Z/0	Hi-Z/0
V	0	Read	Q0	Q1

**Notes:**

1. X = Don't Care, 1 = High, 0 = Low, V = Valid.
2. R is evaluated on the rising edge of K.
3. Q0 and Q1 are the first and second data output transfers in a read.
4. Users should not clock in metastable addresses.
5. When On-Die Termination is disabled (ODT = 0), Q drivers are disabled (i.e., Q pins are tri-stated) for one cycle in response to NOP and Write commands, 2.0 cycles after the command is sampled.
6. When On-Die Termination is enabled (ODT = 1), Q drivers are enabled Low (i.e., Q pins are driven Low) for one cycle in response to NOP and Write commands, 2.0 cycles after the command is sampled. This is done so that the ASIC/Controller can enable On-Die Termination on its data inputs without having to cope with the termination pulling tri-stated data inputs to  $V_{DDQ}/2$  (i.e., to the switch point of the data input receivers).

**Separate I/O SigmaQuad-II+ ECCRAM Write Truth Table**

A	$\bar{W}$	$\overline{BWn}$	$\overline{BWn}$	Input Next State	D	D
$\bar{K} \uparrow$ ( $t_{n+\frac{1}{2}}$ )	$K \uparrow$ ( $t_n$ )	$K \uparrow$ ( $t_n$ )	$\bar{K} \uparrow$ ( $t_{n+\frac{1}{2}}$ )	$K \uparrow, \bar{K} \uparrow$ ( $t_n, t_{n+\frac{1}{2}}$ )	$K \uparrow$ ( $t_n$ )	$\bar{K} \uparrow$ ( $t_{n+\frac{1}{2}}$ )
V	0	0	0	Write Byte Dx0, Write Byte Dx1	D0	D1
V	0	0	1	Write Byte Dx0, Write Abort Byte Dx1	D0	X
V	0	1	0	Write Abort Byte Dx0, Write Byte Dx1	X	D1
X	0	1	1	Write Abort Byte Dx0, Write Abort Byte Dx1	X	X
X	1	X	X	Deselect	X	X

**Notes:**

1. X = Don't Care, H = High, L = Low, V = Valid.
2.  $\bar{W}$  is evaluated on the rising edge of K.
3. D0 and D1 are the first and second data input transfers in a write.
4.  $\overline{BWn}$  represents any of the Byte Write Enable inputs ( $\overline{BW0}$ ,  $\overline{BW1}$ , etc.).

**x36 Byte Write Enable ( $\overline{BWn}$ ) Truth Table**

$\overline{BW0}$	$\overline{BW1}$	$\overline{BW2}$	$\overline{BW3}$	D0–D8	D9–D17	D18–D26	D27–D35
1	1	1	1	Don't Care	Don't Care	Don't Care	Don't Care
0	1	1	1	Data In	Don't Care	Don't Care	Don't Care
1	0	1	1	Don't Care	Data In	Don't Care	Don't Care
0	0	1	1	Data In	Data In	Don't Care	Don't Care
1	1	0	1	Don't Care	Don't Care	Data In	Don't Care
0	1	0	1	Data In	Don't Care	Data In	Don't Care
1	0	0	1	Don't Care	Data In	Data In	Don't Care
0	0	0	1	Data In	Data In	Data In	Don't Care
1	1	1	0	Don't Care	Don't Care	Don't Care	Data In
0	1	1	0	Data In	Don't Care	Don't Care	Data In
1	0	1	0	Don't Care	Data In	Don't Care	Data In
0	0	1	0	Data In	Data In	Don't Care	Data In
1	1	0	0	Don't Care	Don't Care	Data In	Data In
0	1	0	0	Data In	Don't Care	Data In	Data In
1	0	0	0	Don't Care	Data In	Data In	Data In
0	0	0	0	Data In	Data In	Data In	Data In

**x18 Byte Write Enable ( $\overline{BWn}$ ) Truth Table**

$\overline{BW0}$	$\overline{BW1}$	D0–D8	D9–D17
1	1	Don't Care	Don't Care
0	1	Data In	Don't Care
1	0	Don't Care	Data In
0	0	Data In	Data In

## Absolute Maximum Ratings

(All voltages reference to  $V_{SS}$ )

Symbol	Description	Value	Unit
$V_{DD}$	Voltage on $V_{DD}$ Pins	-0.5 to 2.4	V
$V_{DDQ}$	Voltage in $V_{DDQ}$ Pins	-0.5 to $V_{DD}$	V
$V_{REF}$	Voltage in $V_{REF}$ Pins	-0.5 to $V_{DDQ}$	V
$V_{I/O}$	Voltage on I/O Pins	-0.5 to $V_{DDQ} + 0.5$ ( $\leq 2.4$ V max.)	V
$V_{IN}$	Voltage on Other Input Pins	-0.5 to $V_{DDQ} + 0.5$ ( $\leq 2.4$ V max.)	V
$I_{IN}$	Input Current on Any Pin	+/-100	mA dc
$I_{OUT}$	Output Current on Any I/O Pin	+/-100	mA dc
$T_J$	Maximum Junction Temperature	120	$^{\circ}\text{C}$
$T_{STG}$	Storage Temperature	-55 to 125	$^{\circ}\text{C}$

### Note:

Permanent damage to the device may occur if the Absolute Maximum Ratings are exceeded. Operation should be restricted to Recommended Operating Conditions. Exposure to conditions exceeding the Recommended Operating Conditions, for an extended period of time, may affect reliability of this component.

## Recommended Operating Conditions

### Power Supplies

Parameter	Symbol	Min.	Typ.	Max.	Unit
Supply Voltage	$V_{DD}$	1.7	1.8	1.9	V
I/O Supply Voltage	$V_{DDQ}$	1.4	—	1.6	V
Reference Voltage	$V_{REF}$	$V_{DDQ}/2 - 0.05$	—	$V_{DDQ}/2 + 0.05$	V

### Note:

The power supplies need to be powered up simultaneously or in the following sequence:  $V_{DD}$ ,  $V_{DDQ}$ ,  $V_{REF}$ , followed by signal inputs. The power down sequence must be the reverse.  $V_{DDQ}$  must not exceed  $V_{DD}$ . For more information, read **AN1021 SigmaQuad and SigmaDDR Power-Up**.

### Operating Temperature

Parameter	Symbol	Min.	Typ.	Max.	Unit
Junction Temperature (Commercial Range Versions)	$T_J$	0	25	85	$^{\circ}\text{C}$
Junction Temperature (Industrial Range Versions)*	$T_J$	-40	25	100	$^{\circ}\text{C}$

### Note:

\* The part numbers of Industrial Temperature Range versions end with the character "I". Unless otherwise noted, all performance specifications quoted are evaluated for worst case in the temperature range marked on the device.

## Thermal Impedance

Package	Test PCB Substrate	$\theta_{JA}$ (C°/W) Airflow = 0 m/s	$\theta_{JA}$ (C°/W) Airflow = 1 m/s	$\theta_{JA}$ (C°/W) Airflow = 2 m/s	$\theta_{JB}$ (C°/W)	$\theta_{JC}$ (C°/W)
165 BGA	4-layer	15.25	12.38	11.41	4.79	1.31

### Notes:

1. Thermal Impedance data is based on a number of samples from multiple lots and should be viewed as a typical number.
2. Please refer to JEDEC standard JESD51-6.
3. The characteristics of the test fixture PCB influence reported thermal characteristics of the device. Be advised that a good thermal path to the PCB can result in cooling or heating of the RAM depending on PCB temperature.

## HSTL I/O DC Input Characteristics

Parameter	Symbol	Min	Max	Units	Notes
Input Reference Voltage	$V_{REF}$	$V_{DDQ}/2 - 0.05$	$V_{DDQ}/2 + 0.05$	V	—
Input High Voltage	$V_{IH1}$	$V_{REF} + 0.1$	$V_{DDQ} + 0.3$	V	1
Input Low Voltage	$V_{IL1}$	-0.3	$V_{REF} - 0.1$	V	1
Input High Voltage	$V_{IH2}$	$0.7 * V_{DDQ}$	$V_{DDQ} + 0.3$	V	2,3
Input Low Voltage	$V_{IL2}$	-0.3	$0.3 * V_{DDQ}$	V	2,3

### Notes:

1. Parameters apply to  $\overline{K}$ ,  $\overline{K}$ , SA, D,  $\overline{R}$ ,  $\overline{W}$ ,  $\overline{BW}$  during normal operation and JTAG boundary scan testing.
2. Parameters apply to  $\overline{Doff}$ , ODT during normal operation and JTAG boundary scan testing.
3. Parameters apply to ZQ during JTAG boundary scan testing only.

## HSTL I/O AC Input Characteristics

Parameter	Symbol	Min	Max	Units	Notes
Input Reference Voltage	$V_{REF}$	$V_{DDQ}/2 - 0.08$	$V_{DDQ}/2 + 0.08$	V	—
Input High Voltage	$V_{IH1}$	$V_{REF} + 0.2$	$V_{DDQ} + 0.5$	V	1,2,3
Input Low Voltage	$V_{IL1}$	-0.5	$V_{REF} - 0.2$	V	1,2,3
Input High Voltage	$V_{IH2}$	$V_{DDQ} - 0.2$	$V_{DDQ} + 0.5$	V	4,5
Input Low Voltage	$V_{IL2}$	-0.5	0.2	V	4,5

### Notes:

1.  $V_{IH(MAX)}$  and  $V_{IL(MIN)}$  apply for pulse widths less than one-quarter of the cycle time.
2. Input rise and fall times must be a minimum of 1 V/ns, and within 10% of each other.
3. Parameters apply to  $\overline{K}$ ,  $\overline{K}$ , SA, D,  $\overline{R}$ ,  $\overline{W}$ ,  $\overline{BW}$  during normal operation and JTAG boundary scan testing.
4. Parameters apply to  $\overline{Doff}$ , ODT during normal operation and JTAG boundary scan testing.

## Capacitance

( $T_A = 25^\circ\text{C}$ ,  $f = 1\text{ MHz}$ ,  $V_{DD} = 1.8\text{ V}$ )

Parameter	Symbol	Test conditions	Typ.	Max.	Unit
Input Capacitance	$C_{IN}$	$V_{IN} = 0\text{ V}$	4	5	pF
Output Capacitance	$C_{OUT}$	$V_{OUT} = 0\text{ V}$	4.5	5.5	pF

Note:

This parameter is sample tested.

## AC Test Conditions

Parameter	Conditions
Input high level	1.25 V
Input low level	0.25 V
Max. input slew rate	2 V/ns
Input reference level	0.75 V
Output reference level	$V_{DDQ}/2$

Note:

Test conditions as specified with output loading as shown unless otherwise noted.

## AC Test Load Diagram

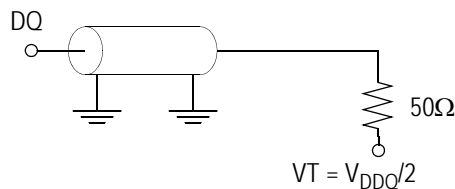

$$R_Q = 250\ \Omega \text{ (HSTL I/O)}$$

$$V_{REF} = 0.75\text{ V}$$

## Input and Output Leakage Characteristics

Parameter	Symbol	Test Conditions	Min.	Max
Input Leakage Current (except mode pins)	$I_{IL}$	$V_{IN} = 0\text{ to }V_{DDQ}$	-2 uA	2 uA
$\overline{\text{Doff}}$	$I_{IL\overline{\text{DOFF}}}$	$V_{IN} = 0\text{ to }V_{DDQ}$	-2uA	100 uA
ODT	$I_{IL\text{ ODT}}$	$V_{IN} = 0\text{ to }V_{DDQ}$	-2 uA	100 uA
Output Leakage Current	$I_{OL}$	Output Disable, $V_{OUT} = 0\text{ to }V_{DDQ}$	-2 uA	2 uA

**Programmable Impedance HSTL Output Driver DC Electrical Characteristics**

Parameter	Symbol	Min.	Max.	Units	Notes
Output High Voltage	$V_{OH1}$	$V_{DDQ}/2 - 0.12$	$V_{DDQ}/2 + 0.12$	V	1
Output Low Voltage	$V_{OL1}$	$V_{DDQ}/2 - 0.12$	$V_{DDQ}/2 + 0.12$	V	2
Output High Voltage	$V_{OH2}$	$V_{DDQ} - 0.2$	$V_{DDQ}$	V	3, 4
Output Low Voltage	$V_{OL2}$	$V_{SS}$	0.2	V	3, 5
Output Driver Impedance	$R_{OUT}$	$(RQ/5) * 0.88$	$(RQ/5) * 1.12$	$\Omega$	6, 7

**Notes:**

- $I_{OH} = (V_{DDQ}/2) / (RQ/5) \pm 15\%$  @  $V_{OH} = V_{DDQ}/2$  (for:  $175\Omega \leq RQ \leq 275\Omega$ )
- $I_{OL} = (V_{DDQ}/2) / (RQ/5) \pm 15\%$  @  $V_{OL} = V_{DDQ}/2$  (for:  $175\Omega \leq RQ \leq 275\Omega$ )
- $0\Omega \leq RQ \leq \infty\Omega$
- $I_{OH} = -1.0$  mA
- $I_{OL} = 1.0$  mA
- Parameter applies when  $175\Omega \leq RQ \leq 275\Omega$
- Tested at  $V_{OUT} = V_{DDQ} * 0.2$  and  $V_{DDQ} * 0.8$

**Operating Currents**

Parameter	Symbol	Test Conditions	-450		-400		-375		-333		-300		Notes
			0° to 70°C	-40° to 85°C	0° to 70°C	-40° to 85°C	0° to 70°C	-40° to 85°C	0° to 70°C	-40° to 85°C	0° to 70°C	-40° to 85°C	
Operating Current (x36): DDR	$I_{DD}$	$V_{DD} = \text{Max}, I_{OUT} = 0$ mA Cycle Time $\geq t_{KHKH}$ Min	2050 mA	2070 mA	1860 mA	1880 mA	1760 mA	1780 mA	1600 mA	1620 mA	1480 mA	1500 mA	2, 3
Operating Current (x18): DDR	$I_{DD}$	$V_{DD} = \text{Max}, I_{OUT} = 0$ mA Cycle Time $\geq t_{KHKH}$ Min	1490 mA	1510 mA	1360 mA	1380 mA	1300 mA	1320 mA	1190 mA	1210 mA	1100 mA	1120 mA	2, 3

**Notes:**

- Power measured with output pins floating.
- Minimum cycle,  $I_{OUT} = 0$  mA
- Operating current is calculated with 50% read cycles and 50% write cycles.

**AC Electrical Characteristics**

Parameter	Symbol	-450		-400		-375		-333		-300		Units	Notes
		Min	Max	Min	Max	Min	Max	Min	Max	Min	Max		
<b>Clock</b>													
K, $\bar{K}$ Clock Cycle Time	$t_{KHKH}$	2.2	6.0	2.5	6.0	2.66	6.0	3.0	6.0	3.3	6.0	ns	
tK Variable	$t_{KVar}$	—	0.15	—	0.2	—	0.2	—	0.2	—	0.2	ns	4
K, $\bar{K}$ Clock High Pulse Width	$t_{KHKL}$	0.4	—	0.4	—	0.4	—	0.4	—	0.4	—	cycle	
K, $\bar{K}$ Clock Low Pulse Width	$t_{KLKH}$	0.4	—	0.4	—	0.4	—	0.4	—	0.4	—	cycle	
K to $\bar{K}$ High	$t_{KH\bar{K}H}$	0.94	—	1.06	—	1.13	—	1.28	—	1.40	—	ns	
$\bar{K}$ to K High	$t_{\bar{K}HKH}$	0.94	—	1.06	—	1.13	—	1.28	—	1.40	—	ns	
DLL Lock Time	$t_{KLock}$	64K	—	64K	—	64K	—	64K	—	64K	—	cycle	5
K Static to DLL reset	$t_{KReset}$	30	—	30	—	30	—	30	—	30	—	ns	
<b>Output Times</b>													
K, $\bar{K}$ Clock High to Data Output Valid	$t_{KHQV}$	—	0.45	—	0.45	—	0.45	—	0.45	—	0.45	ns	
K, $\bar{K}$ Clock High to Data Output Hold	$t_{KHQX}$	-0.45	—	-0.45	—	-0.45	—	-0.45	—	-0.45	—	ns	
K, $\bar{K}$ Clock High to Echo Clock Valid	$t_{KHCOV}$	—	0.45	—	0.45	—	0.45	—	0.45	—	0.45	ns	
K, $\bar{K}$ Clock High to Echo Clock Hold	$t_{KHCOX}$	-0.45	—	-0.45	—	-0.45	—	-0.45	—	-0.45	—	ns	
CQ, $\bar{CQ}$ High Output Valid	$t_{COHQV}$	—	0.15	—	0.2	—	0.2	—	0.2	—	0.2	ns	
CQ, $\bar{CQ}$ High Output Hold	$t_{COHQX}$	-0.15	—	-0.2	—	-0.2	—	-0.2	—	-0.2	—	ns	
CQ, $\bar{CQ}$ High to QVLD	$t_{QVLD}$	-0.15	0.15	-0.2	0.2	-0.2	0.2	-0.2	0.2	-0.2	0.2	ns	
CQ Phase Distortion	$t_{COH\bar{C}QH}$ $t_{\bar{C}QHCOH}$	0.85	—	1.0	—	1.08	—	1.25	—	1.40	—	ns	
K Clock High to Data Output High-Z	$t_{KHQZ}$	—	0.45	—	0.45	—	0.45	—	0.45	—	0.45	ns	
K Clock High to Data Output Low-Z	$t_{KHQX1}$	-0.45	—	-0.45	—	-0.45	—	-0.45	—	-0.45	—	ns	
<b>Setup Times</b>													
Address Input Setup Time	$t_{AVKH}$	0.275	—	0.28	—	0.28	—	0.28	—	0.28	—	ns	1
Control Input Setup Time (R, W)	$t_{IVKH}$	0.275	—	0.28	—	0.28	—	0.28	—	0.28	—	ns	2
Control Input Setup Time (BW <sub>X</sub> )	$t_{IVKH}$	0.22	—	0.28	—	0.28	—	0.28	—	0.28	—	ns	3
Data Input Setup Time	$t_{DVKH}$	0.22	—	0.28	—	0.28	—	0.28	—	0.28	—	ns	
<b>Hold Times</b>													
Address Input Hold Time	$t_{KHAX}$	0.275	—	0.28	—	0.28	—	0.28	—	0.28	—	ns	1
Control Input Hold Time (R, W)	$t_{KHIX}$	0.275	—	0.28	—	0.28	—	0.28	—	0.28	—	ns	2
Control Input Hold Time (BW <sub>X</sub> )	$t_{KHIX}$	0.22	—	0.28	—	0.28	—	0.28	—	0.28	—	ns	3
Data Input Hold Time	$t_{KHDX}$	0.22	—	0.28	—	0.28	—	0.28	—	0.28	—	ns	

**Notes:**

1. All Address inputs must meet the specified setup and hold times for all latching clock edges.
2. Control signals are R, W.
3. Control signals are BW<sub>0</sub>, BW<sub>1</sub> and (BW<sub>2</sub>, BW<sub>3</sub> for x36).
4. Clock phase jitter is the variance from clock rising edge to the next expected clock rising edge.
5. V<sub>DD</sub> slew rate must be less than 0.1 V DC per 50 ns for DLL lock retention. DLL lock time begins once V<sub>DD</sub> and input clock are stable.

### Read NOP CQ-Based Timing Diagram

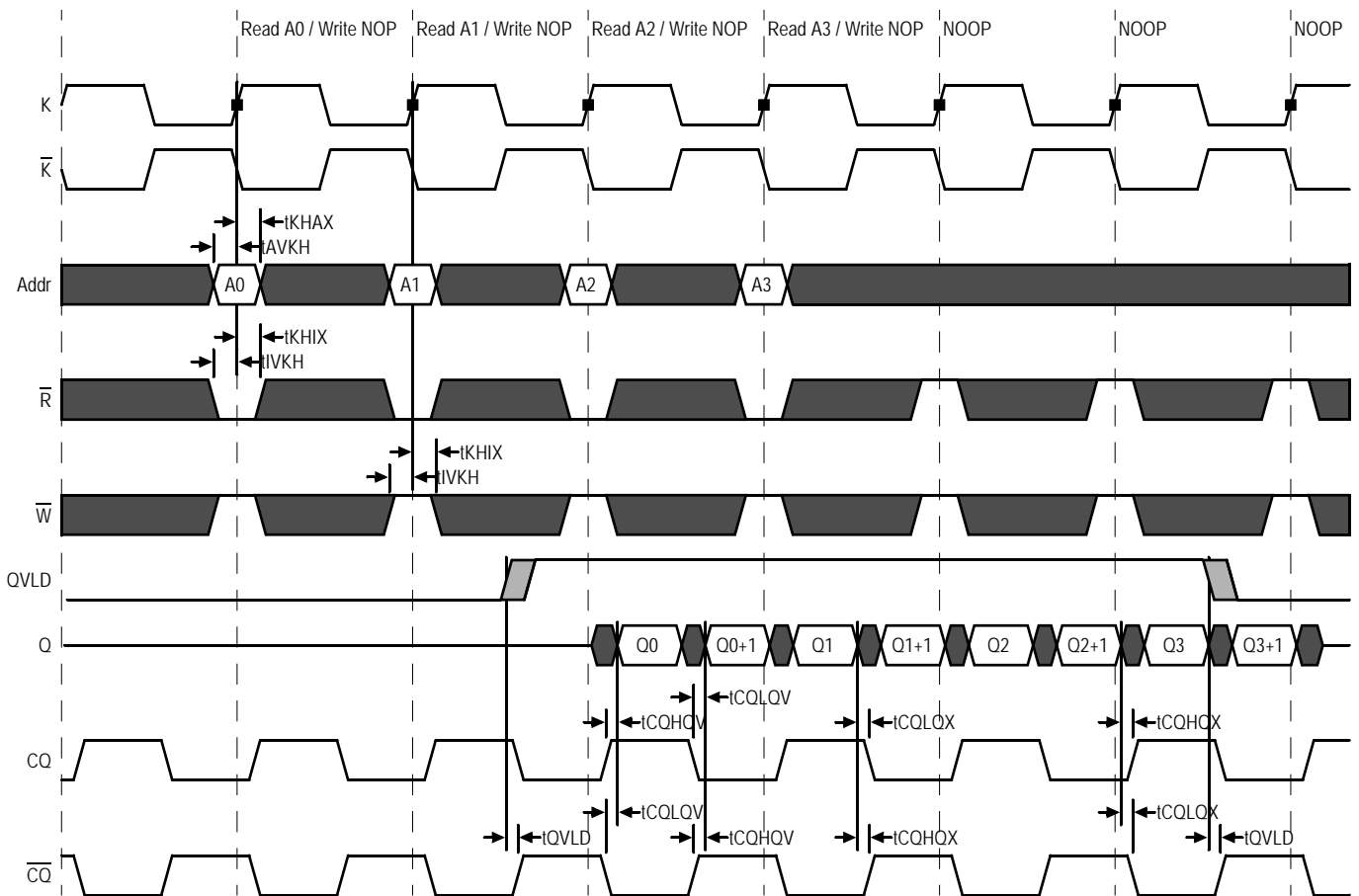



### Read-Write CQ-Based Timing Diagram

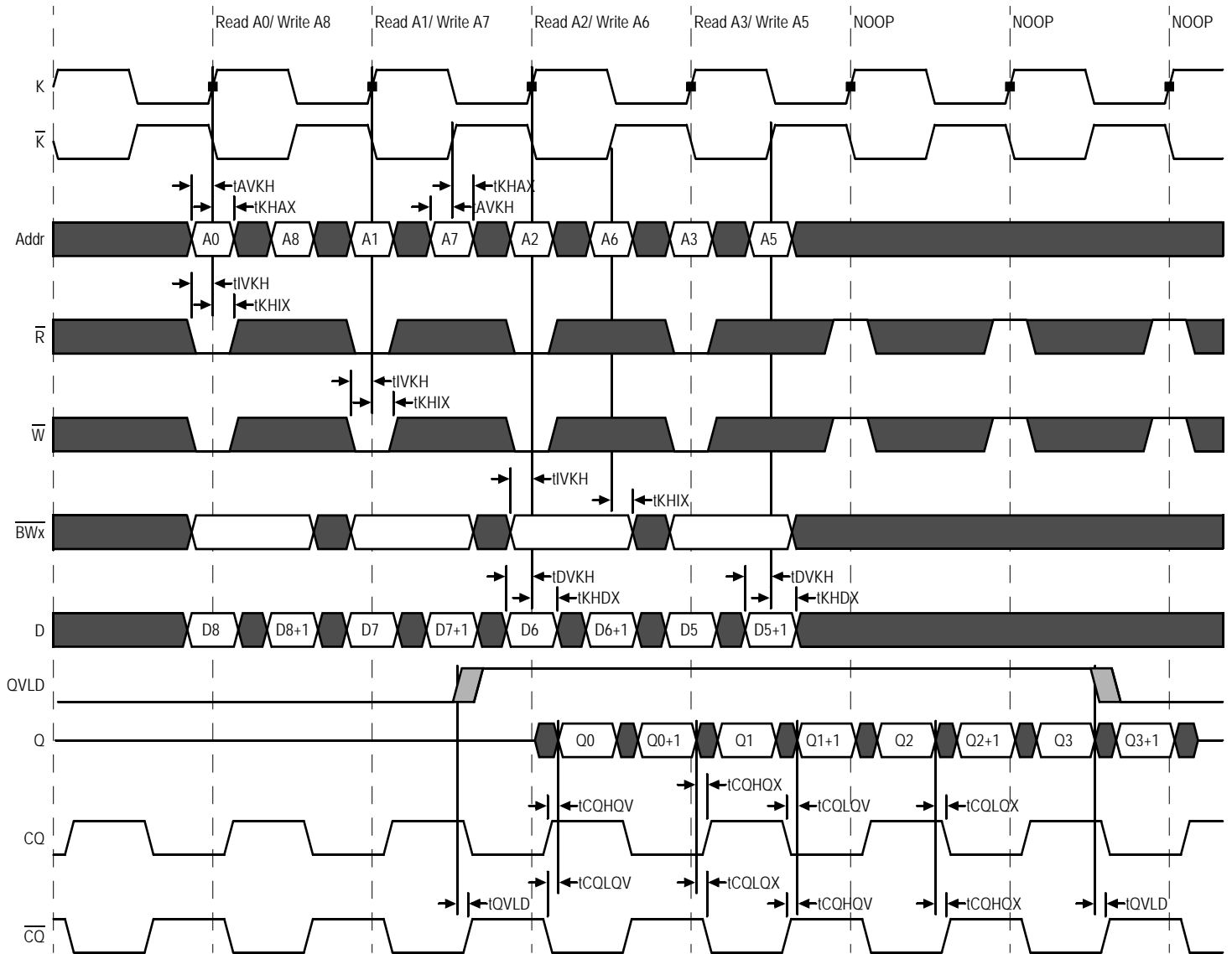

### Write NOP Timing Diagram

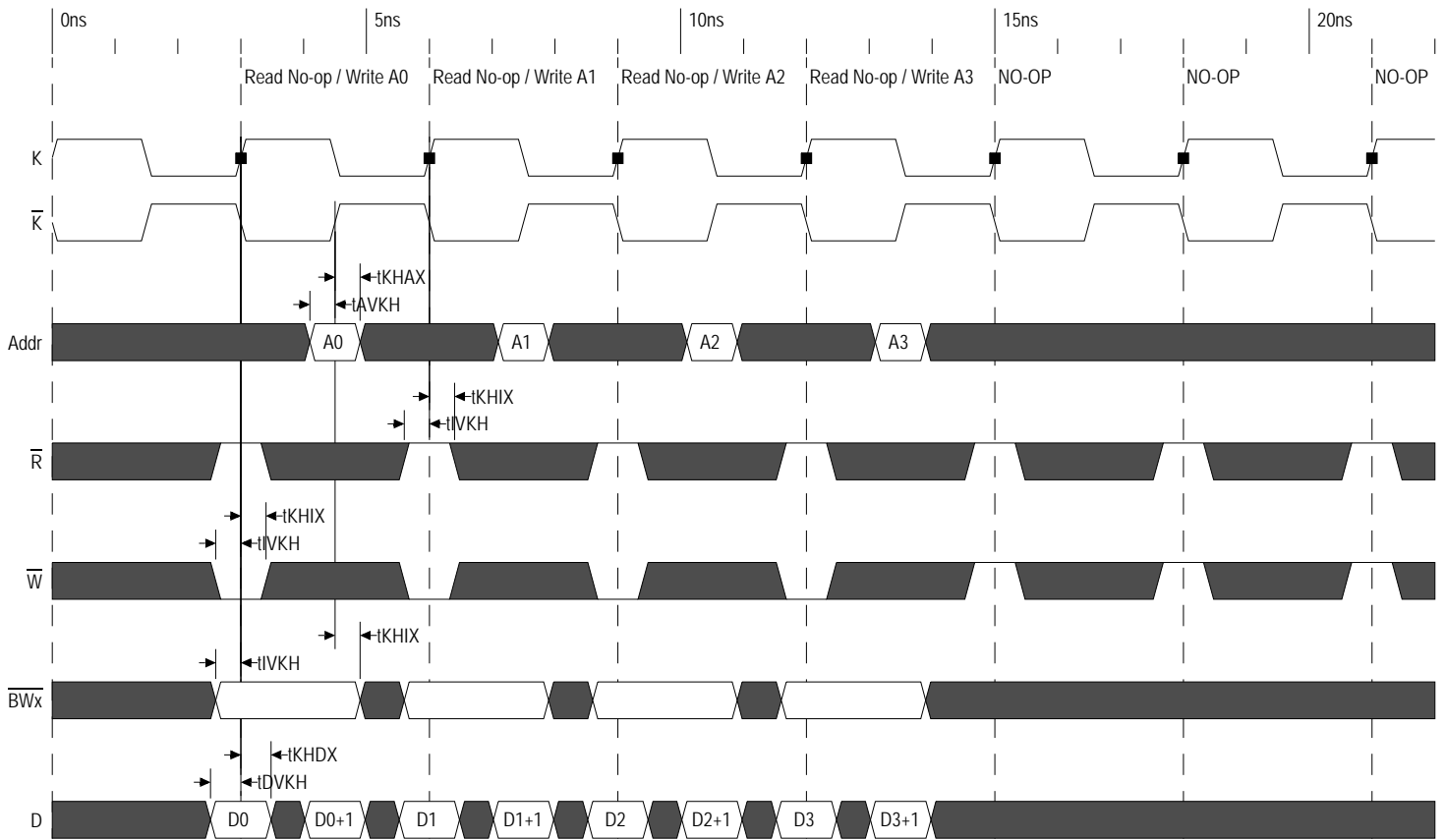

## JTAG Port Operation

### Overview

The JTAG Port on this RAM operates in a manner that is compliant with IEEE Standard 1149.1-1990, a serial boundary scan interface standard (commonly referred to as JTAG). The JTAG Port input interface levels scale with  $V_{DD}$ . The JTAG output drivers are powered by  $V_{DD}$ .

### Disabling the JTAG Port

It is possible to use this device without utilizing the JTAG port. The port is reset at power-up and will remain inactive unless clocked. TCK, TDI, and TMS are designed with internal pull-up circuits. To assure normal operation of the RAM with the JTAG Port unused, TCK, TDI, and TMS may be left floating or tied to either  $V_{DD}$  or  $V_{SS}$ . TDO should be left unconnected.

## JTAG Pin Descriptions

Pin	Pin Name	I/O	Description
TCK	Test Clock	In	Clocks all TAP events. All inputs are captured on the rising edge of TCK and all outputs propagate from the falling edge of TCK.
TMS	Test Mode Select	In	The TMS input is sampled on the rising edge of TCK. This is the command input for the TAP controller state machine. An undriven TMS input will produce the same result as a logic one input level.
TDI	Test Data In	In	The TDI input is sampled on the rising edge of TCK. This is the input side of the serial registers placed between TDI and TDO. The register placed between TDI and TDO is determined by the state of the TAP Controller state machine and the instruction that is currently loaded in the TAP Instruction Register (refer to the TAP Controller State Diagram). An undriven TDI pin will produce the same result as a logic one input level.
TDO	Test Data Out	Out	Output that is active depending on the state of the TAP state machine. Output changes in response to the falling edge of TCK. This is the output side of the serial registers placed between TDI and TDO.

### Note:

This device does not have a TRST (TAP Reset) pin. TRST is optional in IEEE 1149.1. The Test-Logic-Reset state is entered while TMS is held high for five rising edges of TCK. The TAP Controller is also reset automatically at power-up.

## JTAG Port Registers

### Overview

The various JTAG registers, referred to as Test Access Port or TAP Registers, are selected (one at a time) via the sequences of 1s and 0s applied to TMS as TCK is strobed. Each of the TAP Registers is a serial shift register that captures serial input data on the rising edge of TCK and pushes serial data out on the next falling edge of TCK. When a register is selected, it is placed between the TDI and TDO pins.

### Instruction Register

The Instruction Register holds the instructions that are executed by the TAP controller when it is moved into the Run, Test/Idle, or the various data register states. Instructions are 3 bits long. The Instruction Register can be loaded when it is placed between the TDI and TDO pins. The Instruction Register is automatically preloaded with the IDCODE instruction at power-up or whenever the controller is placed in Test-Logic-Reset state.

### Bypass Register

The Bypass Register is a single bit register that can be placed between TDI and TDO. It allows serial test data to be passed through the RAM's JTAG Port to another device in the scan chain with as little delay as possible.

### Boundary Scan Register

The Boundary Scan Register is a collection of flip flops that can be preset by the logic level found on the RAM's input or I/O pins. The flip flops are then daisy chained together so the levels found can be shifted serially out of the JTAG Port's TDO pin. The Boundary Scan Register also includes a number of place holder flip flops (always set to a logic 1). The relationship between the device pins and the bits in the Boundary Scan Register is described in the Scan Order Table following. The Boundary Scan

Register, under the control of the TAP Controller, is loaded with the contents of the RAMs I/O ring when the controller is in Capture-DR state and then is placed between the TDI and TDO pins when the controller is moved to Shift-DR state. SAMPLE-Z, SAMPLE/PRELOAD and EXTEST instructions can be used to activate the Boundary Scan Register.

### JTAG TAP Block Diagram



#### Identification (ID) Register

The ID Register is a 32-bit register that is loaded with a device and vendor specific 32-bit code when the controller is put in Capture-DR state with the IDCODE command loaded in the Instruction Register. The code is loaded from a 32-bit on-chip ROM. It describes various attributes of the RAM as indicated below. The register is then placed between the TDI and TDO pins when the controller is moved into Shift-DR state. Bit 0 in the register is the LSB and the first to reach TDO when shifting begins.

#### ID Register Contents

See BSDL Model																GSI Technology JEDEC Vendor ID Code						Presence Register										
Bit #	31	30	29	28	27	26	25	24	23	22	21	20	19	18	17	16	15	14	13	12	11	10	9	8	7	6	5	4	3	2	1	0
	X	X	X	X	X	X	X	X	X	X	X	X	X	X	X	X	X	X	X	X	0	0	0	1	1	0	1	1	0	0	1	1

## Tap Controller Instruction Set

### Overview

There are two classes of instructions defined in the Standard 1149.1-1990; the standard (Public) instructions, and device specific (Private) instructions. Some Public instructions are mandatory for 1149.1 compliance. Optional Public instructions must be implemented in prescribed ways. The TAP on this device may be used to monitor all input and I/O pads, and can be used to load address, data or control signals into the RAM or to preload the I/O buffers.

When the TAP controller is placed in Capture-IR state the two least significant bits of the instruction register are loaded with 01. When the controller is moved to the Shift-IR state the Instruction Register is placed between TDI and TDO. In this state the desired instruction is serially loaded through the TDI input (while the previous contents are shifted out at TDO). For all instructions, the TAP executes newly loaded instructions only when the controller is moved to Update-IR state. The TAP instruction set for this device is listed in the following table.

JTAG Tap Controller State Diagram

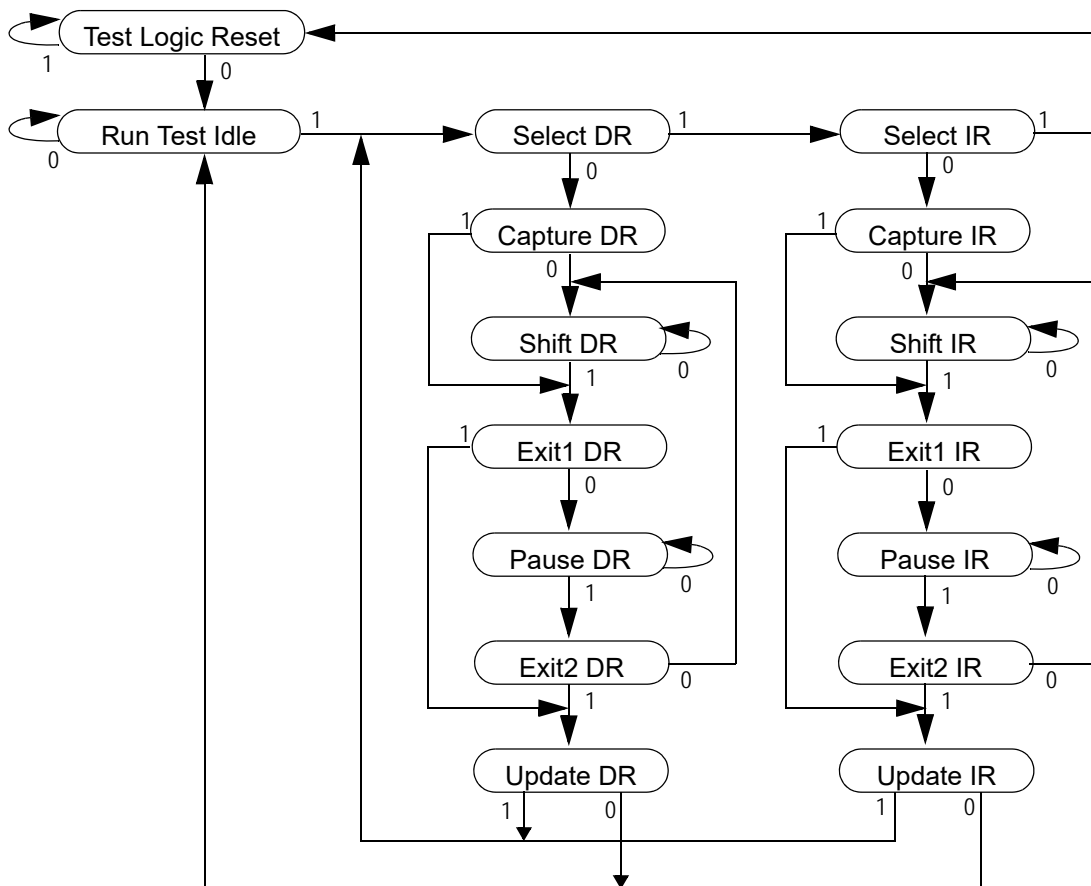

### Instruction Descriptions

#### BYPASS

When the BYPASS instruction is loaded in the Instruction Register the Bypass Register is placed between TDI and TDO. This occurs when the TAP controller is moved to the Shift-DR state. This allows the board level scan path to be shortened to facilitate testing of other devices in the scan path.

#### SAMPLE/PRELOAD

SAMPLE/PRELOAD is a Standard 1149.1 mandatory public instruction. When the SAMPLE / PRELOAD instruction is

loaded in the Instruction Register, moving the TAP controller into the Capture-DR state loads the data in the RAMs input and I/O buffers into the Boundary Scan Register. Boundary Scan Register locations are not associated with an input or I/O pin, and are loaded with the default state identified in the Boundary Scan Chain table at the end of this section of the datasheet. Because the RAM clock is independent from the TAP Clock (TCK) it is possible for the TAP to attempt to capture the I/O ring contents while the input buffers are in transition (i.e. in a metastable state). Although allowing the TAP to sample metastable inputs will not harm the device, repeatable results cannot be expected. RAM input signals must be stabilized for long enough to meet the TAPs input data capture set-up plus hold time ( $t_{TS}$  plus  $t_{TH}$ ). The RAMs clock inputs need not be paused for any other TAP operation except capturing the I/O ring contents into the Boundary Scan Register. Moving the controller to Shift-DR state then places the boundary scan register between the TDI and TDO pins.

#### EXTEST

EXTEST is an IEEE 1149.1 mandatory public instruction. It is to be executed whenever the instruction register is loaded with all logic 0s. The EXTEST command does not block or override the RAM's input pins; therefore, the RAM's internal state is still determined by its input pins.

Typically, the Boundary Scan Register is loaded with the desired pattern of data with the SAMPLE/PRELOAD command. Then the EXTEST command is used to output the Boundary Scan Register's contents, in parallel, on the RAM's data output drivers on the falling edge of TCK when the controller is in the Update-IR state.

Alternately, the Boundary Scan Register may be loaded in parallel using the EXTEST command. When the EXTEST instruction is selected, the state of all the RAM's input and I/O pins, as well as the default values at Scan Register locations not associated with a pin, are transferred in parallel into the Boundary Scan Register on the rising edge of TCK in the Capture-DR state, the RAM's output pins drive out the value of the Boundary Scan Register location with which each output pin is associated.

#### IDCODE

The IDCODE instruction causes the ID ROM to be loaded into the ID register when the controller is in Capture-DR mode and places the ID register between the TDI and TDO pins in Shift-DR mode. The IDCODE instruction is the default instruction loaded in at power up and any time the controller is placed in the Test-Logic-Reset state.

#### SAMPLE-Z

If the SAMPLE-Z instruction is loaded in the instruction register, all RAM outputs are forced to an inactive drive state (high-Z) and the Boundary Scan Register is connected between TDI and TDO when the TAP controller is moved to the Shift-DR state.

## JTAG TAP Instruction Set Summary

Instruction	Code	Description	Notes
EXTEST	000	Places the Boundary Scan Register between TDI and TDO.	1
IDCODE	001	Preloads ID Register and places it between TDI and TDO.	1, 2
SAMPLE-Z	010	Captures I/O ring contents. Places the Boundary Scan Register between TDI and TDO. Forces all RAM output drivers to High-Z except CQ.	1
GSI	011	GSI private instruction.	1
SAMPLE/PRELOAD	100	Captures I/O ring contents. Places the Boundary Scan Register between TDI and TDO.	1
GSI	101	GSI private instruction.	1
GSI	110	GSI private instruction.	1
BYPASS	111	Places Bypass Register between TDI and TDO.	1

### Notes:

1. Instruction codes expressed in binary, MSB on left, LSB on right.
2. Default instruction automatically loaded at power-up and in test-logic-reset state.

## JTAG Port Recommended Operating Conditions and DC Characteristics

Parameter	Symbol	Min.	Max.	Unit	Notes
Test Port Input Low Voltage	$V_{ILJ}$	-0.3	$0.3 * V_{DD}$	V	1
Test Port Input High Voltage	$V_{IHJ}$	$0.7 * V_{DD}$	$V_{DD} + 0.3$	V	1
TMS, TCK and TDI Input Leakage Current	$I_{INHJ}$	-300	1	uA	2
TMS, TCK and TDI Input Leakage Current	$I_{INLJ}$	-1	100	uA	3
TDO Output Leakage Current	$I_{OLJ}$	-1	1	uA	4
Test Port Output High Voltage	$V_{OHJ}$	$V_{DD} - 0.2$	—	V	5, 6
Test Port Output Low Voltage	$V_{OLJ}$	—	0.2	V	5, 7
Test Port Output CMOS High	$V_{OHJC}$	$V_{DD} - 0.1$	—	V	5, 8
Test Port Output CMOS Low	$V_{OLJC}$	—	0.1	V	5, 9

### Notes:

1. Input Under/overshoot voltage must be  $-1\text{ V} < V_i < V_{DDn} + 1\text{ V}$  not to exceed 2.4 V maximum, with a pulse width not to exceed 20% tTKC.
2.  $V_{ILJ} \leq V_{IN} \leq V_{DDn}$
3.  $0\text{ V} \leq V_{IN} \leq V_{ILJn}$
4. Output Disable,  $V_{OUT} = 0$  to  $V_{DDn}$
5. The TDO output driver is served by the  $V_{DD}$  supply.
6.  $I_{OHJ} = -2\text{ mA}$
7.  $I_{OLJ} = +2\text{ mA}$
8.  $I_{OHJC} = -100\text{ uA}$
9.  $I_{OLJC} = +100\text{ uA}$

### JTAG Port AC Test Conditions

Parameter	Conditions
Input high level	$V_{DD} - 0.2 V$
Input low level	$0.2 V$
Input slew rate	$1 V/ns$
Input reference level	$V_{DD}/2$
Output reference level	$V_{DD}/2$

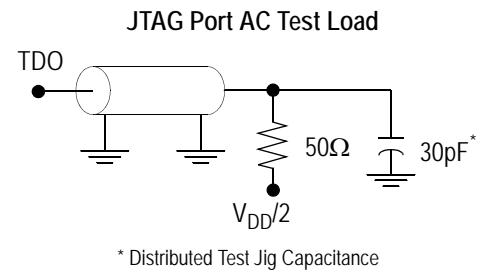

#### Notes:

1. Include scope and jig capacitance.
2. Test conditions as shown unless otherwise noted.

### JTAG Port Timing Diagram



### JTAG Port AC Electrical Characteristics

Parameter	Symbol	Min	Max	Unit
TCK Cycle Time	tTKC	50	—	ns
TCK Low to TDO Valid	tTKQ	—	20	ns
TCK High Pulse Width	tTKH	20	—	ns
TCK Low Pulse Width	tTKL	20	—	ns
TDI & TMS Set Up Time	tTS	10	—	ns
TDI & TMS Hold Time	tTH	10	—	ns



Package Dimensions—165-Bump FPBGA (Package E)

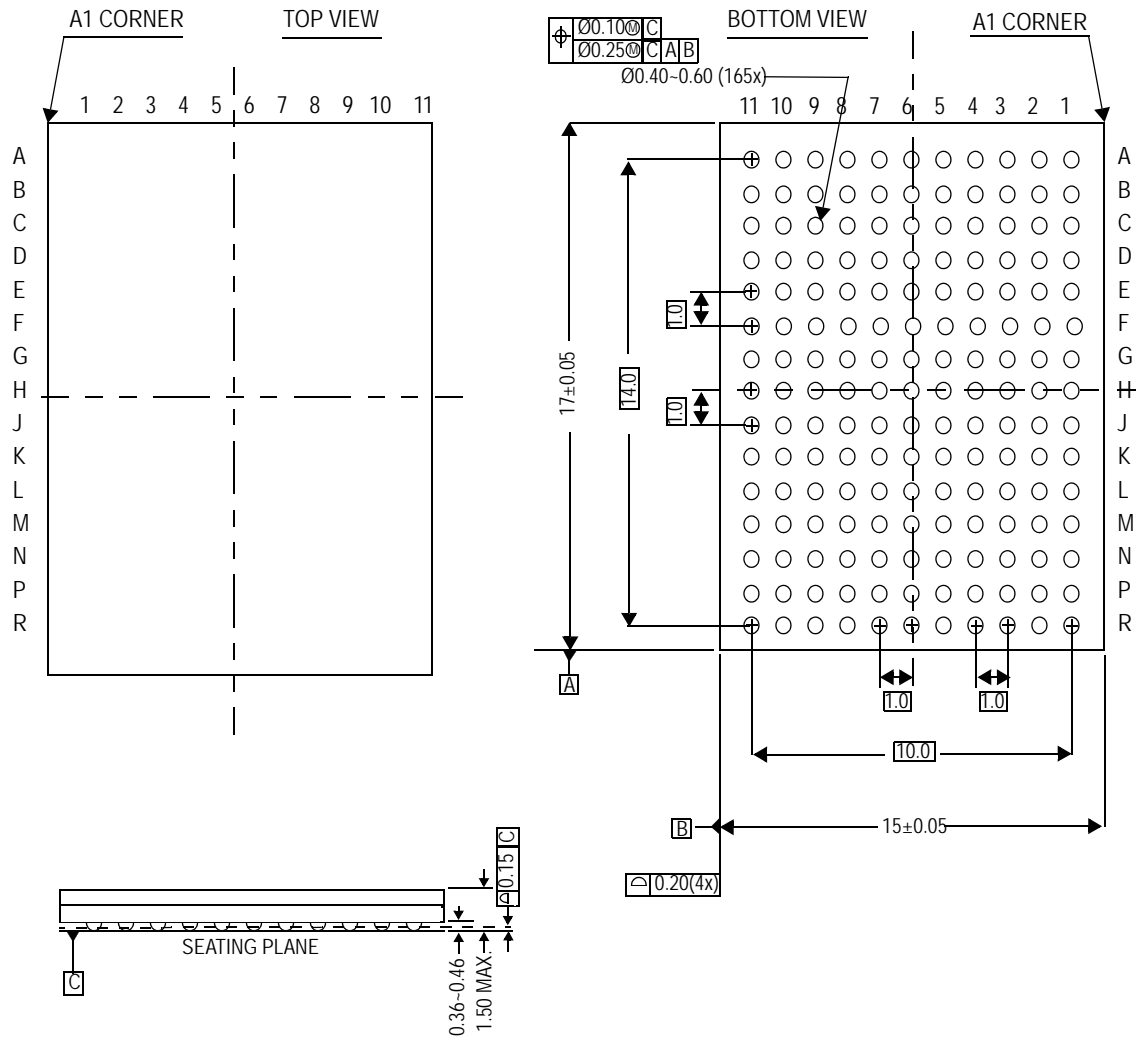

**Ordering Information—GSI SigmaQuad-II+ ECCRAM**

Org	Part Number <sup>1</sup>	Type	Package	Speed (MHz)	T <sub>J</sub> <sup>2</sup>
4M x 18	GS8672Q19BE-450	SigmaQuad-II+ ECCRAM	165-bump BGA	450	C
4M x 18	GS8672Q19BE-400	SigmaQuad-II+ ECCRAM	165-bump BGA	400	C
4M x 18	GS8672Q19BE-375	SigmaQuad-II+ ECCRAM	165-bump BGA	375	C
4M x 18	GS8672Q19BE-333	SigmaQuad-II+ ECCRAM	165-bump BGA	333	C
4M x 18	GS8672Q19BE-300	SigmaQuad-II+ ECCRAM	165-bump BGA	300	C
4M x 18	GS8672Q19BE-450I	SigmaQuad-II+ ECCRAM	165-bump BGA	450	I
4M x 18	GS8672Q19BE-400I	SigmaQuad-II+ ECCRAM	165-bump BGA	400	I
4M x 18	GS8672Q19BE-375I	SigmaQuad-II+ ECCRAM	165-bump BGA	375	I
4M x 18	GS8672Q19BE-333I	SigmaQuad-II+ ECCRAM	165-bump BGA	333	I
4M x 18	GS8672Q19BE-300I	SigmaQuad-II+ ECCRAM	165-bump BGA	300	I
2M x 36	GS8672Q37BE-450	SigmaQuad-II+ ECCRAM	165-bump BGA	450	C
2M x 36	GS8672Q37BE-400	SigmaQuad-II+ ECCRAM	165-bump BGA	400	C
2M x 36	GS8672Q37BE-375	SigmaQuad-II+ ECCRAM	165-bump BGA	375	C
2M x 36	GS8672Q37BE-333	SigmaQuad-II+ ECCRAM	165-bump BGA	333	C
2M x 36	GS8672Q37BE-300	SigmaQuad-II+ ECCRAM	165-bump BGA	300	C
2M x 36	GS8672Q37BE-450I	SigmaQuad-II+ ECCRAM	165-bump BGA	450	I
2M x 36	GS8672Q37BE-400I	SigmaQuad-II+ ECCRAM	165-bump BGA	400	I
2M x 36	GS8672Q37BE-375I	SigmaQuad-II+ ECCRAM	165-bump BGA	375	I
2M x 36	GS8672Q37BE-333I	SigmaQuad-II+ ECCRAM	165-bump BGA	333	I
2M x 36	GS8672Q37BE-300I	SigmaQuad-II+ ECCRAM	165-bump BGA	300	I
4M x 18	GS8672Q19BGE-450	SigmaQuad-II+ ECCRAM	RoHS-compliant 165-bump BGA	450	C
4M x 18	GS8672Q19BGE-400	SigmaQuad-II+ ECCRAM	RoHS-compliant 165-bump BGA	400	C
4M x 18	GS8672Q19BGE-375	SigmaQuad-II+ ECCRAM	RoHS-compliant 165-bump BGA	375	C
4M x 18	GS8672Q19BGE-333	SigmaQuad-II+ ECCRAM	RoHS-compliant 165-bump BGA	333	C
4M x 18	GS8672Q19BGE-300	SigmaQuad-II+ ECCRAM	RoHS-compliant 165-bump BGA	300	C
4M x 18	GS8672Q19BGE-450I	SigmaQuad-II+ ECCRAM	RoHS-compliant 165-bump BGA	450	I
4M x 18	GS8672Q19BGE-400I	SigmaQuad-II+ ECCRAM	RoHS-compliant 165-bump BGA	400	I
4M x 18	GS8672Q19BGE-375I	SigmaQuad-II+ ECCRAM	RoHS-compliant 165-bump BGA	375	I
4M x 18	GS8672Q19BGE-333I	SigmaQuad-II+ ECCRAM	RoHS-compliant 165-bump BGA	333	I
4M x 18	GS8672Q19BGE-300I	SigmaQuad-II+ ECCRAM	RoHS-compliant 165-bump BGA	300	I
2M x 36	GS8672Q37BGE-450	SigmaQuad-II+ ECCRAM	RoHS-compliant 165-bump BGA	450	C
2M x 36	GS8672Q37BGE-400	SigmaQuad-II+ ECCRAM	RoHS-compliant 165-bump BGA	400	C

**Notes:**

- For Tape and Reel add the character "T" to the end of the part number. Example: GS8672Q37BE-300T.
- C = Commercial Temperature Range. I = Industrial Temperature Range.