



TAOGLAS®



Datasheet

Phoenix II

Part No:
GSA.8835.A.101111

Description:

5G/4G I-Bar Adhesive Mount Fully Waterproof Rated
Low Profile Wideband Antenna

Features:

5G/4G Adhesive Mount Antenna
600-6000MHz Wideband Operation
IP67 & IP68 Rated Enclosure
Dimensions: 105 x 30 x 7.9mm
Connector: SMA Male Straight
Cable: 1m of RG-174
RoHS & REACH Compliant

1. Introduction	3
2. Specifications	4
3. Antenna Characteristics	6
4. Radiation Patterns	8
5. Mechanical Drawing	25
6. Packaging	26
<hr/>	
Changelog	27

Taoglas makes no warranties based on the accuracy or completeness of the contents of this document and reserves the right to make changes to specifications and product descriptions at any time without notice. Taoglas reserves all rights to this document and the information contained herein. Reproduction, use or disclosure to third parties without express permission is strictly prohibited.



1. Introduction



The Taoglas GSA.8835 is a fully IP67/68 rated waterproof 5G/4G external adhesive mount antenna designed for use with all Cellular modules worldwide including new 5G bands. The GSA.8835 has been designed as a fully IP67 waterproof rated enclosure and with extended wideband cellular frequency range coverage of 600-6000MHz, the newly designed GSA.8835 is ready for use at all cellular bands across 5G/4G/3G/2G.

Typical Applications Include:

- Transportation
- Agriculture
- Autonomous Vehicles/Robotics

Providing excellent efficiency and gain, this low profile(7.9mm) antenna is ideal in areas where space is at a premium. The Phoenix II is fully IP67 rated, making it an ideal solution for outdoor applications. The GSA.8835 can be mounted on glass or plastic and comes with a strong 3M 1600T adhesive already adhered to the bottom side of the antenna for ease of installation.

The Cable length and connector type is fully customizable, for more information or installation instructions, please contact your regional Taoglas Customer Support Team.

2. Specifications

Electrical

Band	Frequency (MHz)	Efficiency (%)	Average Gain (dB)	Peak Gain (dBi)	Impedance	Polarization	Radiation Pattern	Max. input power
5GNR/4G Band 71	617-698	37.8	-4.22	0.95	50 Ω	Linear	Omni	2W
4G/3G Band 12,13,14,17,28,29	698-806	52.2	-2.82	2.44				
4G/3G Band 5,8,18,19,20,26,27	824-960	64.1	-1.93	2.59				
5GNR/4G Band 21,32,74,75,76	1427-1518	82.6	-0.83	3.25				
4G/3G Band 1,2,3,4,9,23,25,35,39,66	1710-2200	76.9	-1.14	4.12				
4G/3G Band 7,38,41	2490-2690	65.8	-1.82	3.78				
5GNR/4G Band 22,42,48,77,78	3300-3500	62.9	-2.01	3.79				
5GNR/4G Band 43,48,77,78	3500-4200	39.3	-4.06	3.70				
LTE5200/ Wi-Fi 5800	5150-5925	51.8	-2.86	2.81				

Mechanical

Dimensions	30*105*7.9mm
Casing	PC+ABS
Cable	RG-174, 1000mm
Connector	SMA Male Straight
Adhesive	3M 1600T
Weight	35g

Environmental

Ingress Protection	IP67 & IP68
Temperature Range	-40°C to 85°C
Humidity	Non-condensing 65°C 95% RH
Shock (Drop Test)	1m drop on concrete 6 axes
Cable Pull	8kgf

5G/4G Bands				
Band Number	5GNR / FR1 / LTE / LTE-Advanced / WCDMA / HSPA / HSPA+ / TD-SCDMA			
	Uplink		Downlink	Covered
B1	1920 to 1980		2110 to 2170	✓
B2	1850 to 1910		1930 to 1990	✓
B3	1710 to 1785		1805 to 1880	✓
B4	1710 to 1755		2110 to 2155	✓
B5	824 to 849		869 to 894	✓
B7	2500 to 2570		2620 to 2690	✓
B8	880 to 915		925 to 960	✓
B9*	1749.9 to 1784.9		1844.9 to 1879.9	✓
B11	1427.9 to 1447.9		1475.9 to 1495.9	✓
B12	699 to 716		729 to 746	✓
B13	777 to 787		746 to 756	✓
B14	788 to 798		758 to 768	✓
B17	704 to 716		734 to 746	✓
B18	815 to 830		860 to 875	✓
B19	830 to 845		875 to 890	✓
B20	832 to 862		791 to 821	✓
B21	1447.9 to 1462.9		1495.9 to 1510.9	✓
B22*	3410 to 3490		3510 to 3590	✓
B23*	2000 to 2020		2180 to 2200	✓
B24	1626.5 to 1660.5		1525 to 1559	✓
B25	1850 to 1915		1930 to 1995	✓
B26	814 to 849		859 to 894	✓
B27*	807 to 824		852 to 869	✓
B28	703 to 748		758 to 803	✓
B29		717 to 728		✓
B30	2305 to 2315		2350 to 2360	✓
B31	452.5 to 457.5		462.5 to 467.5	✗
B32		1452 to 1496		✓
B34		2010 to 2025		✓
B35		1850 to 1910		✓
B36		1930 to 1990		✓
B37		1910 to 1930		✓
B38		2570 to 2620		✓
B39		1880 to 1920		✓
B40		2300 to 2400		✓
B41		2496 to 2690		✓
B42		3400 to 3600		✓
B43		3600 to 3800		✓
B45		1447 to 1467		✓
B46		5150 to 5925		✓
B47		5855 to 5925		✓
B48		3550 to 3700		✓
B49		3550 to 3700		✓
B50		1432 to 1517		✓
B51		1427 to 1432		✓
B52		3300 to 3400		✓
B53		2483.5 to 2495		✓
B65	1920 to 2010		2110 to 2200	✓
B66	1710 to 1780		2110 to 2200	✓
B68	698 to 728		753 to 783	✓
B69		2570 to 2620		✓
B70	1695 to 1710		1995 to 2020	✓
B71	663 to 698		617 to 652	✓
B72	451 to 456		461 to 466	✗
B73	450 to 455		460 to 465	✗
B74	1427 to 1470		1475 to 1518	✓
B75		1432 to 1517		✓
B76		1427 to 1432		✓
B77		3300 to 4200		✓
B78		3300 to 3800		✓
B79		4400 to 5000		✓
B85	698 to 716		728 to 746	✓
B87	410 to 415		420 to 425	✗
B88	412 to 417		422 to 427	✗

* Covered Bands represent at least 20% efficiency

3. Antenna Characteristics

3.1 Return Loss

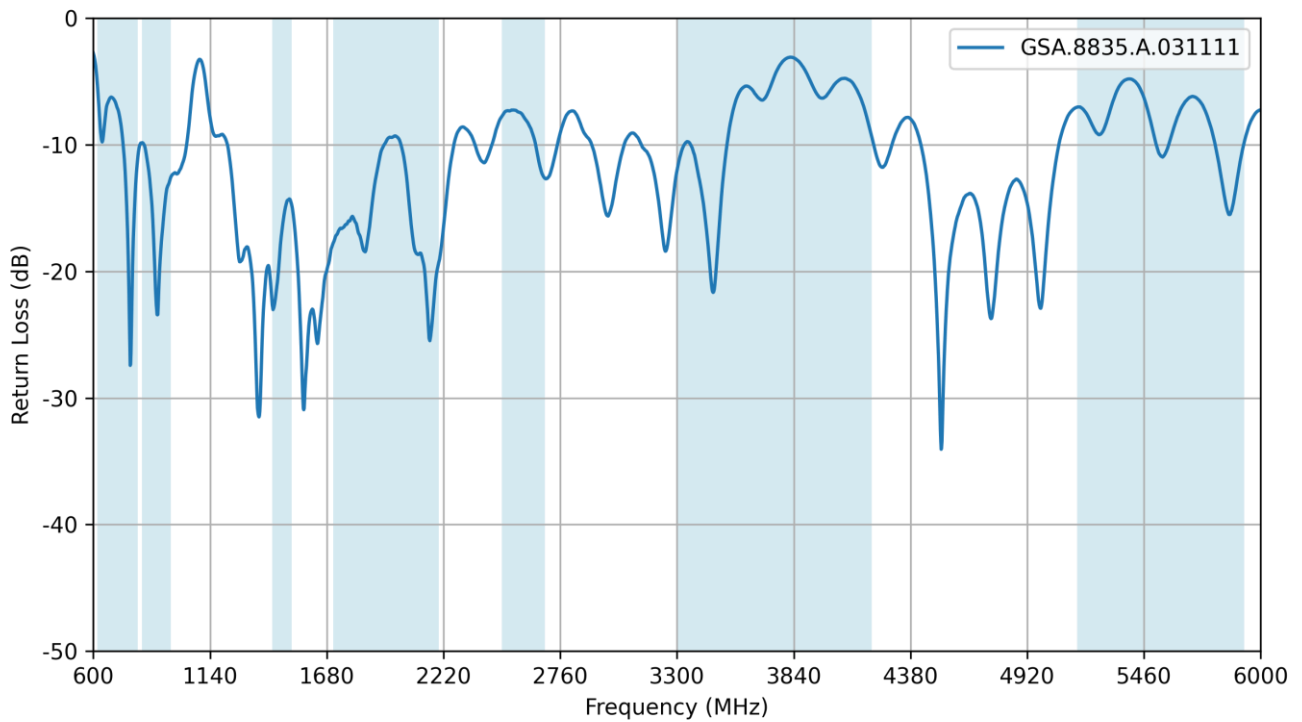

3.2 Efficiency

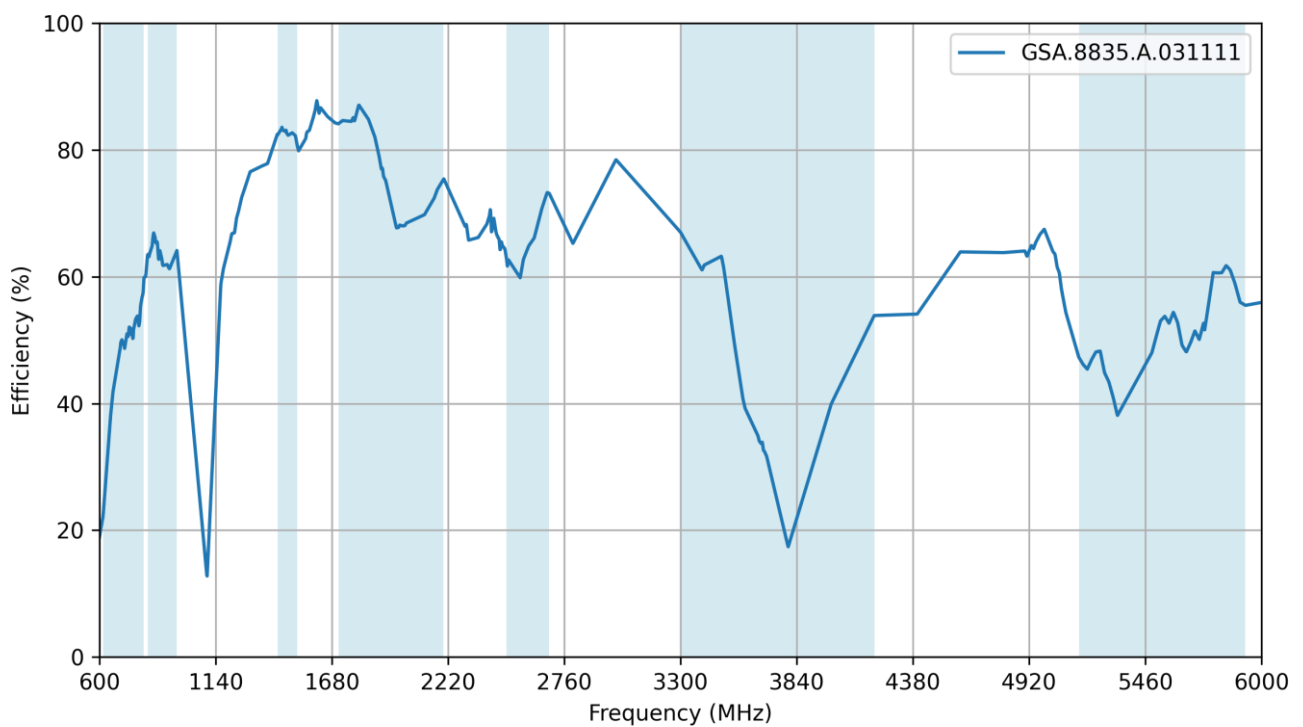

3.3 Average Gain

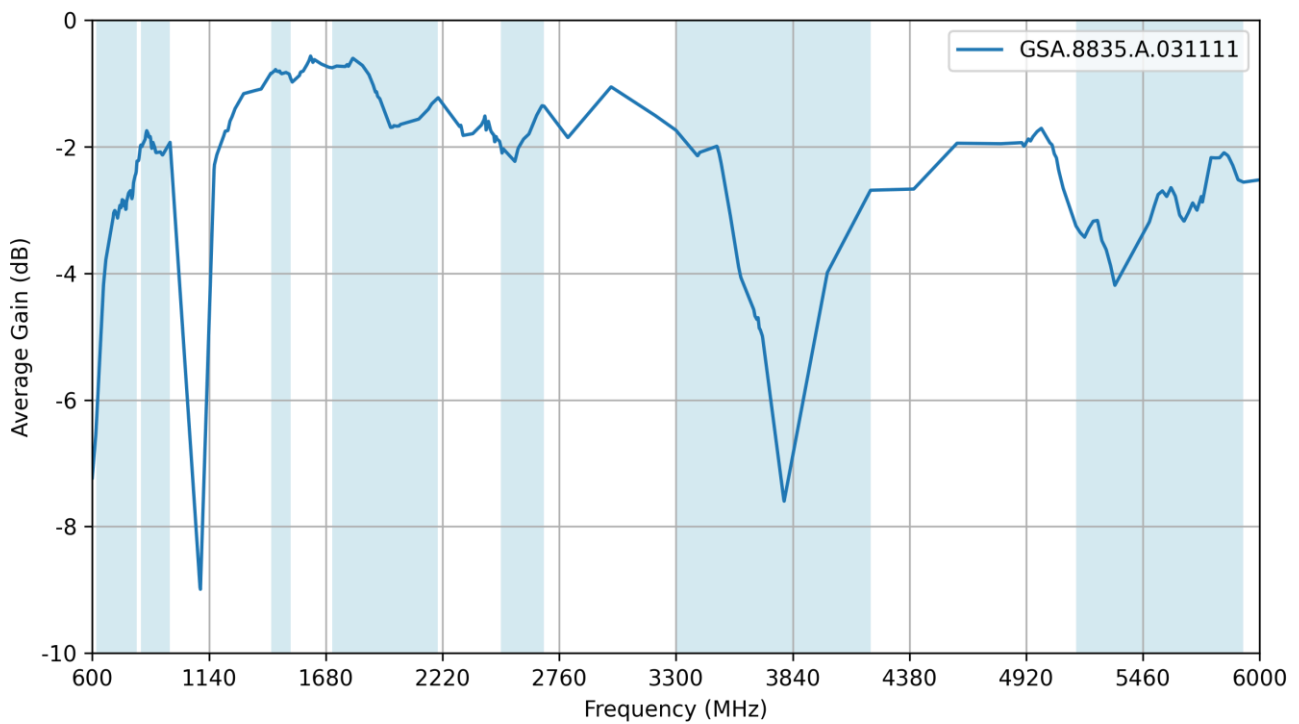

3.4 Peak Gain

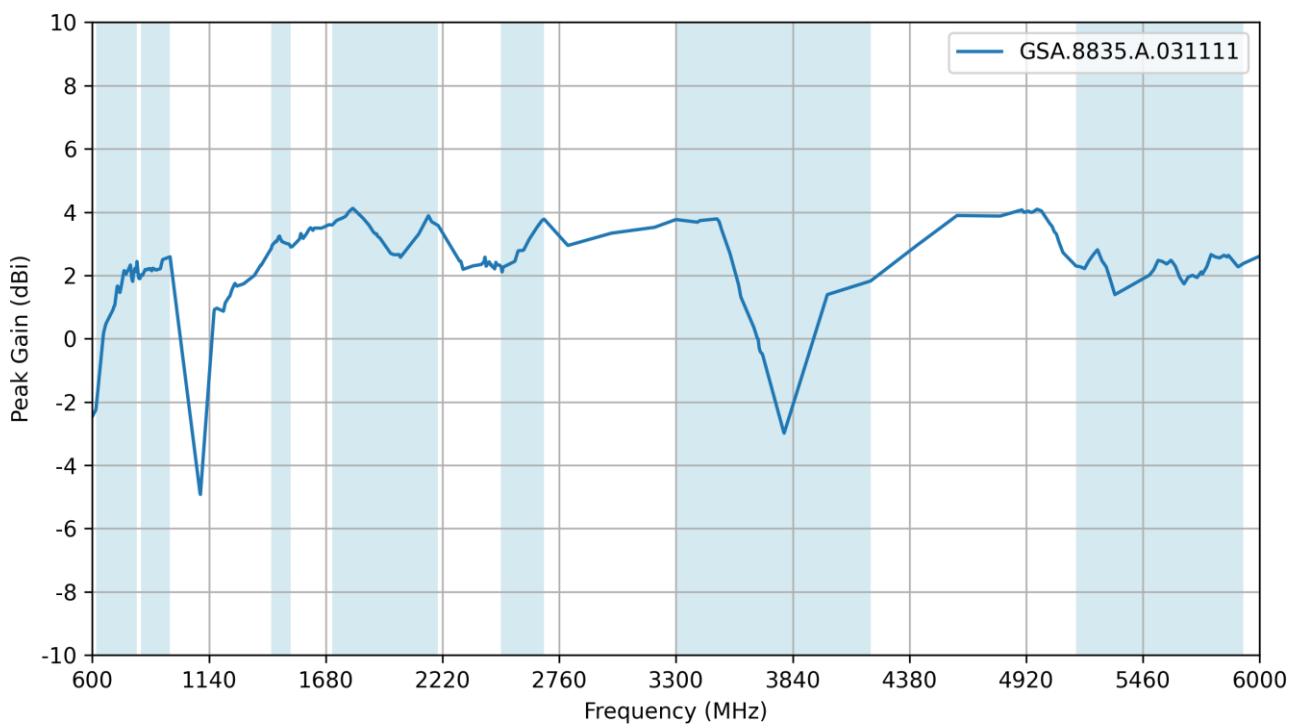

4. Radiation Patterns

4.1 Test Setup



Free space

4.2 3D and 2D Radiation Patterns

617MHz

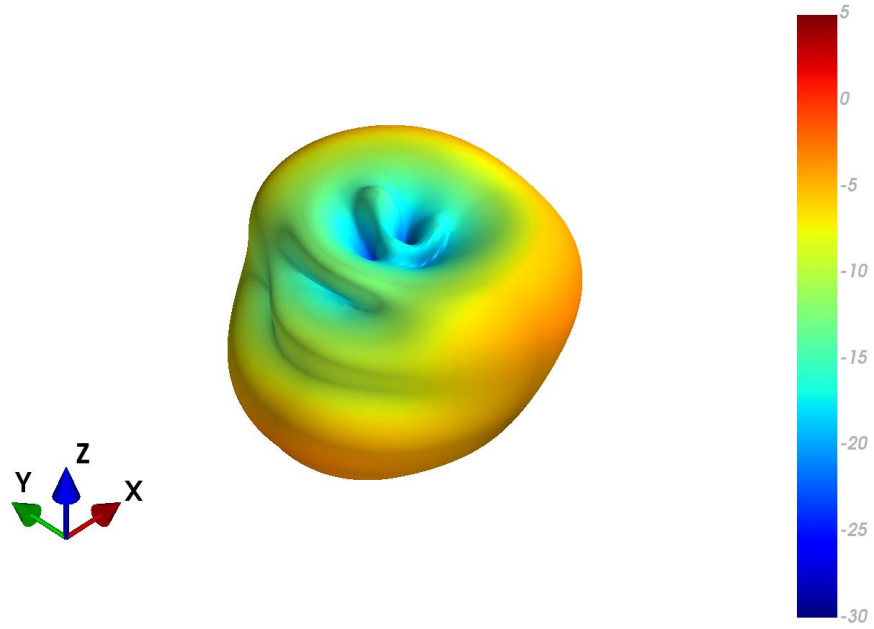

XZ Plane

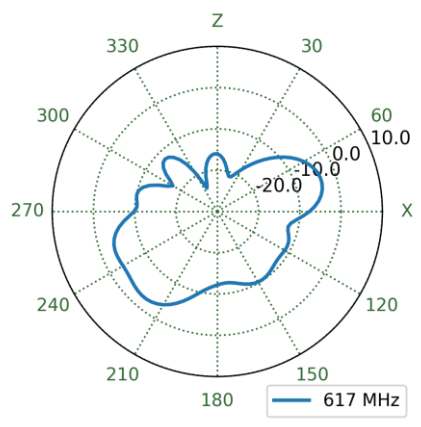

YZ Plane

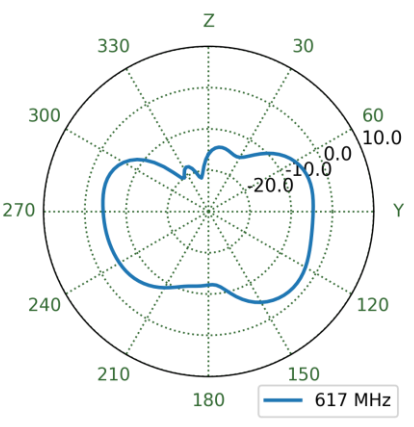

XY Plane

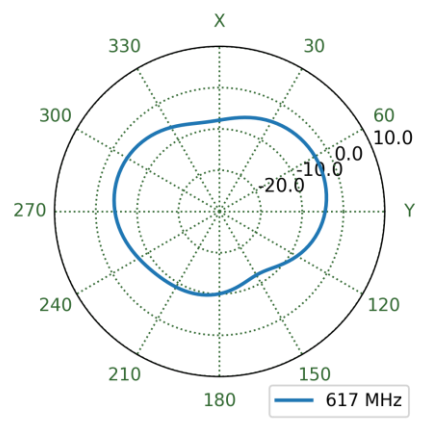

650MHz

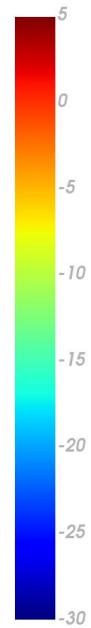
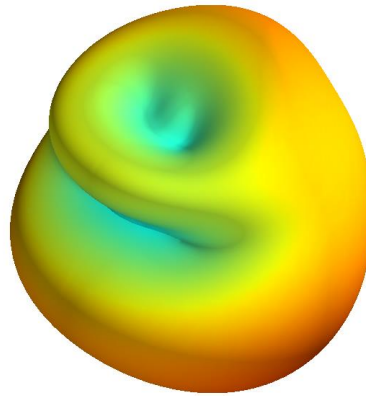
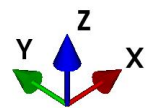

XZ Plane

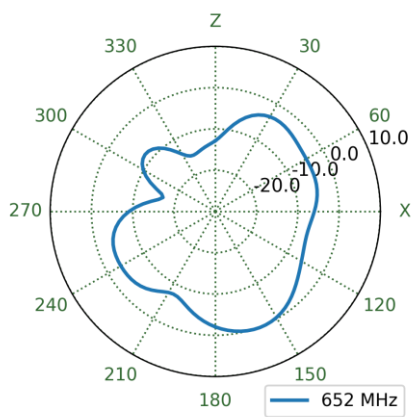

YZ Plane

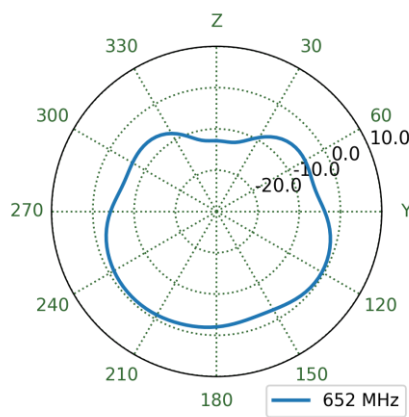

XY Plane

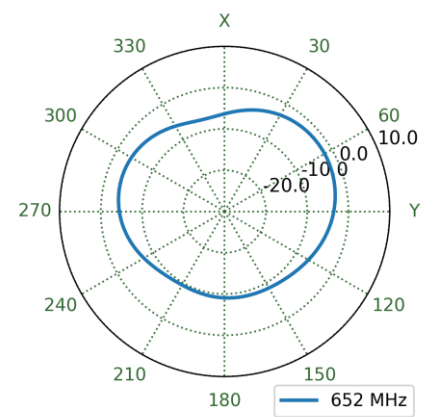

750MHz

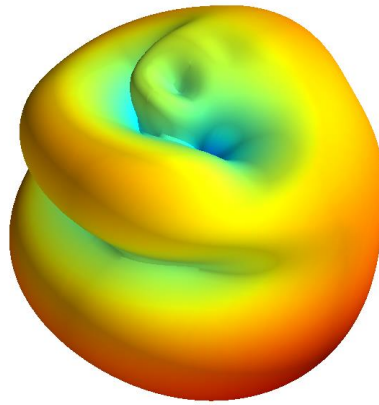
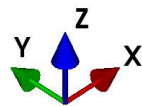

XZ Plane

YZ Plane

XY Plane

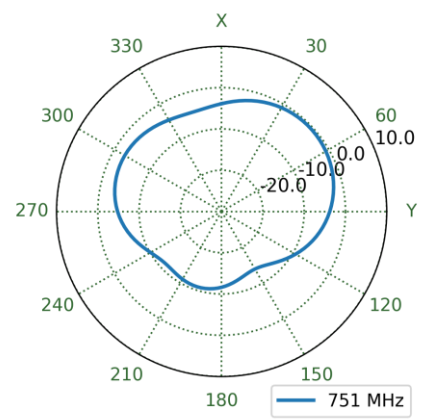
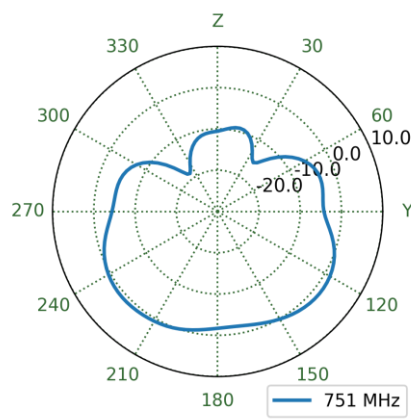
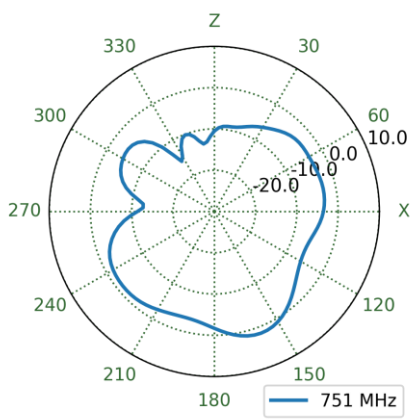

824MHz

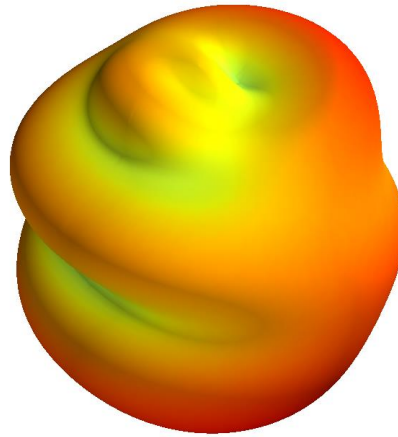
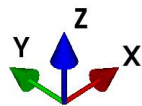

XZ Plane

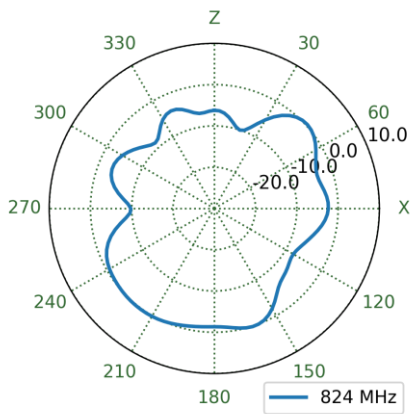

YZ Plane

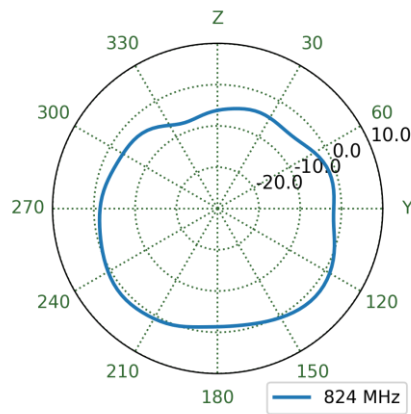

XY Plane

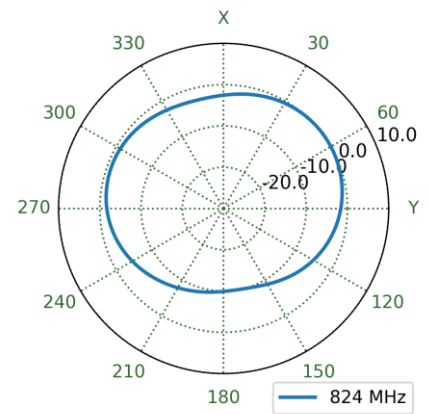

960MHz

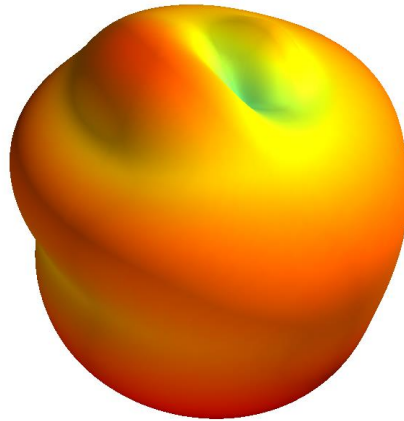
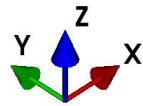

XZ Plane

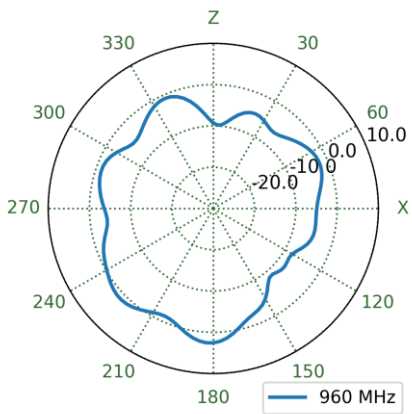

YZ Plane

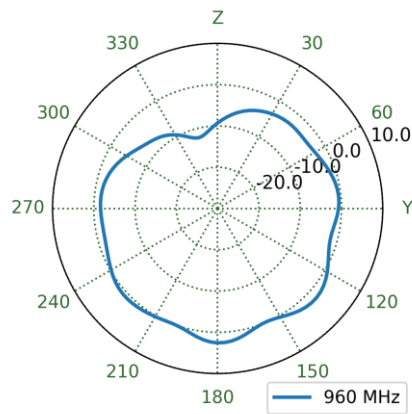

XY Plane

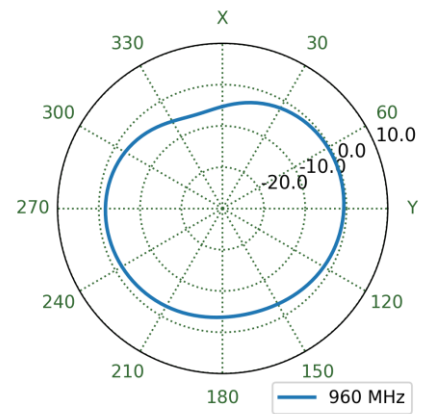

1710MHz

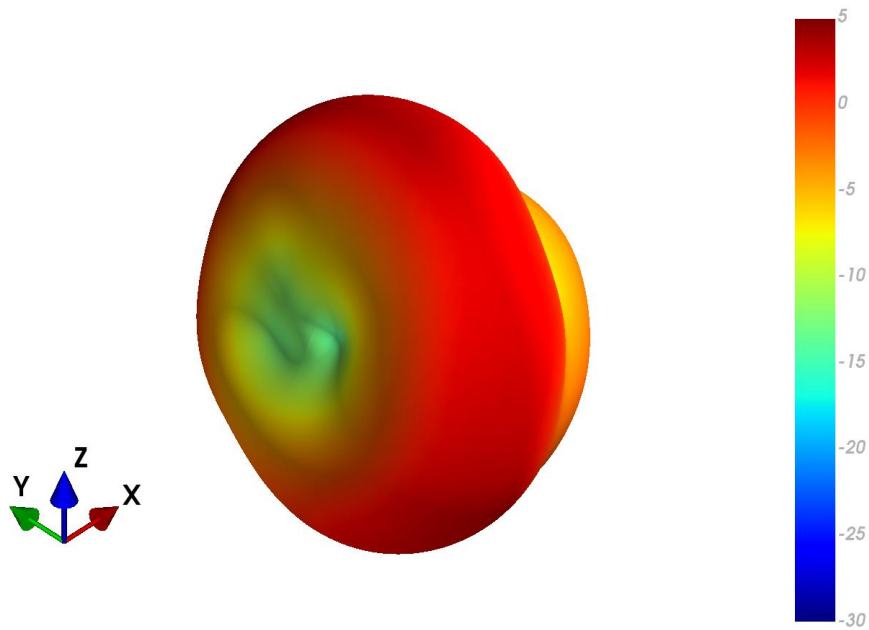

XZ Plane

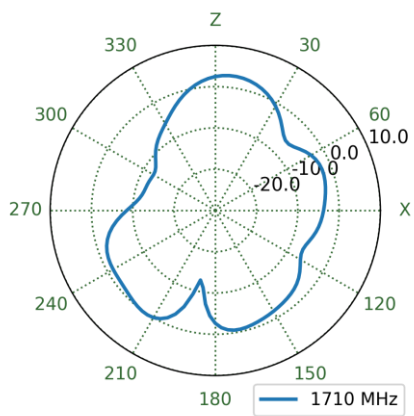

YZ Plane

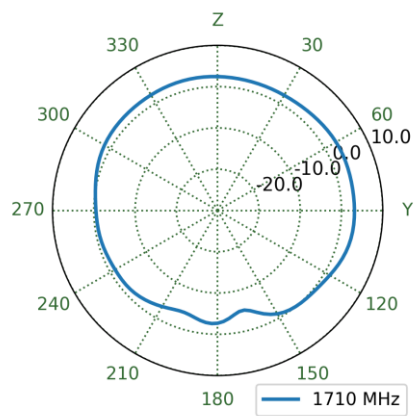

XY Plane

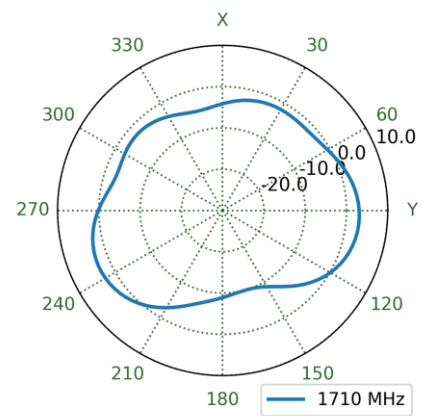

1950MHz

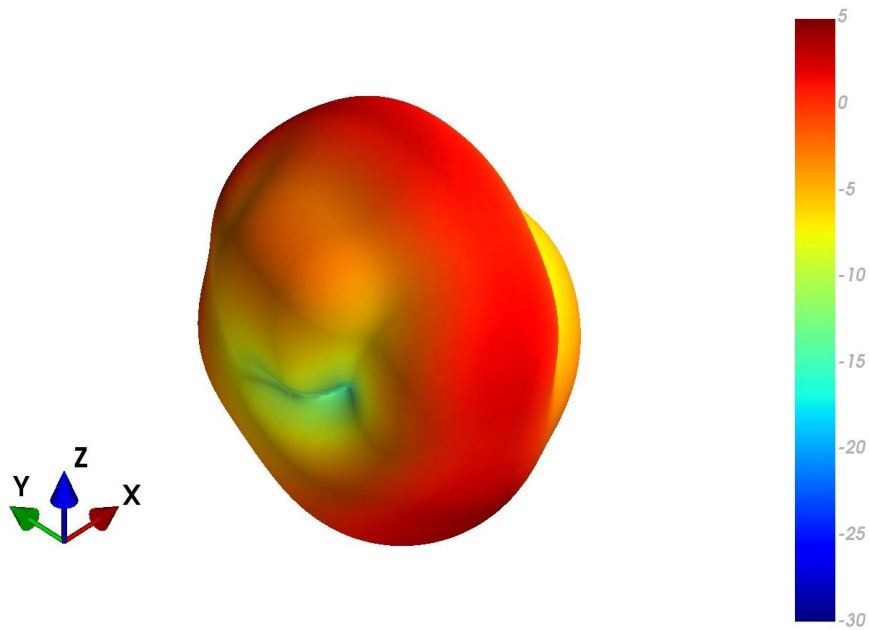

XZ Plane

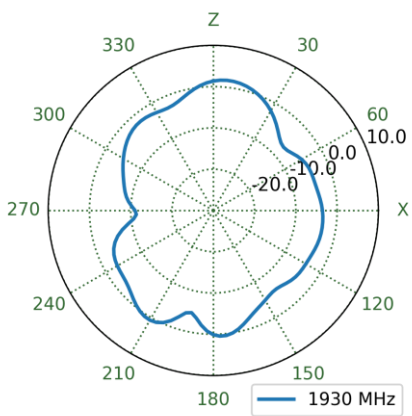

YZ Plane

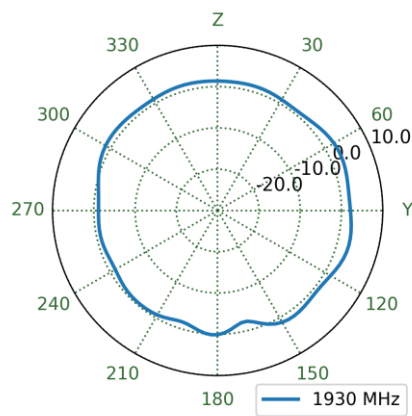

XY Plane

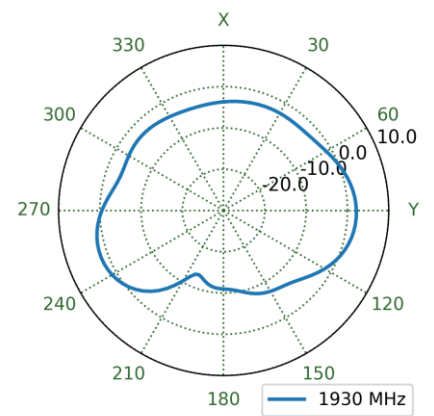

2200MHz

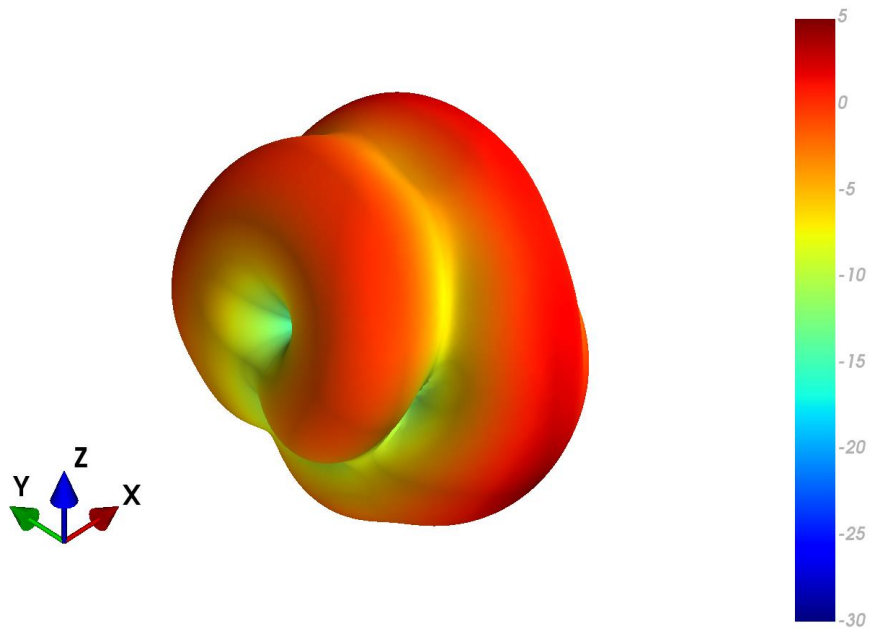

XZ Plane

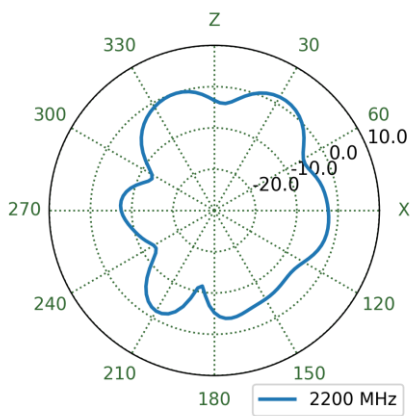

YZ Plane

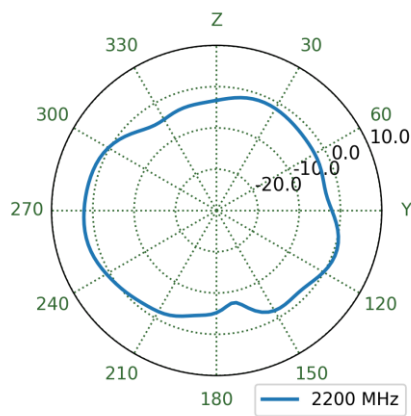

XY Plane

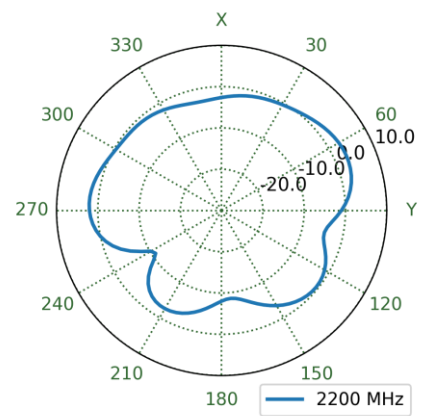

2500MHz

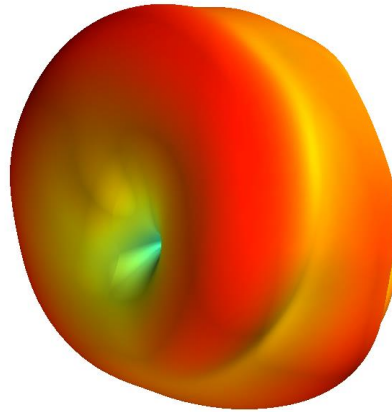
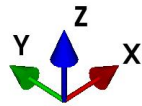

XZ Plane

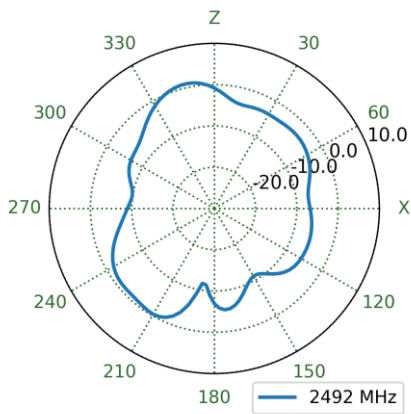

YZ Plane

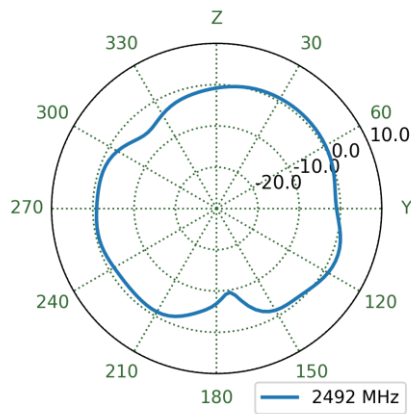

XY Plane

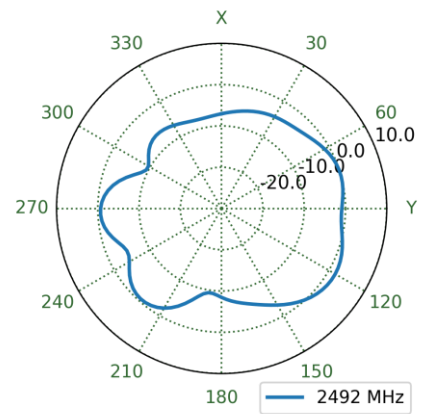

2690MHz

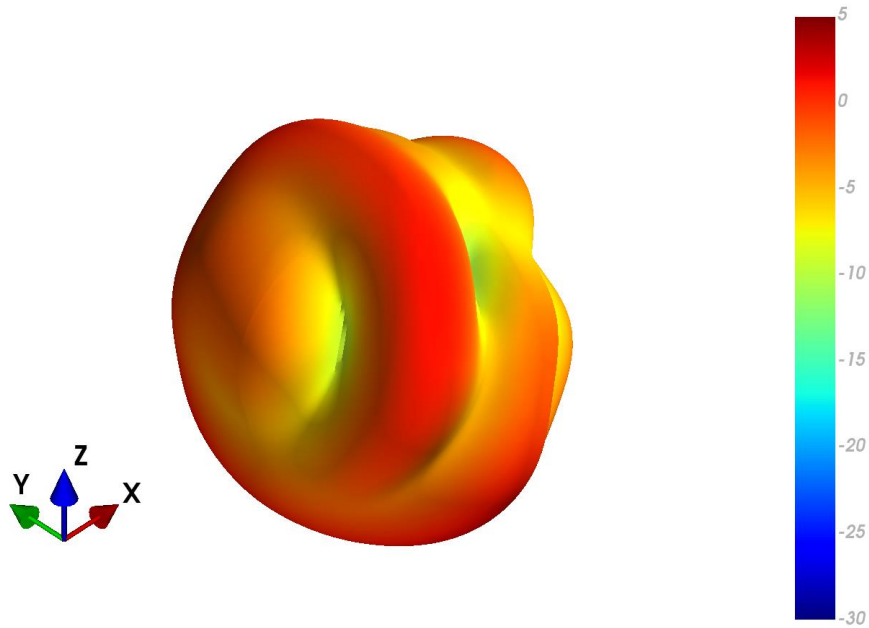

XZ Plane

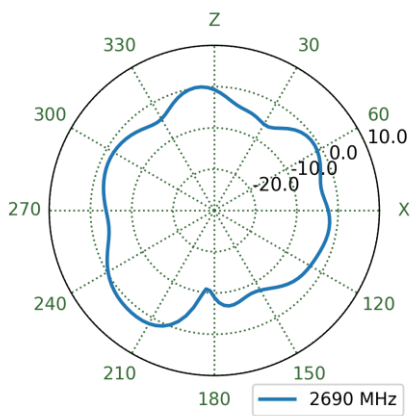

YZ Plane

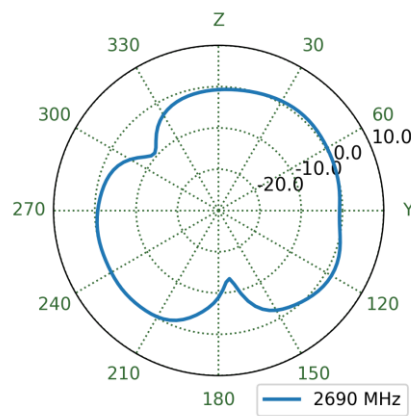

XY Plane

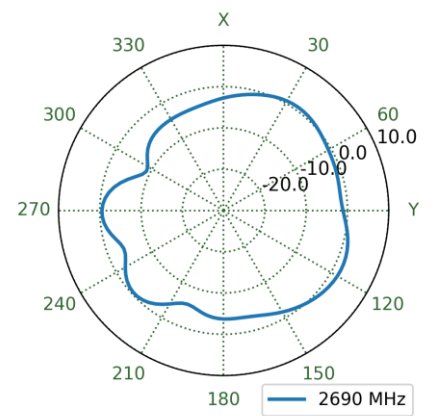

3300MHz

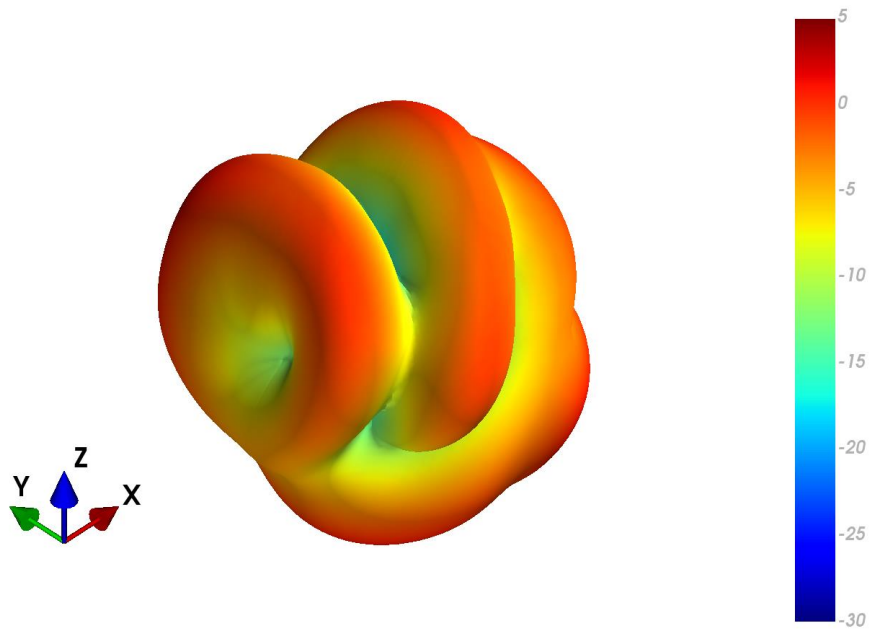

XZ Plane

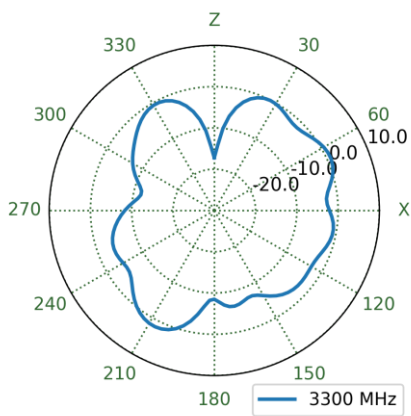

YZ Plane

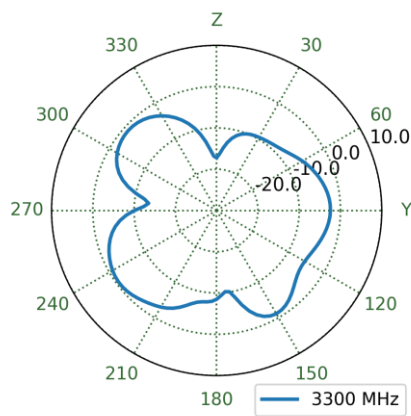

XY Plane

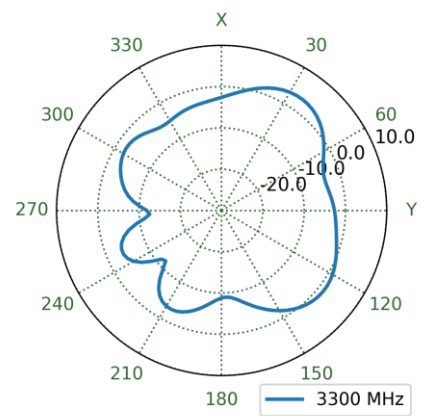

3500MHz

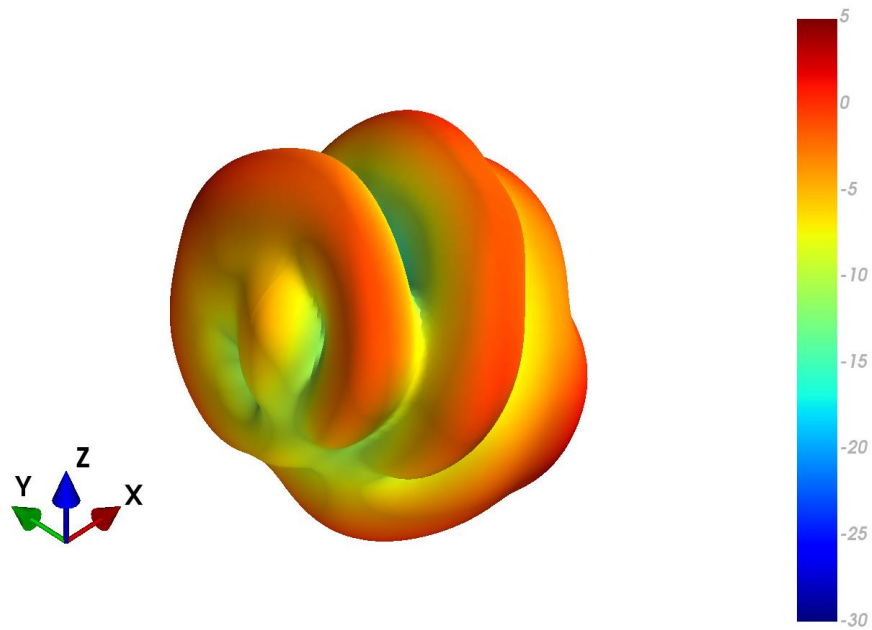

XZ Plane

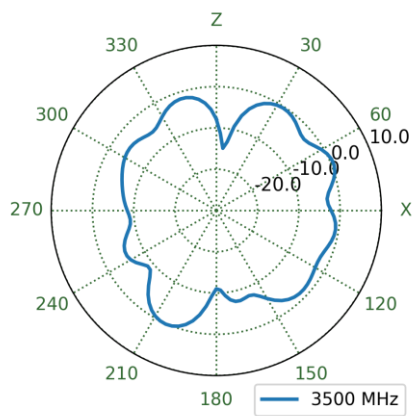

YZ Plane

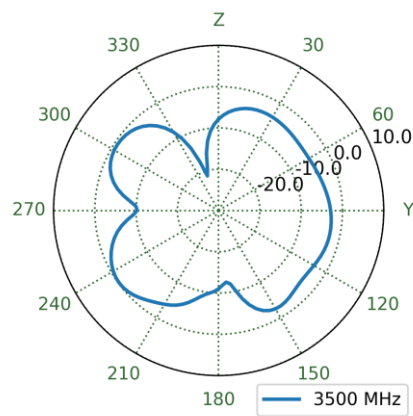

XY Plane

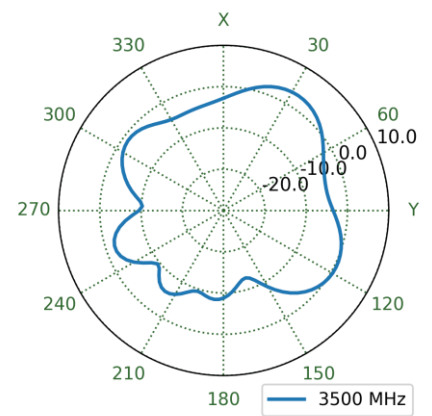

4200MHz

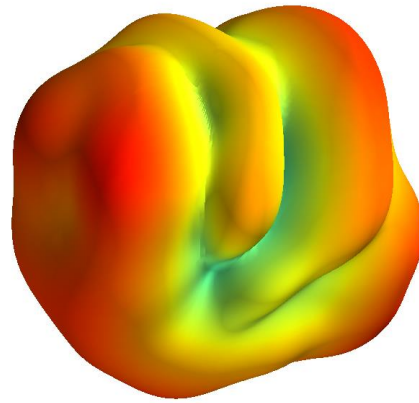
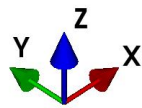

XZ Plane

YZ Plane

XY Plane

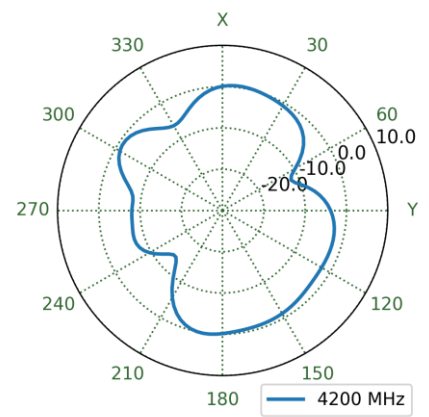
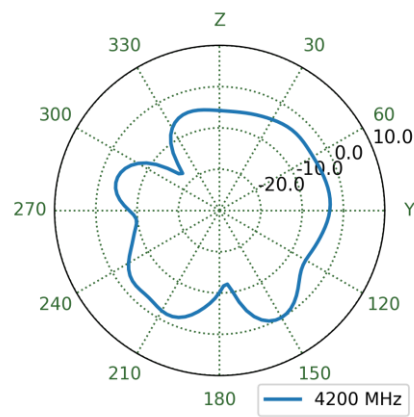
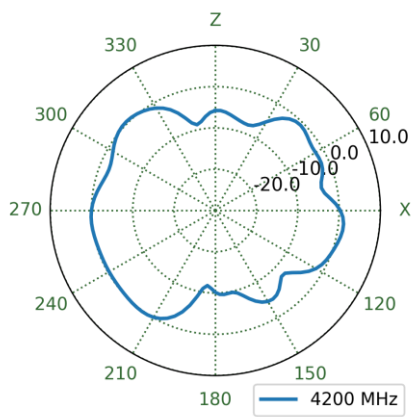

5150MHz

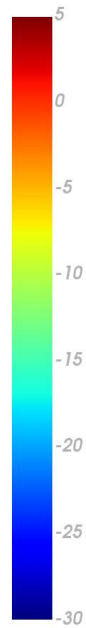
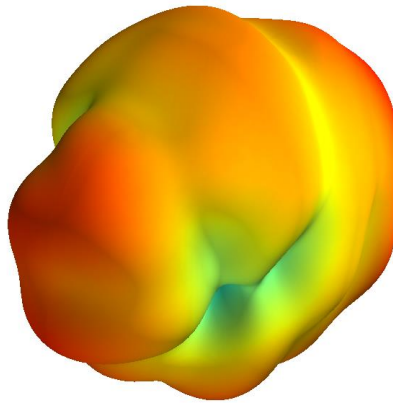
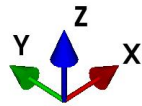

XZ Plane

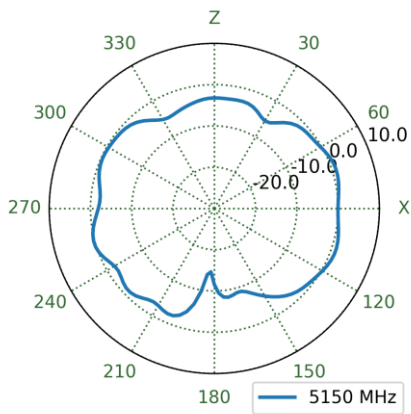

YZ Plane

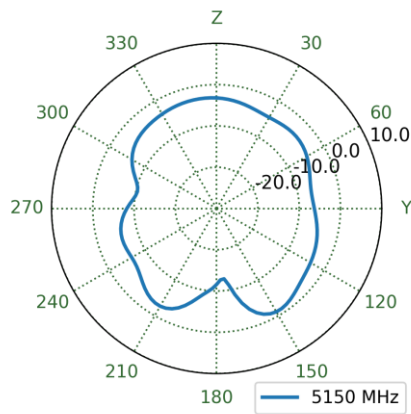

XY Plane

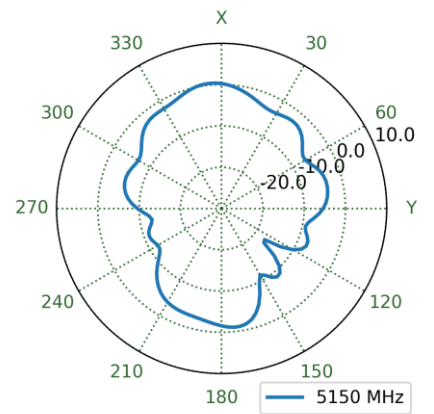

5550MHz

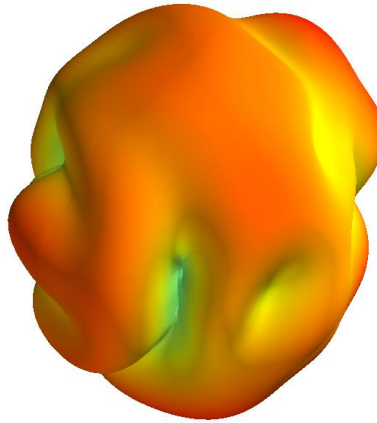
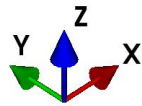

XZ Plane

YZ Plane

XY Plane

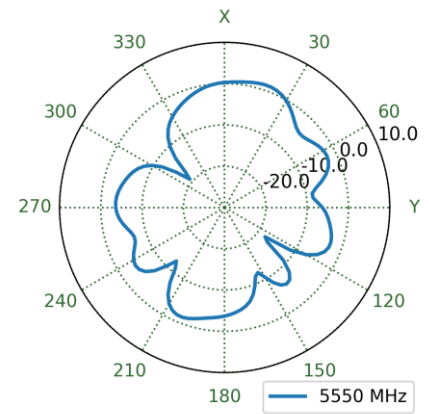
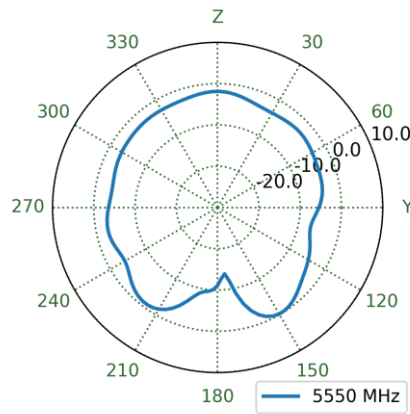
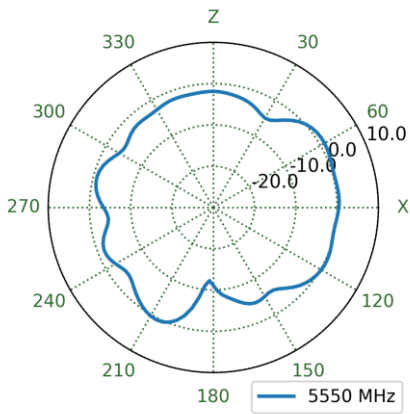

5925MHz

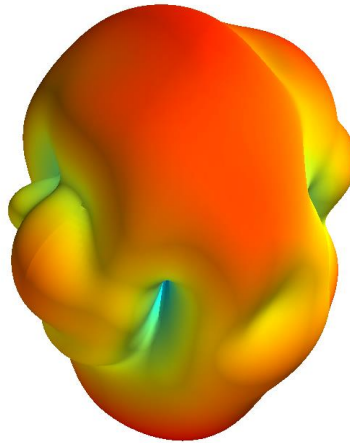
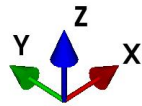

XZ Plane

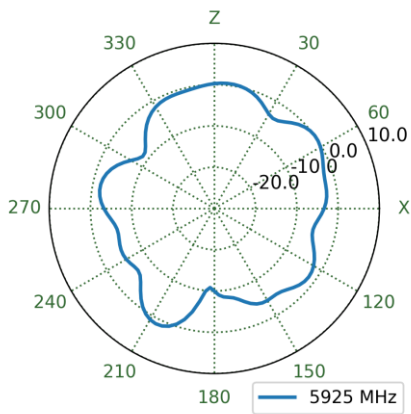

YZ Plane

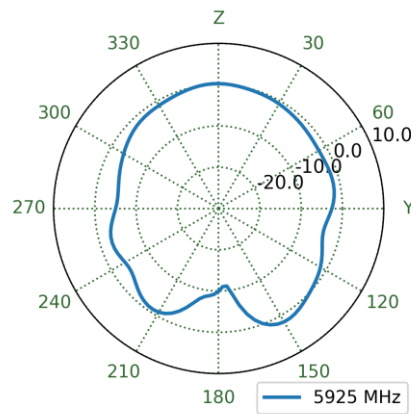

XY Plane

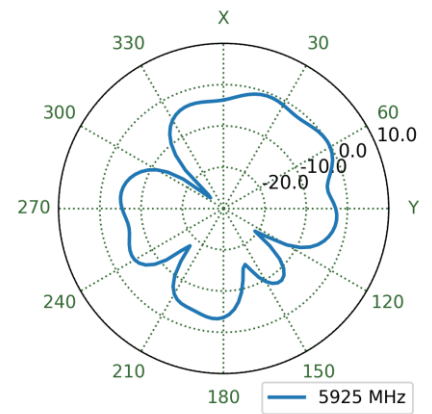

5. Mechanical Drawing (Units: mm)

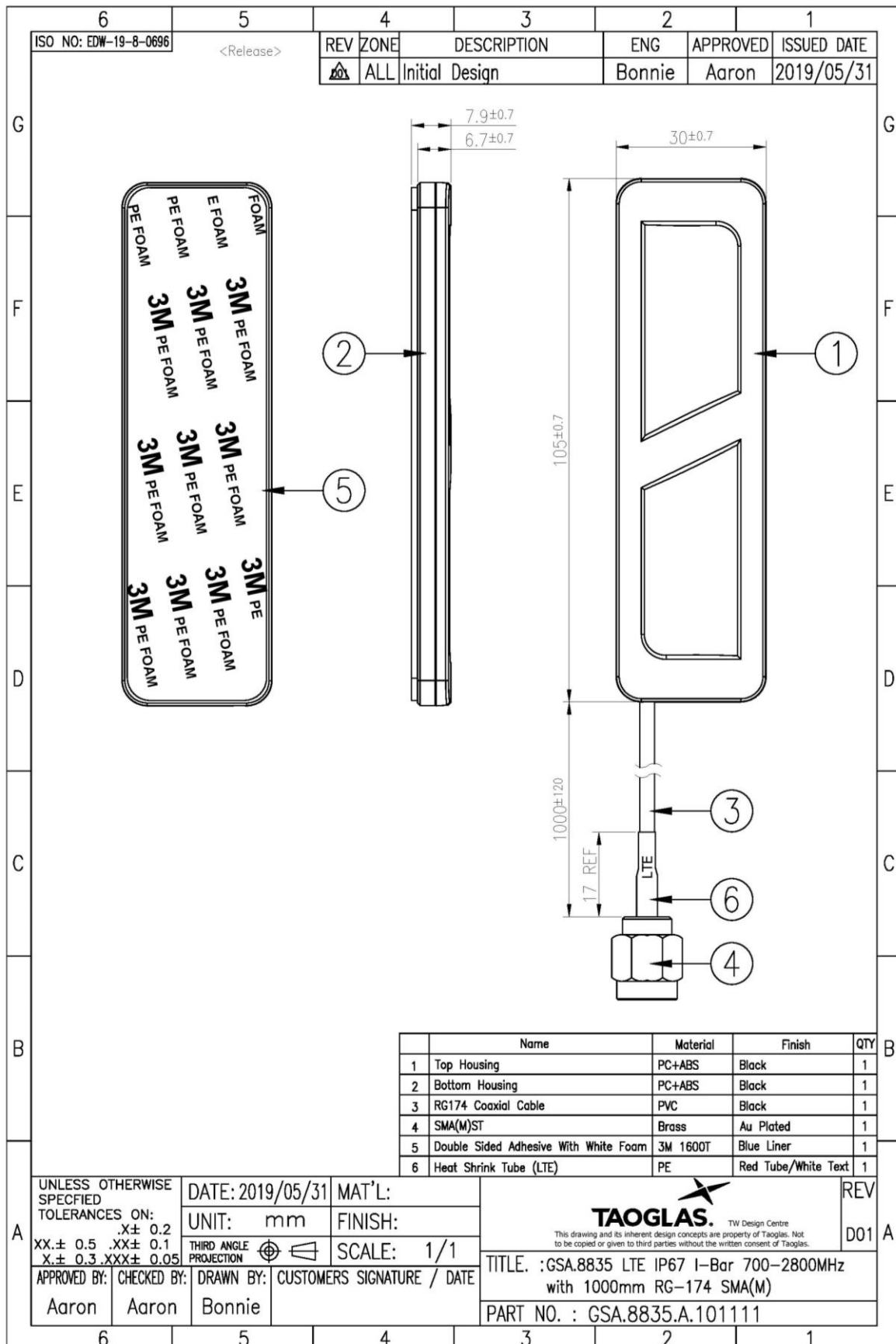

6. Packaging

1pcs GSA.8835.A.101111 per Small PE Bag
 Dimensions - 200*80mm
 Weight - 39g



10pcs GSA.8835.A.101111 per Large PE Bag
 Dimensions - 460*250mm
 Weight - 440g

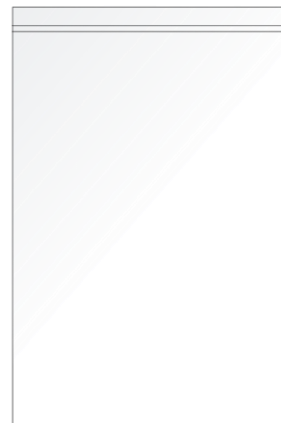

200pcs GSA.8835.A.101111 per carton
 Dimensions - 400*330*230mm
 Weight - 9.75Kg

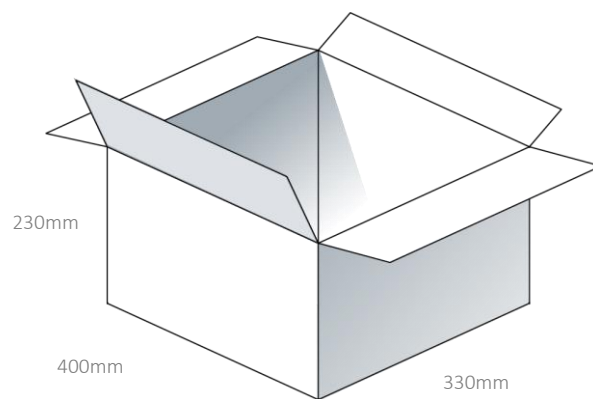

Pallet Dimensions:
 1200*1000*1350mm
 45 Cartons Per Pallet
 9 Cartons Per Layer, 5 Layers

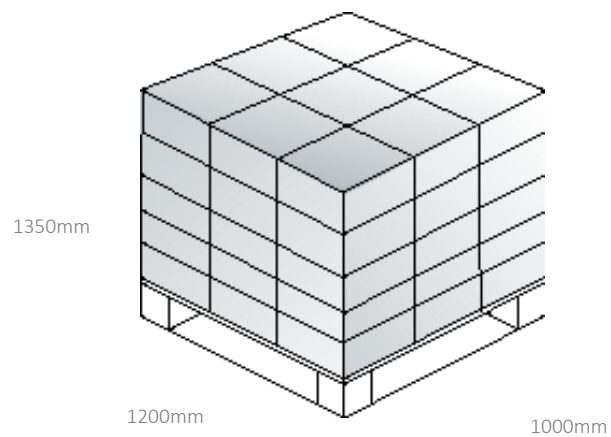

Changelog for the datasheet

SPE-19-8-112 – GSA.8835.A.101111

Revision: D (Current Version)

Date:	2023-07-12
Notes:	Updated Specifications
Author:	Jack Conroy

Previous Revisions

Revision: C

Date:	2022-10-27
Notes:	Updated Specifications
Author:	Cesar Sousa

Revision: B

Date:	2021-03-08
Notes:	Updated Antenna Weight.
Author:	Gary West

Revision: A (Original First Release)

Date:	2019-08-21
Notes:	
Author:	Jack Conroy