



TAOGLAS®



Datasheet

Part No:
GSA.8841.A.105111

Description:
Wideband 4G LTE I-Bar Antenna 698MHz to 6000MHz

Features:
5G/4G/ Wi-Fi Adhesive Mount Antenna
Dimension 176mm * 59mm *11.6mm
698MHz to 6000MHz
With 1M TGC-200 and SMA(M) Connector
RoHS & Reach Compliant

1. Introduction	3
2. Specifications	4
3. Antenna Characteristics	7
4. 2D Radiation Patterns	14
5. Mechanical Drawing	21
6. Packaging	22
7. Application Note	23
<hr/>	
Changelog	30

Taoglas makes no warranties based on the accuracy or completeness of the contents of this document and reserves the right to make changes to specifications and product descriptions at any time without notice. Taoglas reserves all rights to this document and the information contained herein.

Reproduction, use or disclosure to third parties without express permission is strictly prohibited.

Copyright © Taoglas Ltd.



1. Introduction



The GSA.8841 LTE Wideband I-Bar Antenna is an external adhesive mount solution on glass and plastic for automotive and telematics applications. It covers not only LTE, but all Cellular, ISM and Wi-Fi working frequencies in the 700-6000 MHz spectrum. It has the highest wide-band efficiency in its range of any antenna in its category today.

The GSA.8841 has been primarily designed for use with 4G LTE modules and devices that require the highest possible efficiency and peak gain to deliver best in class throughput on all major cellular 4G bands worldwide for telematics applications.

- High speed HD video
- Real-time streaming
- High capacity MIMO networks on public transportation

It comes with 1 meter of coaxial cable and SMA (M) connector, in a low profile compact format for mounting via high quality first tier automotive approved 3M adhesive foam. Stable radiation is observed on both glass and plastic.

The GSA.8841 is backward compatible with 3G and 2G cellular applications such as HSPA, as well as covering WI-FI bands, and even has GPS included for E911 applications.

It is an ideal solution for any device requiring high, reliable performance. It will meet nearly all carrier certification requirements from an efficiency standpoint. The antenna also makes an excellent reference antenna for test purposes. It has been designed as an omni-directional antenna and the radiation patterns show this and are stable across all bands.

2. Specifications

Electrical									
Standard	LTE/GSM/ CDMA 700/800/ 850/900	GNSS	LTE/GSM/ HSPA/CD MA 1700/180 0/ 1900	UMTS/ HSPA 2100	LTE 2300	Wi-Fi 2400	LTE 2600	LTE 3500	Wi-Fi 5800
Frequency (MHz)	698~960	1565 ~1612	1710 ~1990	1920 ~2170	2305 ~2360	2400 ~2500	2500 ~2700	3400 ~3600	4800~6000
Efficiency (%)									
In free space	0.3M	71.88	62.03	67.62	67.81		68.79	71.08	48.73
	1M	68.64	56.57	61.77	62.39		62.74	64.83	43.43
	2M	63.75	51.59	55.33	56.02		54.64	55.89	36.76
	3M	59.34	45.98	48.75	49.59		47.06	47.47	30.75
	5M	50.54	36.53	37.87	39.04		36.10	36.30	22.34
On 2mm ABS Base	0.3M	74.99	64.23	70.69	70.33		69.68	73.11	49.39
	1M	71.62	58.58	64.58	64.68		63.55	66.67	44.02
	2M	66.53	53.42	57.85	58.07		55.35	57.49	37.25
	3M	61.93	47.61	50.97	51.41		47.67	48.82	31.16
	5M	52.78	37.82	39.60	40.45		36.57	37.33	22.63
On Glass Base	0.3M	74.73	73.00	80.37	77.79		64.27	69.10	55.18
	1M	71.86	66.58	73.41	71.51		58.62	63.02	49.18
	2M	67.23	60.72	65.79	64.21		51.05	54.33	41.44
	3M	64.50	54.12	57.94	56.81		43.97	46.14	34.81
	5M	55.06	42.99	45.03	44.67		33.73	35.28	24.97
Average Gain(dBi)									
In free space	0.3M	-1.46	-2.08	-1.72	-1.71		-1.63	-1.49	-3.22
	1M	-1.66	-2.48	-2.12	-2.07		-2.03	-1.89	-3.72
	2M	-1.98	-2.88	-2.59	-2.54		-2.63	-2.53	-4.45
	3M	-2.29	-3.38	-3.14	-3.07		-3.28	-3.24	-5.22
	5M	-2.99	-4.38	-4.23	-4.11		-4.43	-4.41	-6.62
On 2mm ABS Base	0.3M	-1.29	-1.93	-1.52	-1.55		-1.57	-1.37	-3.13
	1M	-1.49	-2.33	-1.92	-1.91		-1.97	-1.77	-3.63
	2M	-1.81	-2.73	-2.39	-2.38		-2.57	-2.41	-4.37
	3M	-2.12	-3.23	-2.94	-2.91		-3.22	-3.12	-5.13
	5M	-2.82	-4.23	-4.04	-3.95		-4.37	-4.28	-6.53
On the Glass Base	0.3M	-1.33	-1.37	-0.96	-1.11		-1.92	-1.62	-2.62
	1M	-1.50	-1.77	-1.35	-1.47		-2.32	-2.02	-3.12
	2M	-1.80	-2.17	-1.83	-1.94		-2.92	-2.66	-3.87
	3M	-2.02	-2.67	-2.38	-2.47		-3.57	-3.37	-4.62
	5M	-2.72	-3.67	-3.47	-3.51		-4.72	-4.53	-6.07

Peak Gain(dBi)									
Standard	LTE/GSM/CDMA 700/800/ 850/900	GNSS	LTE/GSM/ HSPA/CD MA 1700/180 0/ 1900	UMTS/ HSPA 2100	LTE 2300	Wi-Fi 2400	LTE 2600	LTE 3500	Wi-Fi 5800
Frequency (MHz)	698~960	1565 ~1612	1710 ~1990	1920 ~2170	2305 ~2360	2400 ~2500	2500 ~2700	3400 ~3600	4800~6 000
In free space	0.3M	1.56	1.38	3.79	3.06		4.25	4.70	2.56
	1M	1.36	0.98	3.40	2.69		3.85	4.30	2.06
	2M	1.04	0.58	2.92	2.23		3.25	3.66	1.33
	3M	0.73	0.08	2.37	1.70		2.60	2.95	0.56
	5M	0.03	-0.92	1.28	0.66		1.45	1.79	-0.84
On 2mm ABS Base	0.3M	1.65	1.74	3.85	3.13		5.00	5.27	2.08
	1M	1.45	1.34	3.46	2.76		4.60	4.87	1.58
	2M	1.13	0.94	2.99	2.30		4.00	4.23	0.84
	3M	0.81	0.44	2.44	1.77		3.35	3.52	0.08
	5M	0.11	-0.56	1.34	0.73		2.20	2.35	-1.32
On Glass Base	0.3M	1.52	3.20	4.76	4.12		5.75	5.35	4.14
	1M	1.32	2.80	4.37	3.76		5.35	4.95	3.64
	2M	0.99	2.40	3.89	3.29		4.75	4.31	2.89
	3M	0.68	1.90	3.34	2.76		4.10	3.60	2.14
	5M	-0.02	0.90	2.25	1.72		2.95	2.44	0.69
Impedance			50Ω						
Polarization			Linear						
Radiation Pattern			Omni						
Input Power			5 W						

Mechanical

Casing	ABS
Coaxial Cable	TGC-200 Low Loss Cable
Cable Length	1 Meter Standard, Fully Customizable
Connector	SMA Male Standard, Fully Customizable
Adhesive	3M9448+CR4305 Double Sided Adhesive
Weight	127g

Environmental

Operation Temperature Range	-40°C to 85°C
Storage Temperature Range	-40°C to 85°C
Humidity	Non-condensing 65°C 95% RH

LTE BANDS			
Band Number	LTE / LTE-Advanced / WCDMA / HSPA / HSPA+ / TD-SCDMA		
	Uplink	Downlink	Covered
1	UL: 1920 to 1980	DL: 2110 to 2170	✓
2	UL: 1850 to 1910	DL: 1930 to 1990	✓
3	UL: 1710 to 1785	DL: 1805 to 1880	✓
4	UL: 1710 to 1755	DL: 2110 to 2155	✓
5	UL: 824 to 849	DL: 869 to 894	✓
7	UL: 2500 to 2570	DL: 2620 to 2690	✓
8	UL: 880 to 915	DL: 925 to 960	✓
9	UL: 1749.9 to 1784.9	DL: 1844.9 to 1879.9	✓
11	UL: 1427.9 to 1447.9	DL: 1475.9 to 1495.9	✗
12	UL: 699 to 716	DL: 729 to 746	✓
13	UL: 777 to 787	DL: 746 to 756	✓
14	UL: 788 to 798	DL: 758 to 768	✓
17	UL: 704 to 716	DL: 734 to 746 (LTE only)	✓
18	UL: 815 to 830	DL: 860 to 875 (LET only)	✓
19	UL: 830 to 845	DL: 875 to 890	✓
20	UL: 832 to 862	DL: 791 to 821	✓
21	UL: 1447.9 to 1462.9	DL: 1495.9 to 1510.9	✗
22	UL: 3410 to 3490	DL: 3510 to 3590	✗
23	UL: 2000 to 2020	DL: 2180 to 2200 (LTE only)	✓
24	UL: 1625.5 to 1660.5	DL: 1525 to 1559 (LTE only)	✓
25	UL: 1850 to 1915	DL: 1930 to 1995	✓
26	UL: 814 to 849	DL: 859 to 894	✓
27	UL: 807 to 824	DL: 852 to 869 (LTE only)	✓
28	UL: 703 to 748	DL: 758 to 803 (LTE only)	✓
29	UL: -	DL: 717 to 728 (LTE only)	✓
30	UL: 2305 to 2315	DL: 2350 to 2360 (LTE only)	✓
31	UL: 452.5 to 457.5	DL: 462.5 to 467.5 (LTE only)	✗
32	UL: -	DL: 1452 - 1496	✗
35		1850 to 1910	✓
38		2570 to 2620	✓
39		1880 to 1920	✓
40		2300 to 2400	✓
41		2496 to 2690	✓
42		3400 to 3600	✓
43		3600 to 3800	✗

*Covered bands represent an efficiency greater than 20%

3. Antenna Characteristics

3.1 Testing setup



In free space

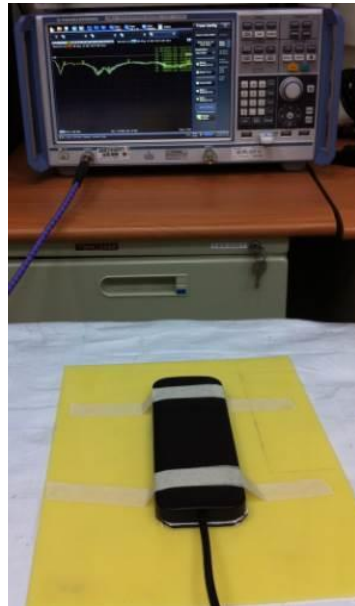

On 2mm ABS Base



On Glass Base

3.2 Return loss

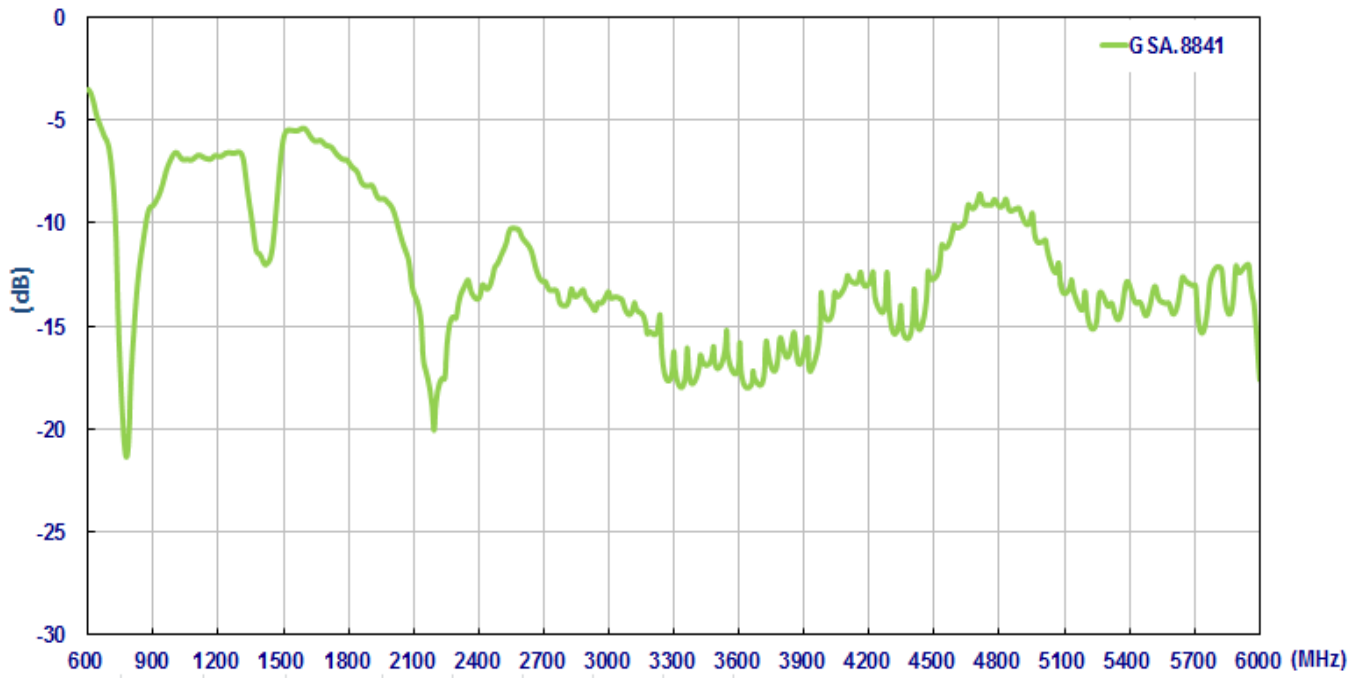

Figure2. Return loss of GSA.8841 with 1 meter cable length in free space

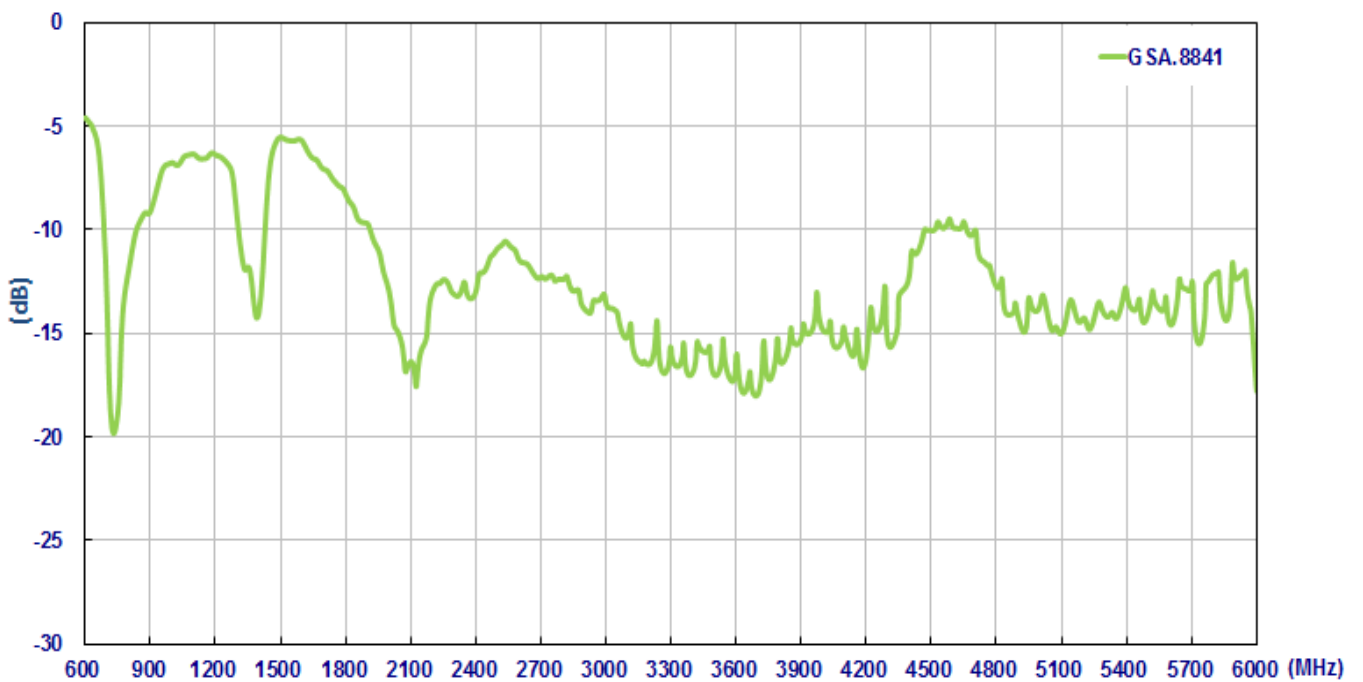

Figure3. Return loss of GSA.8841 with 1 meter cable length on the 2mm ABS base

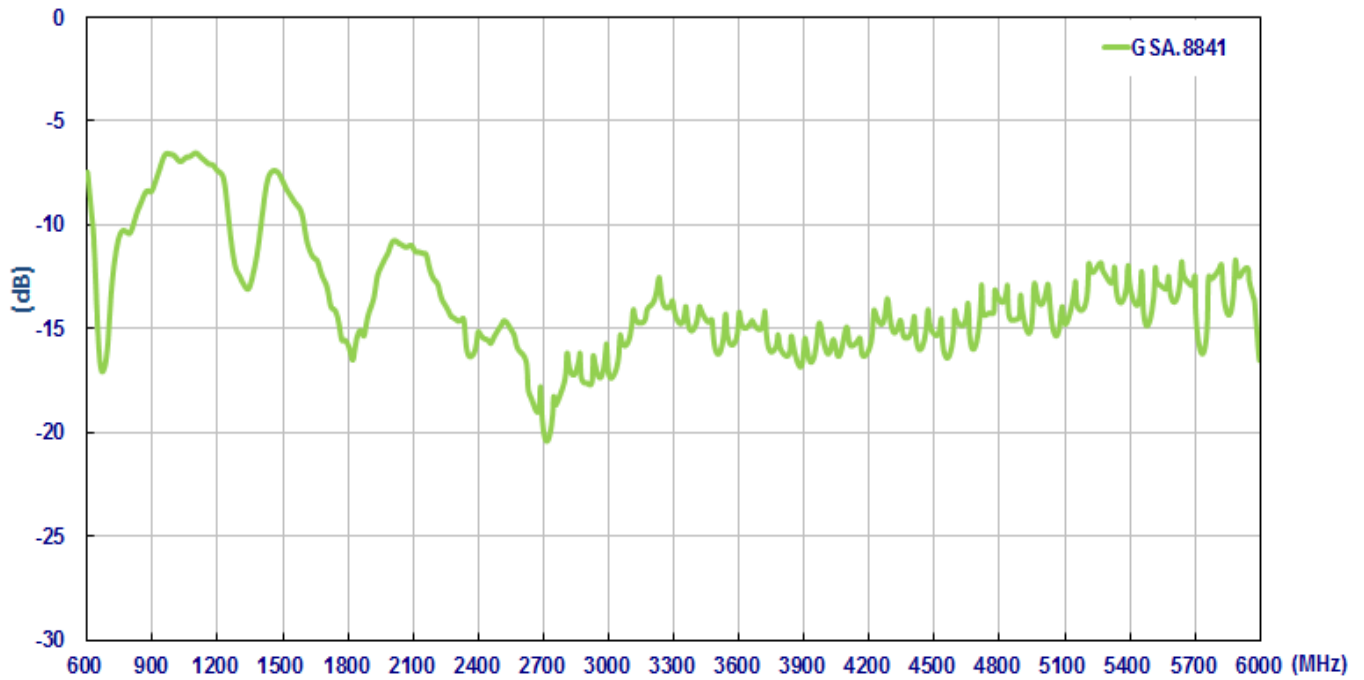

Figure4. Return loss of GSA.8841 with 1 meter cable length on the glass base

3.3 Efficiency

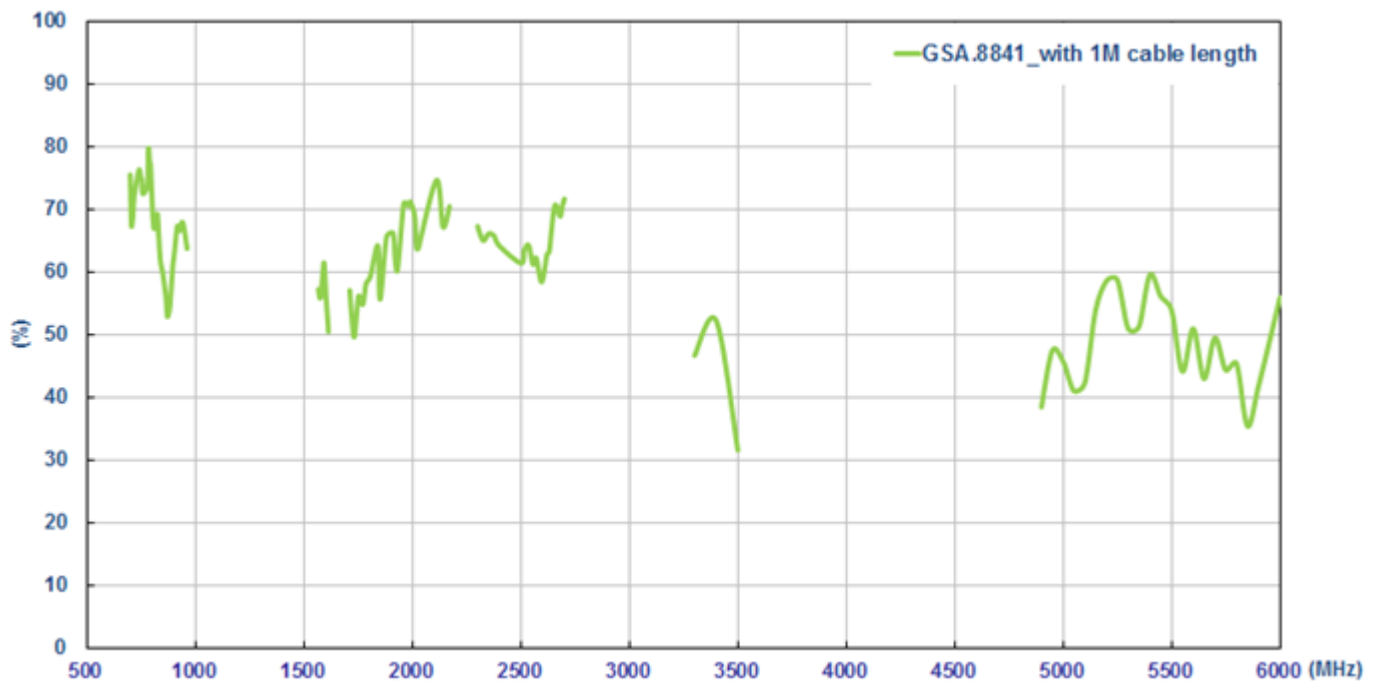

Figure5. Efficiency of GSA.8841 with 1 meter cable length in free space

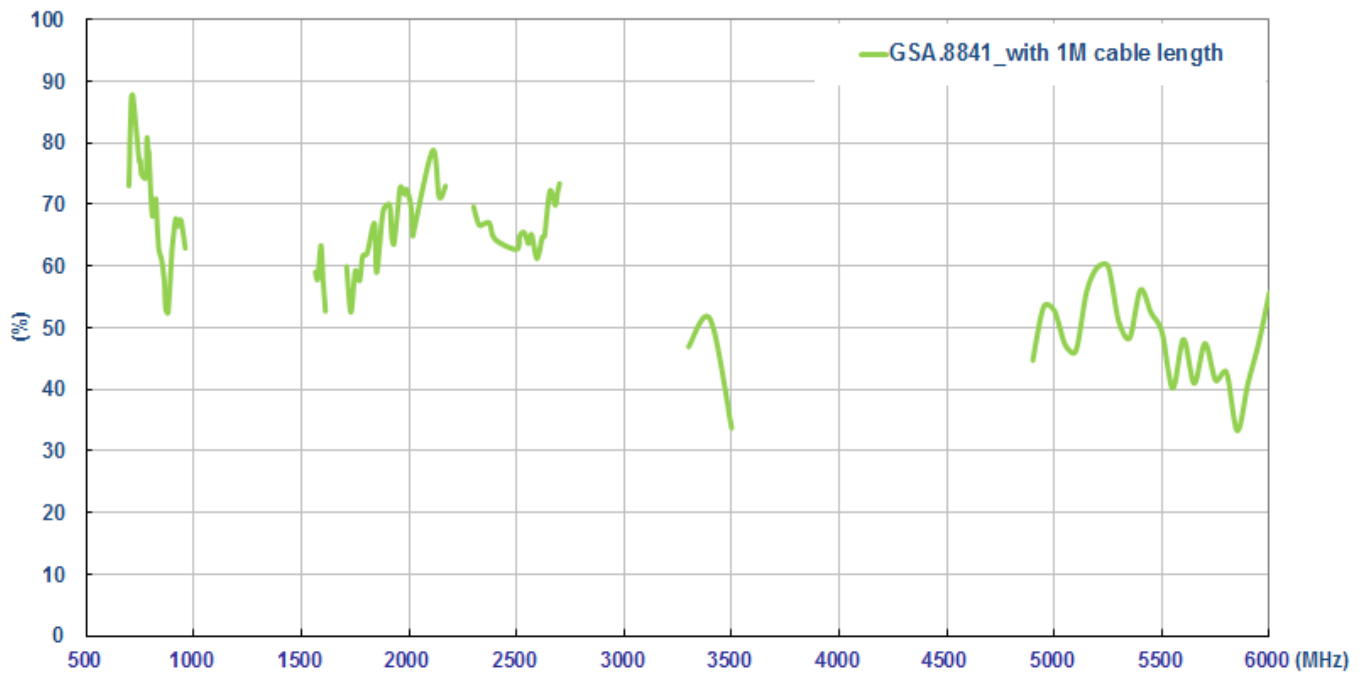

Figure6. Efficiency of GSA.8841 with 1 meter cable length on the 2mm ABS base

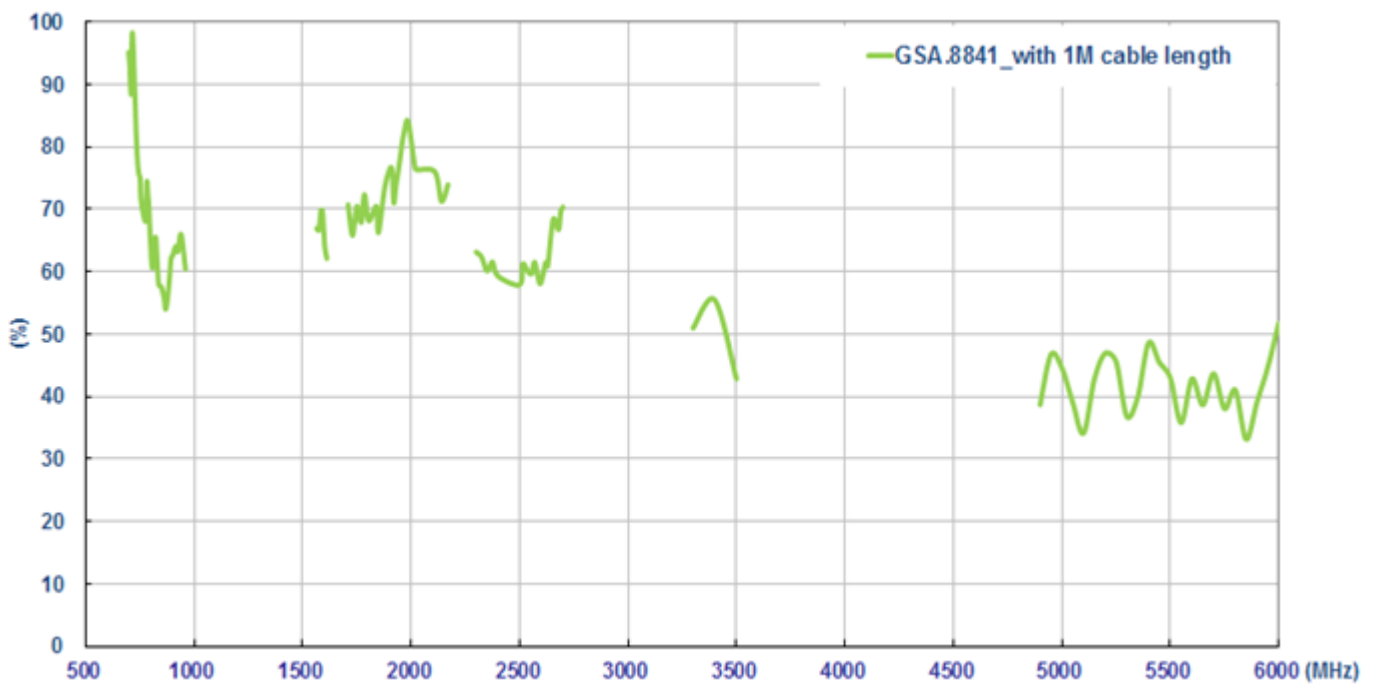

Figure7. Efficiency of GSA.8841 with 1 meter cable length on the glass base

3.4 Peak gain

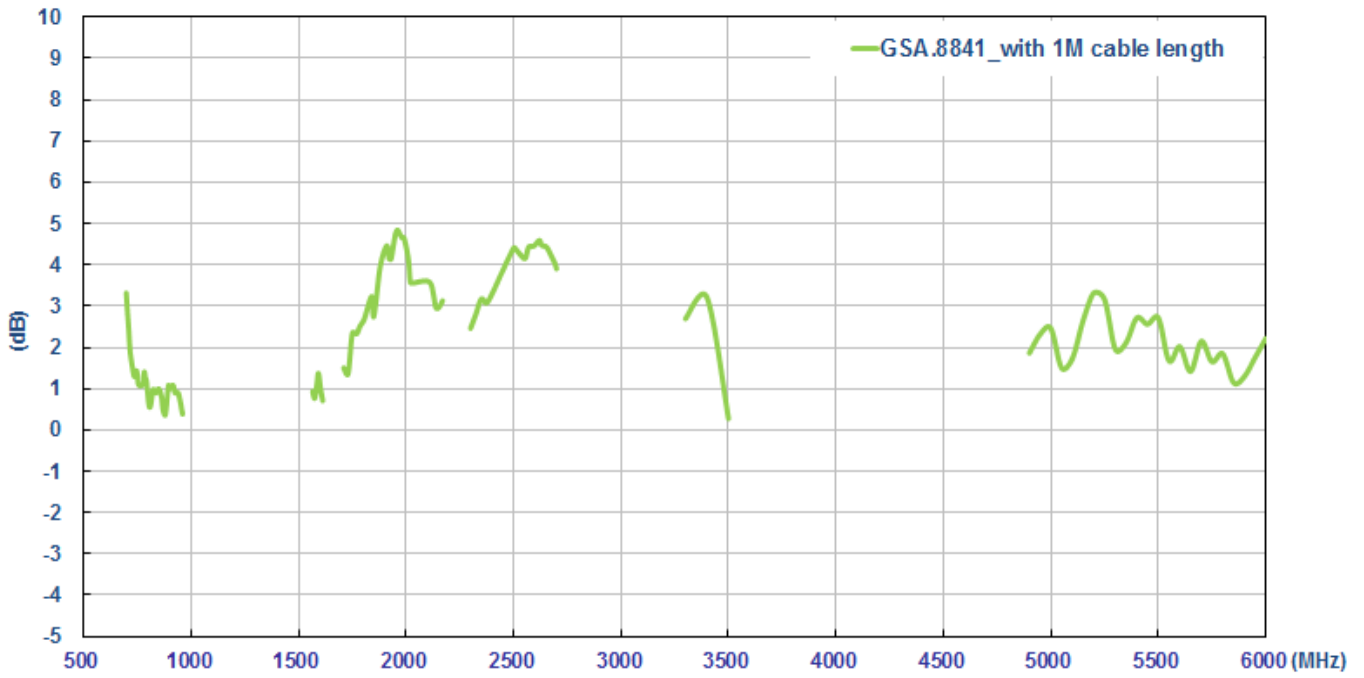

Figure8. Peak gain of GSA.8841 with 1 meter cable length in free space

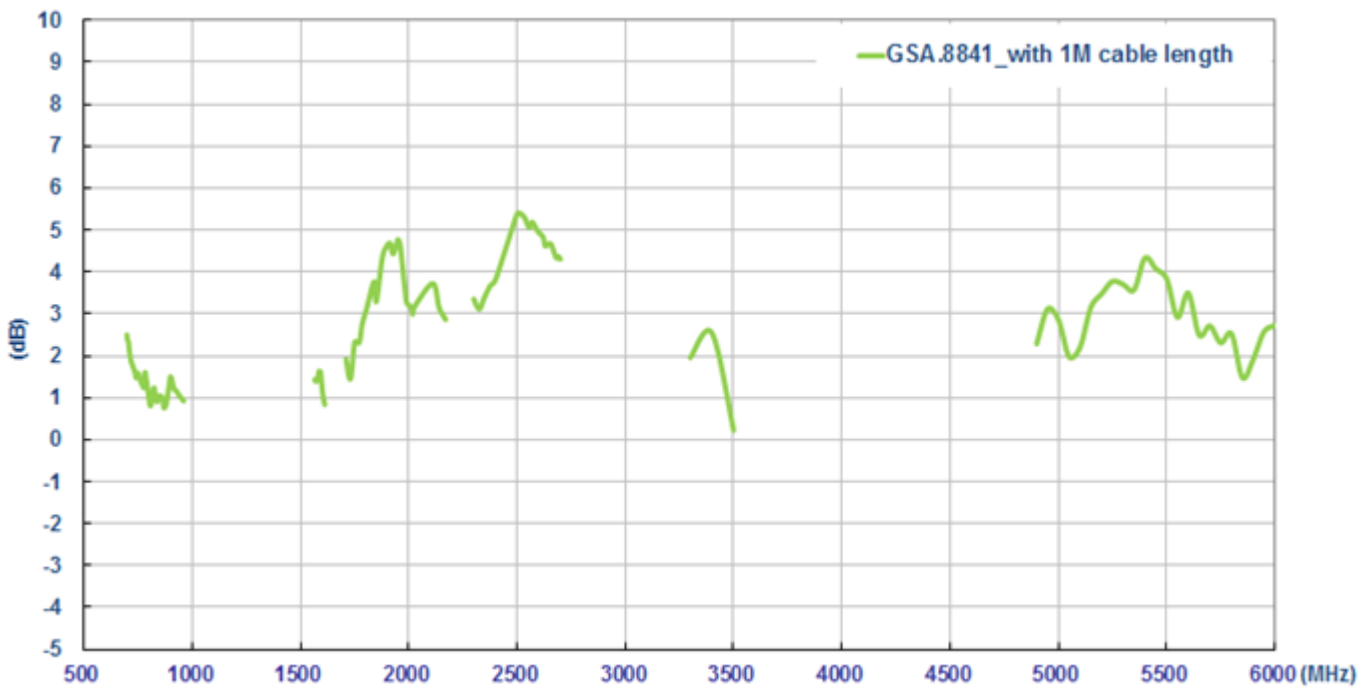

Figure9. Peak gain of GSA.8841 with 1 meter cable length on the 2mm ABS base

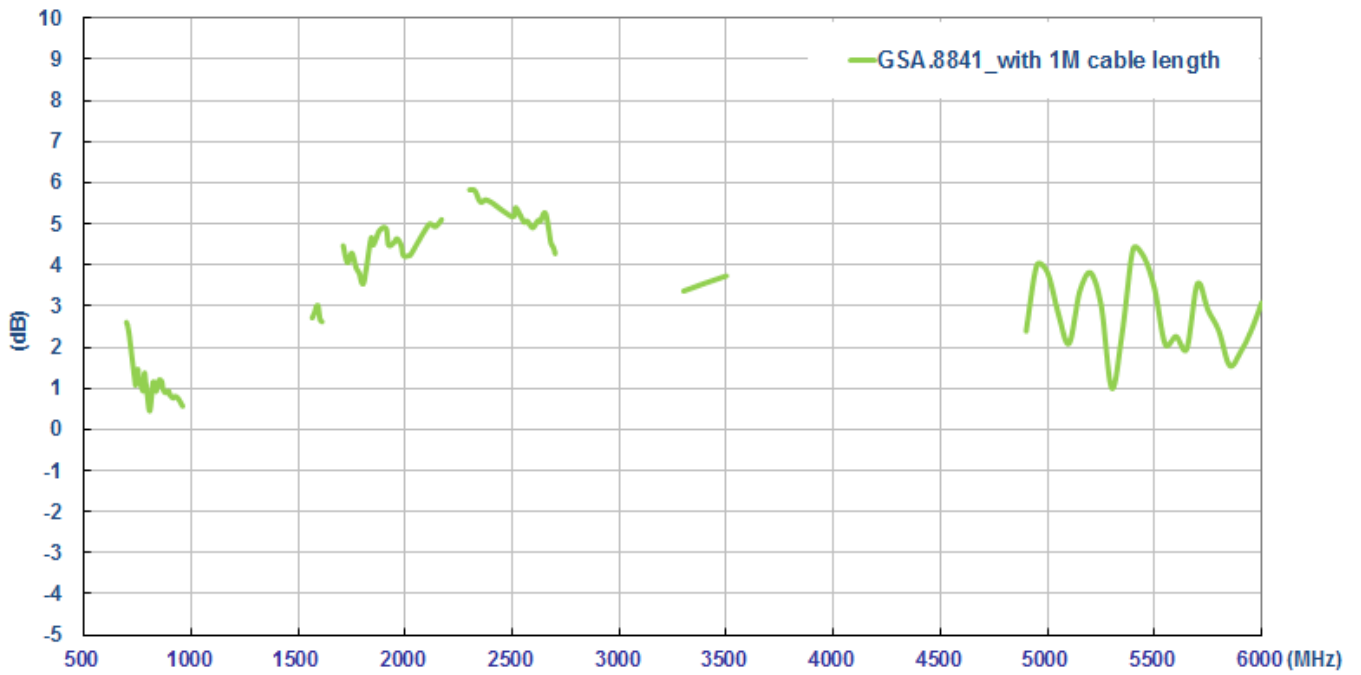

Figure10. Peak gain of GSA.8841 with 1 meter cable length on the glass base

3.5 Average gain

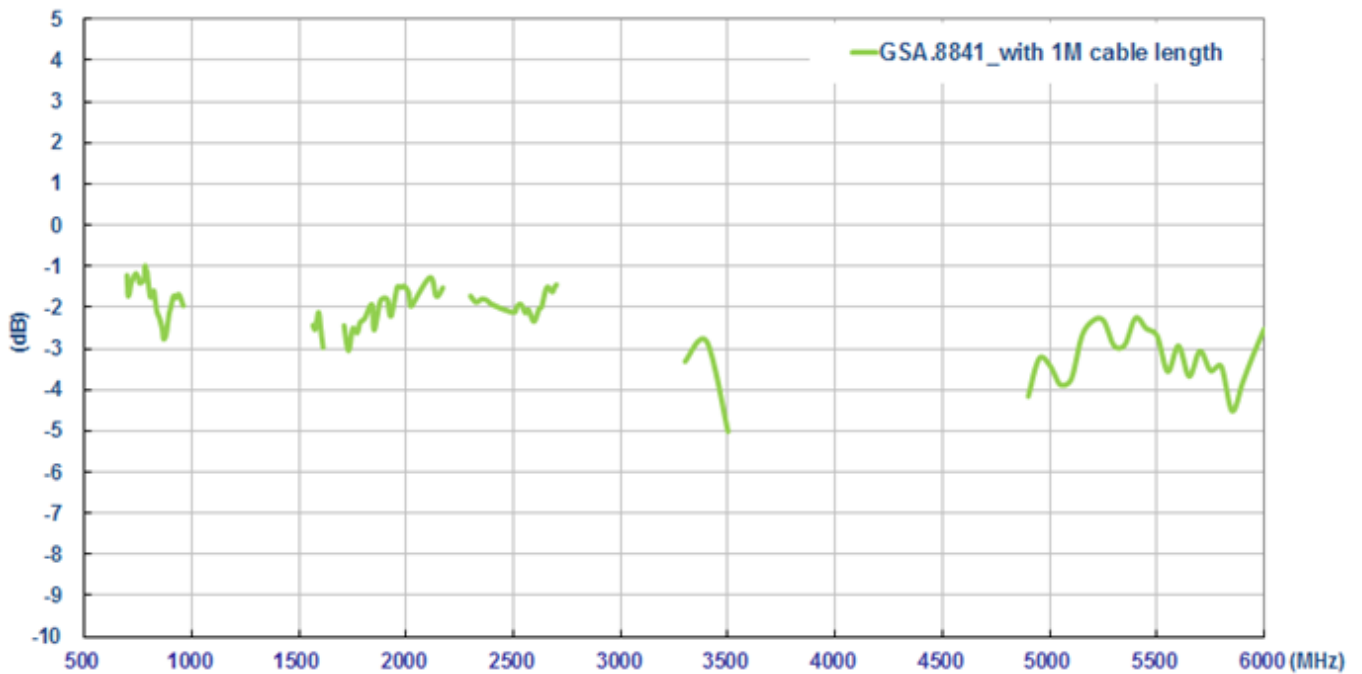

Figure11. Average gain of GSA.8841 with 1 meter cable length in free space

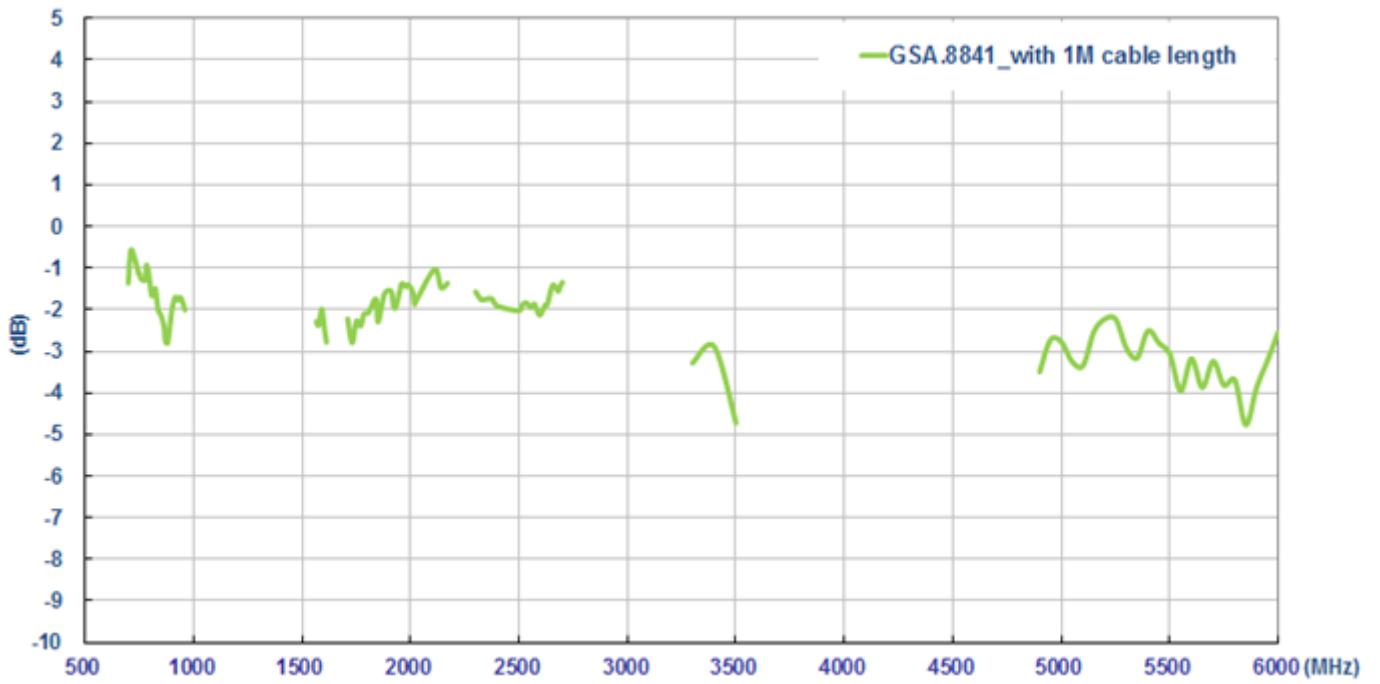

Figure12. Average gain of GSA.8841 with 1 meter cable length on the 2mm ABS base

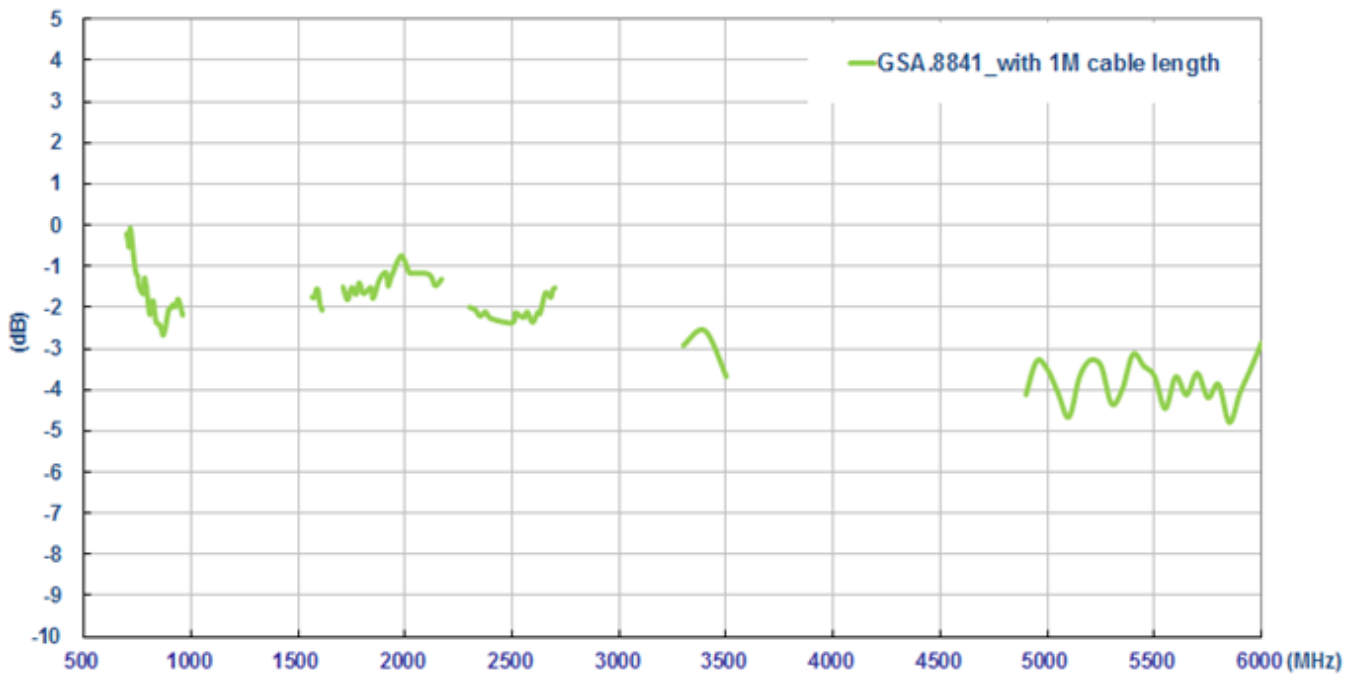
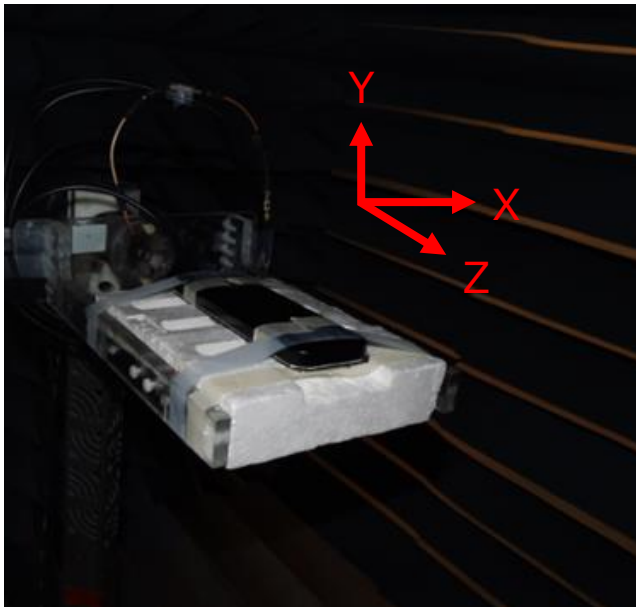

Figure13. Average gain of GSA.8841 with 1 meter cable length on the glass base

4. 2D Radiation Patterns



In free space



On 2mm ABS base

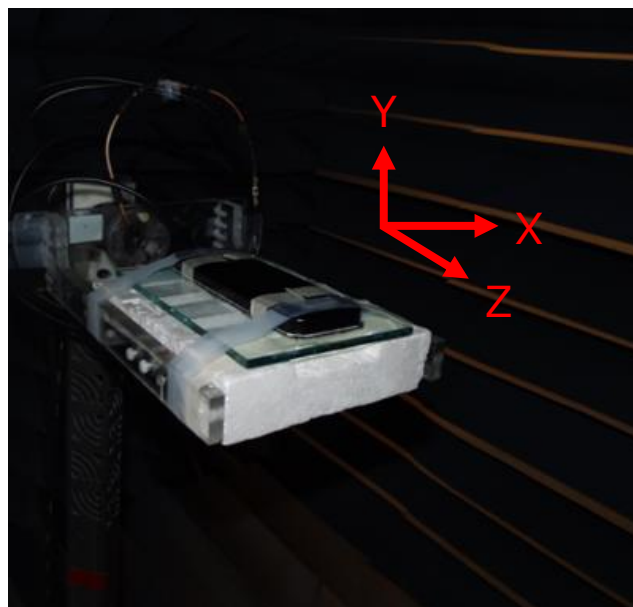

3) On the glass base

Figure.14 The measurement setup; a) In free space, b) On the 2mm ABS base, c) On the glass base

4.1 Antenna with 1 meter cable length in free space

XY Plane

XZ Plane

YZ Plane

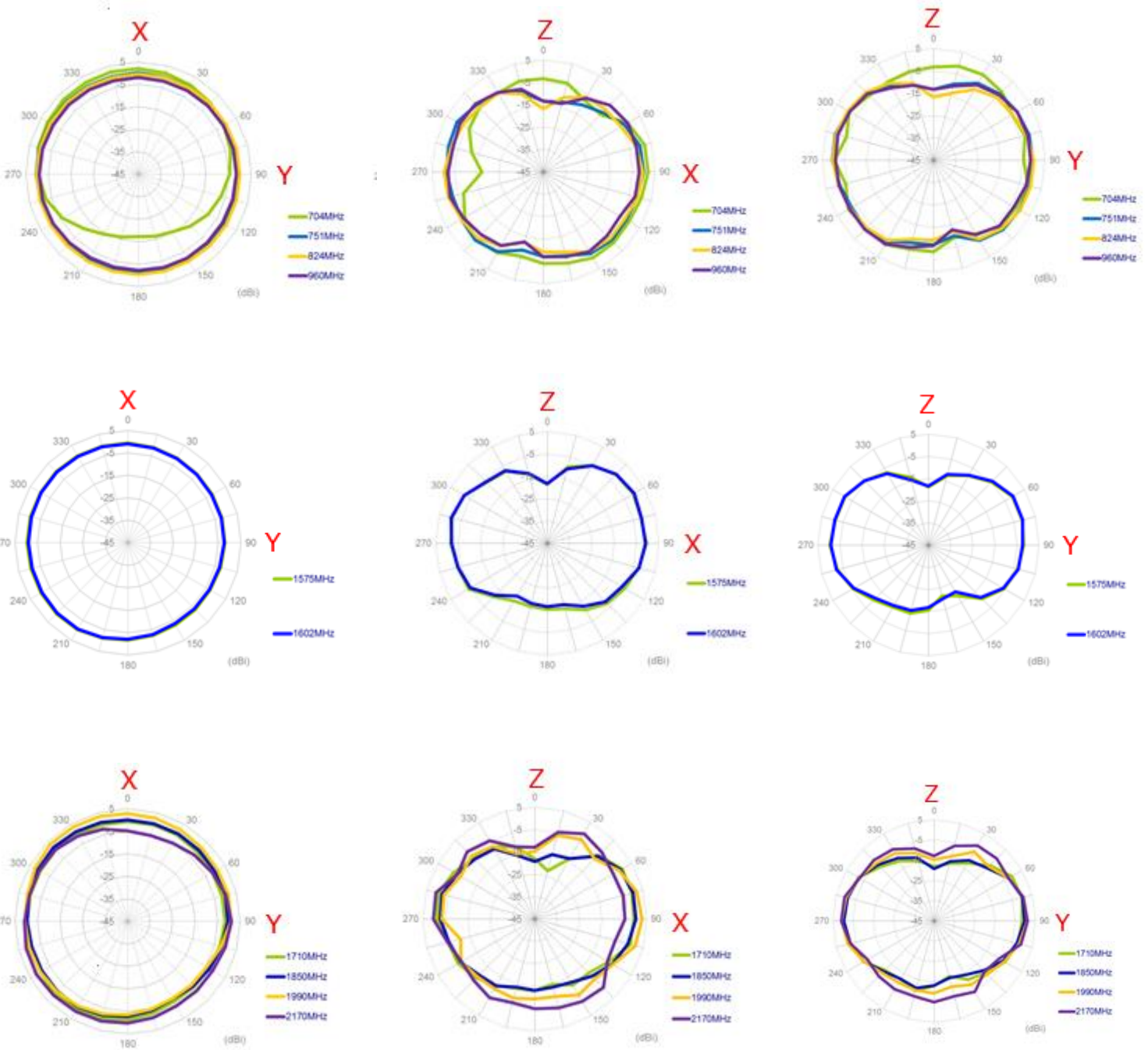

XY Plane

XZ Plane

YZ Plane

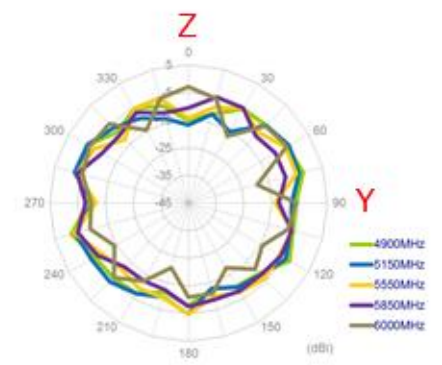
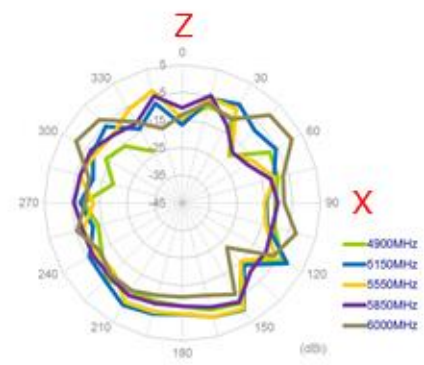
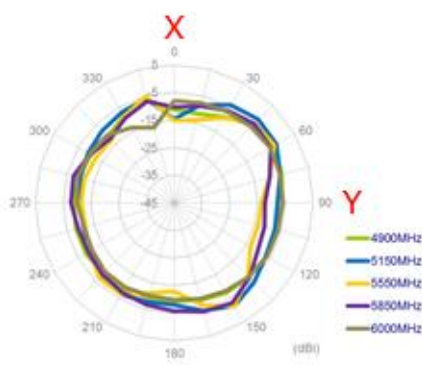
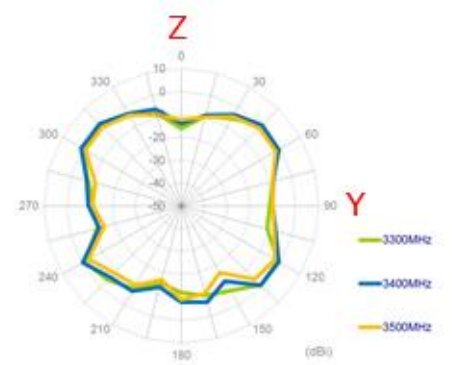
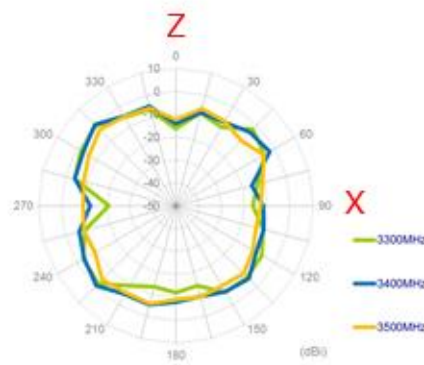
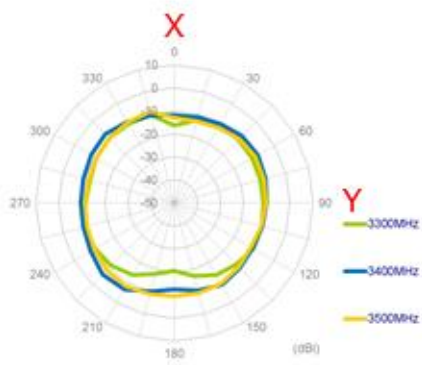
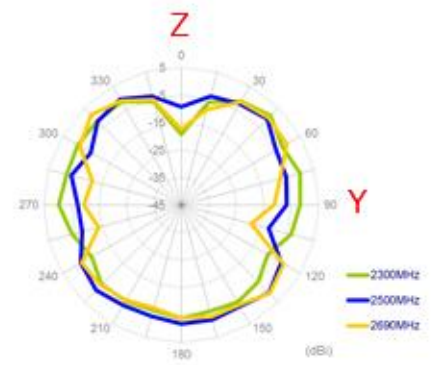
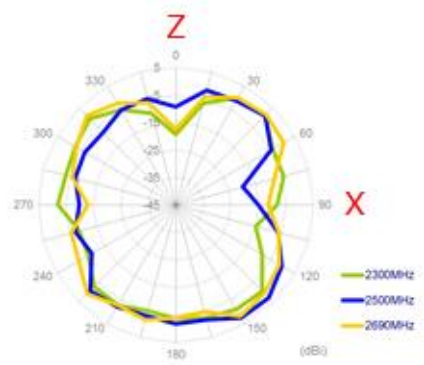
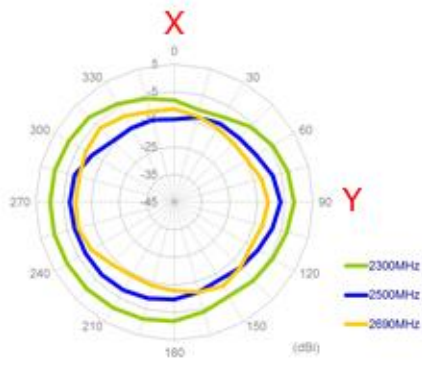

4.2 Antenna with 1 meter cable length on 2mm ABS

XY Plane

XZ Plane

YZ Plane

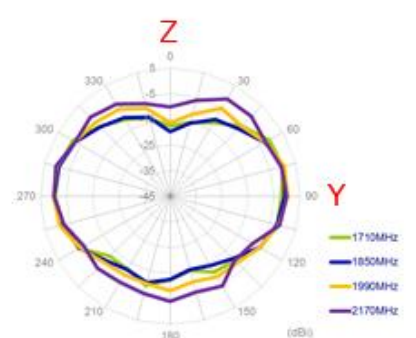
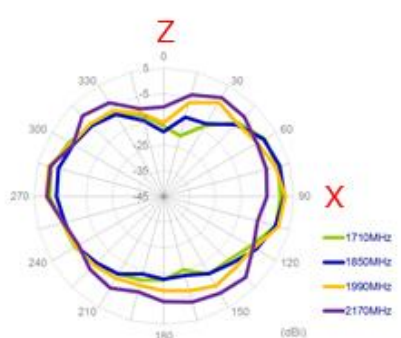
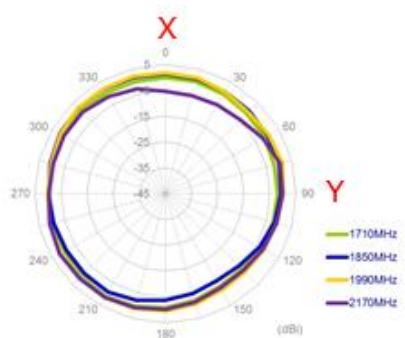
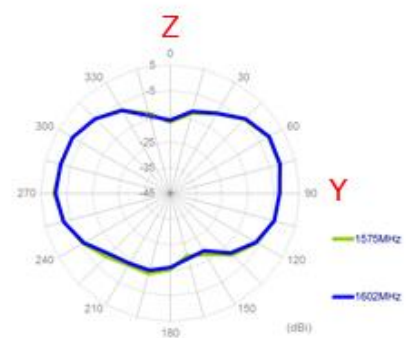
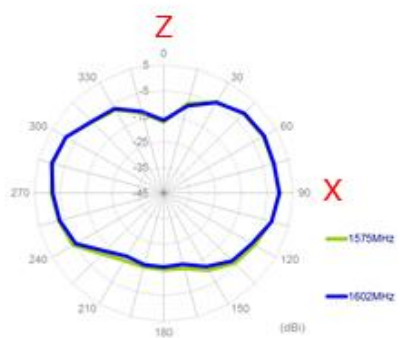
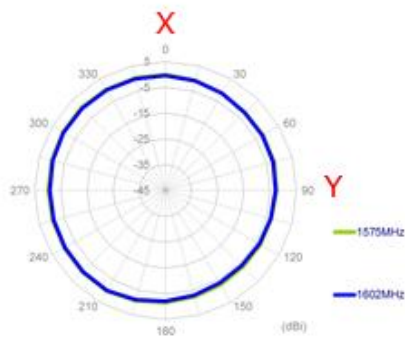
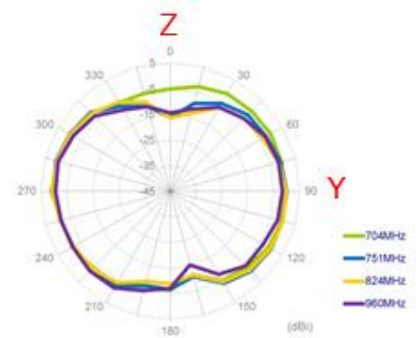
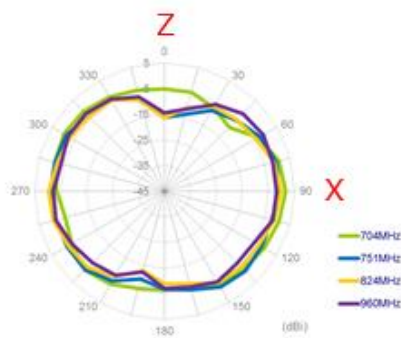
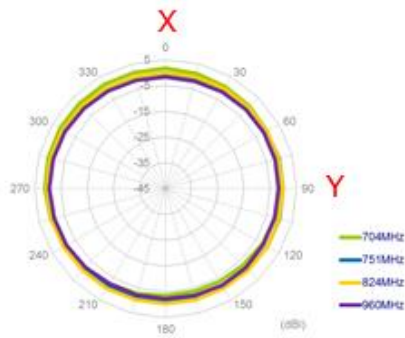

XY Plane

XZ Plane

YZ Plane

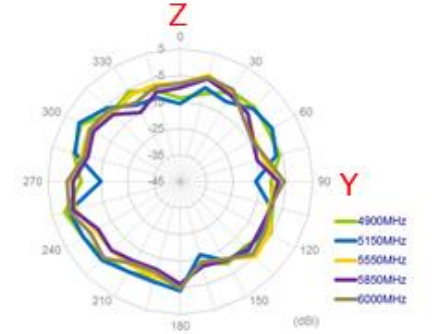
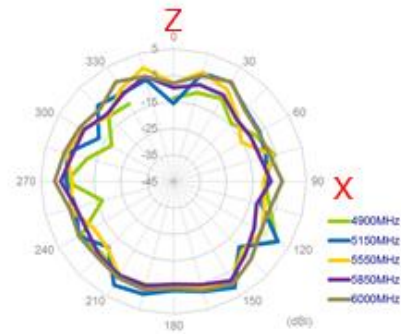
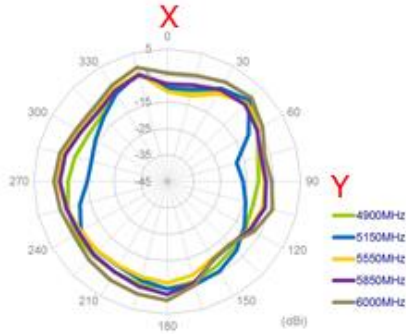
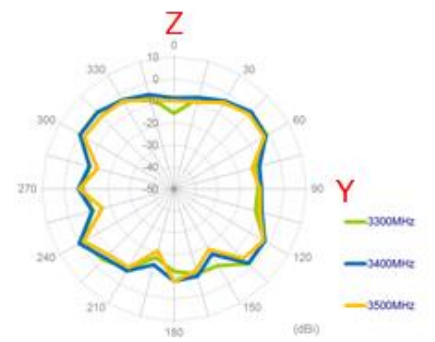
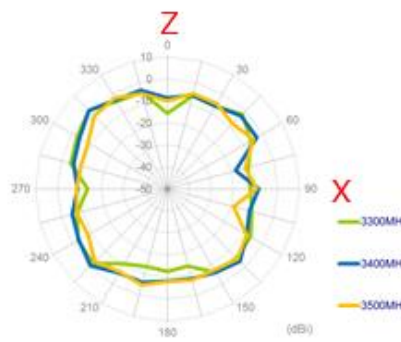
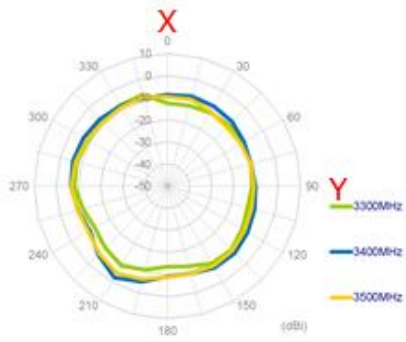
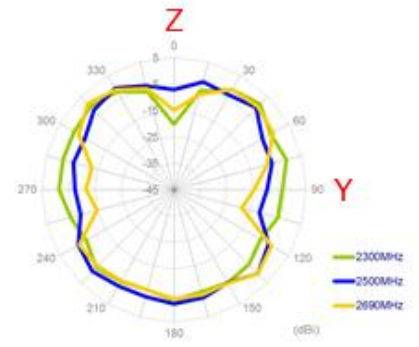
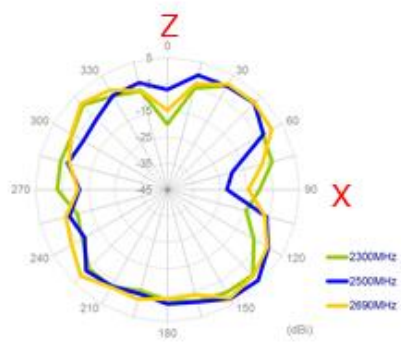
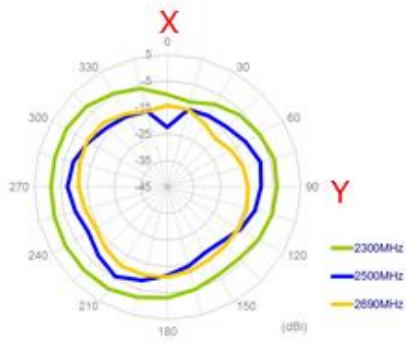

4.3 Antenna with 1 meter cable length on Glass Base

XY Plane

XZ Plane

YZ Plane

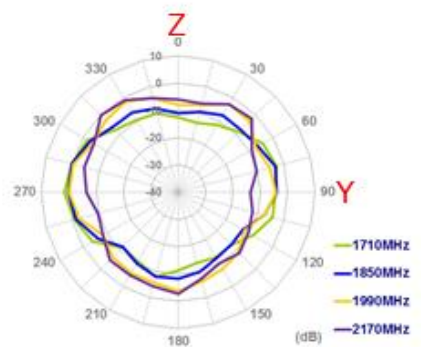
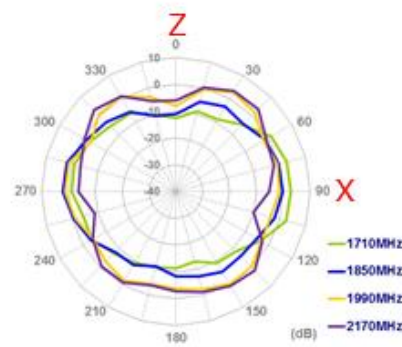
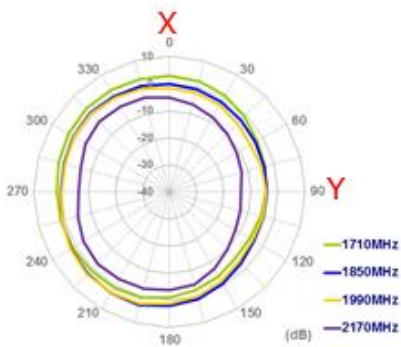
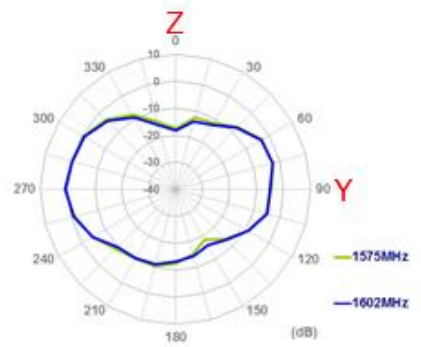
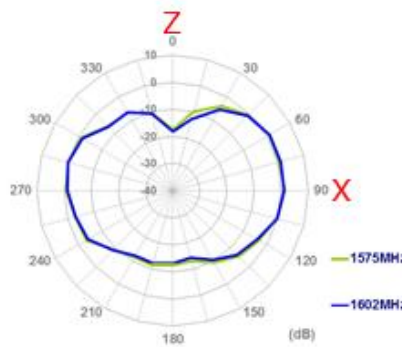
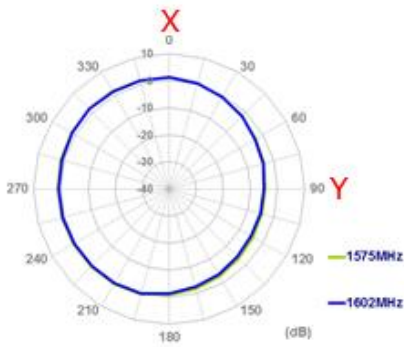
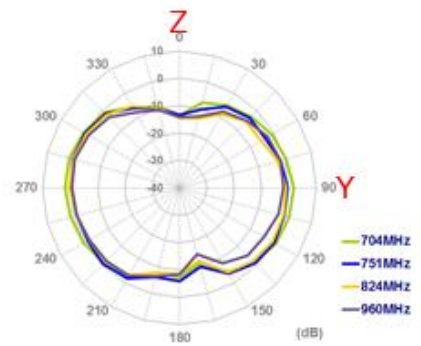
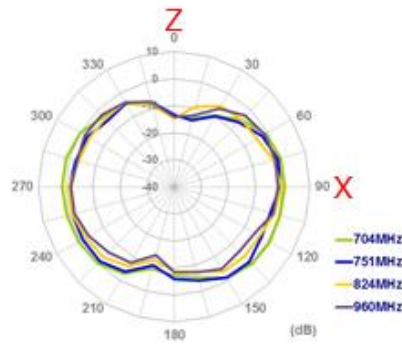
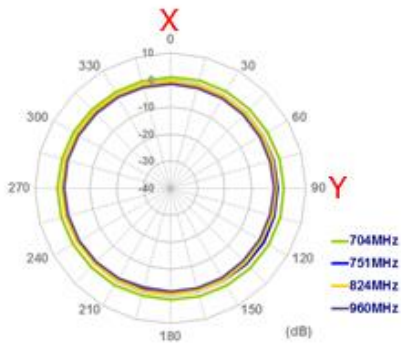

XY Plane

XZ Plane

YZ Plane

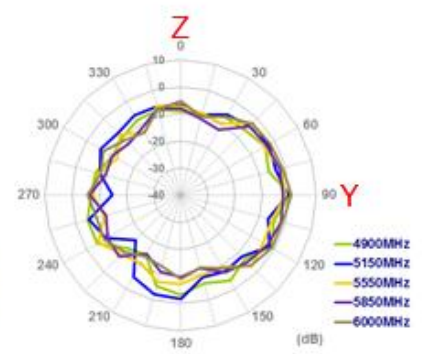
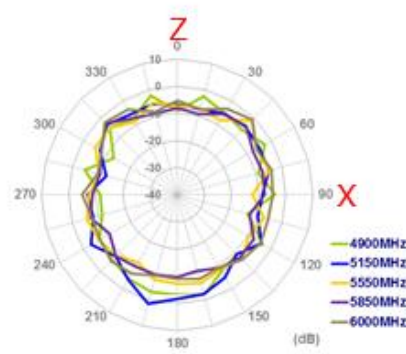
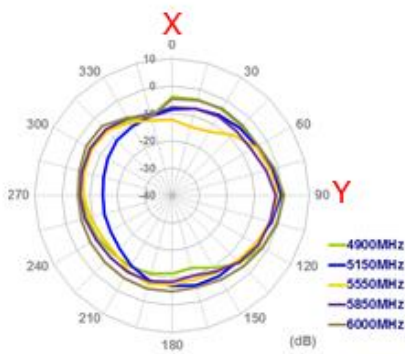
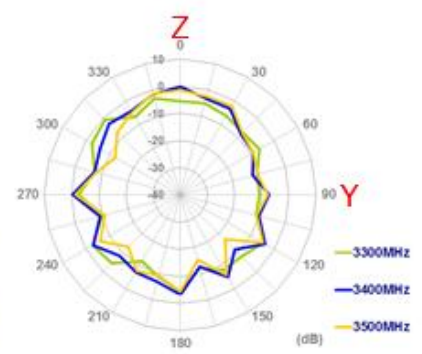
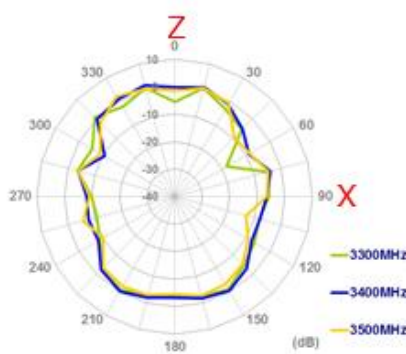
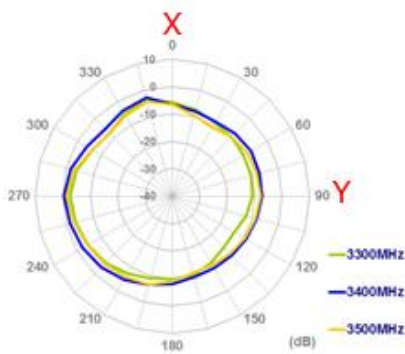
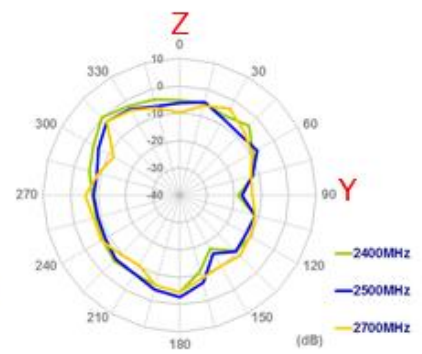
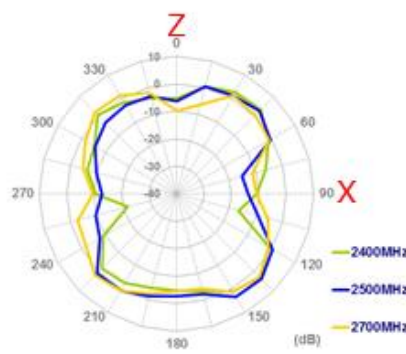
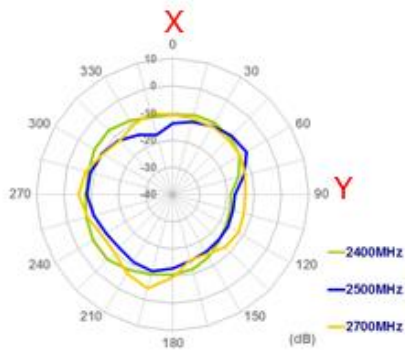

5. Mechanical Drawing (Units: mm)

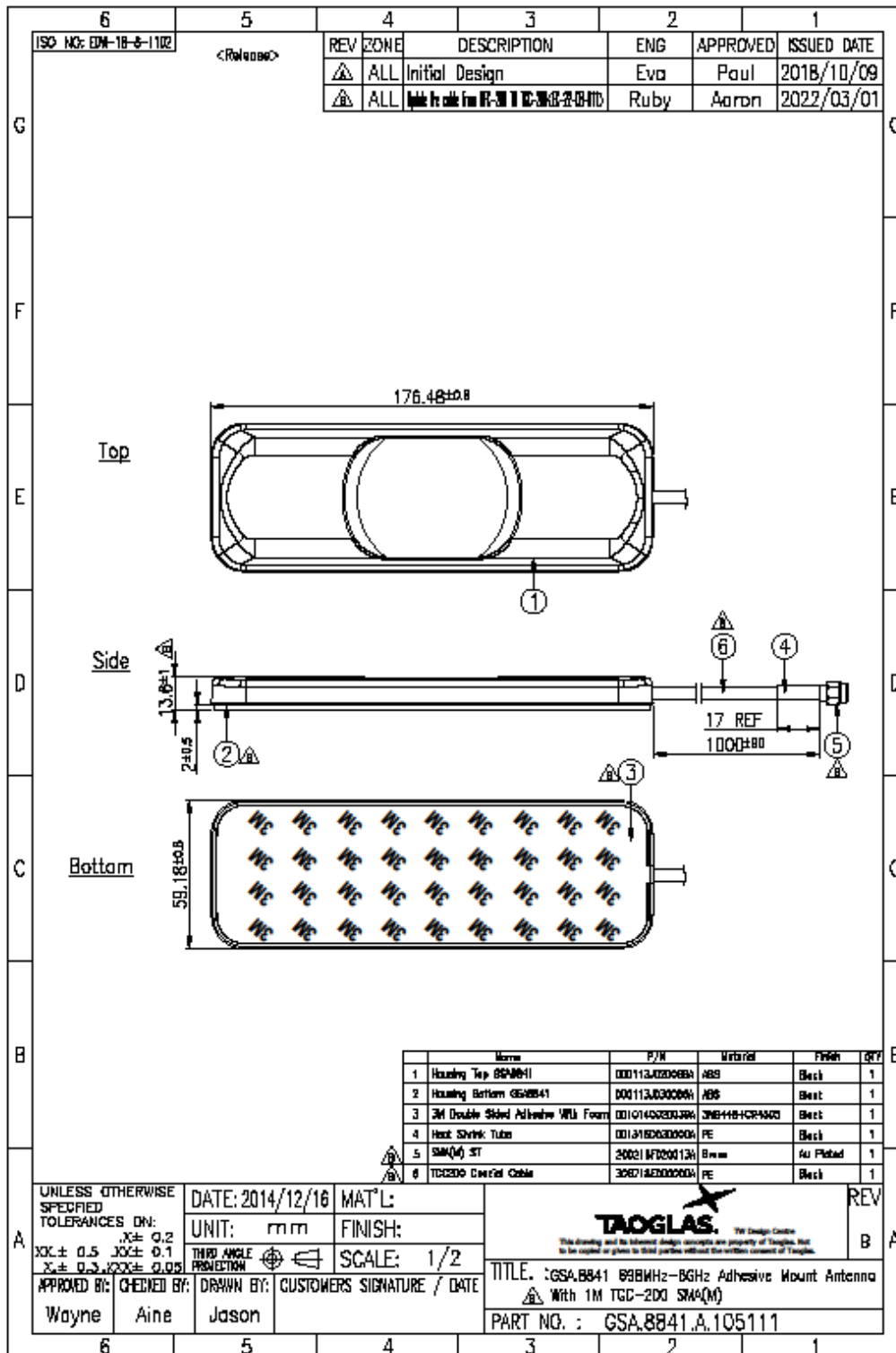

6. Packaging

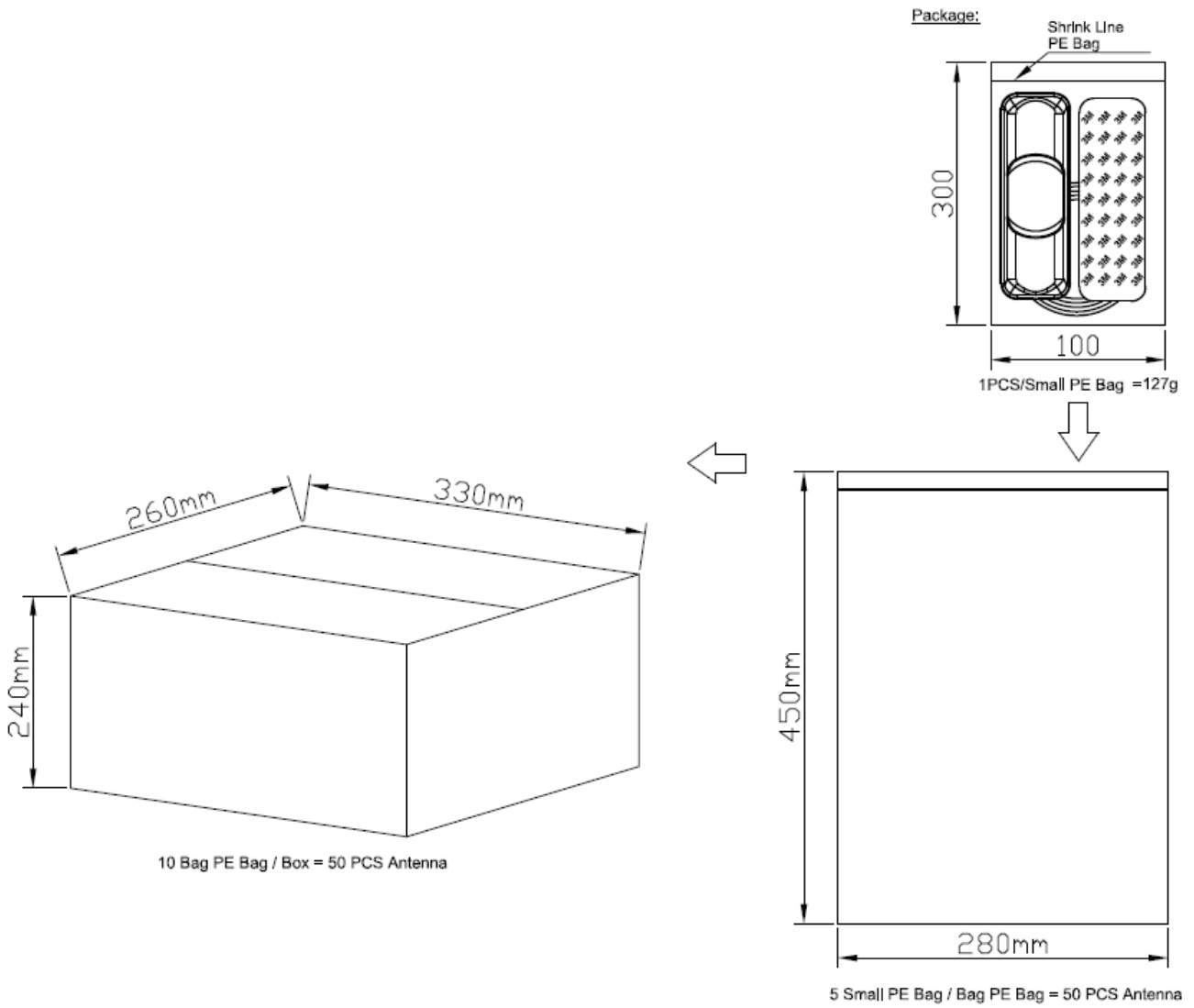

7. Application Note

The GSA.8841 antenna measurement with difference cable length and difference environments, the performance is shown as below,

7.1 Return Loss – Free Space

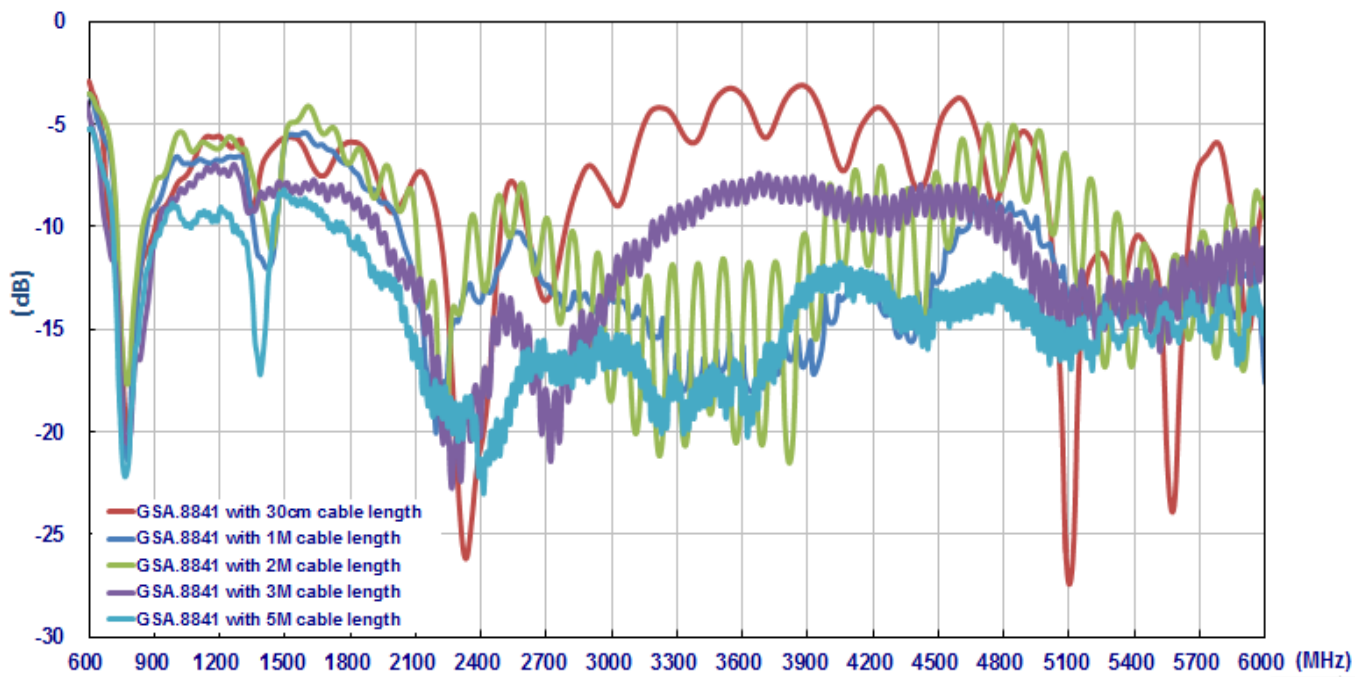

7.2 Efficiency – Free Space

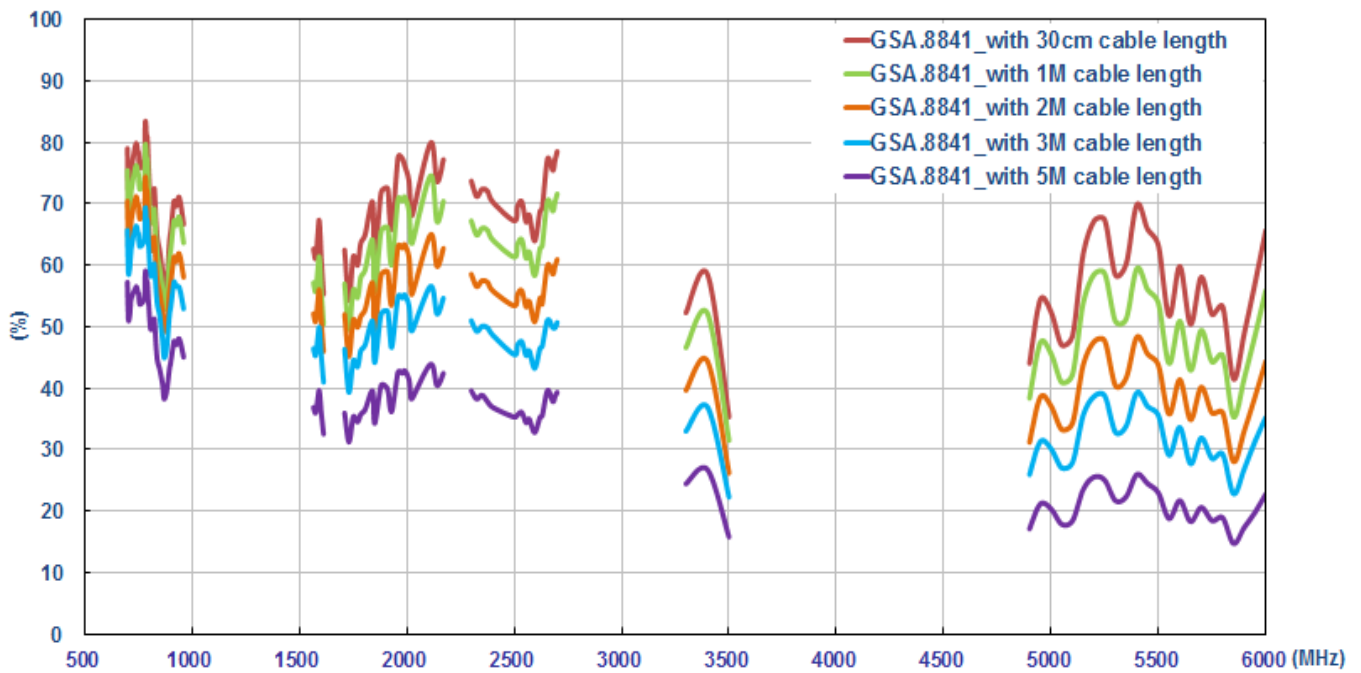

7.3 Average gain – Free Space

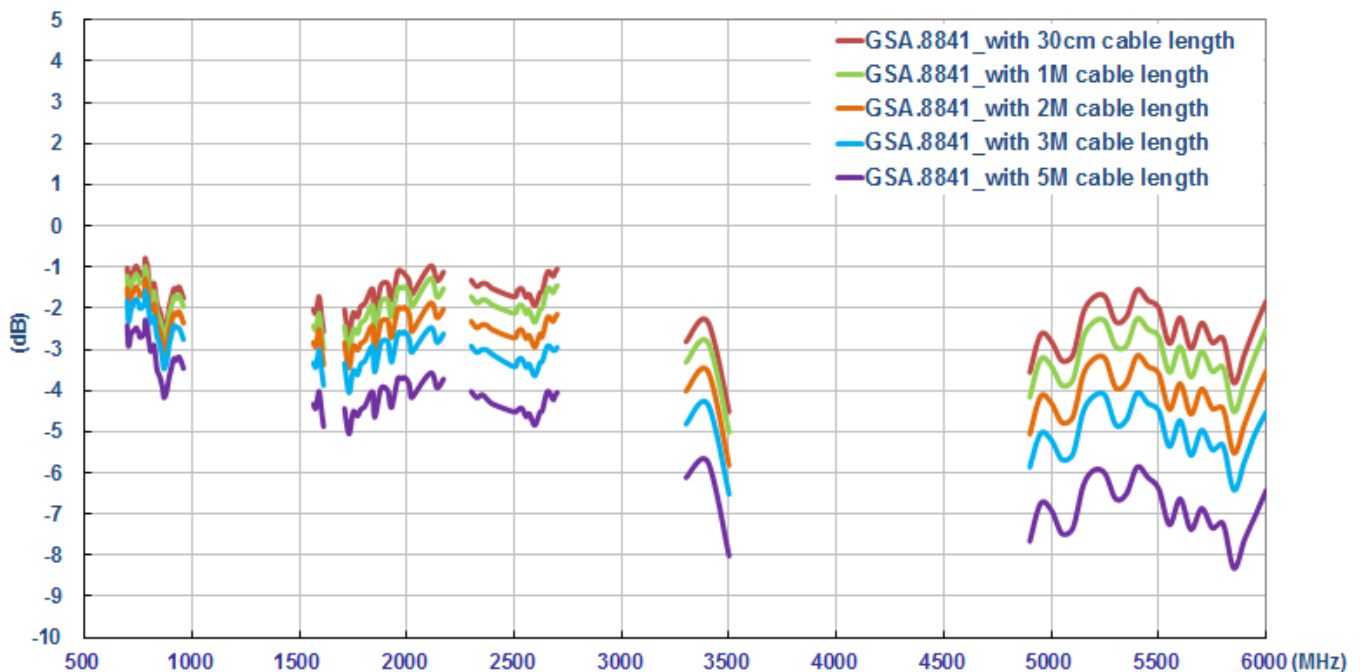

7.4 Peak gain – Free space

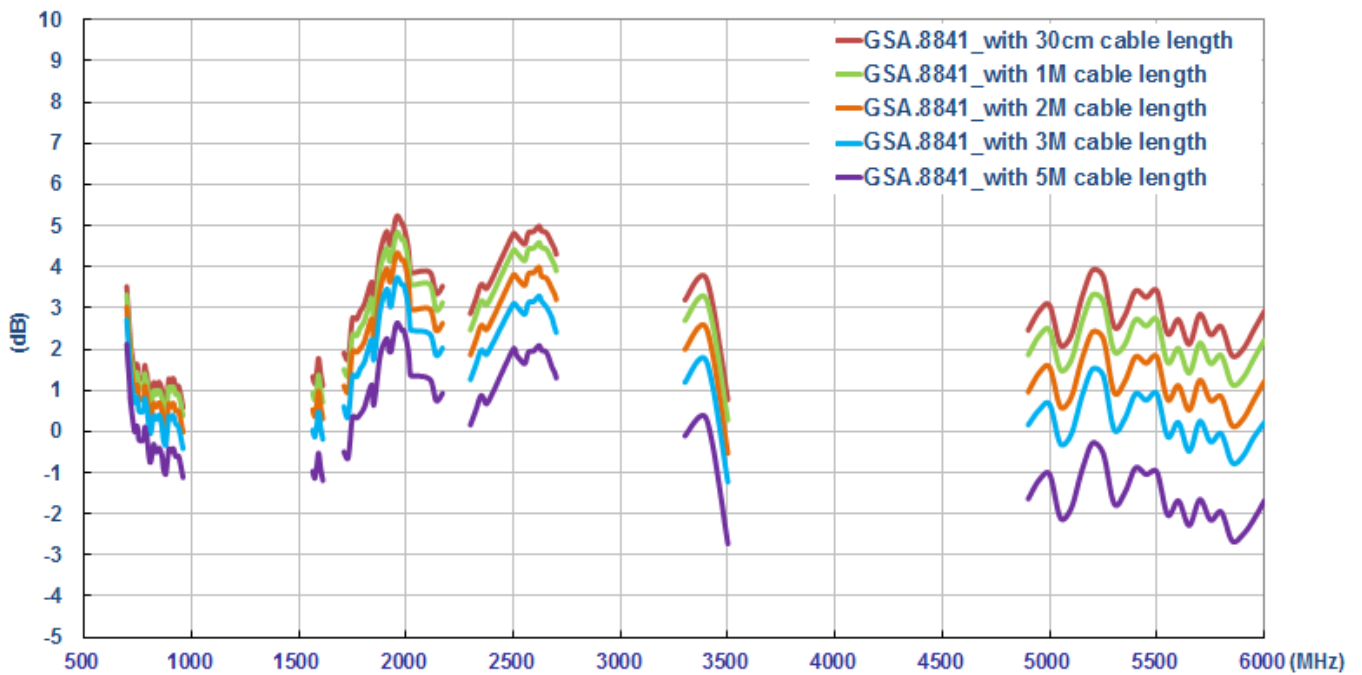

7.5 Return loss – 2mm ABS

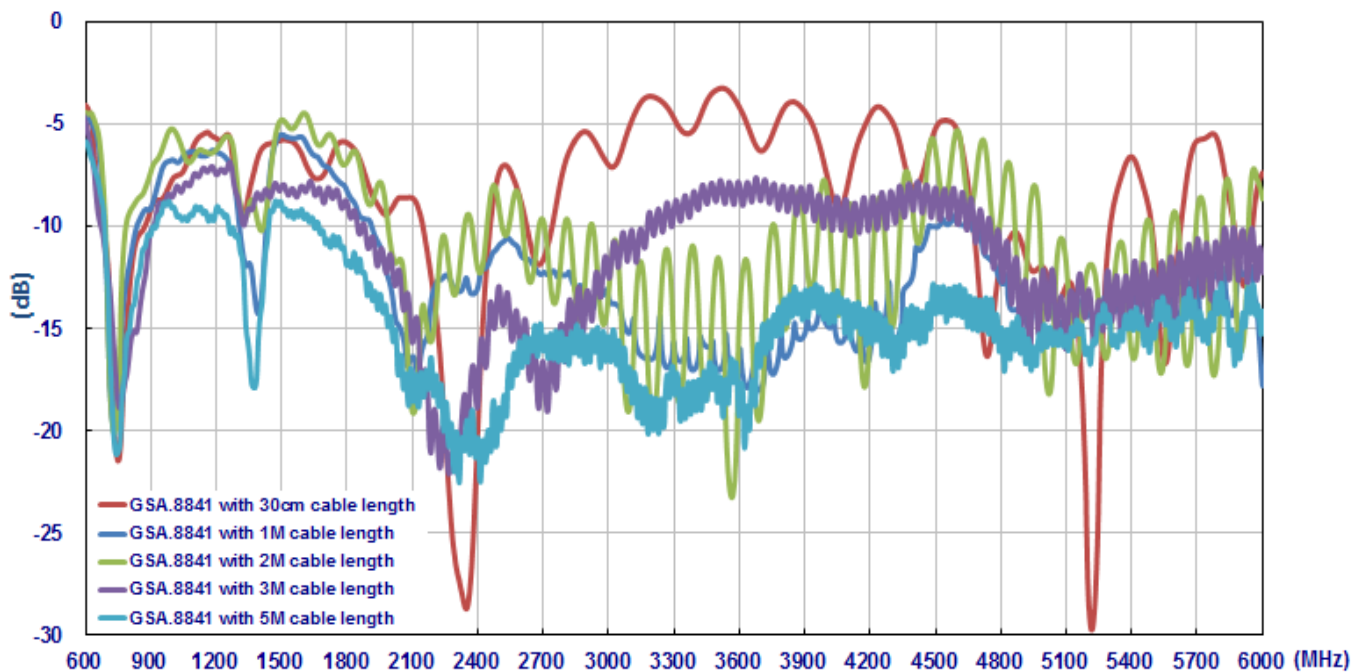

7.6 Efficiency – 2mm ABS

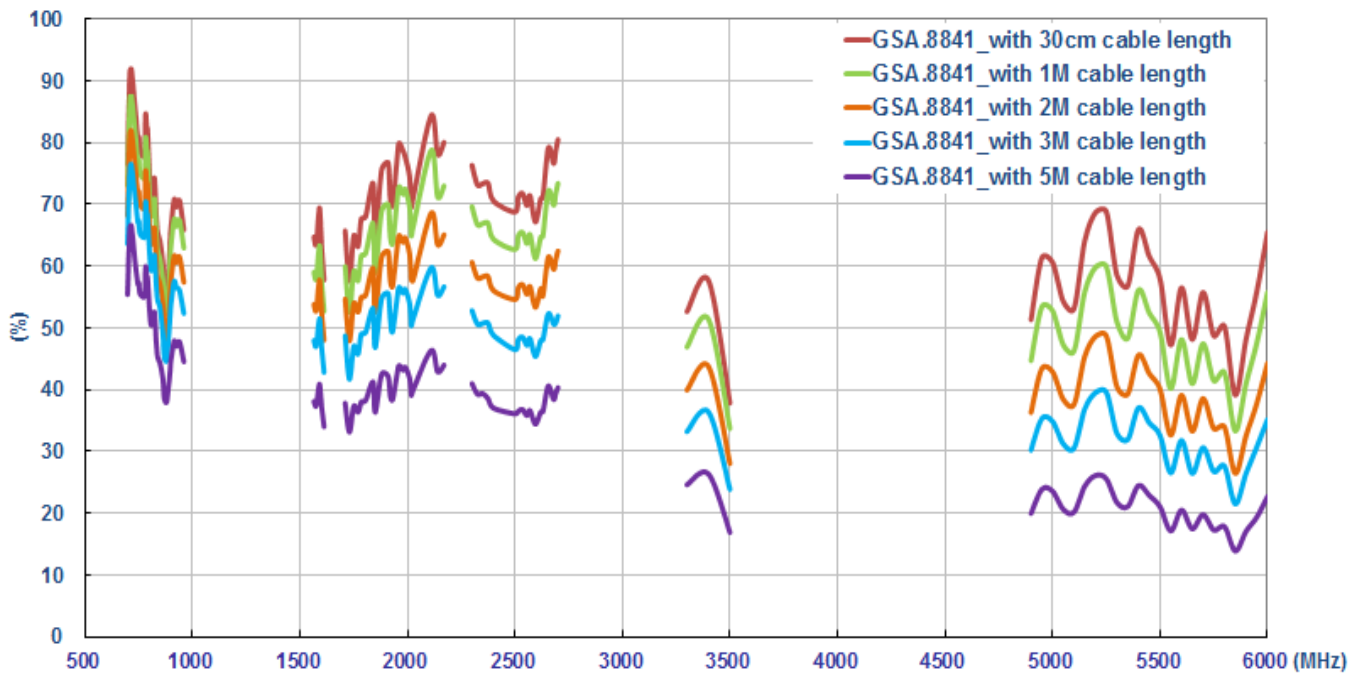

7.7 Average gain – 2mm ABS

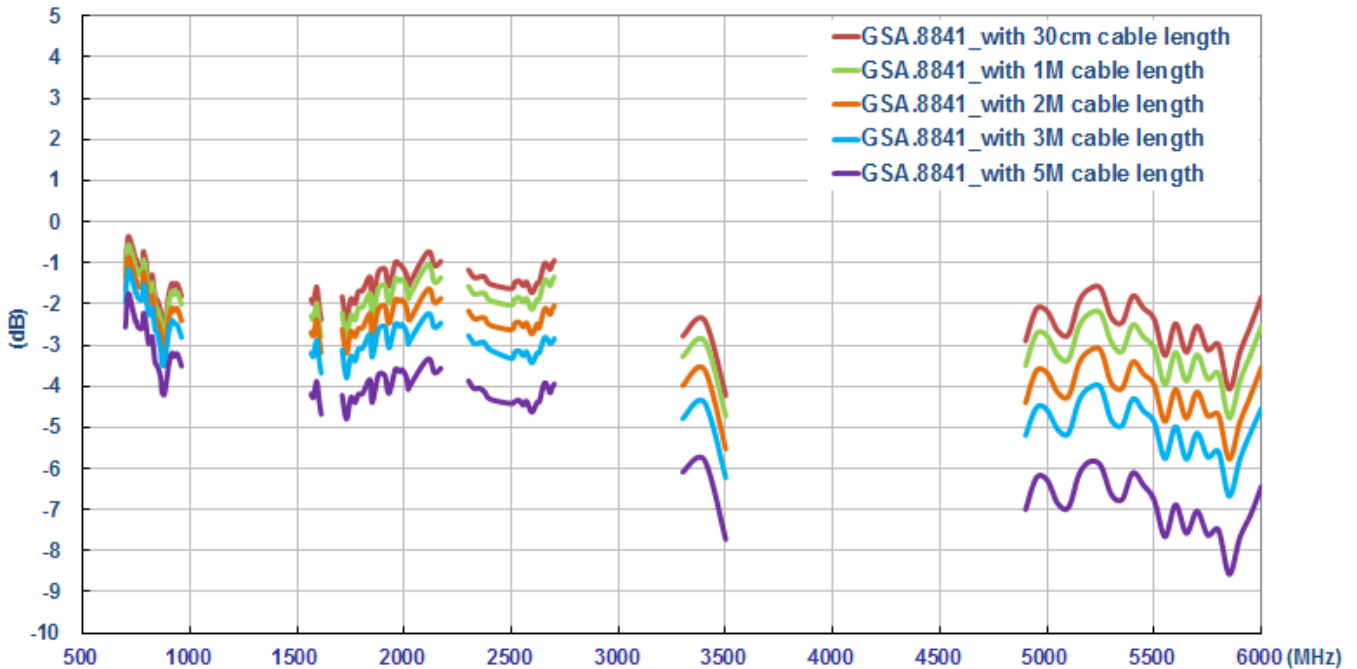

7.8 Peak gain – 2mm ABS

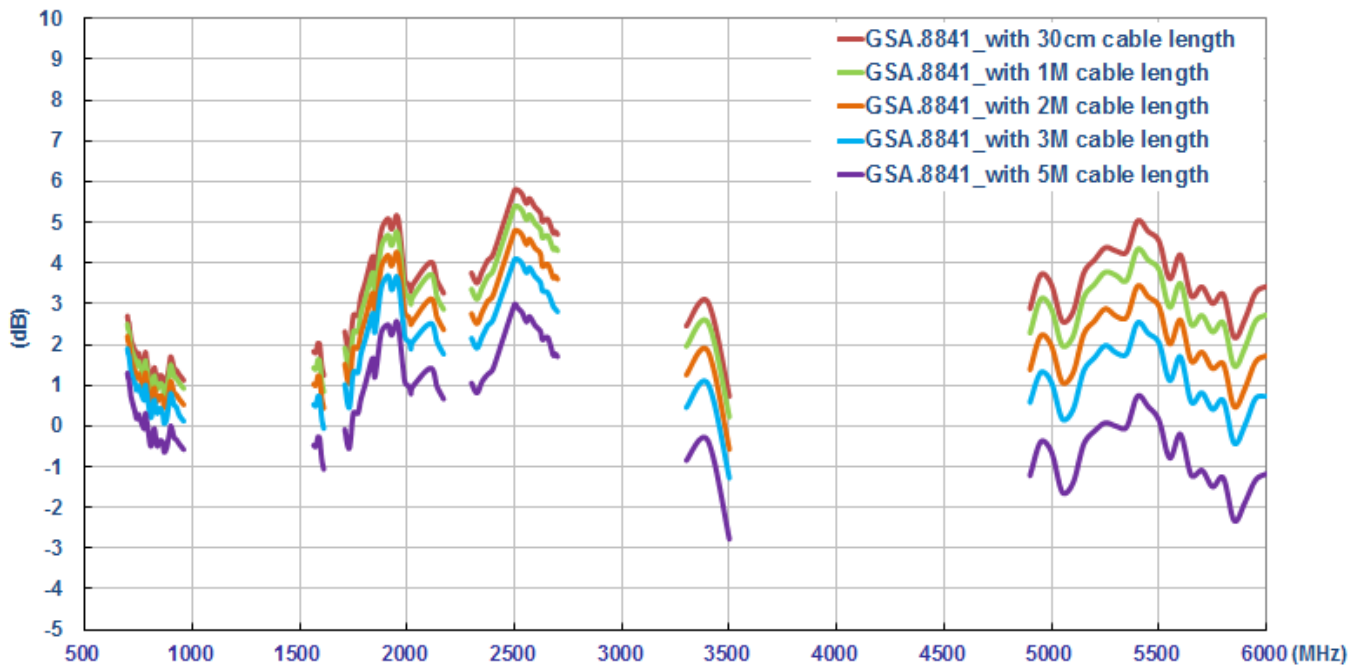

7.9 Return loss – Glass

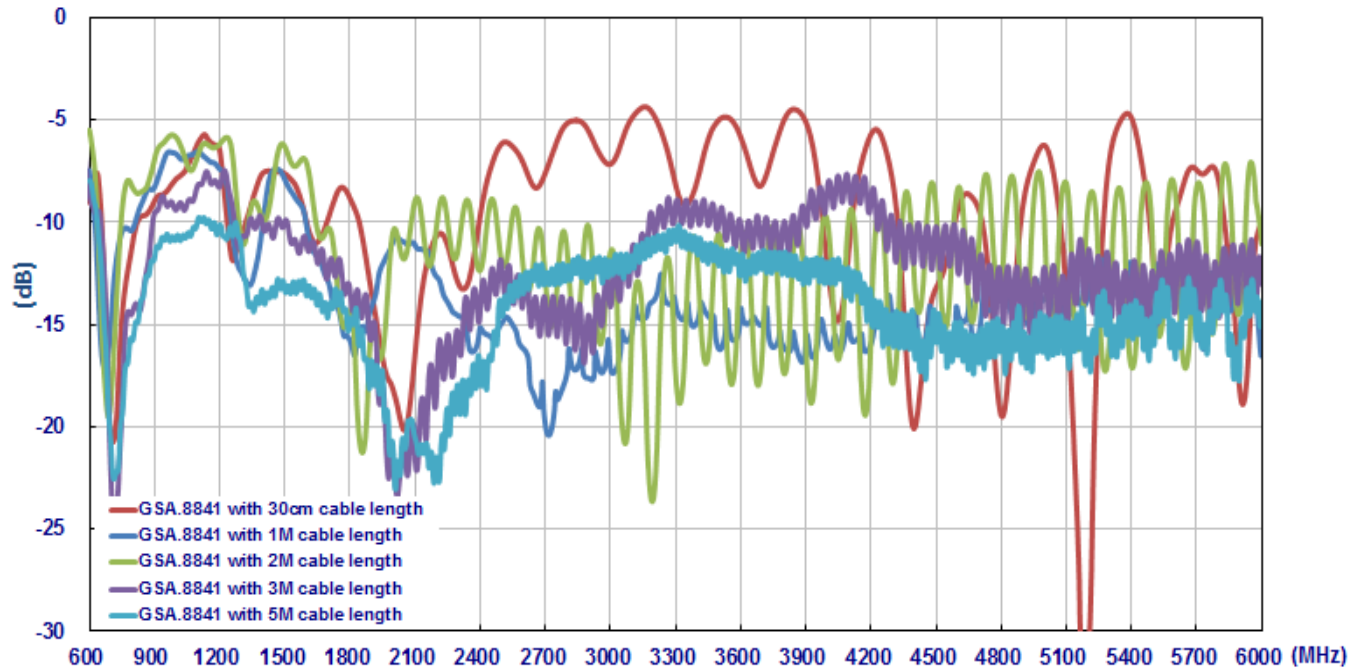

7.10 Efficiency – Glass

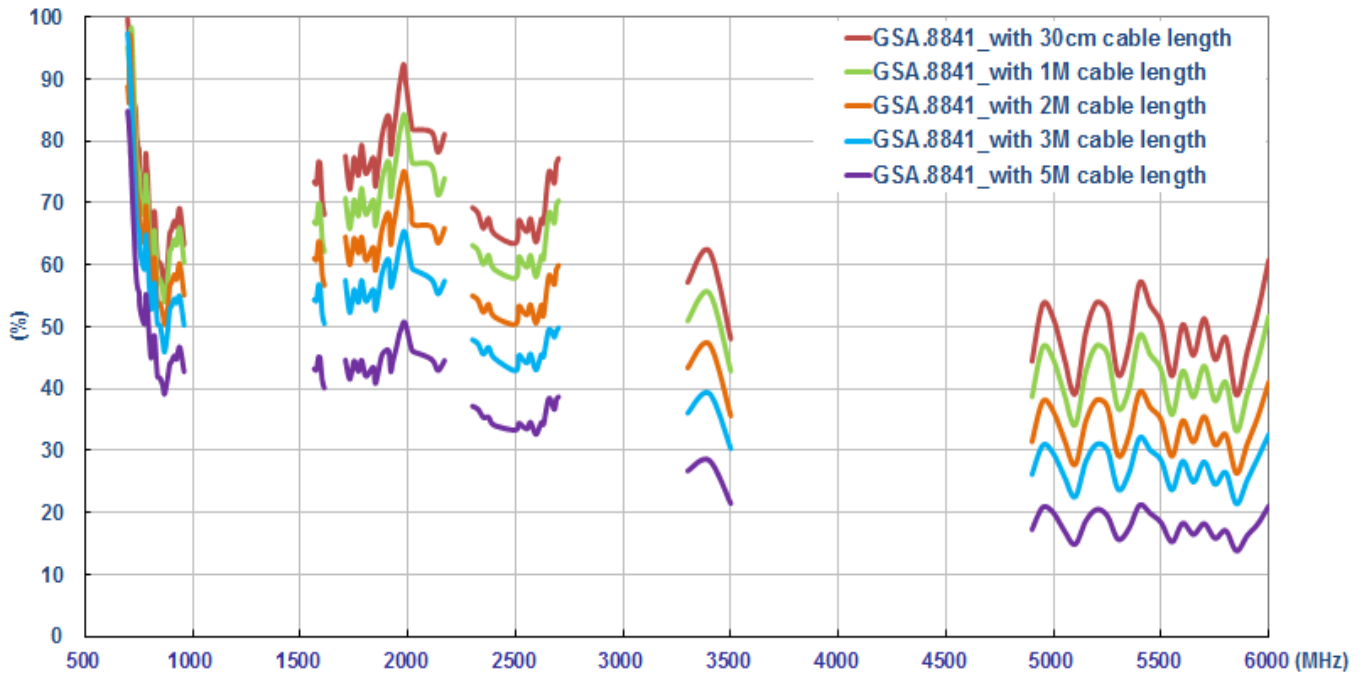

7.11 Average gain – Glass

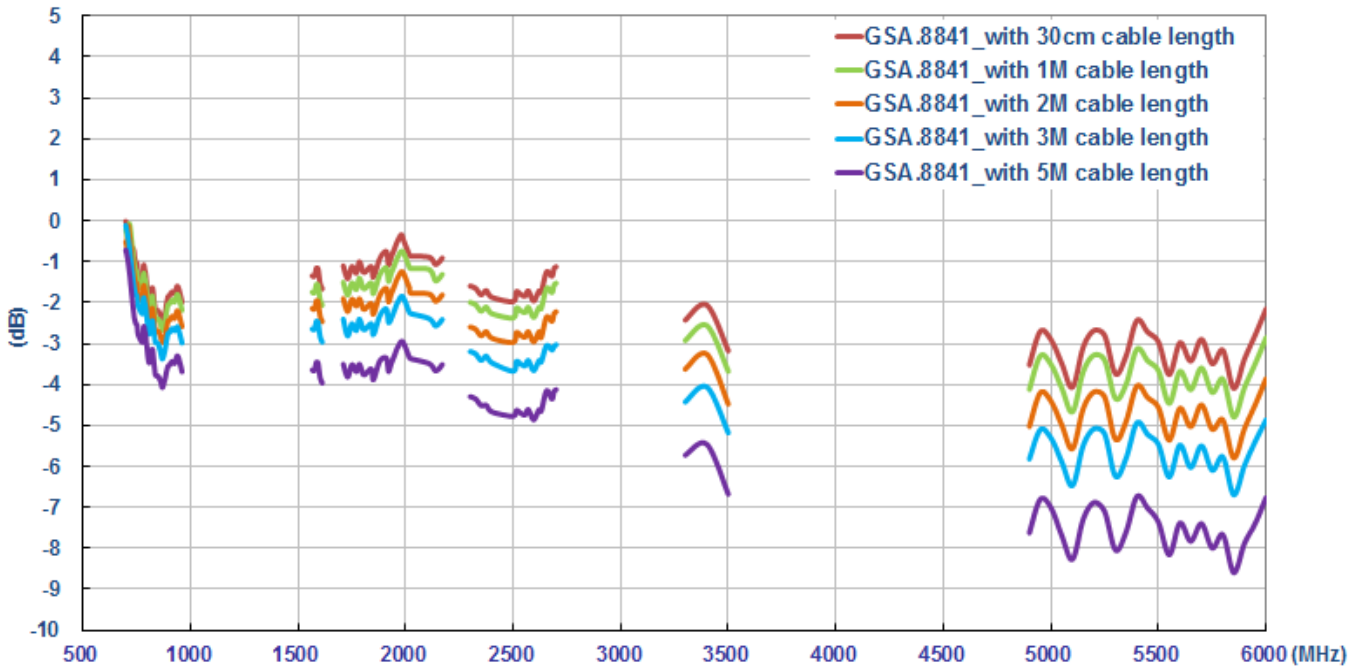

7.12 Peak gain – Glass

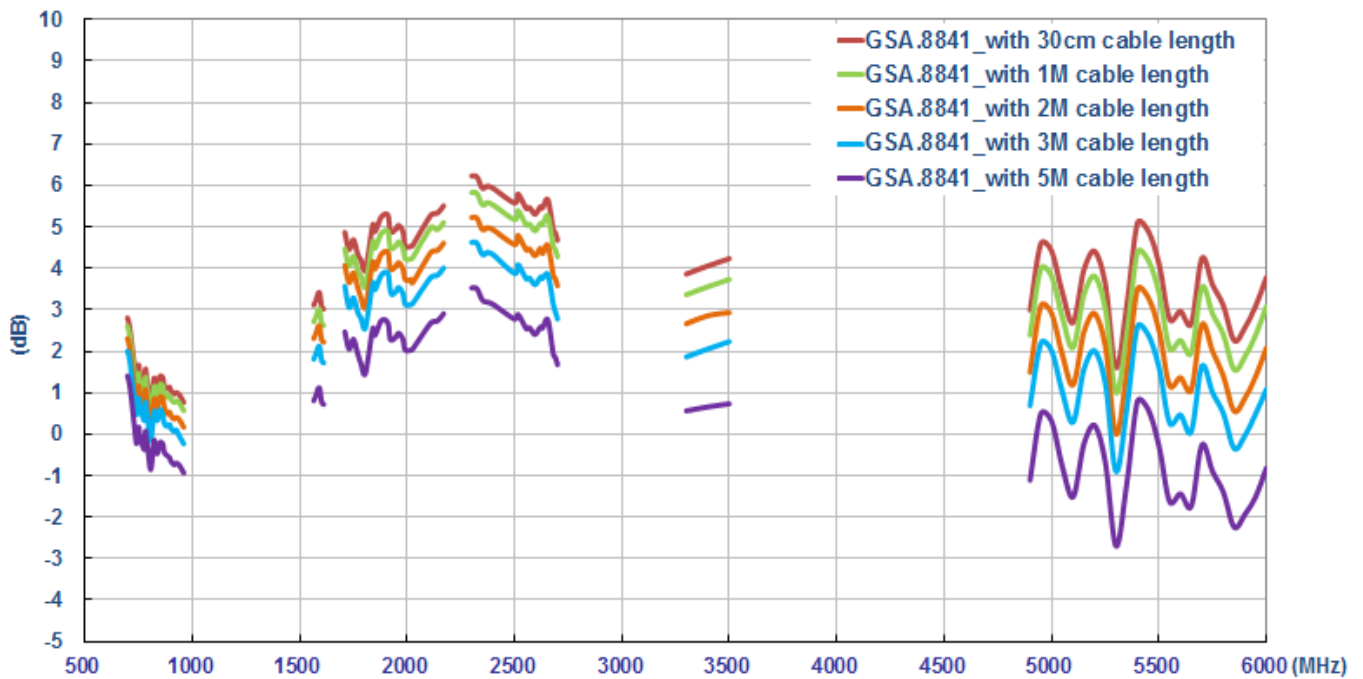

Taoglas makes no warranties based on the accuracy or completeness of the contents of this document and reserves the right to make changes to specifications and product descriptions at any time without notice. Taoglas reserves all rights to this document and the information contained herein.

Reproduction, use or disclosure to third parties without express permission is strictly prohibited.

Copyright © Taoglas Ltd.

Changelog for the datasheet

SPE-14-8-062 – GSA.8841.A.105111

Revision: D (Current Version)

Date:	2022-06-08
Changes:	Updated Image and Drawing
Changes Made by:	Cesar Sousa

Previous Revisions

Revision: C

Date:	2021-10-26
Changes:	Removed IP Rating
Changes Made by:	Gary West

Revision: B

Date:	2017-04-04
Changes:	Added LTE Band Table
Changes Made by:	Peter Monahan

Revision: A (Original First Release)

Date:	2014-06-20
Notes:	
Author:	David Connolly