



# TAOGLAS®



## Datasheet

### Adhesive LTE Antenna

**Part No:**  
GSA.8845.A.105111

**Description:**

Wideband 4G/3G/2G LTE Adhesive Mount I-Bar Antenna 1M TGC-200 SMA(M)

**Features:**

5G/4G/ Wi-Fi, Adhesive Mount Antenna

450-470MHz, 698-960MHz 1710-2700MHz, 4900-5850MHz

Cable: 1M TGC-200

Connector: SMA(M)

Dimension 176mm \* 59mm \* 11.6mm

RoHS & Reach Compliant

1. Introduction	3
2. Specifications	4
3. Antenna Characteristics	6
4. 2D Radiation Patterns	10
5. 3D Radiation Patterns	17
6. Mechanical Drawing	22
7. Packaging	23
8. Application Note	24
<hr/>	
Changelog	30

Taoglas makes no warranties based on the accuracy or completeness of the contents of this document and reserves the right to make changes to specifications and product descriptions at any time without notice. Taoglas reserves all rights to this document and the information contained herein.

Reproduction, use or disclosure to third parties without express permission is strictly prohibited.

Copyright © Taoglas Ltd.

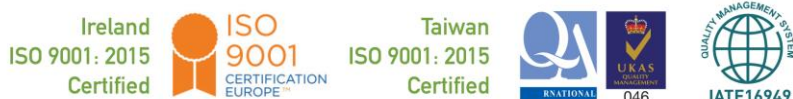

## 1. Introduction



The GSA.8845 Wideband Dipole Antenna has been designed to cover all Cellular, ISM and Wi-Fi working frequencies in the 450-6000 MHz spectrum. It has the highest wide-band efficiency in its range of any terminal antenna on the market today.

The GSA.8845 has been primarily designed for use with 4G LTE modules and devices that require the highest possible efficiency and peak gain to deliver best in class throughput on all major cellular (4G/3G/2G) bands worldwide, vital for applications such as high speed video and real-time streaming, or high capacity MIMO networks on public transportation.

It comes with 1-meter coaxial cable and SMA (M) connector, in a low profile compact format for mounting via high quality first tier automotive approved 3M adhesive foam.

The GSA.8845 exhibits high efficiency and is backward compatible with 3G and 2G cellular applications such as GSM, LTE, UMTS, Wi-Fi.

It is an ideal solution for any device requiring high, reliable performance. It is also guaranteed to meet any type approval or carrier certification requirements from an efficiency standpoint. The antenna also makes an excellent reference antenna for test purposes. It has been designed as an omnidirectional antenna, as can be seen in the radiation patterns, which is stable across all bands.

Contact your regional customer support team for further information.

## 2. Specifications

Electrical											
Standard	LTE 450	LTE 700	GSM 850	GSM 900	DCS	PCS	UMTS1	LTE 2600	C-Band	WIFI 5G	
Frequency (MHz)	450~470	698~806	824~894	880~960	1710~1880	1850~1990	1920~2170	2300~2690	3400~3800	4900~5850	
Efficiency (%)											
In free space	0.3M	54.59	68.84	76.00	63.84	71.41	60.60	66.79	74.19		62.65
	1M	52.14	65.27	72.56	60.97	65.15	55.27	61.44	67.65	29.12	53.79
	2M	48.66	60.91	66.66	55.61	58.06	48.66	53.84	58.57		43.57
	3M	46.47	56.34	61.76	51.59	51.62	43.04	47.59	50.96		35.29
	5M	41.42	48.67	52.57	43.62	40.68	33.74	37.06	38.51		23.13
On 2mm ABS Base	0.3M	35.95	68.97	66.19	56.81	61.27	56.23	59.11	59.92		59.13
	1M	34.34	65.24	63.20	54.25	55.89	51.26	54.34	54.64	33.6	50.80
	2M	32.05	60.88	58.05	49.48	49.81	45.13	47.62	47.33		41.16
	3M	30.61	56.40	53.79	45.90	44.29	39.90	42.10	41.20		33.36
	5M	27.28	48.74	45.78	38.81	34.91	31.30	32.80	31.13		21.88
On Glass Base	0.3M	19.55	67.74	62.39	53.07	66.77	66.14	67.56	57.39		49.94
	1M	18.67	64.00	59.59	50.71	60.90	60.30	62.12	52.35	37.6	42.92
	2M	17.42	59.72	54.72	46.25	54.28	53.08	54.43	45.38		34.76
	3M	16.64	55.36	50.72	42.94	48.25	46.93	48.12	39.52		28.18
	5M	14.83	47.88	43.17	36.30	38.04	36.82	37.50	29.88		18.48
Average Gain(dBi)											
In free space	0.3M	-2.70	-1.78	-1.21	-1.96	-1.46	-2.20	-1.80	-1.32		-2.10
	1M	-2.90	-2.02	-1.41	-2.16	-1.86	-2.60	-2.17	-1.72	-4.96	-2.76
	2M	-3.20	-2.32	-1.78	-2.56	-2.36	-3.16	-2.74	-2.34		-3.67
	3M	-3.40	-2.65	-2.11	-2.89	-2.87	-3.69	-3.27	-2.95		-4.58
	5M	-3.90	-3.28	-2.81	-3.62	-3.91	-4.74	-4.36	-4.17		-6.41
On 2mm ABS Base	0.3M	-4.54	-1.63	-1.80	-2.46	-2.13	-2.51	-2.30	-2.25		-2.31
	1M	-4.74	-1.87	-2.00	-2.66	-2.53	-2.91	-2.66	-2.65	-4.84	-2.97
	2M	-5.04	-2.17	-2.37	-3.06	-3.03	-3.46	-3.24	-3.27		-3.88
	3M	-5.24	-2.50	-2.70	-3.39	-3.54	-4.00	-3.77	-3.88		-4.79
	5M	-5.74	-3.13	-3.40	-4.12	-4.58	-5.05	-4.86	-5.10		-6.62
On the Glass Base	0.3M	-7.63	-1.70	-2.05	-2.82	-1.76	-1.80	-1.71	-2.47		-3.04
	1M	-7.83	-1.95	-2.25	-3.02	-2.16	-2.20	-2.07	-2.87	-4.28	-3.69
	2M	-8.13	-2.25	-2.62	-3.42	-2.66	-2.76	-2.65	-3.50		-4.61
	3M	-8.33	-2.58	-2.95	-3.75	-3.17	-3.29	-3.18	-4.10		-5.52
	5M	-8.83	-3.21	-3.65	-4.47	-4.20	-4.34	-4.27	-5.32		-7.35

Peak Gain(dBi)											
Standard	LTE 450	LTE 700	GSM 850	GSM 900	DCS	PCS	UMTS1	LTE 2600	C-Band	WIFI 5G	
Frequency (MHz)	450~470	698~806	824~894	880~960	1710~1880	1850~1990	1920~2170	2300~2690	3400~3600	4900~5850	
In free space	0.3M	-0.03	2.76	2.85	2.13	2.83	2.71	4.25	3.95		6.02
	1M	-0.23	2.56	2.65	1.93	2.43	2.31	3.85	3.55	0.59	5.32
	2M	-0.53	2.26	2.35	1.53	1.93	1.81	3.35	2.95		4.42
	3M	-0.73	1.86	1.95	1.23	1.43	1.31	2.75	2.25		3.52
	5M	-1.23	1.26	1.25	0.53	0.43	0.21	1.65	1.05		1.72
On 2mm ABS Base	0.3M	-0.76	2.19	2.42	1.66	2.24	2.60	3.65	2.95		5.63
	1M	-0.96	1.99	2.22	1.46	1.84	2.20	3.34	2.55	1.76	4.93
	2M	-1.26	1.69	1.92	1.06	1.34	1.68	2.75	1.95		4.03
	3M	-1.46	1.29	1.52	0.76	0.84	1.10	2.15	1.35		3.13
	5M	-1.25	0.69	0.82	0.06	-0.26	0.10	1.05	0.15		1.33
On Glass Base	0.3M	-1.88	1.73	2.09	1.78	4.94	5.34	5.34	4.51		4.94
	1M	-2.08	1.53	1.89	1.58	4.54	4.94	4.94	4.11	3.22	4.24
	2M	-2.38	1.23	1.59	1.18	4.04	4.40	4.36	3.41		3.34
	3M	-2.58	0.83	1.19	0.88	3.44	3.84	3.84	2.81		2.44
	5M	-1.99	0.23	0.49	0.18	2.44	2.84	2.84	1.51		0.64
Impedance						50Ω					
Polarization						Linear					
Radiation Pattern						Omni					
Input Power						5 W					

Mechanical	
Casing	ABS
Coaxial Cable	TGC-200 Low Loss Cable
Cable Length	1 Meter Standard, Fully Customizable
Connector	SMA Male Standard, Fully Customizable
Adhesive	3M9448+CR4305 Double Sided Adhesive
Weight	127g
Environmental	
Operation Temperature Range	-40°C to 85°C
Storage Temperature Range	-40°C to 85°C
Humidity	Non-condensing 65°C 95% RH

### 3. Antenna Characteristics

#### 3.1 Return Loss

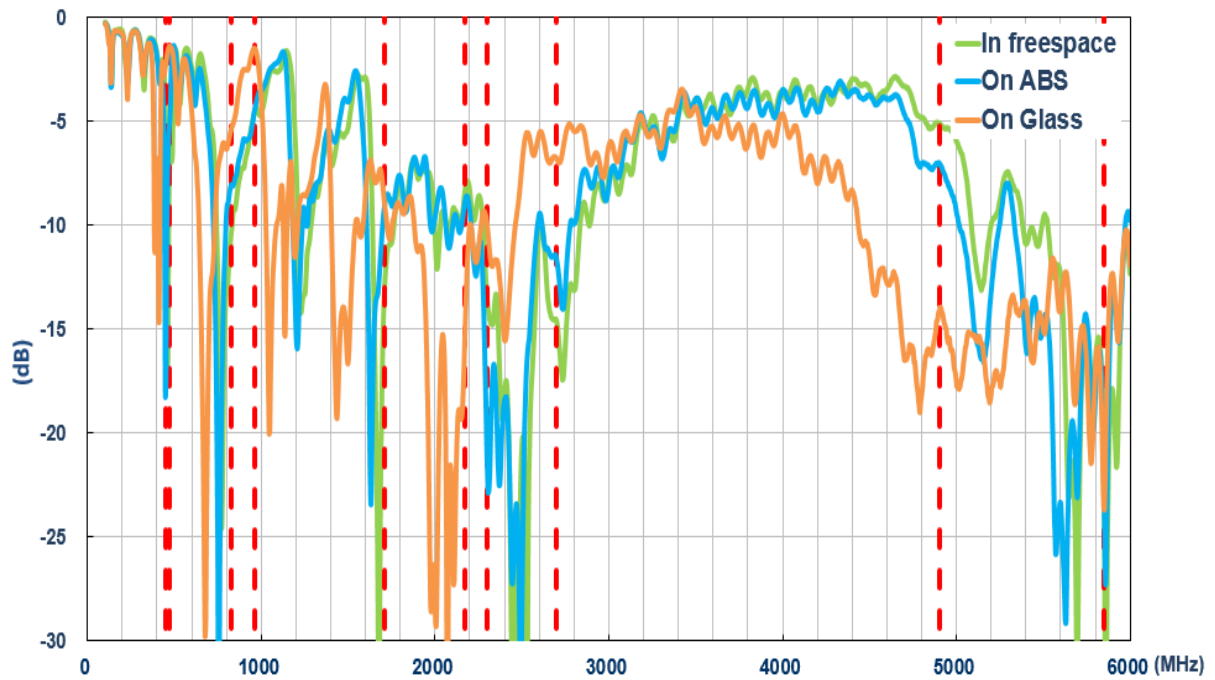

#### 3.2 Efficiency

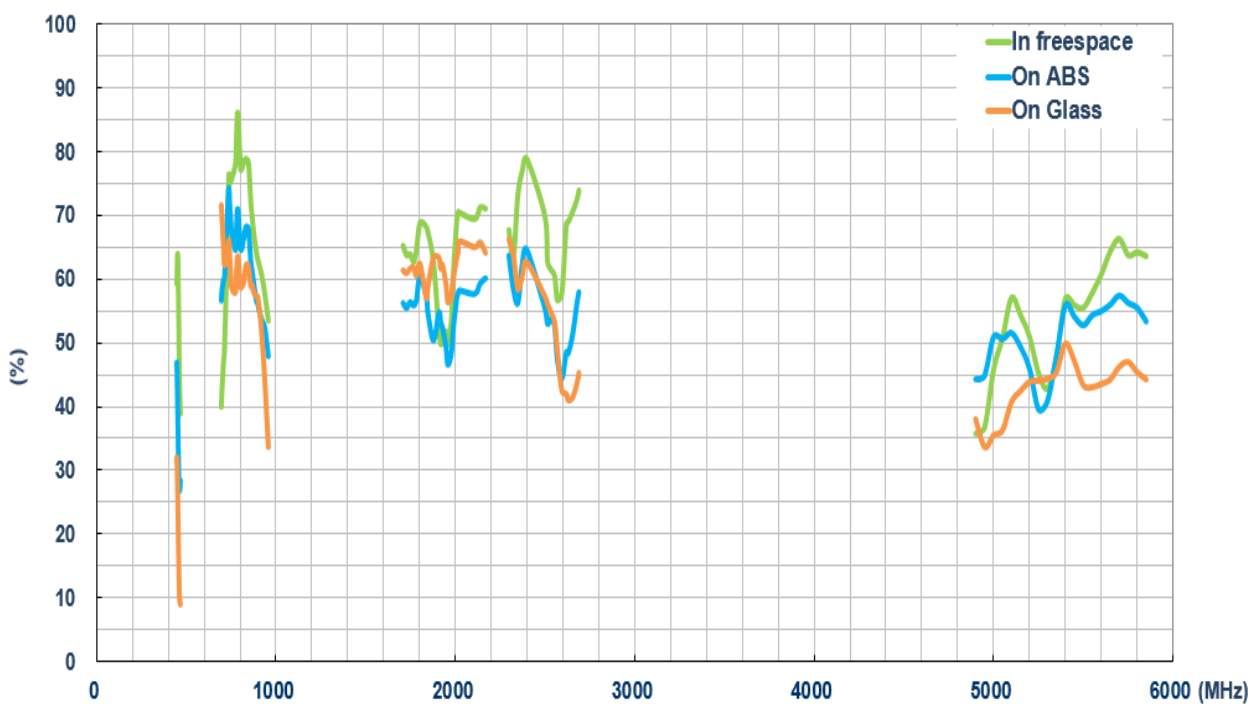

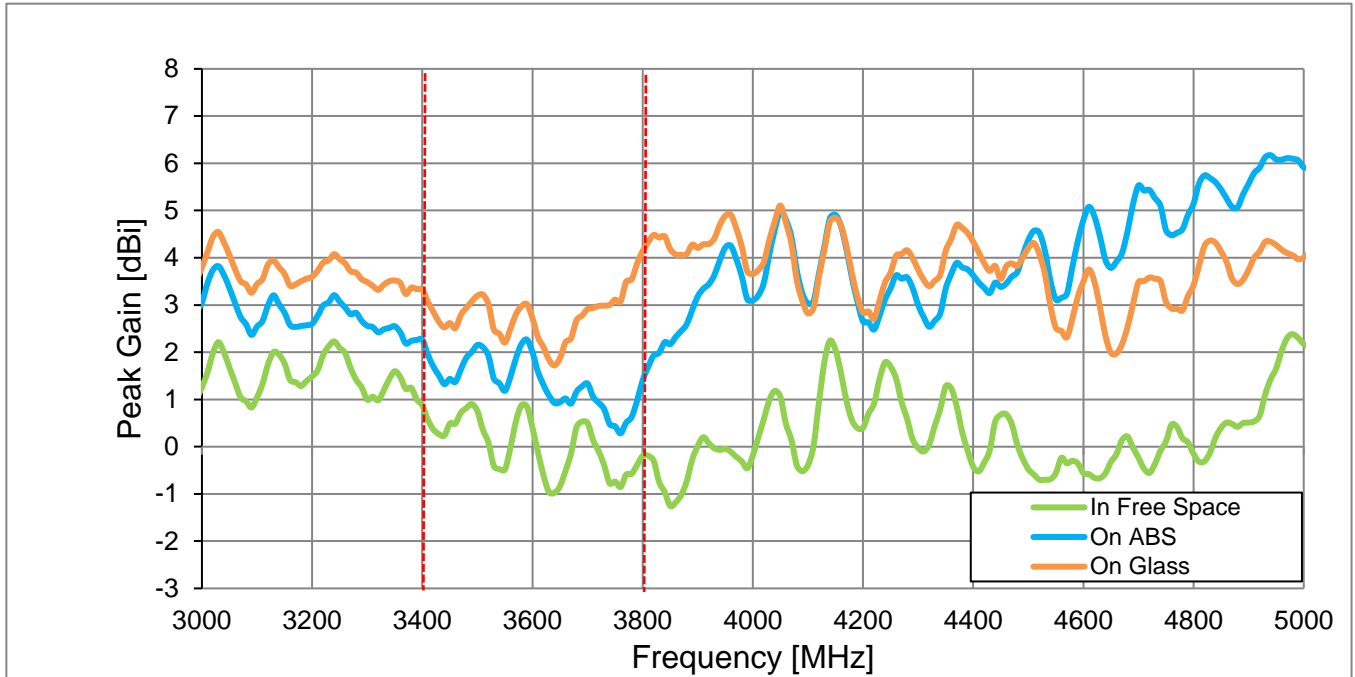

### 3.3 Average Gain

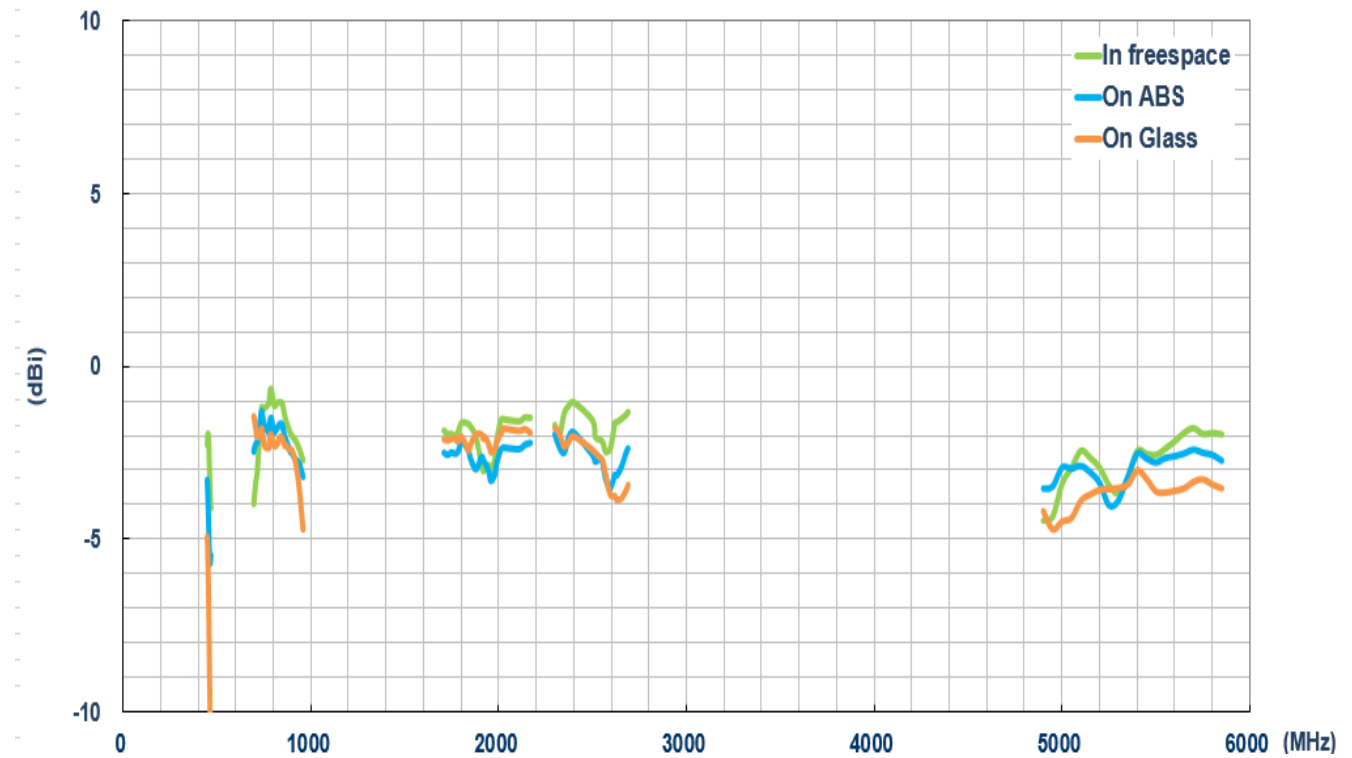

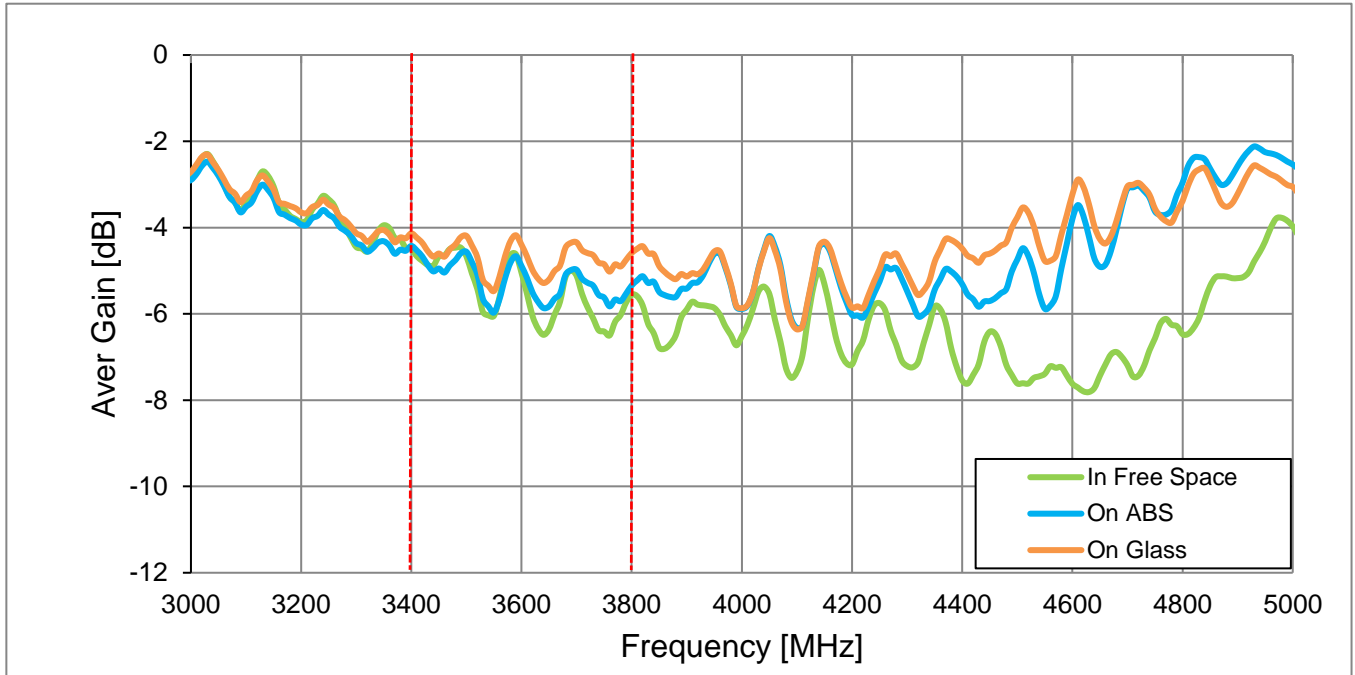

### 3.4 Peak Gain

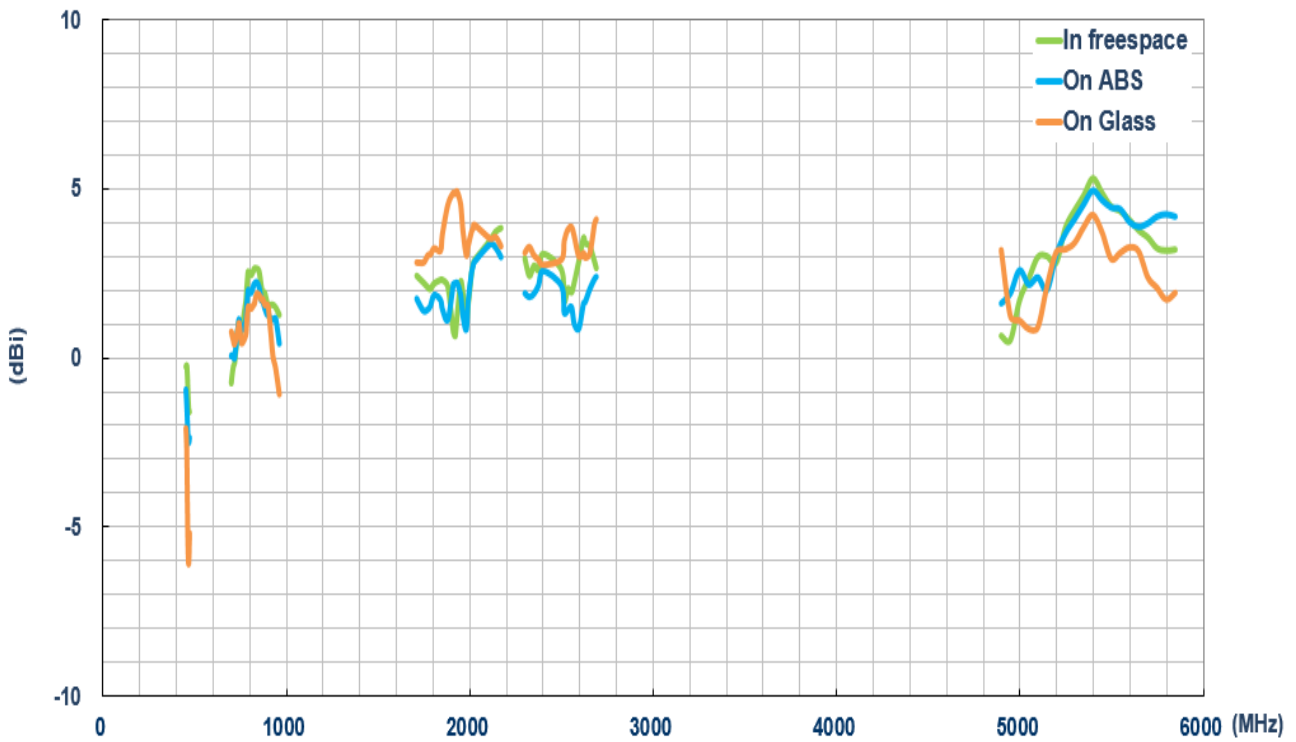



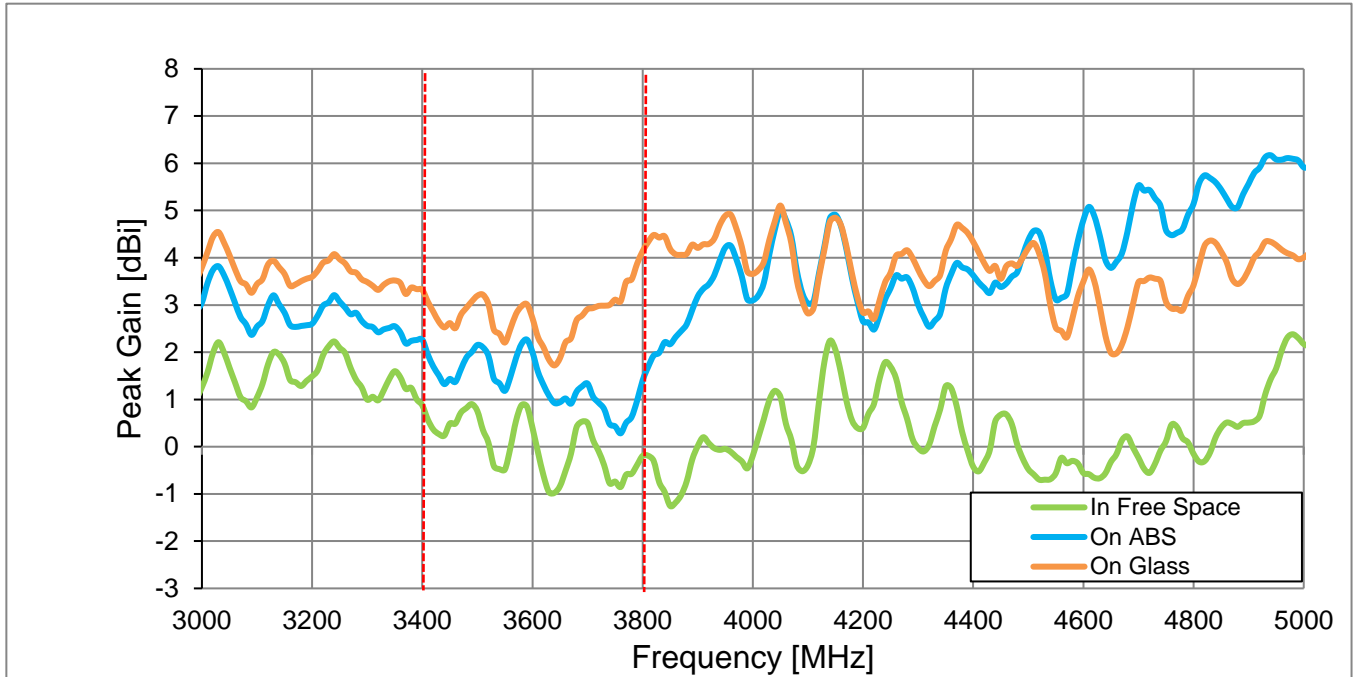

## 4. 2D Radiation Patterns

### 4.1 Test Setup

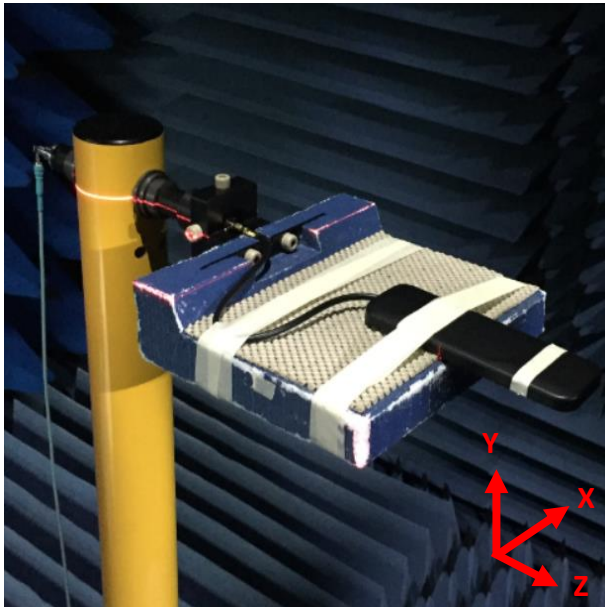

a) In free space



2) On 2mm ABS base

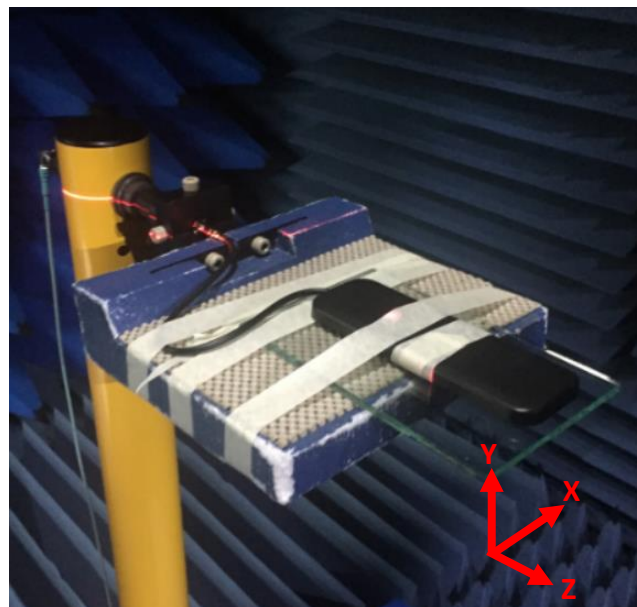

3) On the glass base

## 4.2 Antenna with 1 meter cable length in free space

### XY Plane

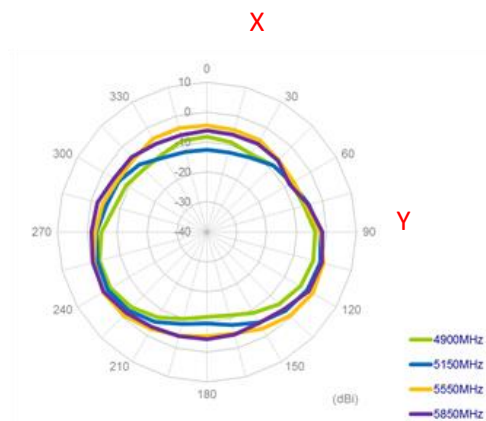
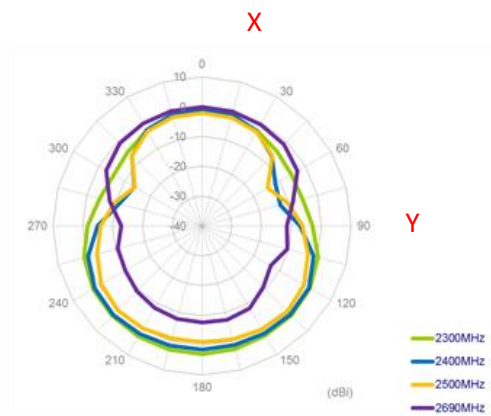
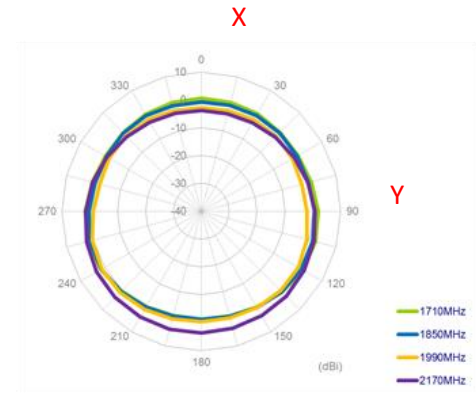
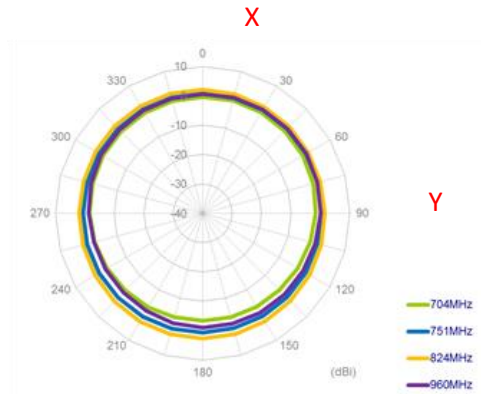
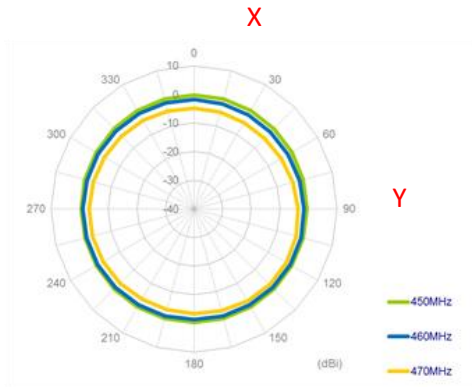

## XZ Plane

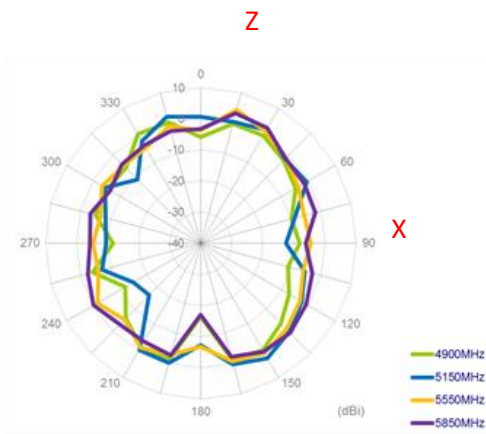
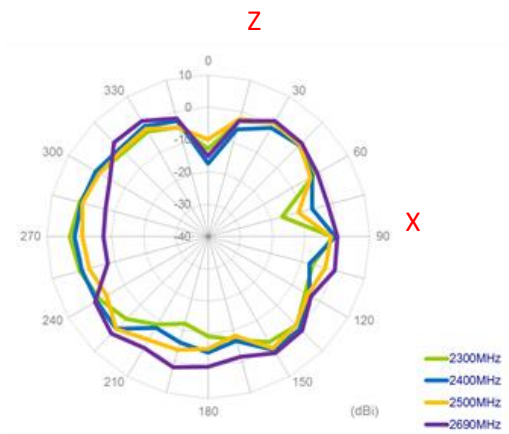
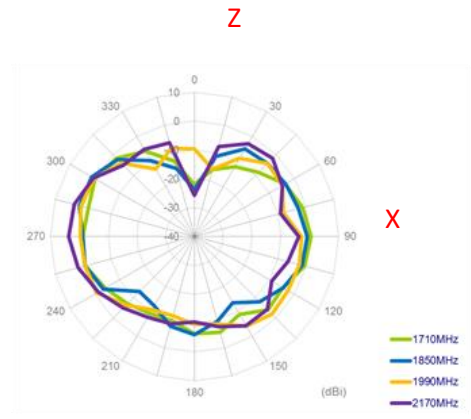
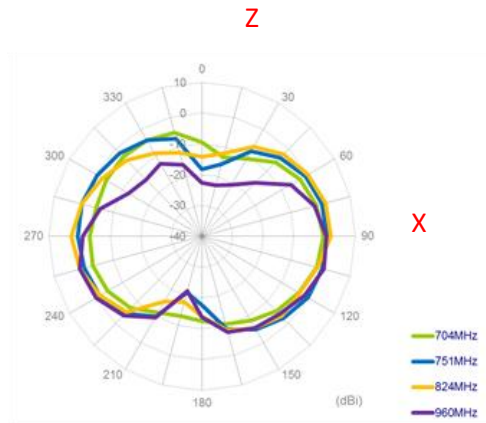
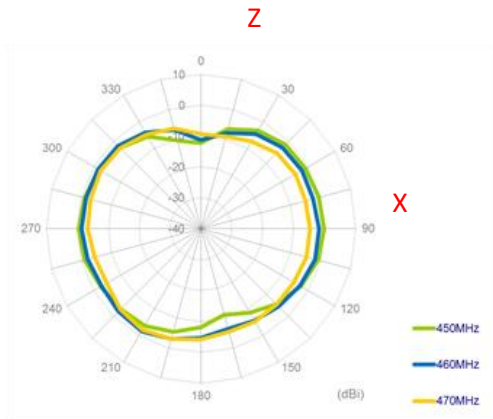

## YZ Plane

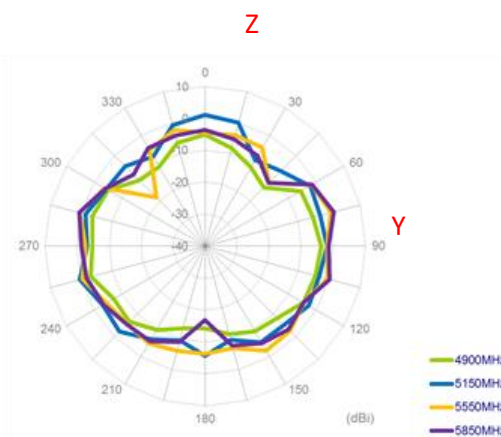
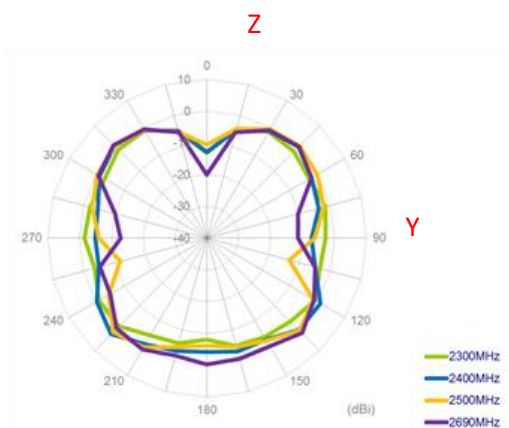
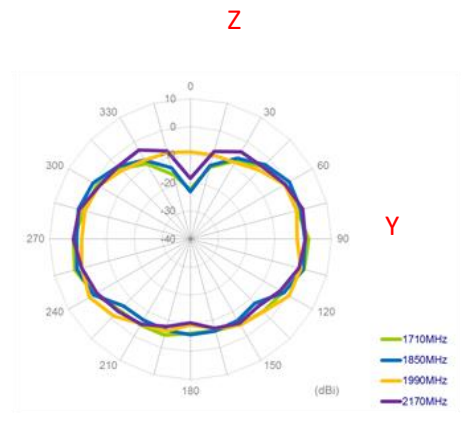
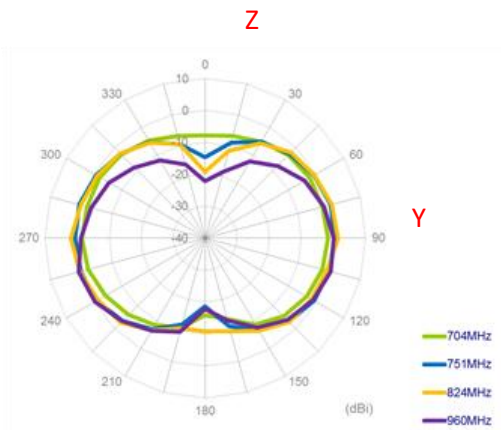
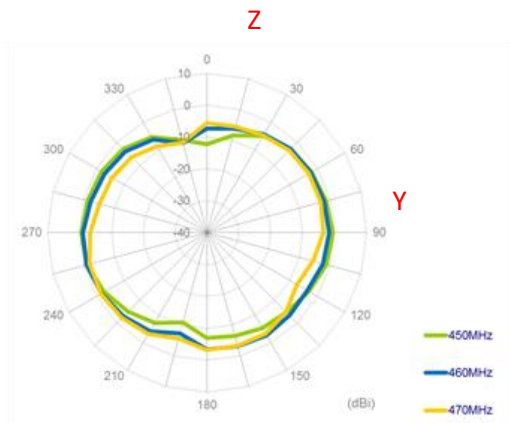

4.3 Antenna with 1 meter cable length on 2mm ABS

XY Plane

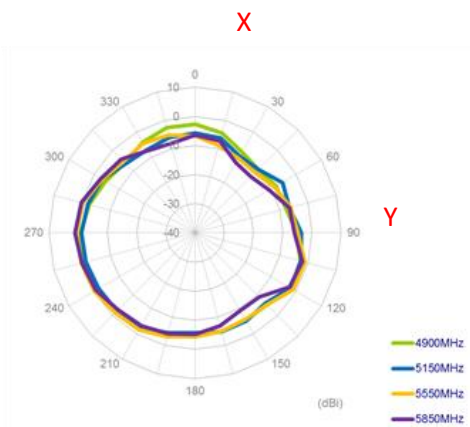
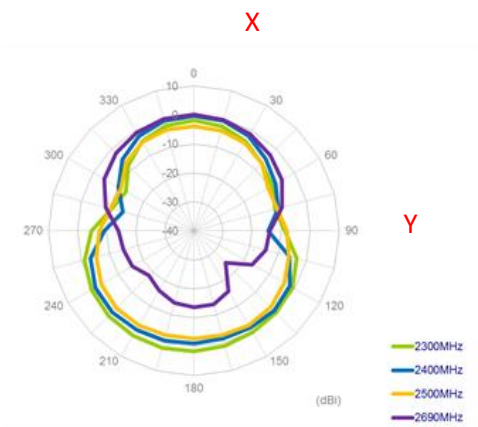
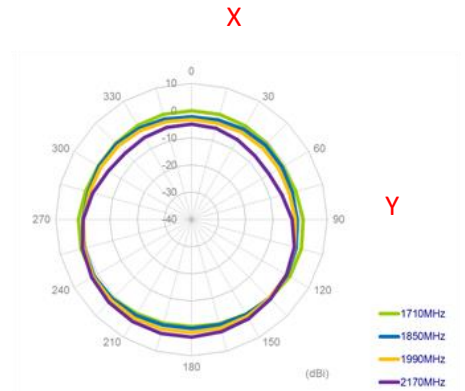
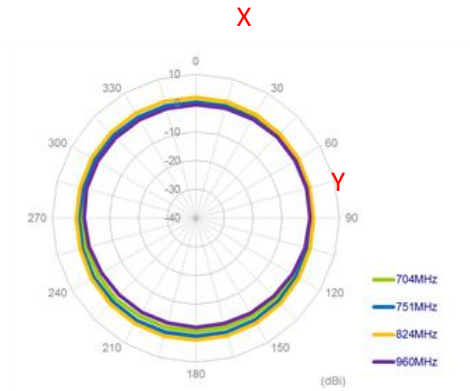
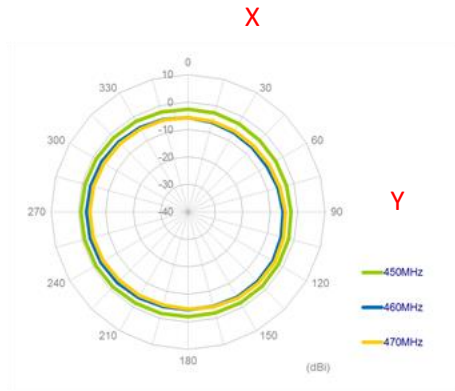

## XZ Plane

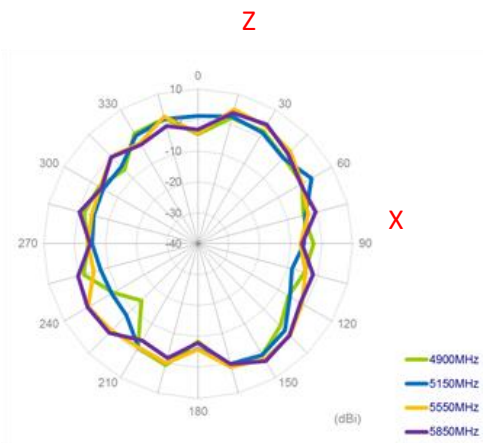
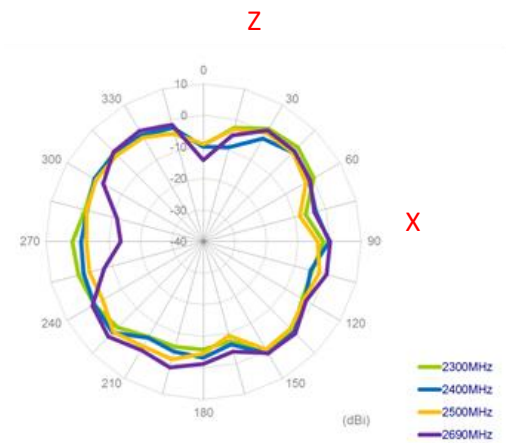
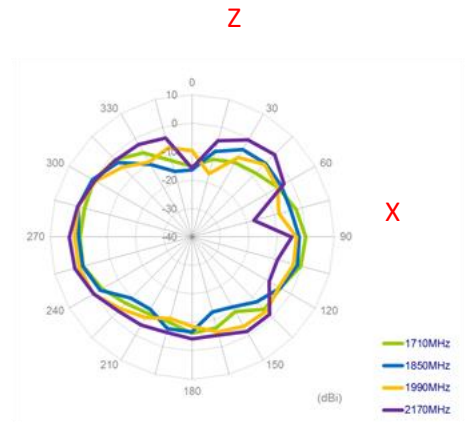
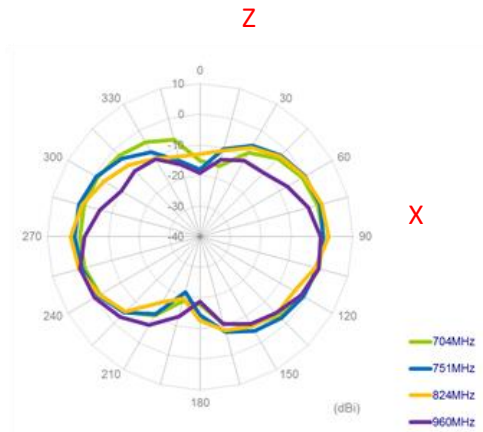
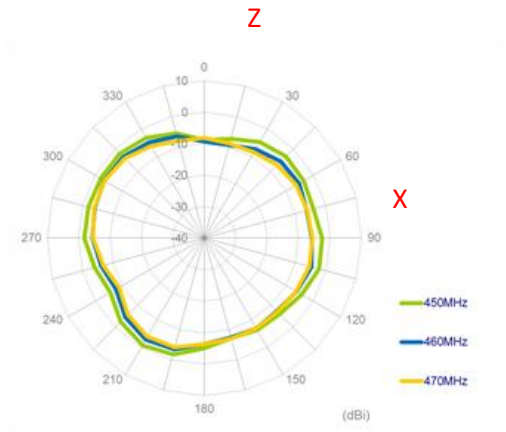

## YZ Plane

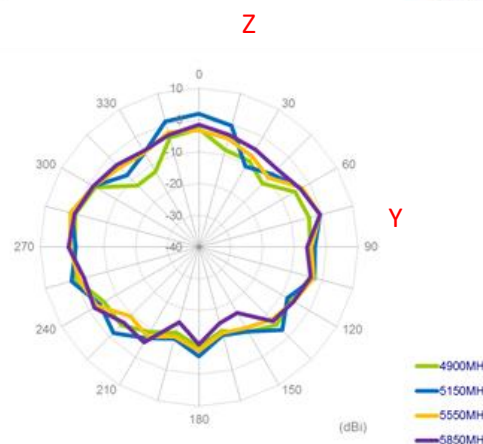
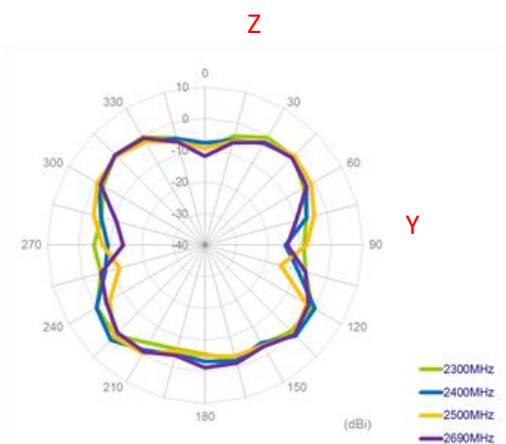
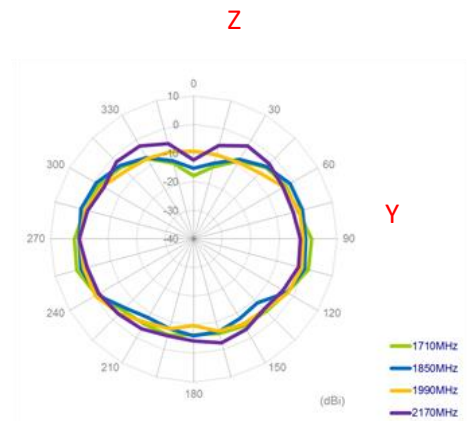
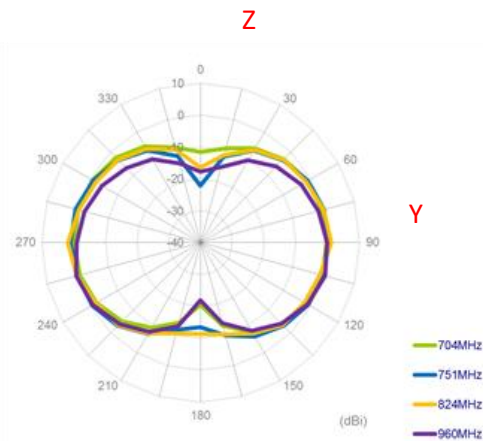
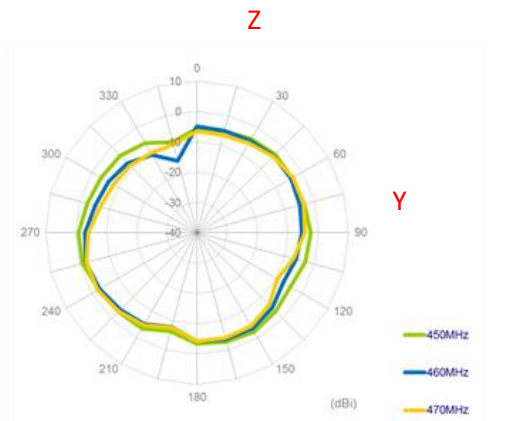

## 4.4 Antenna with 1 meter cable length on Glass Base

### XY Plane

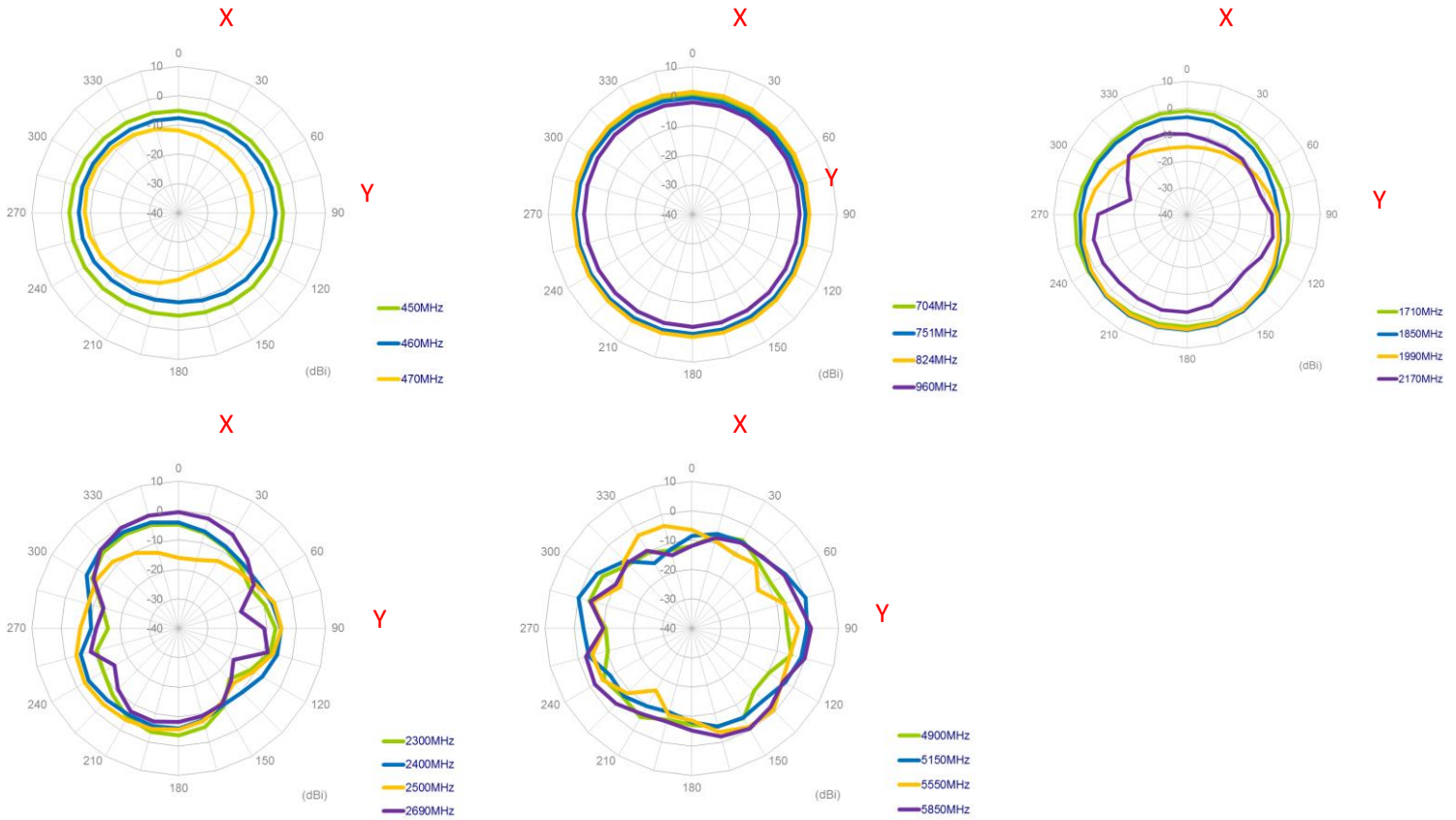

## XZ Plane

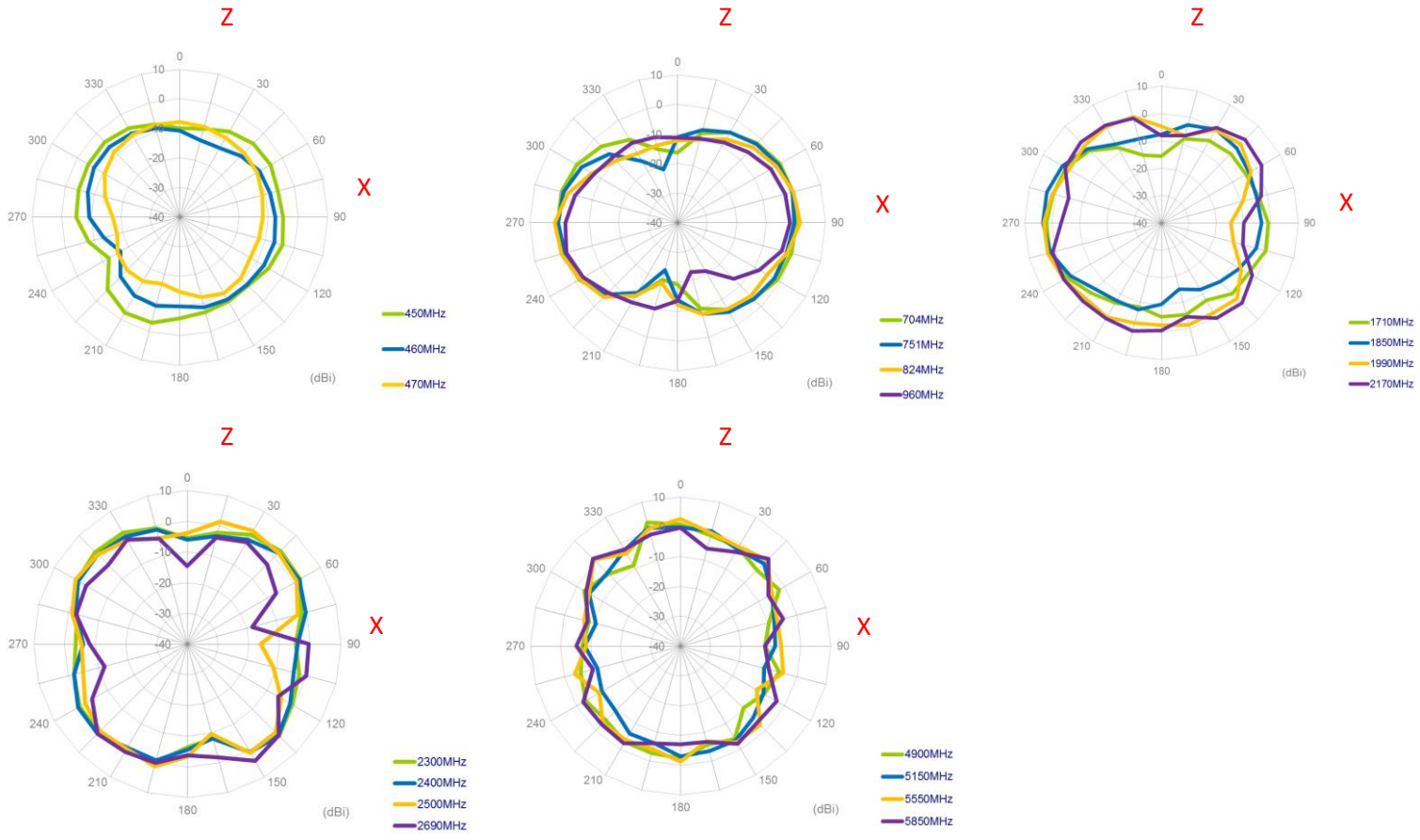

## YZ Plane

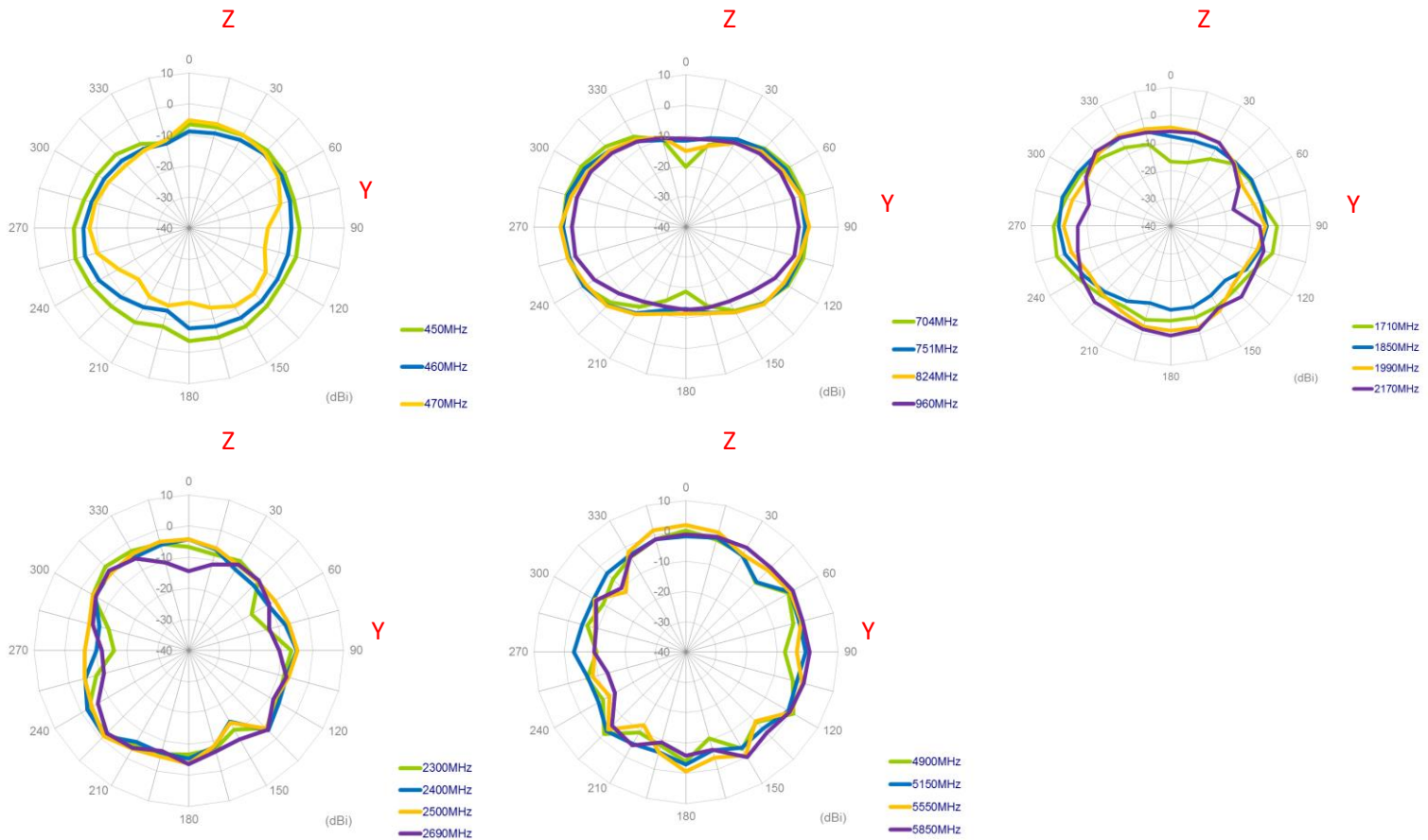



# 5. 3D Radiation Patterns

## 5.1 Free Space

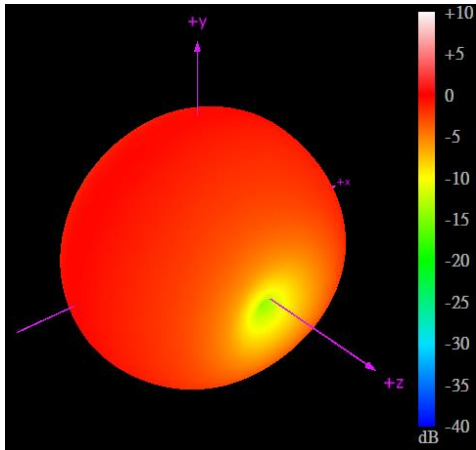

450MHz

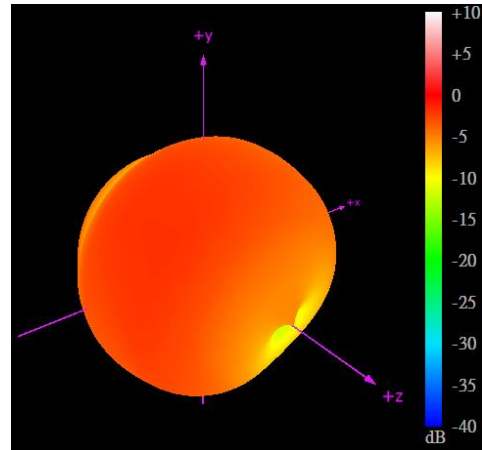

470MHz

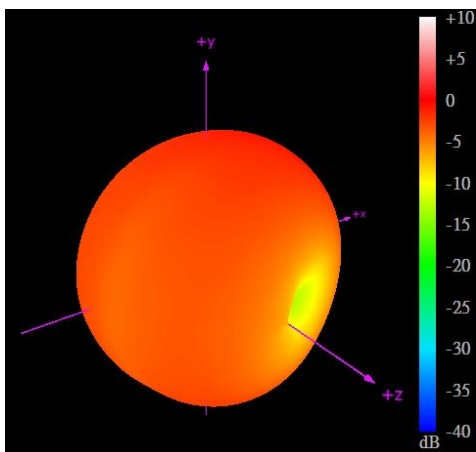

704MHz

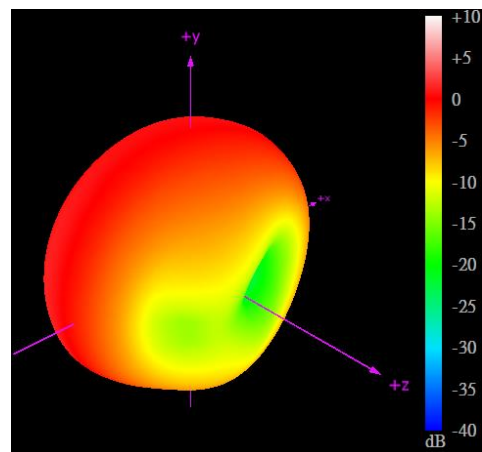

960MHz

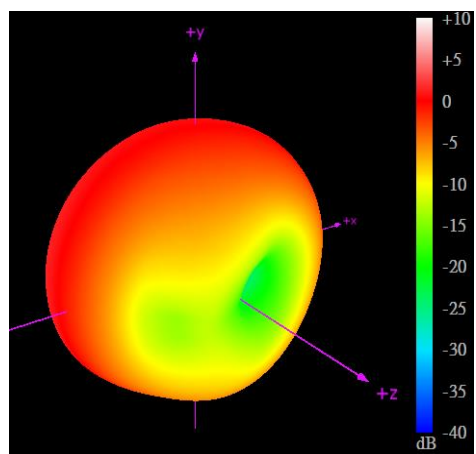

1710MHz

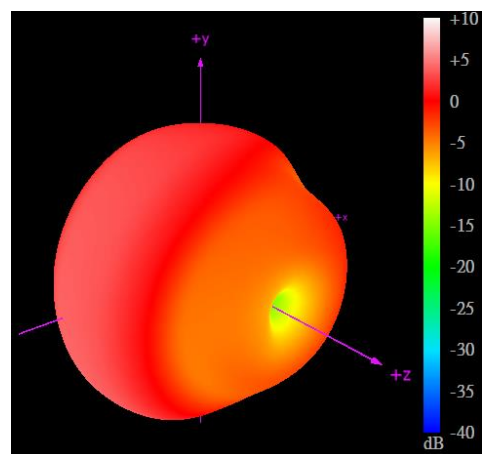

2170MHz

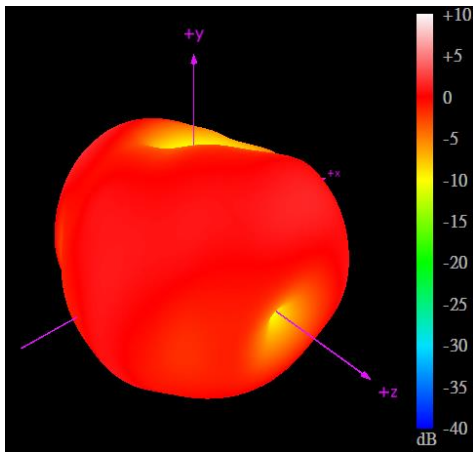

2500MHz

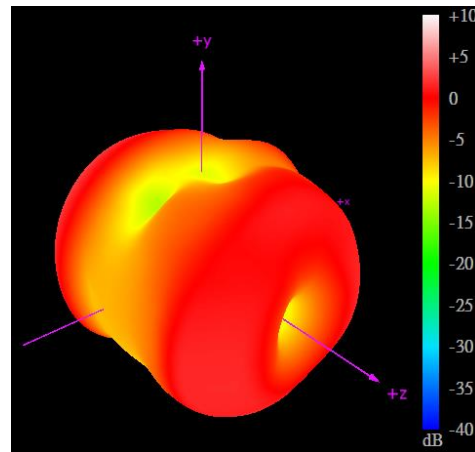

2690MHz

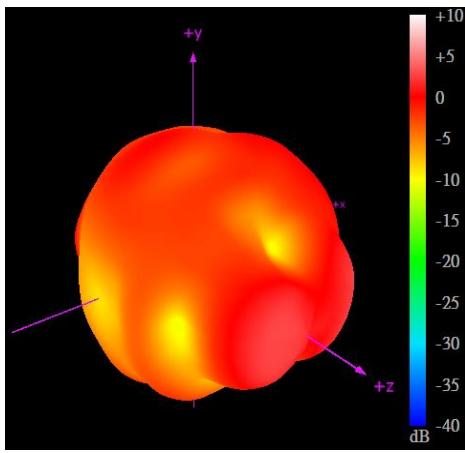

5150MHz

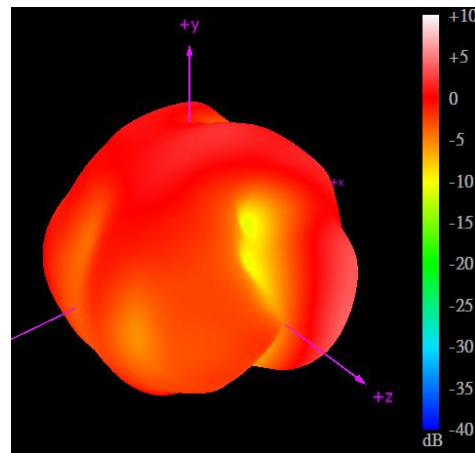

5850MHz

## 5.2 2mm ABS Base

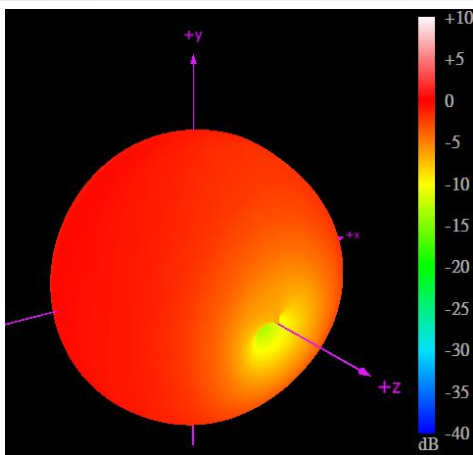

450MHz

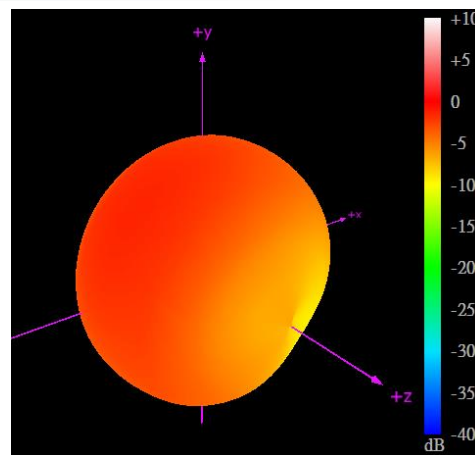

470MHz

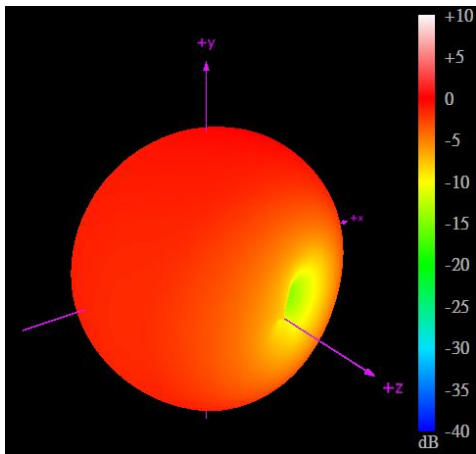

704MHz

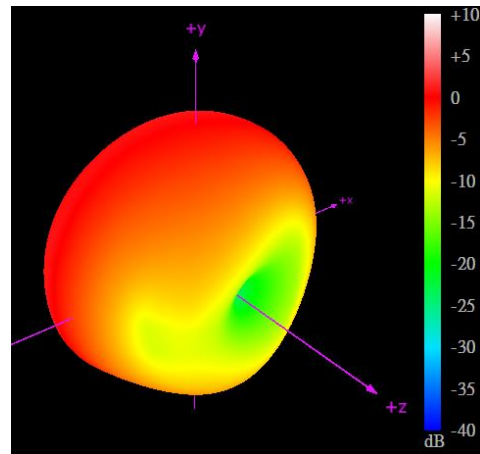

960MHz

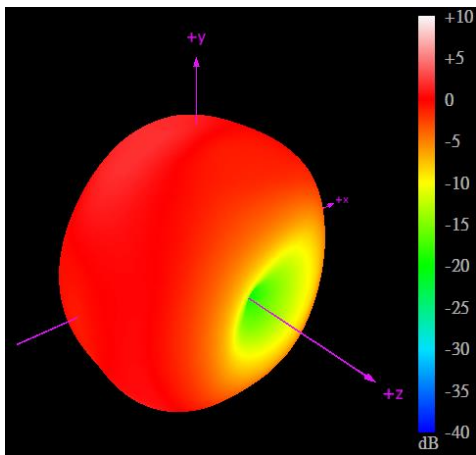

1710MHz

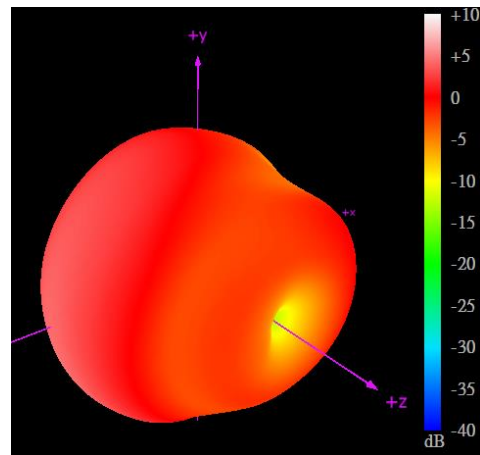

2170MHz

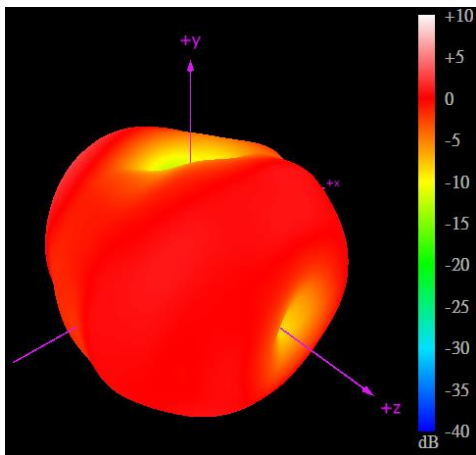

2500MHz

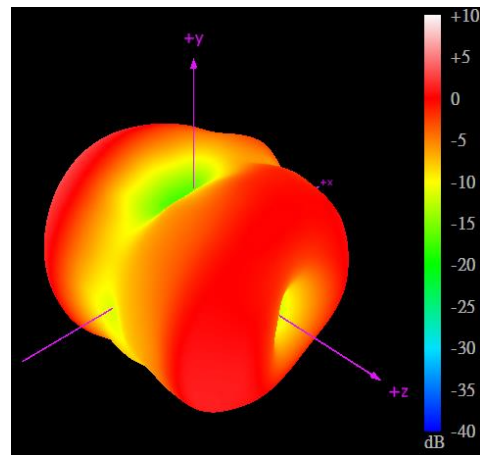

2690MHz

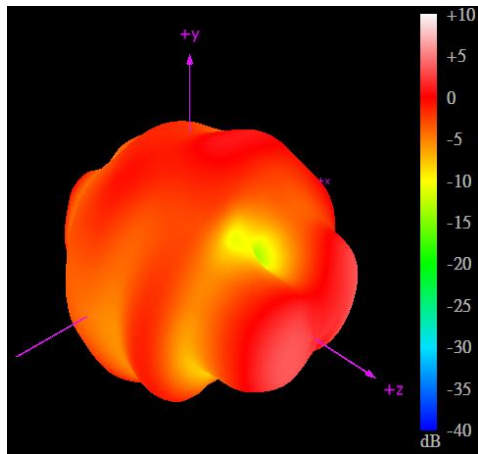

5150MHz

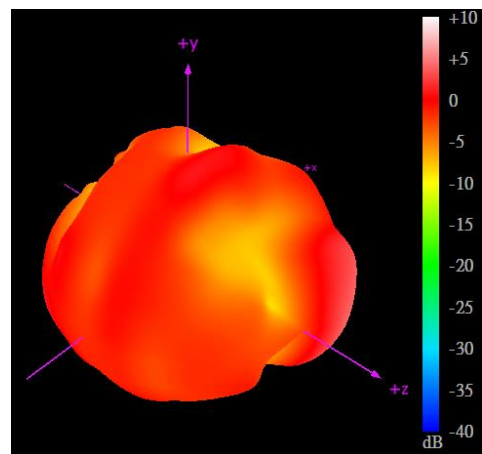

5850MHz

### 5.3 Glass Base

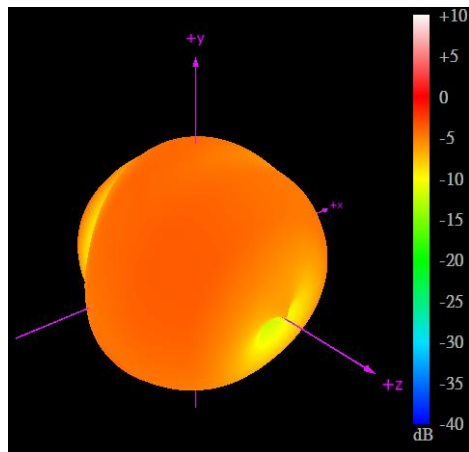

450MHz

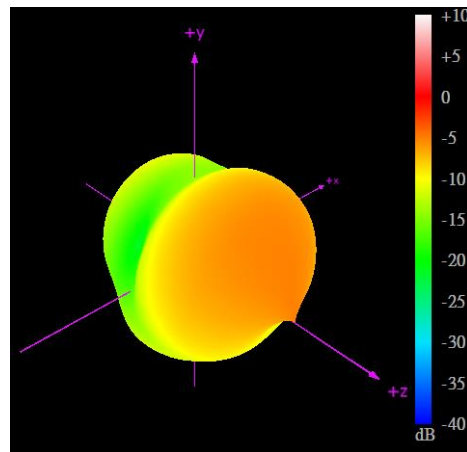

470MHz

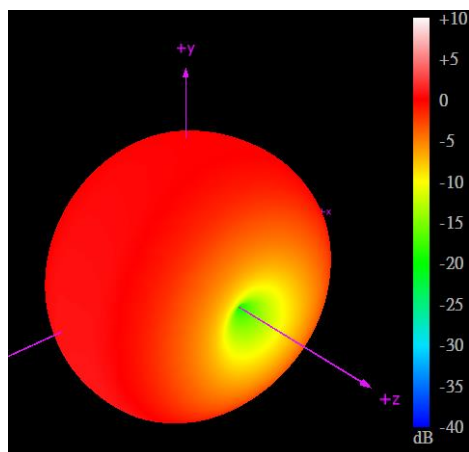

704MHz

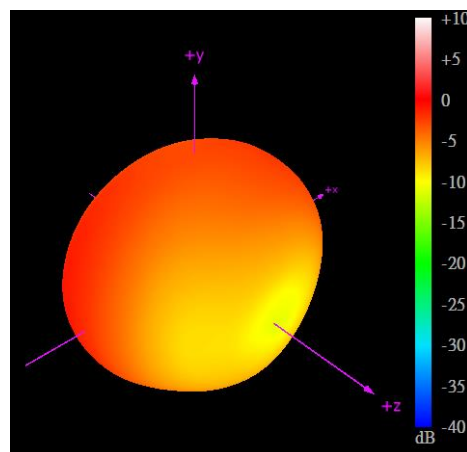

960MHz

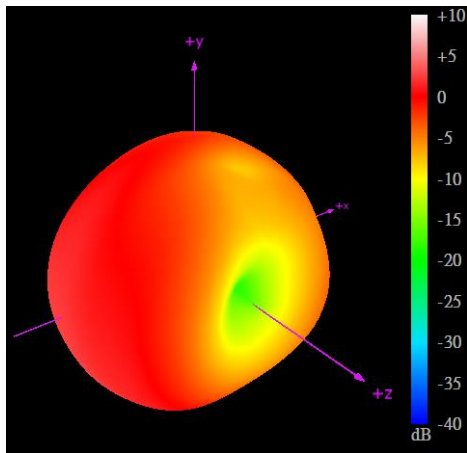

1710MHz

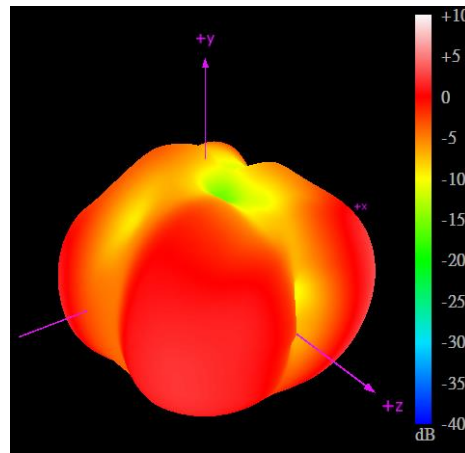

2170MHz

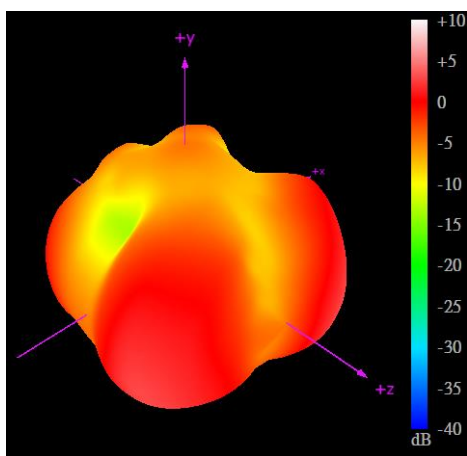

2500MHz

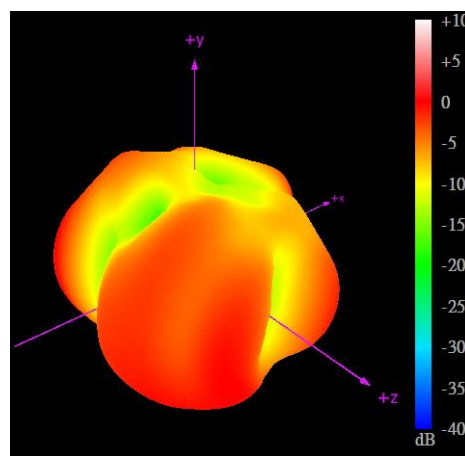

2690MHz

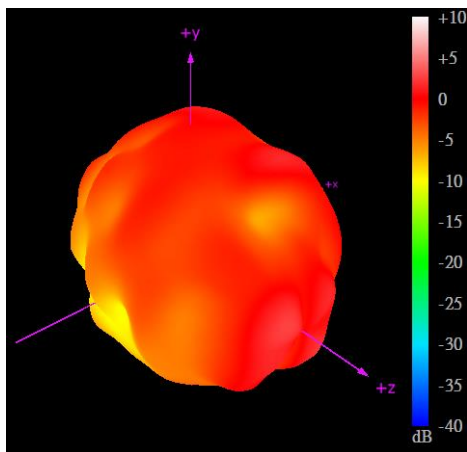

5150MHz

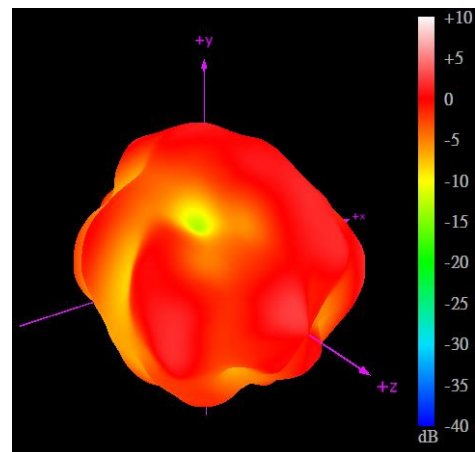

5850MHz

# 6. Mechanical Drawing (Units: mm)

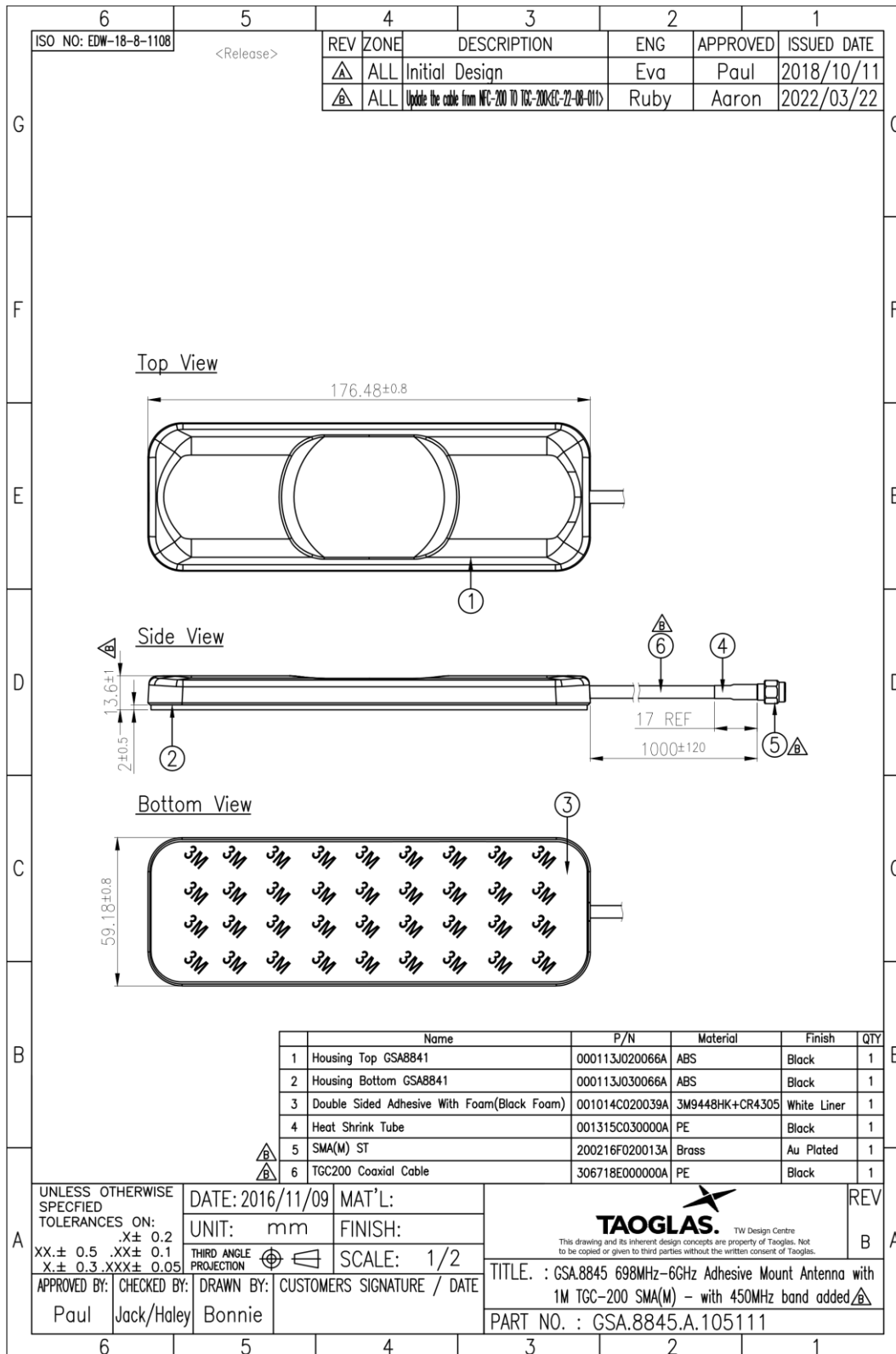

## 7. Packaging

1pc GSA.8845.A.105111 per PE bag  
 Bag Dimensions - 290\*160 mm  
 Weight - 124g

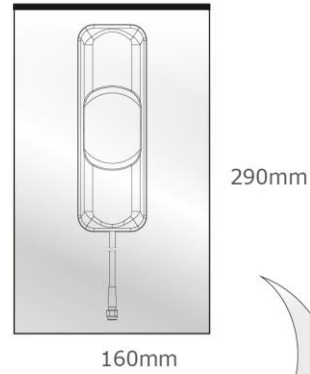

40pcs GSA.8845.A.105111 per carton  
 Carton Dimensions - 370\*370\*300 mm  
 Weight - 6.4Kg

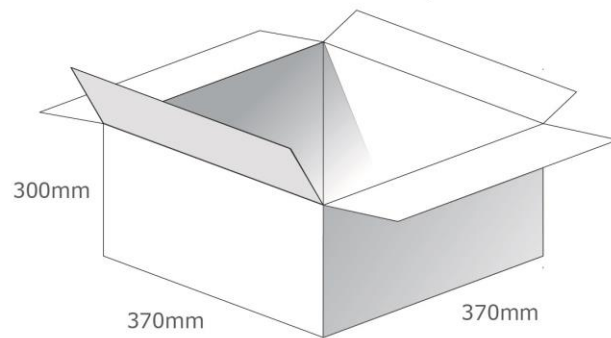

Pallet Dimensions 1200mm\*1000mm\*1400mm  
 24 Cartons per Pallet  
 6 Cartons per layer  
 4 Layers

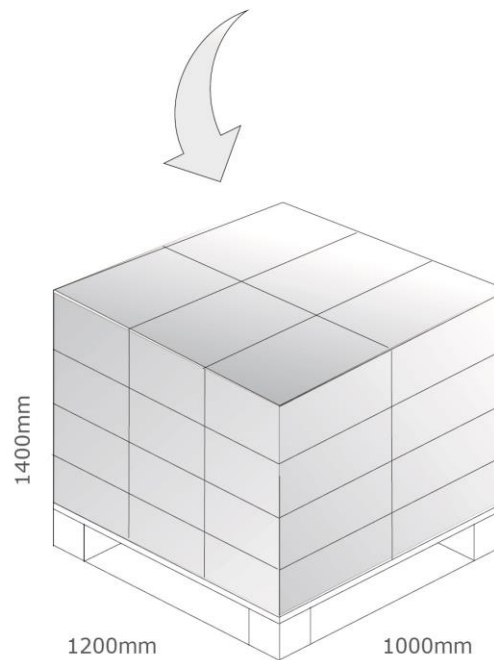

## 8. Application Note

The GSA.8845 antenna performance with different cable lengths and different mounting environments is shown below.

### 8.1 Return Loss – Free Space

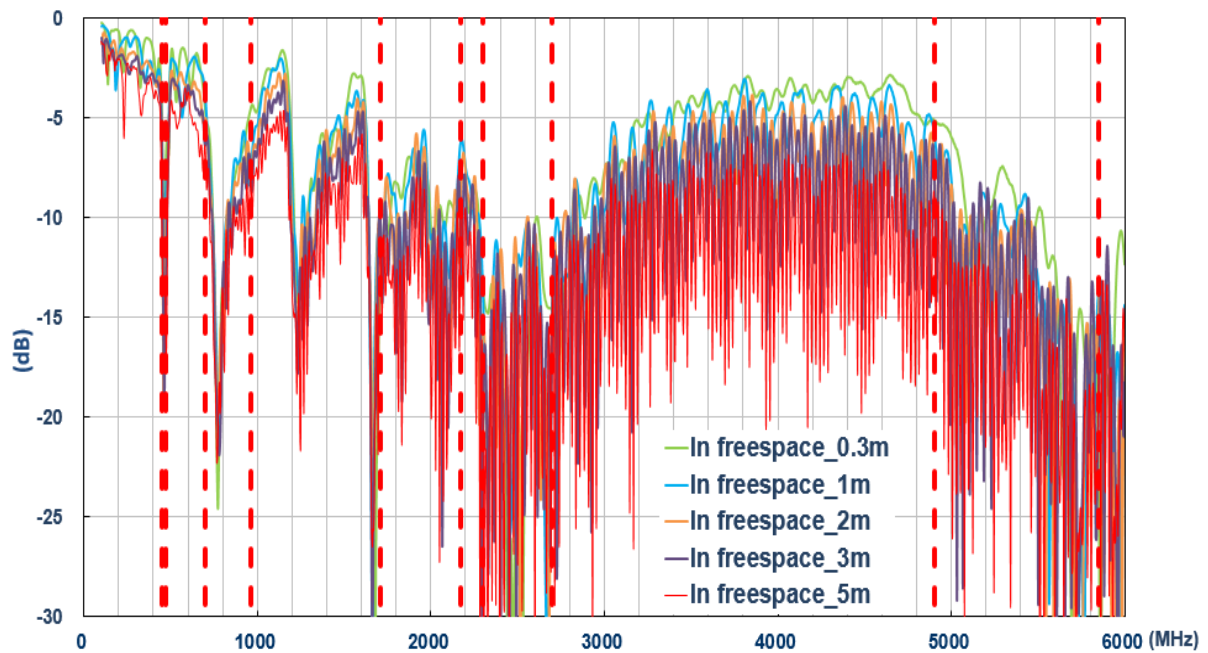

### 8.2 Efficiency – Free Space

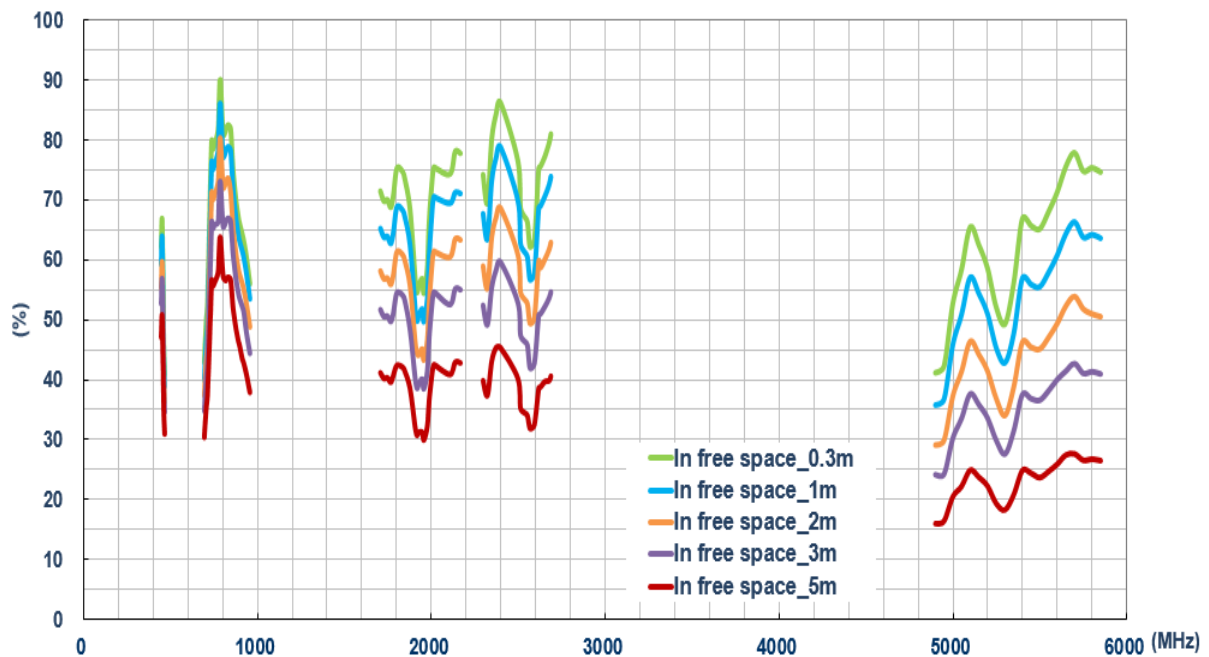



### 8.3 Average Gain – Free Space

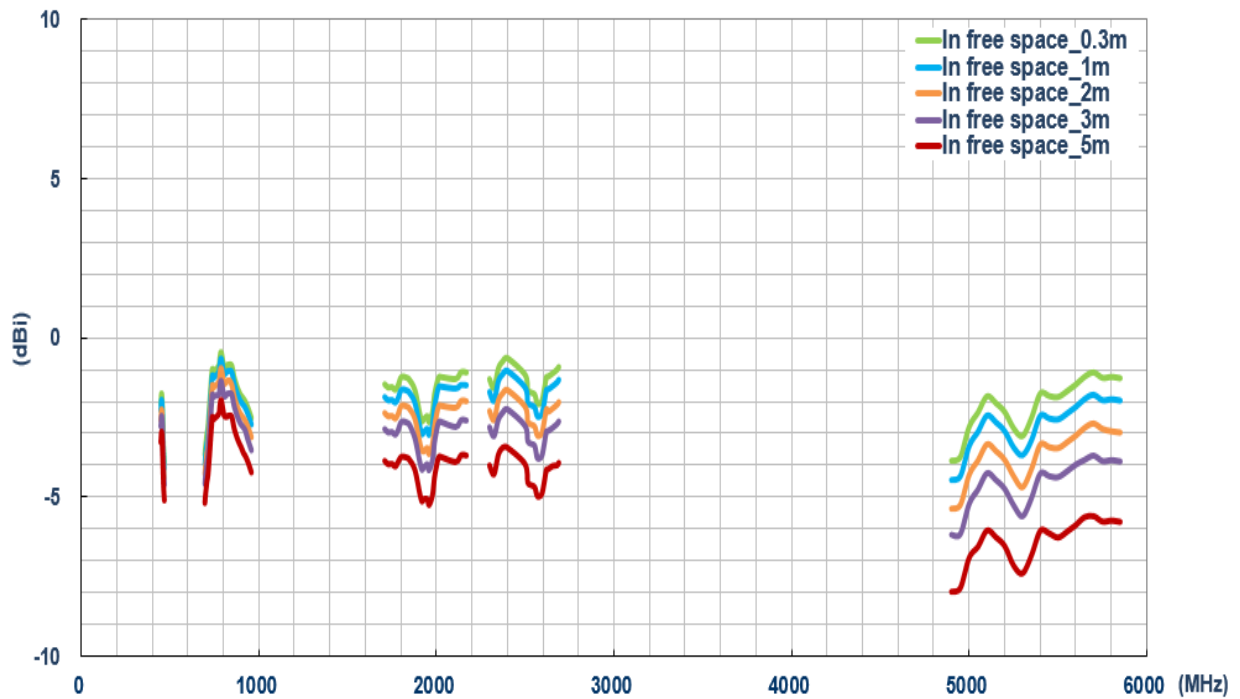

### 8.4 Peak Gain – Free Space



## 8.5 Return Loss – 2mm ABS

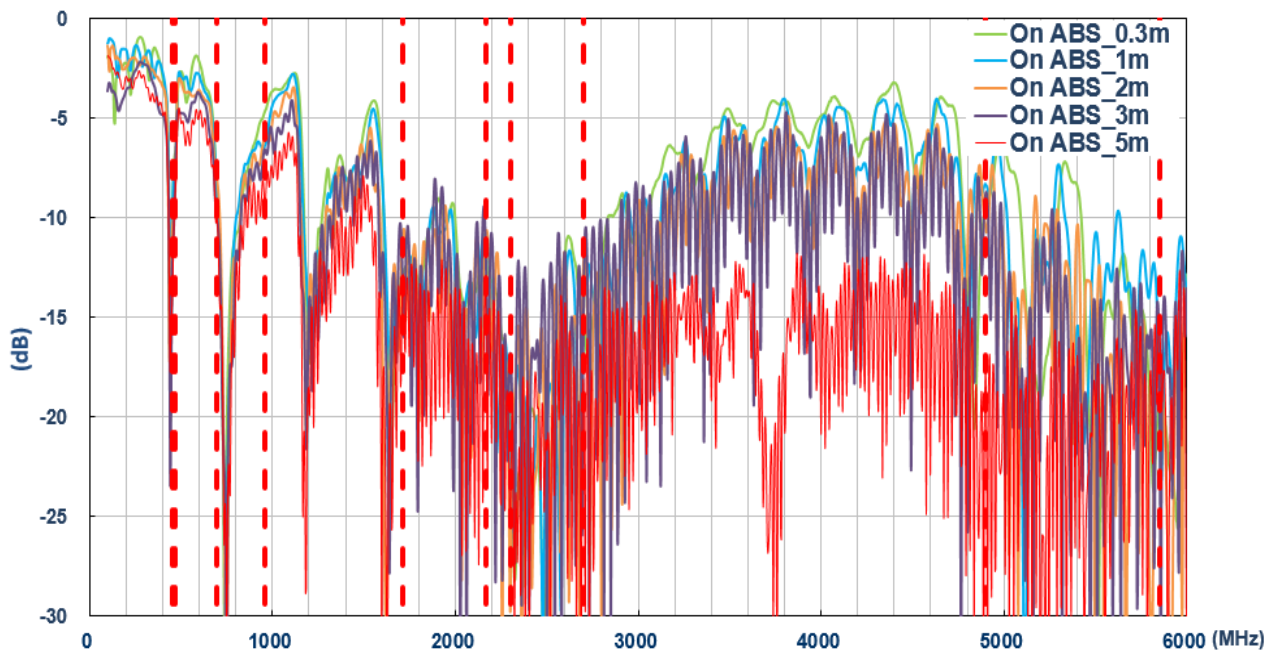

## 8.6 Efficiency – 2mm ABS

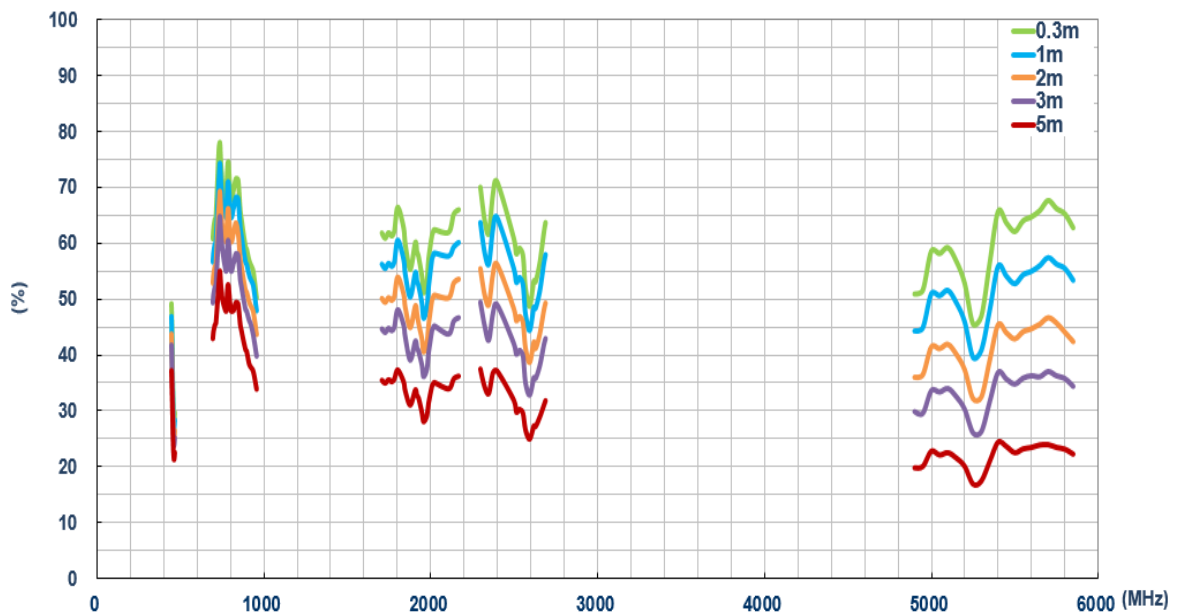

## 8.7 Average Gain – 2mm ABS

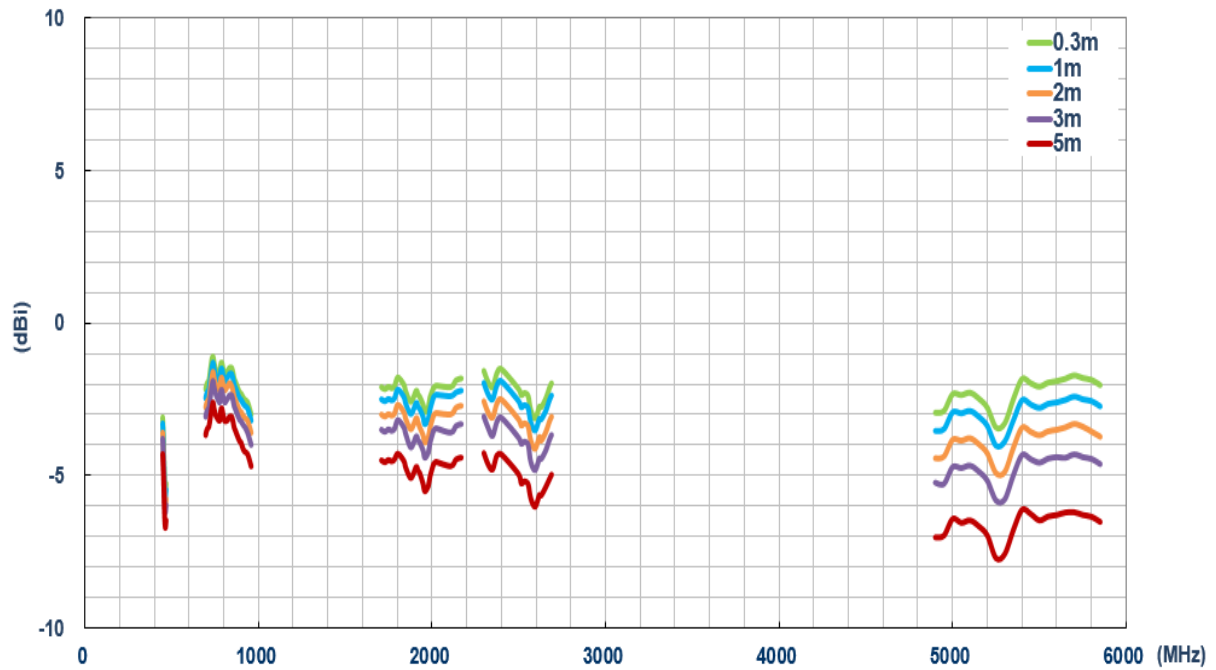

## 8.8 Peak Gain – 2mm ABS

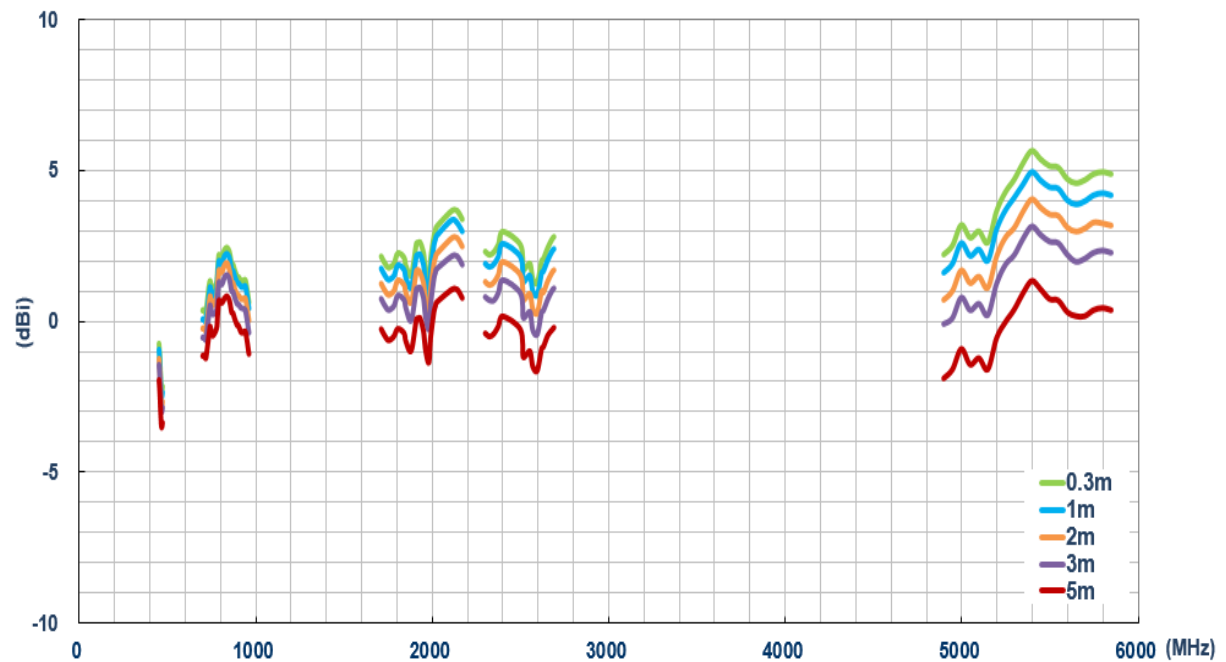

## 8.9 Return Loss – Glass

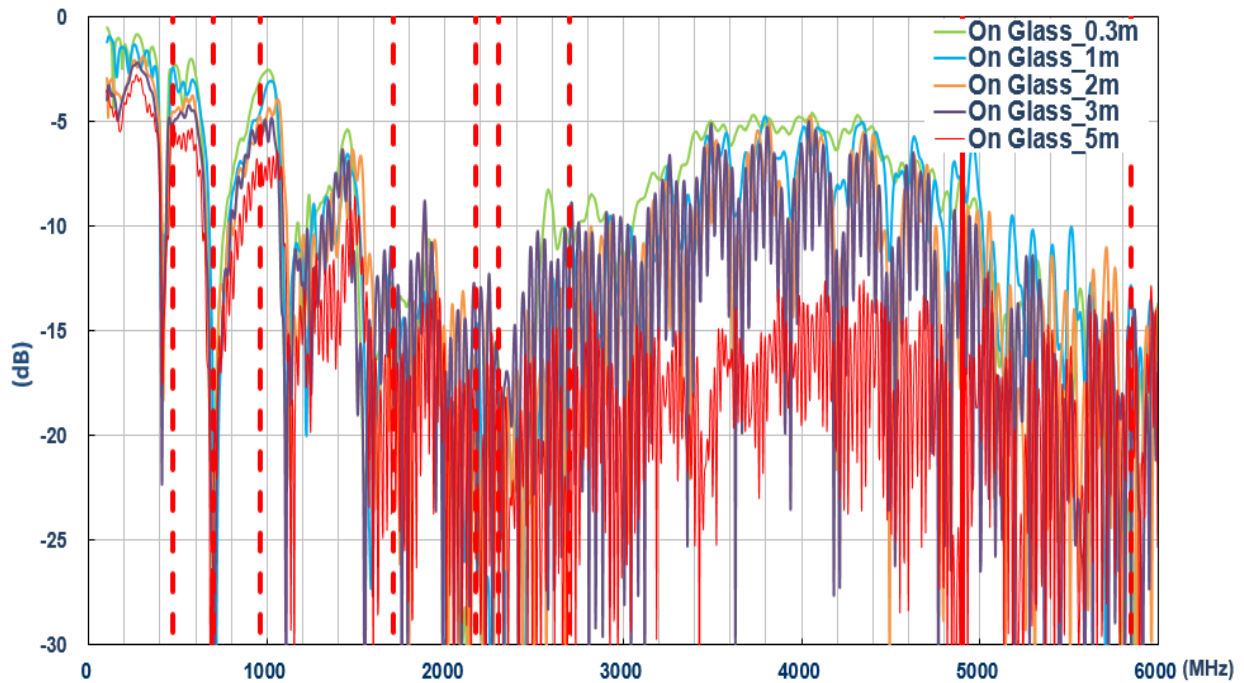

## 8.10 Efficiency – Glass

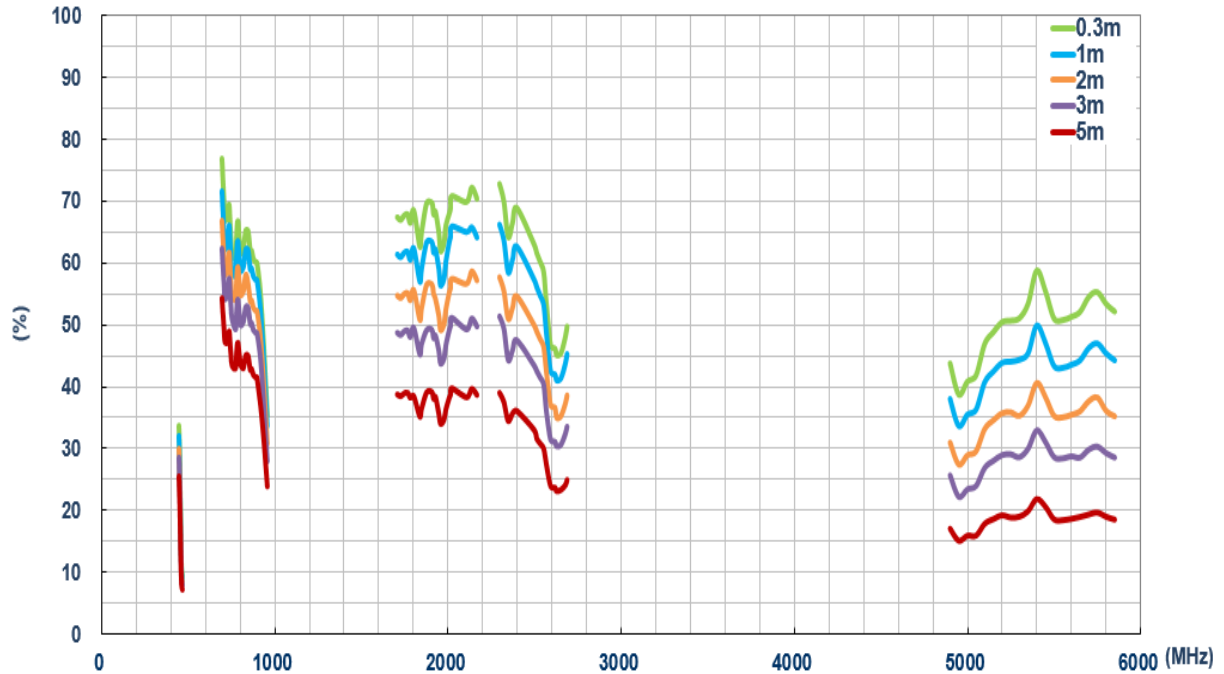

### 8.11 Average Gain – Glass

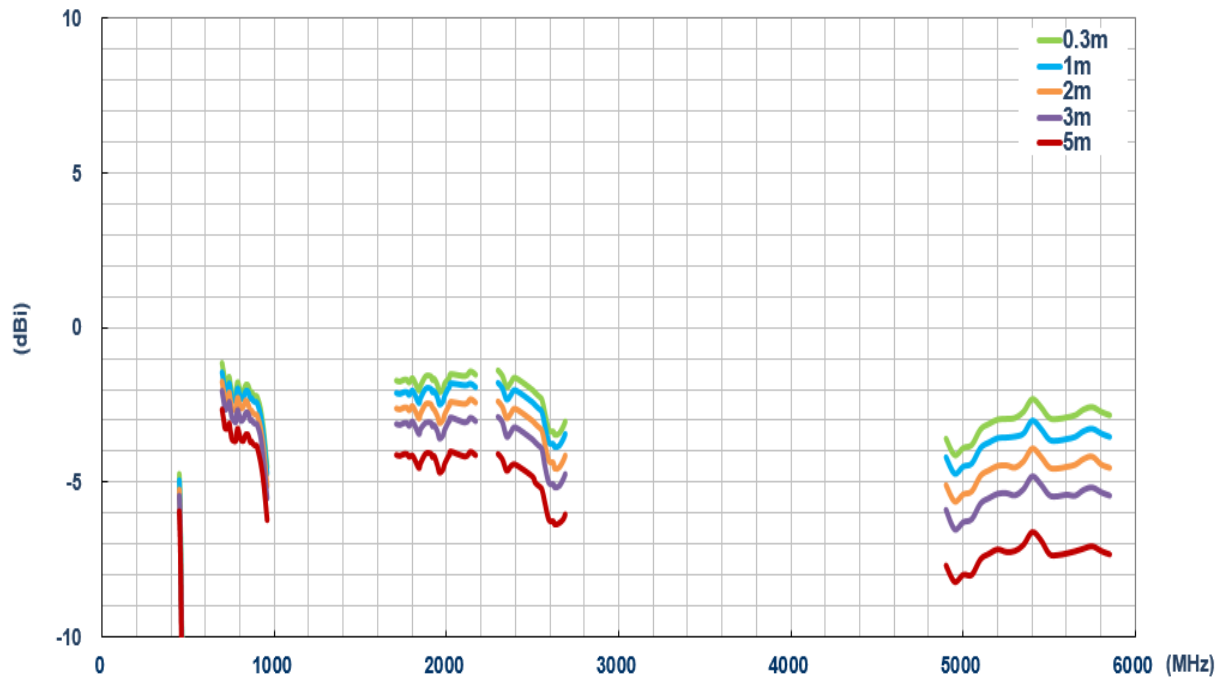

### 8.12 Peak Gain – Glass

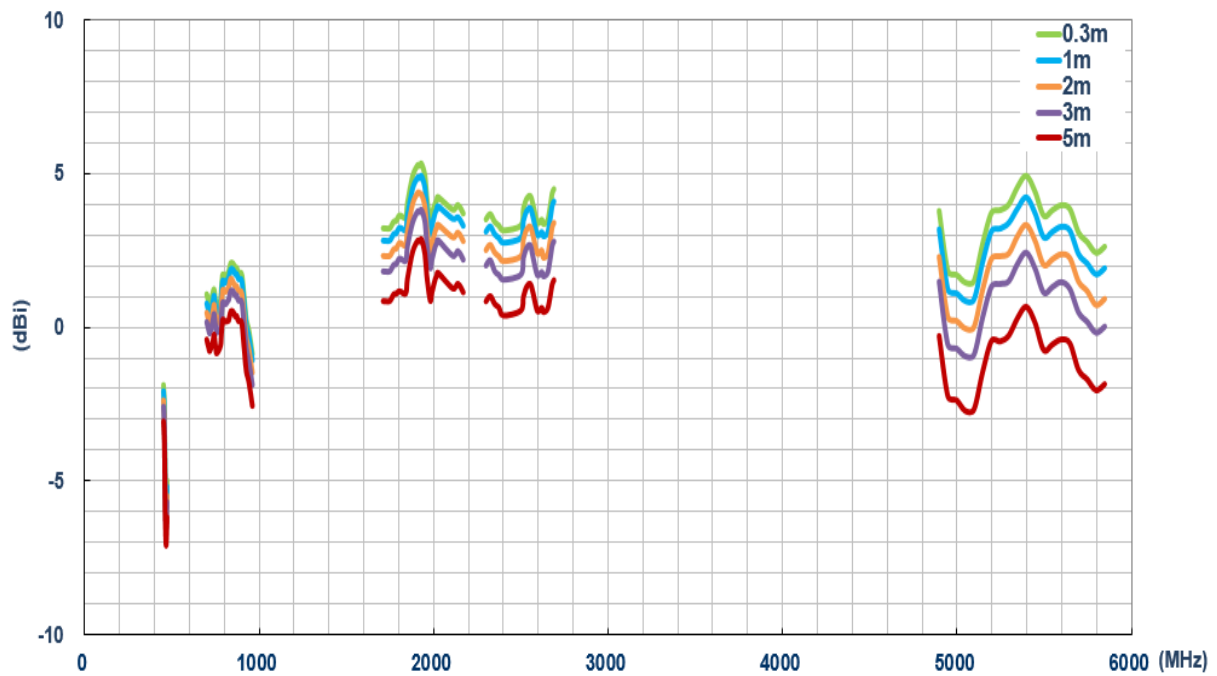

Changelog for the datasheet

**SPE-17-8-040 – GSA.8845.A.105111**

Revision: F (Current Version)	
Date:	2022-06-09
Changes:	Updated cable specification
Changes Made by:	Cesar Sousa

**Previous Revisions**

Revision: E (Current Version)	
Date:	2021-10-26
Changes:	Removed IP Rating
Changes Made by:	Gary West

Revision: D	
Date:	2019-04-23
Changes:	Template amended and graphs for C-Band added
Changes Made by:	Jack Conroy

Revision: C	
Date:	2017-03-08
Changes:	Packaging & Photo Details Updated
Changes Made by:	Carol Faughnan

Revision: B	
Date:	2017-10-23
Changes:	Packaging Details Updated
Changes Made by:	Carol Faughnan

Revision: A (Original First Release)	
Date:	2017-08-09
Notes:	
Author:	David Connolly