

# Overloads Relays

## General Descriptions

Type GT, bimetal-style, overload relays are designed to protect AC circuits and motors against overloads, phase failure, long starting times and prolonged stalling of the motor.

Two versions are available according to the protection function and trip class as below.

1. Differential: 3pole-3bimetal(heater) and trip class 10
2. Differential: 3pole-3bimetal(heater) and trip class 20

## Configuration of the Front

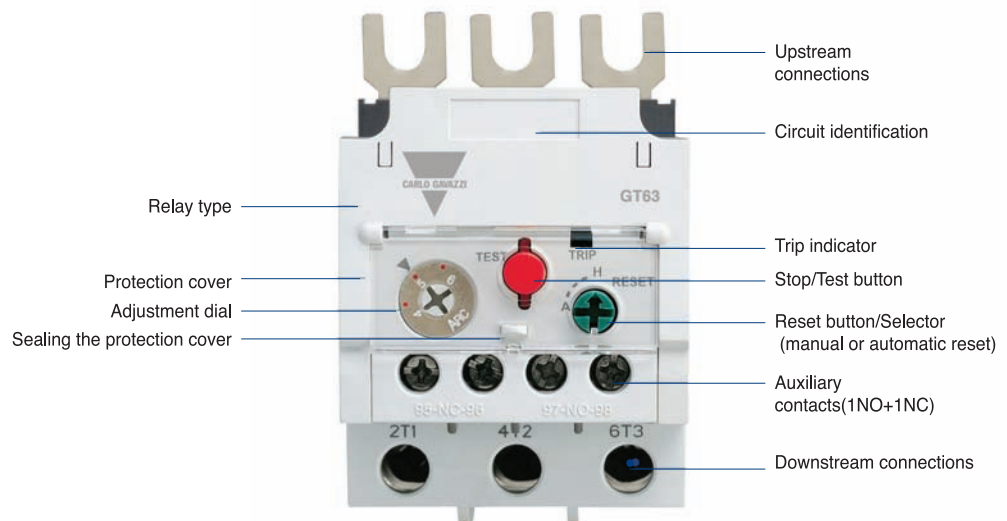

GT32	GT63	GT95
------	------	------



# Overloads Relays

## Environment and Auxiliary Circuit

Environment				
Standards		IEC/EN 60947-1, IEC/EN 60947-4-1	IEC/EN 60947-1, IEC/EN 60947-4-1	
Certifications		CE, CSA, UL	CE, CSA, UL	
Rated operation voltage		Max. 690V	Max. 690V	
Rated insulation voltage		690V	690V	
Rated frequency		50/60Hz	50/60Hz	
Degree of protection (Conforming to IEC 60 529)		IP 20	IP 20	
Ambient air temperature	Storage	-55 ~ +80° C	-55 ~ +80° C	
	Operation	-5 ~ +60° C	-5 ~ +60° C	
Mounting position		Vertical plane	Vertical plane	
Shock resistance (Conforming to IEC 68-2-7)		15gn - 11ms	15gn - 11ms	
Vibration resistance (Conforming to IEC68-2-6)		6G	6G	
Insulation strength (Conforming to IEC 255-5)		6kV	6kV	
Rated impulse withstand voltage (Conforming to IEC 801-5)		6kV	6kV	
Auxiliary contacts characteristics				
Composition		1a1b (1NO +1NC)	1NO+1NC	
Rated thermal current		5A	5A	
Rated operation current	AC15 duty (C600)	120V	1.5A	2.5A
		240V	0.75A	2A
		380V	0.47A	0.47A
		480V	0.375A	0.375A
		500V	0.35A	0.35A
		600V	0.3A	1A
	DC13 duty (R300)	120V	0.22A	0.28A
		240V	0.1A	0.14A
	Connecting conductor	Size	18AWG /1 mm <sup>2</sup>	18AWG /1 mm <sup>2</sup>
	Connection to screw clamp terminals	Type	65/75°C Cu-wire	65/75°C Cu-wire

GT150



GT225



GT400

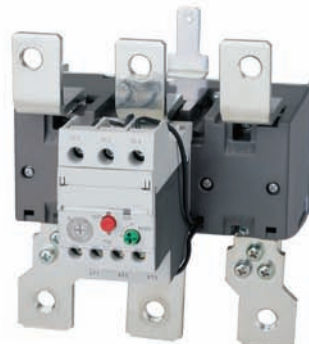

GT800



Specifications are subject to change without notice.

# Overloads Relay Specifications

## GT Type Thermal Overload Relays



**GT32**

Frame size		
Trip class		
Type	Differential type	
Terminal type		
Number of poles		
Rated operational voltage (Ue)		
Rated insulation voltage (Ui)		
Rated impulse voltage (Uimp)		
Degree of protection (IEC 60 529)		
Temperature compensation (° C)		
Functions	Trip indicating	
	Stop	
	Test	
	Manual/Automatic Reset	
Setting range(A)		
Nominal current rating	Wire size	
	mm <sup>2</sup>	AWG
0.14	1	18
0.21		
0.33		
0.52		
0.82		
1.3		
2.1		
3.3		
5		
6.5		
7.5	1~1.5	18~16
8.5		
11	1.5~2.5	16~14
15	2.5	14~12
19	2.5~4	12~10
21.5		
27	4~6	10
30	4~10	10~8
34	6~10	10~8
42	10	8
54		
65	16~25	6~4
74		
83	25~35	4~3
90		
Applied contactors		
Separate mounting unit		

40AF	
10	20
GT32	GT32L
Screw Clamp or Lug	
3	
690V	
Up to 690V	
6kV	
IP 20	
-5~+40°C	
■	
■	
■	
■	
0.1~40A	1~40A
0.1~0.16	
0.16~0.25	
0.25~0.4	
0.4~0.63	
0.63~1	
1~1.6	1~1.6
1.6~2.5	1.6~2.5
2.5~4	2.5~4
4~6	4~6
5~8	5~8
6~9	6~9
7~10	7~10
9~13	9~13
12~18	12~18
16~22	16~22
18~25	18~25
22~32	22~32
-	-
28~40	28~40
CC9, CC12, CC18, CC32, CC40	
GUZ32	



# Overloads Relay Specifications

## GT Type Thermal Overload Relays



Frame size		
Trip class		
Type	Differential type	
Terminal type		
Number of poles		
Rated operational voltage (Ue)		
Rated insulation voltage (Ui)		
Rated impulse voltage (Uimp)		
Degree of protection (IEC 60 529)		
Temperature compensation (° C)		
Functions	Trip indicating	
	Stop	
	Test	
	Manual/Automatic Reset	
Setting range(A)		
Nominal current rating	Wire size	
	mm <sup>2</sup>	AWG
42	10	8
55	16	6
65	25	4
74	25	4
80	35	3
93	35	2
107	50	1
113	50	1
130	50	0
130	70	00
153	95	000
200	120	250
265	185	350
350	240	500
515	185 × 2n	350 × 2n
660	240 × 2n	300 × 3n
Applied contactors		
Separate mounting unit		

150AF	
10	20
GT150	GT150L
Screw Clamp or Lug	
3	
690V	
690V	
6kV	
IP 20	
-5~+40°C	
■	
■	
■	
■	
34~150A	34~150A
34~50	
45~65	
54~75	
63~85	
-	
80~105	
-	
95~130	
110~150	
CC130, CC150	
GUZ150	



# Overloads Relay Operation

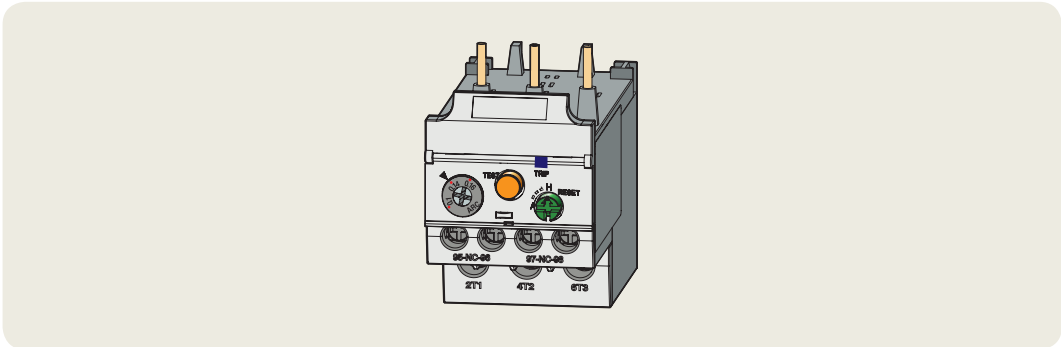
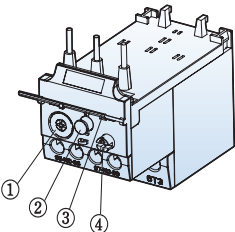

### 1. Adjustment dial



Before adjusting the dial open the protection cover.  
Current setting can be done easily by using (+) or (-) driver.  
Do not rotate the dial out of the setting range.

### 2. Stop/Test button

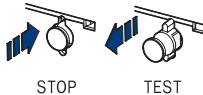

STOP function is executed by pushing the button, which causes the next sequence.  
In case of operation test pull this button.

### 3. Trip indicator



If relay is tripped it comes out.

### 4. Reset button/Selector

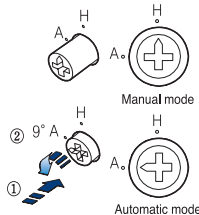

Using a driver the reset mode can be set.  
In case of Manual mode(H) push the button to reset the relay.  
To change to Automatic mode(A) from Manual mode push the button and rotate as shown in the fig.

### 5. Auxiliary contact operation

Terminal no.	Normal	STOP	TEST/TRIP	RESET
NC 95-96				
NO 97-98				

# Overloads Relay Operation

## Separate Mounting Units

These accessories are used to mount the relays separately from contactors. If a relay is combined with a unit, it can be mounted on DIN rail or panel by fixing screws.



Relay	Unit	
	Type	Weight
GT32S	GUZ32S	38g
GT63S, GT63L	GUZ63S, GUZ63L	134g
GT95S, GT95L	GUZ95S, GUZ95L	230g
GT150S, GT150L	GUZ150S, GUZ150L	284g

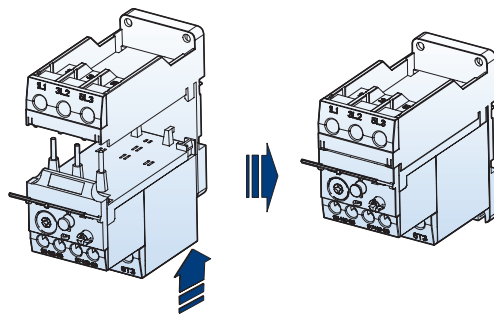

## Terminal Cover Units for Overload Relays



Relay	Unit type	Remarks
GT225	APT-225	2 pcs included
GT400	APT-400	
GT800	APT-600	



# Accessories for Overload Relay

## Remote Reset Units

These accessories are used to reset the relays on the panel door.



Type	Cable length (L)
GTRR-16	400mm /16 in
GTRR-20	500mm /20 in
GTRR-24	600mm /24 in

1. Make the reset bar straight at least 55mm from the panel door and 35mm from the bracket.
2. The bending radius of the flexible reset bar should not be less than 15mm.

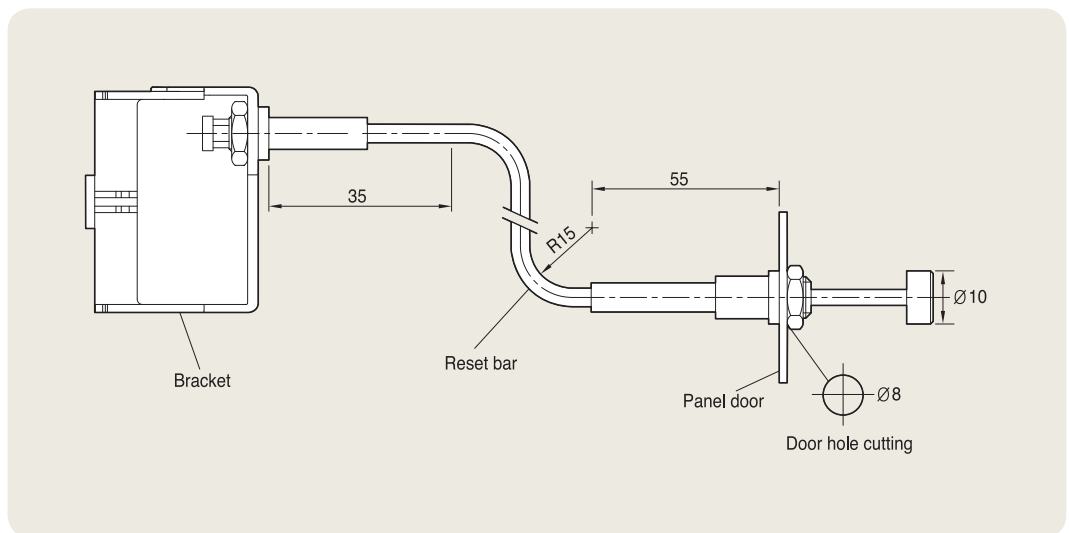

# Accessories for Overload Relay

## Installation

1. Fit the bracket with the relay as indicated(\*1) below.
2. Separate Nut(\*3) and Head cap(\*4) from the reset bar first.  
Insert the reset bar into the panel hole and then fix it with the Nut and Head.
3. To separate the bracket from the relay lift the \*2 part as shown in the fig.

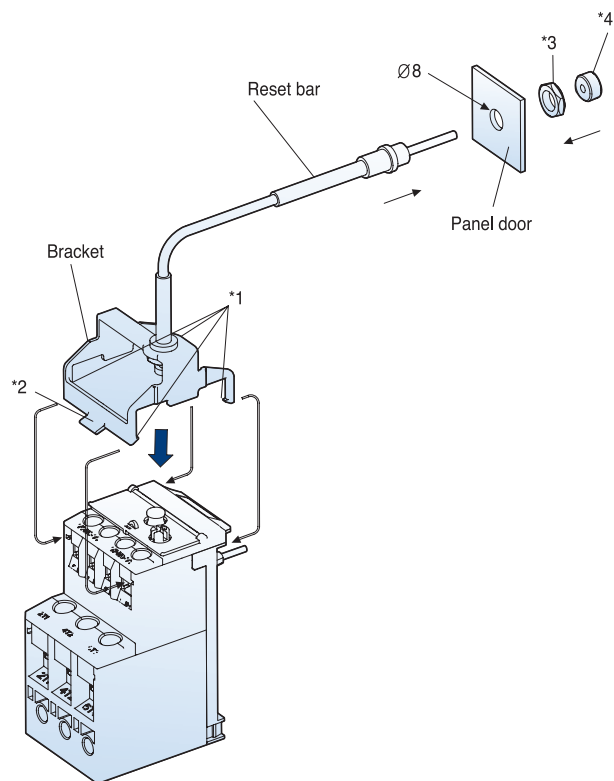
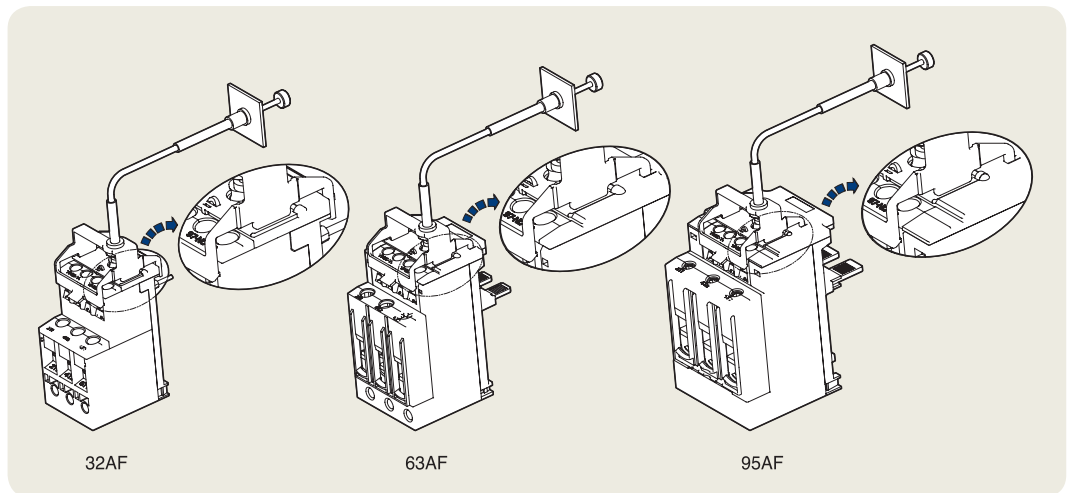

# Overload Relay Ordering Types

## Bimetallic Overload for 32AF Contactors

Direct mounting type



GT32

Setting Range (A)	Ordering Type Differential		Contactor	Separate mounting unit
	Class 10 Screw Terminal	Class 20 Screw Terminal		
0.1~0.16	GT32S0.16A	GT32LS0.16A	CC9 CC12 CC18 CC22 CC32 CC40	GUZ32S
0.16~0.25	GT32S0.25A	GT32LS0.25A		
0.25~0.4	GT32S0.4A	GT32LS0.4A		
0.4~0.63	GT32S0.63A	GT32LS0.63A		
0.63~1	GT32S1A	GT32LS1A		
1~1.6	GT32S1.6A	GT32LS1.6A		
1.6~2.5	GT32S2.5A	GT32LS2.5A		
2.5~4	GT32S4A	GT32LS4A		
4~6	GT32S6A	GT32LS6A		
5~8	GT32S8A	GT32LS8A		
6~9	GT32S9A	GT32LS9A		
7~10	GT32S10A	GT32LS10A		
9~13	GT32S13A	GT32LS13A		
12~18	GT32S18A	GT32LS18A		
16~22	GT32S22A	GT32LS22A		
18~25	GT32S25A	GT32LS25A		
22~32	GT32S36A	GT32LS36A		
28~40	GT32S40A	GT32LS40A		

# Overload Relay Ordering Types

## Bimetallic Overload for 65AF Contactors

Direct mounting type



GT63

Setting Range (A)	Ordering Type Differential Class 10		Ordering Type Differential Class 20		Contactor	Separate mounting unit
	Screw Terminal	Lug Terminal	Screw Terminal	Lug Terminal		
4~6	GT63S6A	GT63L6A	GT63LS6A	GT63LL6A	CC50 CC65	GUZ63S GUZ63L
5~8	GT63S8A	GT63L8A	GT63LS8A	GT63LL8A		
6~9	GT63S9A	GT63L9A	GT63LS9A	GT63LL9A		
7~10	GT63S10A	GT63L10A	GT63LS10A	GT63LL10A		
9~13	GT63S13A	GT63L13A	GT63LS13A	GT63LL13A		
12~18	GT63S18A	GT63L18A	GT63LS18A	GT63LL18A		
16~22	GT63S22A	GT63L22A	GT63LS22A	GT63LL22A		
18~25	GT63S25A	GT63L25A	GT63LS25A	GT63LL25A		
24~36	GT63S36A	GT63L36A	GT63LS36A	GT63LL36A		
28~40	GT63S40A	GT63L40A	GT63LS40A	GT63LL40A		
34~50	GT63S50A	GT63L50A	GT63LS50A	GT63LL50A		
45~65	GT63S65A	GT63L65A	GT63LS65A	GT63LL65A		

Note: overload terminal type must match contactors terminal type.

## Bimetallic Overload for 100AF Contactors



GT100

Setting Range (A)	Ordering Type Differential Class 10		Ordering Type Differential Class 20		Contactor	Separate mounting unit
	Screw Terminal	Lug Terminal	Screw Terminal	Lug Terminal		
7~10	GT95S10A	GT95L10A	GT95LS10A	GT95LL10A	CC75 CC85 CC100	GUZ95S GUZ95L
9~13	GT95S13A	GT95L13A	GT95LS13A	GT95LL13A		
12~18	GT95S18A	GT95L18A	GT95LS18A	GT95LL18A		
16~22	GT95S22A	GT95L22A	GT95LS22A	GT95LL22A		
18~25	GT95S25A	GT95L25A	GT95LS25A	GT95LL25A		
24~36	GT95S36A	GT95L36A	GT95LS36A	GT95LL36A		
28~40	GT95S40A	GT95L40A	GT95LS40A	GT95LL40A		
34~50	GT95S50A	GT95L50A	GT95LS50A	GT95LL50A		
45~65	GT95S65A	GT95L65A	GT95LS65A	GT95LL65A		
54~75	GT95S75A	GT95L75A	GT95LS75A	GT95LL75A		
63~85	GT95S85A	GT95L85A	GT95LS85A	GT95LL85A		
70~98	GT95S98A	GT95L98A	GT95LS98A	GT95LL98A		
80~100	GT95S100A	GT95L100A	GT95LS100A	GT95LL100A		

Note: overload terminal type must match contactors terminal type.

# Overload Relay Ordering Types

## Bimetallic Overload for 150AF Contactors



GT150

Setting Range (A)	Ordering Type Differential Class 10		Ordering Type Differential Class 20		Contactor	Separate mounting unit
	Screw Terminal	Lug Terminal	Screw Terminal	Lug Terminal		
34~50	GT150S50A	GT150L50A	GT150LS50A	GT150LL50A	CC130 CC150	GUZ150S
45~65	GT150S65A	GT150L65A	GT150LS65A	GT150LL65A		
54~75	GT150S75A	GT150L75A	GT150LS75A	GT150LL75A		
63~85	GT150S85A	GT150L85A	GT150LS85A	GT150LL85A		
80~105	GT150S105A	GT150L105A	GT150LS105A	GT150LL105A		
95~130	GT150S130A	GT150L130A	GT150LS130A	GT150LL130A		
110~150	GT150S150A	GT150L150A	GT150LS150A	GT150LL150A		

Note: overload terminal type must match contactors terminal type.

## Bimetallic Overload for 225AF Contactors



GT225

Setting Range (A)	Ordering Type Differential		Contactor
	Class 10	Class 20	
	Screw Terminal		
65~100	GT225S100A	GT225LS100A	CC185 CC225
85~125	GT225S125A	GT225LS125A	
100~160	GT225S160A	GT225LS160A	
120~185	GT225S185A	GT225LS185A	
160~240	GT225S240A	GT225LS240A	

## Bimetallic Overload for 400AF Contactors

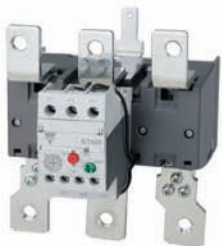

GT400

Setting Range (A)	Ordering Type Differential		Contactor
	Class 10	Class 20	
	Screw Terminal		
85~125	GT400S125A	GT400LS125A	CC265 CC330 CC400
100~160	GT400S160A	GT400LS160A	
120~185	GT400S185A	GT400LS185A	
160~240	GT400S240A	GT400LS240A	
200~330	GT400S330A	GT400LS330A	
260~400	GT400S400A	GT400LS400A	

## Bimetallic Overload for 800AF Contactors



GT800

Setting Range (A)	Ordering Type Differential		Contactor
	Class 10	Class 20	
	Screw Terminal		
200~330	GT800S330A	GT800LS330A	CC500
260~400	GT800S400A	GT800LS400A	CC630
400~630	GT800S630A	GT800LS630A	CC800
520~800	GT800S800A	GT800LS800A	

To instantly view a data sheet and specify products, visit [www.GavazziOnline.com](http://www.GavazziOnline.com)

# Overload Relay Trip Curves

## Class 10A, 40AF

GT32S

Cold starting

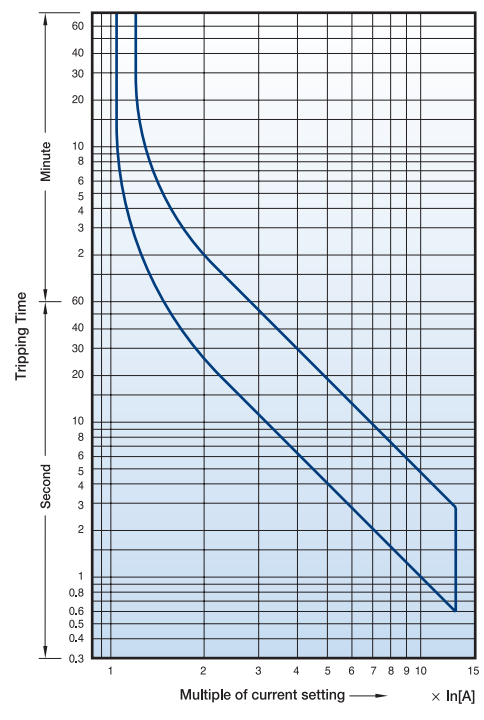

Hot starting

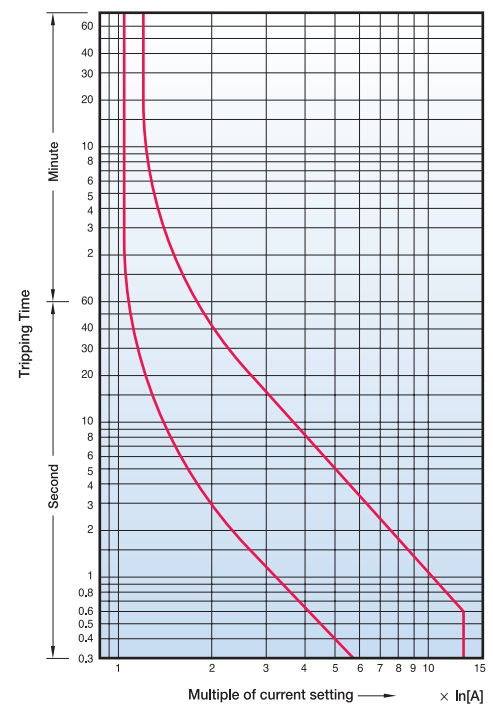

## Class 20, 40AF

GT32LS

Cold starting

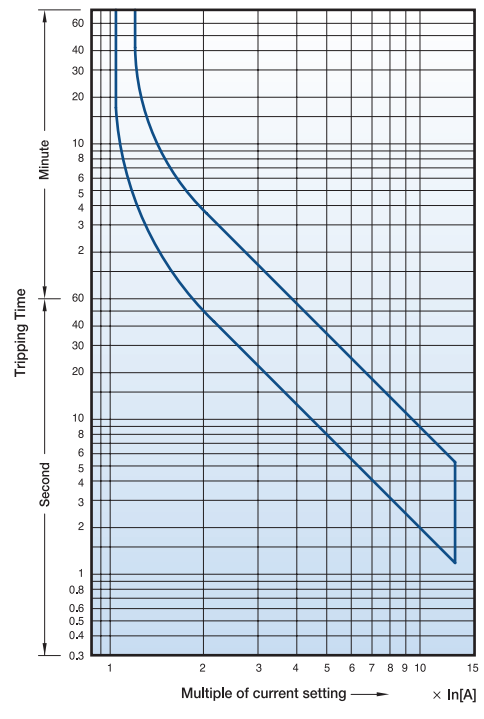

Hot starting

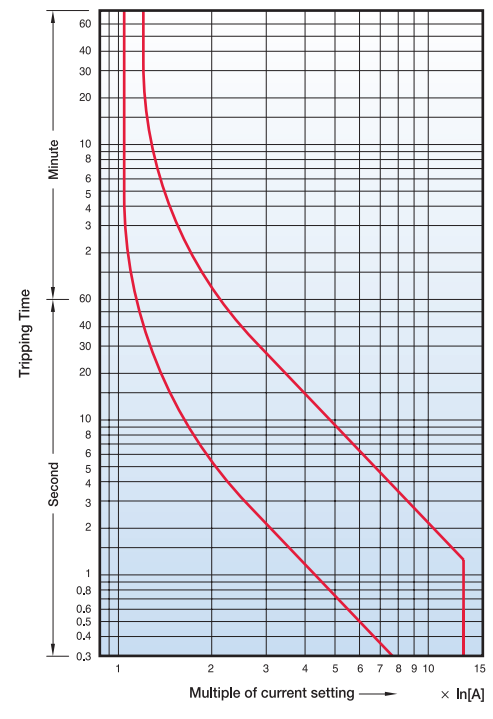

# Overload Relay Trip Curves

## Class 10A, 65AF

- GT63S
- GT63L

Cold starting

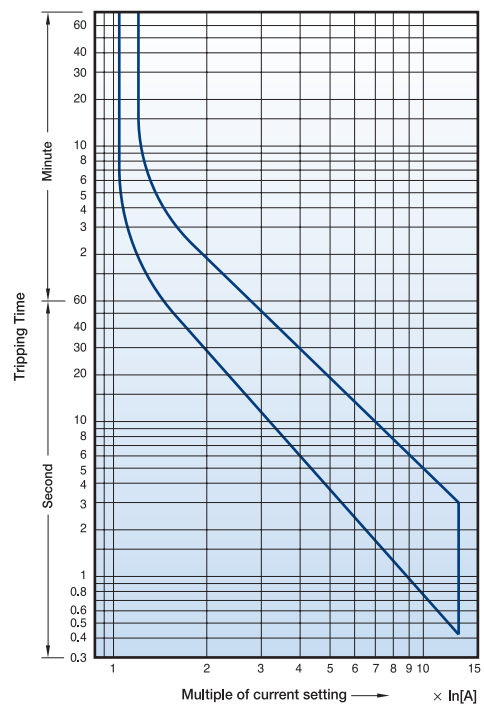

Hot starting

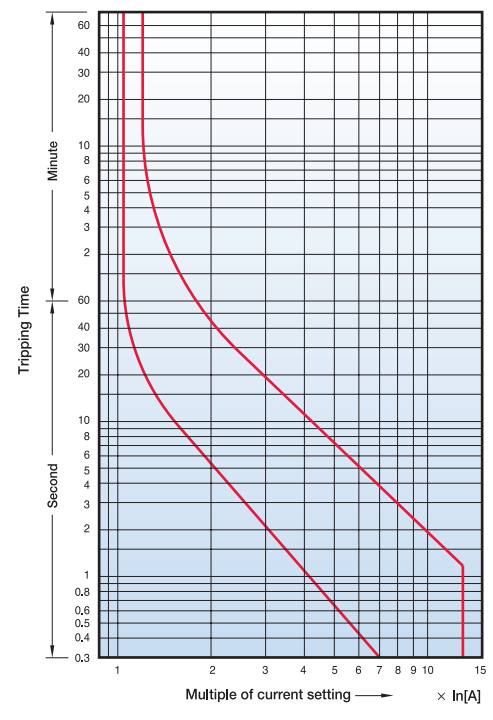

## Class 20, 65AF

- GT63LS
- GT63LL

Cold starting

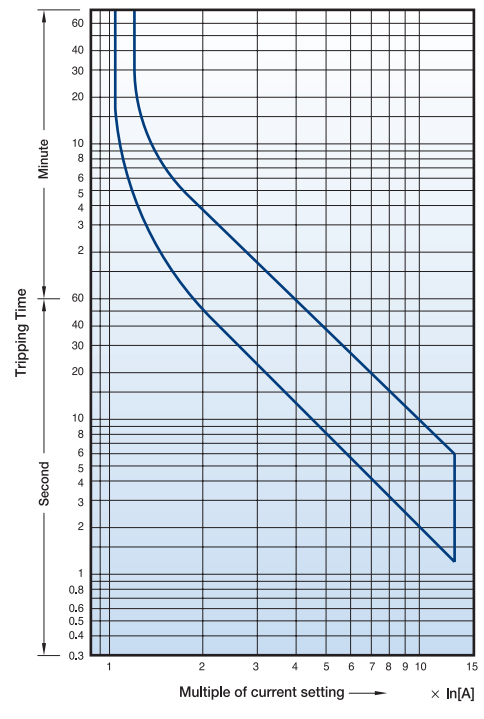

Hot starting

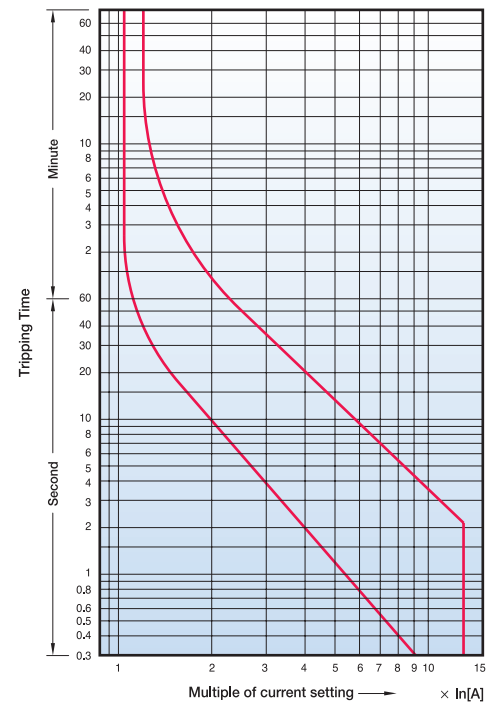

# Overload Relay Trip Curves

## Class 10A, 100AF

- GT95S
- GT95L

Cold starting

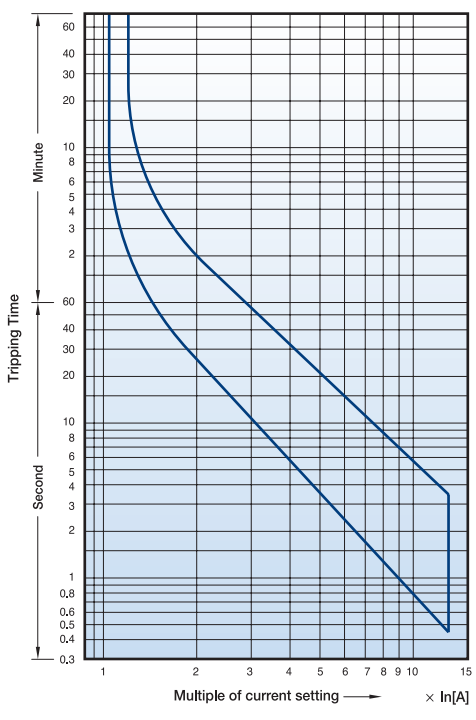

Hot starting

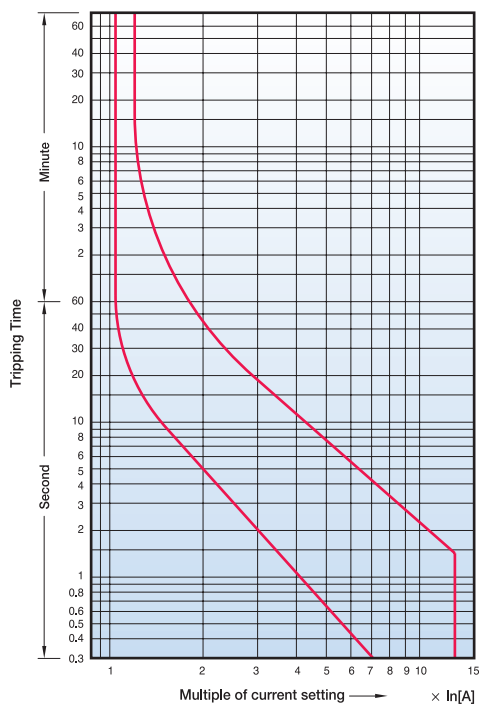

## Class 20, 100AF

- GT95LS
- GT95LL

Cold starting

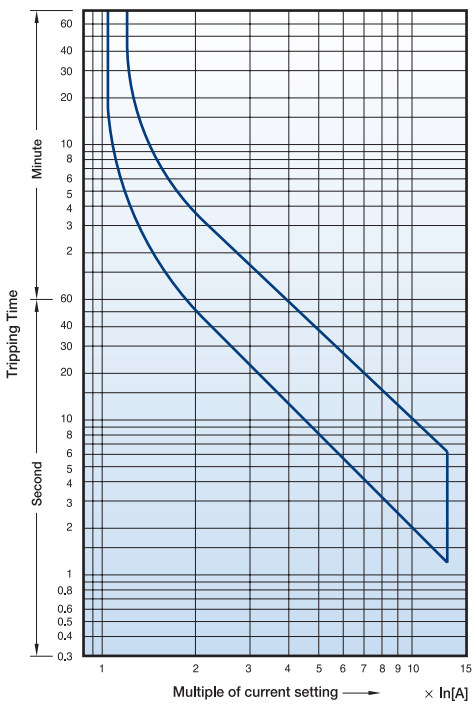

Hot starting

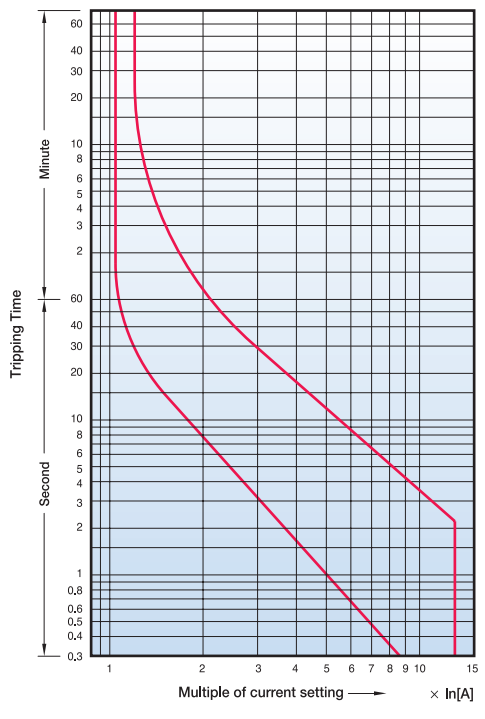



# Overload Relay Trip Curves

## Class 10A, 150AF

- GT150S
- GT150L

Cold starting

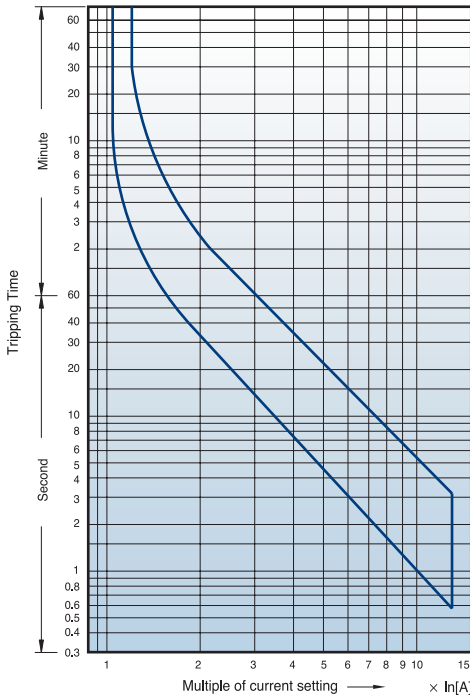

Hot starting

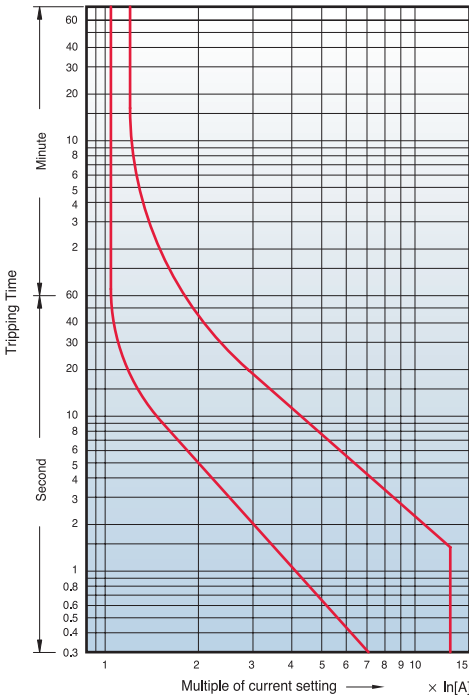

## Class 20, 150AF

- GT150LS
- GT150LL

Cold starting

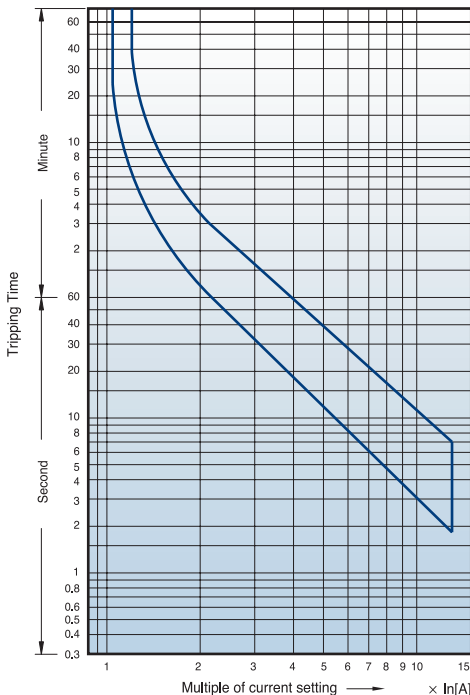

Hot starting

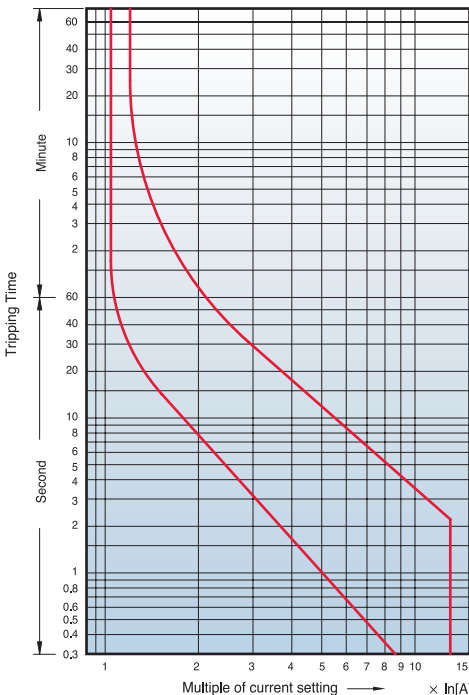

# Overload Relay Trip Curves

## Class 10A, 225AF

GT225S

Cold starting

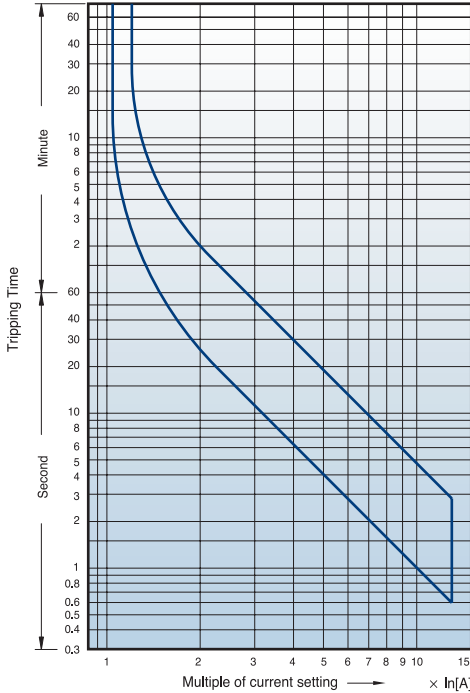

Hot starting

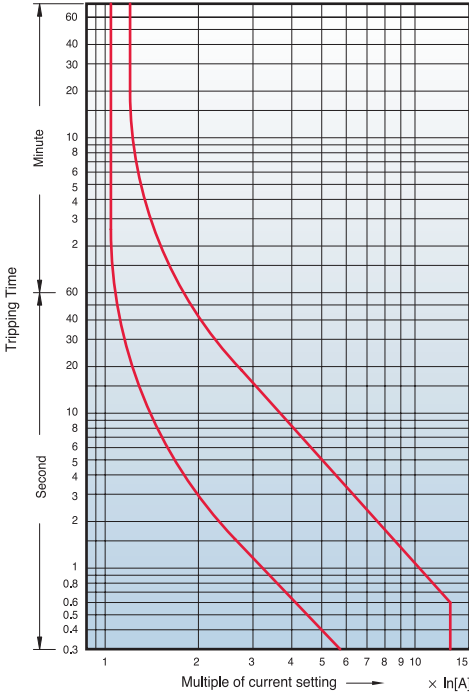

## Class 20, 225AF

GT225LS

Cold starting

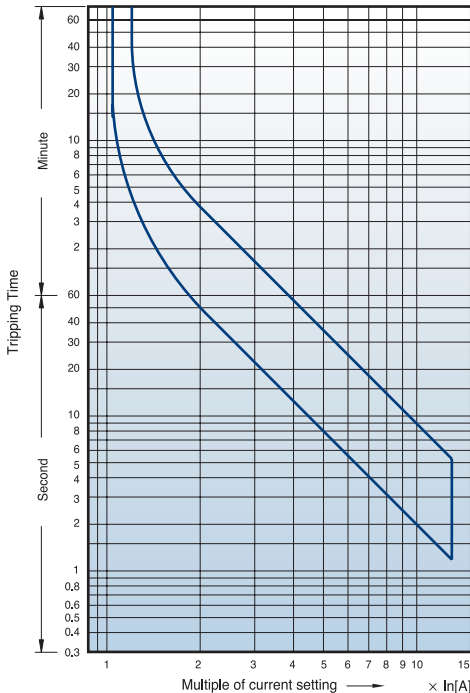

Hot starting

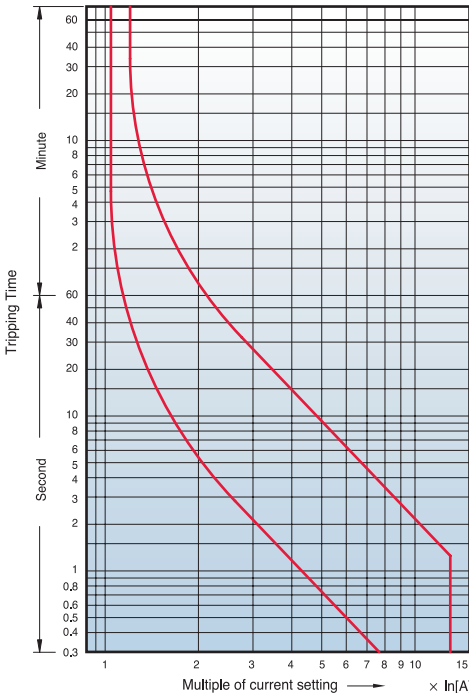

Specifications are subject to change without notice.

# Overload Relay Trip Curves

## Class 10A, 400AF

GT400S

Cold starting

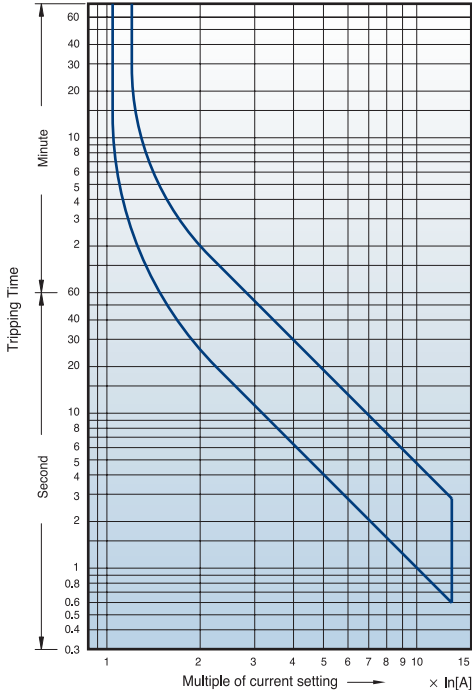

Hot starting

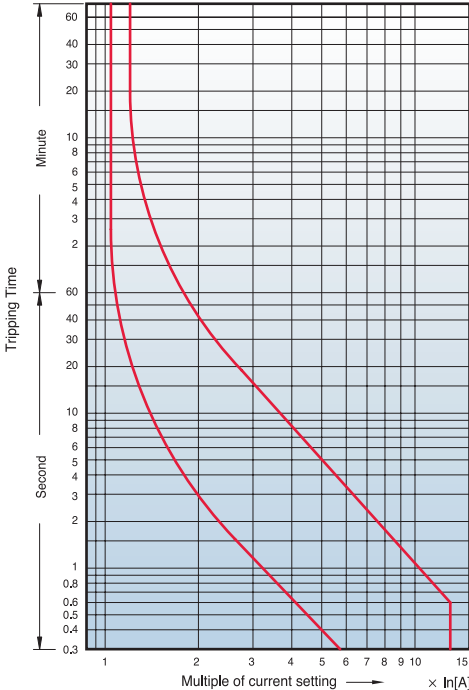

## Class 20, 400AF

GT400LS

Cold starting

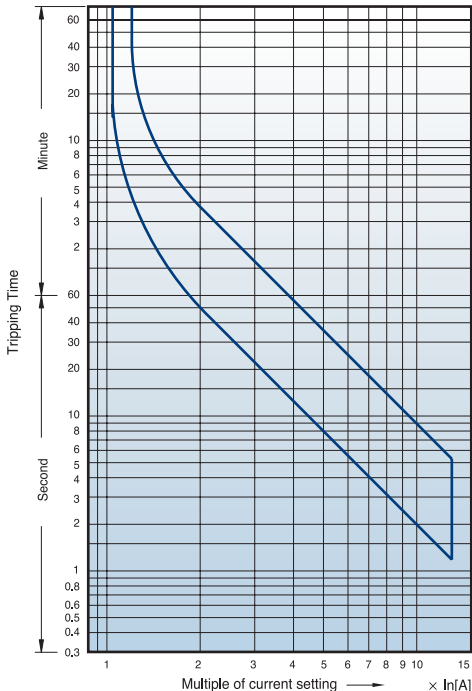

Hot starting

