

# GAS DISCHARGE TUBES (GDTs)

Littelfuse's GDTs (Gas Discharge Tubes) are placed in front of, and in parallel with, sensitive telecom equipment such as power lines, communication lines, signal lines and data transmission lines to help protect them from damage caused by transient surge voltages that may result from lightning strikes and equipment switching operations. These devices do not influence the signal in normal operation. However, in the event of an overvoltage surge, such as a lightning strike, the GDT switches to a low impedance state and diverts the energy away from the sensitive equipment.

Our GDTs offer a high level of surge protection, a broad voltage range, low capacitance, and many form factors including new surface mount devices, which makes them suitable for applications such as Main Distribution Frame (MDF) modules, high data-rate telecom applications (e.g. ADSL, VDSL), and surge protection on power lines. Their low capacitance also results in less signal distortion. When used in a coordinated circuit protection solution with PolySwitch devices, they can help equipment manufacturers meet stringent safety regulatory standards.

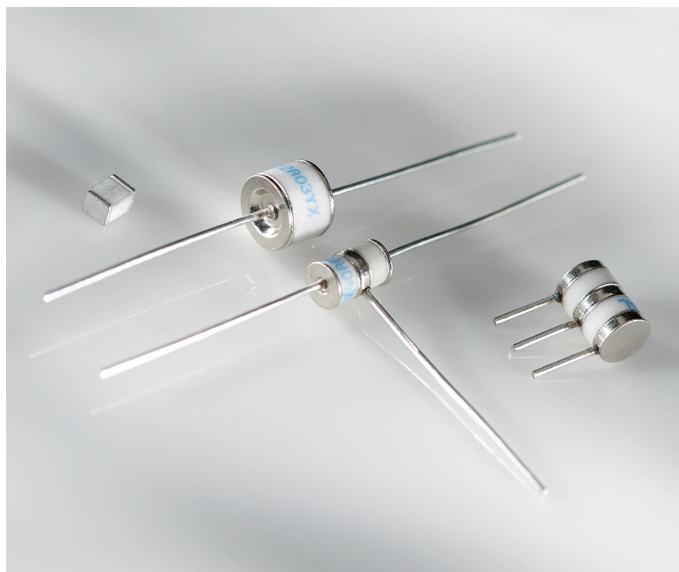

## BENEFITS

- Helps provide overvoltage fault protection against damage caused by high energy surges
- Suitable for use in sensitive equipment due to impulse sparkover response
- Suitable for high-frequency applications
- Highly reliable performance
- New surface-mount devices for automated manufacturing

## FEATURES

- RoHS compliant
- Halogen free (refers to: Br $\geq$ 900ppm, Cl $\geq$ 900ppm, Br+Cl $\geq$ 1500ppm)
- Wide range of voltages (75V-4000V)
- Wide range of form factors (3mm, 5mm, 6mm, 7mm, 8mm diameter devices)
- Low capacitance and insertion loss
- Crowbar device with low arc voltage
- High accuracy spark-over voltages for high precision designs

## APPLICATIONS

- Telecommunications
  - MDF modules, xDSL equipment, RF systems, antenna, base stations
- Industrial and Consumer Electronics
  - Power supplies, surge protectors, alarm systems, irrigation systems
- Devices tested per ITU K.12 recommendations
- Various lead configurations and surface-mount options
- Optional fail-short mechanism
- Non radioactive materials
- Devices certified to UL497B and UL1449

# Gas Discharge Tubes (GDTs)

## Figures G1-G2 – Typical Circuits for Gas Discharge Tubes



**Table G1 – Device Voltage Ratings, Surge Rating, Capacitance, Insulation Resistance and Agency Approval for Two-Electrode Gas Discharge Tubes**

| Part Number       | DC Sparkover Voltage        | Impulse Sparkover Voltage | Impulse Discharge Current                   |  | Impulse Withstanding Voltage                   | Capacitance | Insulation Resistance             | UL Rating       |
|-------------------|-----------------------------|---------------------------|---|--|--|-------------|-----------------------------------|-----------------|
|                   | @ 100V/s<br>± 20% Tolerance | @ 1kV/μs                  | 8x20μs<br>10 Hits<br>(5 Hits Each Polarity) | 8x20μs<br>300 Hits<br>(150 Hits Each Polarity) | 10/700μs<br>10 Hits<br>(5 Times Each Polarity) | @ 1MHz      | @ 100V <sub>DC</sub> <sup>†</sup> | UL497B #E179610 |
| GTCS23-XXXM-R01-2 | 75*                         | 600                       | 1kA   | 100A   | 4kV  | <0.5pF      | 1,000 (MΩ)                        | All Devices     |
|                   | 90                          | 600                       |   |  |  |             |                                   |                 |
|                   | 140                         | 600                       |   |  |  |             |                                   |                 |
|                   | 150                         | 600                       |   |  |  |             |                                   |                 |
| GTCC23-XXXM-R01-2 | 200                         | 700                       | 1kA   | 100A   | 6kV <sup>†</sup>                               | <0.5pF      | 1,000 (MΩ)                        | All Devices     |
|                   | 230                         | 700                       |   |  |  |             |                                   |                 |
|                   | 300                         | 900                       |   |  |  |             |                                   |                 |
|                   | 350                         | 1000                      |   |  |  |             |                                   |                 |
|                   | 400                         | 1000                      |   |  |  |             |                                   |                 |

\* DCSO 60-105

<sup>†</sup> Devices <=150V measured @ 50V<sub>DC</sub>

<sup>‡</sup> Effective output impedance: 40ohms

| Part Number       | DC Sparkover Voltage        | Impulse Sparkover Voltage |          | DC Holdover Voltage | On-State Voltage  | Impulse Discharge Current | Impulse Life          | AC Discharge Current (1s duration; 10 hits) | Capacitance        | Insulation Resistance | UL Rating       |
|-------------------|-----------------------------|---------------------------|----------|---------------------|-------------------|---------------------------|-----------------------|---|--------------------|-----------------------|-----------------|
|                   | @ 100V/s<br>± 20% Tolerance | @ 100V/μs                 | @ 1kV/μs | Per ITU K.12        | Nominal (@1A) (V) | 8x20μs<br>10 Hits         | 10x1000μs<br>300 Hits | @ 50 Hz                                     | @ 1MHz             | @ 100V <sub>DC</sub>  | UL497B #E179610 |
| GTCX25-XXXM-R02   | 75                          | 450                       | 550      | <52                 | 20                | 2.5kA                     | 100A                  | 2.5Arms                                     | <1pF               | 10,000 (MΩ)           | All Devices     |
|                   | 90                          | 450                       | 550      | <52                 | 20                |                           |                       |   |                    |                       |                 |
| GTCX26-XXXM-R05   | 140                         | 500                       | 600      | <80                 | 20                | 5kA                       | 100A                  | 5Arms                                       | <1pF               | 10,000 (MΩ)           | All Devices     |
|                   | 200                         | 600                       | 700      | <135                | 20                |                           |                       |   |                    |                       |                 |
|                   | 230                         | 600                       | 700      | <135                | 20                |                           |                       |   |                    |                       |                 |
| GTCX28-XXXM-R05   | 250                         | 600                       | 700      | <135                | 20                | 5kA                       | 100A                  | 5Arms                                       | <1pF               | 10,000 (MΩ)           | All Devices     |
|                   | 260                         | 700                       | 800      | <135                | 20                |                           |                       |   |                    |                       |                 |
|                   | 300                         | 800                       | 900      | <150                | 20                |                           |                       |   |                    |                       |                 |
| GTCX28-XXXM-R10   | 350                         | 900                       | 1000     | <150                | 20                | 10kA                      | 100A                  | 10Arms                                      | <1pF <sup>††</sup> | 10,000 (MΩ)           | All Devices     |
|                   | 400                         | 900                       | 1000     | <150                | 20                |                           |                       |   |                    |                       |                 |
|                   | 420                         | 900                       | 1000     | <150                | 20                |                           |                       |   |                    |                       |                 |
|                   | 470                         | 1050                      | 1150     | <150                | 20                |                           |                       |   |                    |                       |                 |
|                   | 500                         | 1100                      | 1200     | <150                | 20                |                           |                       |   |                    |                       |                 |
| GTCX28-XXXM-R20** | 550                         | 1300                      | 1400     | <150                | 20                | 20kA                      | 100A                  | 20Arms                                      | <1.5pF             | 10,000 (MΩ)           | All Devices     |
|                   | 600                         | 1300                      | 1400     | <150                | 20                |                           |                       |   |                    |                       |                 |

\*\* GTCX28-XXXM-R20 parts only up to 350V

<sup>††</sup> <1.2pF for 75V and 90V devices.

## Gas Discharge Tubes (GDTs)

**Table G2 – Device Voltage Ratings, Surge Rating, Capacitance, Insulation Resistance and Agency Approval for Two Electrode High-Voltage Gas Discharge Tubes**

| Part Number     | DC Sparkover Voltage     | Impulse Sparkover Voltage | Impulse Life          | AC Discharge Current, 50Hz |                                      | Impulse Discharge Current 8/20µs |                                | Capacitance @ 1MHz | UL Rating         |
|-----------------|--------------------------|---------------------------|-----------------------|----------------------------|--------------------------------------|----------------------------------|--------------------------------|--------------------|-------------------|
|                 | @ 100V/s ± 20% Tolerance | @ 100V/µs                 |                       | 10/1000µs 100A             | Multiple Hits (1s Duration: 10 Hits) | Single Hit, 9 Cycles             | 10 Hits (5 Hits Each Polarity) |                    |                   |
| GTCA28-801M-R05 | 800                      | 1400                      | 300 times             | 5A                         | N/A                                  | 5kA                              | N/A                            | <1pF               | UL1449 #E332226 ✓ |
| GTCA28-102M-R03 | 1000                     | 1700                      | N/A                   | 1A                         | 5A                                   | 3kA                              | 10kA                           | <1pF               | ✓                 |
| GTCA28-122M-R03 | 1200                     | 1900                      | N/A                   | 1A                         | 5A                                   | 3kA                              | 10kA                           | <1pF               | ✓                 |
| GTCA28-152L-R03 | 1500 (± 15%)             | 2200                      | N/A                   | 1A                         | 5A                                   | 3kA                              | 10kA                           | <1pF               | ✓                 |
| GTCA28-212M-R03 | 2100                     | 2700                      | N/A                   | 1A                         | 5A                                   | 3kA                              | 10kA                           | <1pF               | ✓                 |
| GTCA28-242M-R03 | 2400                     | 3300                      | N/A                   | 1A                         | 5A                                   | 3kA                              | 10kA                           | <1pF               | ✓                 |
| GTCA28-252M-R03 | 2500                     | 3500                      | N/A                   | 1A                         | 5A                                   | 3kA                              | 10kA                           | <1pF               | ✓                 |
| GTCA28-272L-R03 | 2700 (± 15%)*            | 3700                      | 300Times <sup>†</sup> | N/A                        | N/A                                  | 3kA                              | 10kA                           | <1pF               | ✓                 |
| GTCA28-302M-R03 | 3000                     | 4000                      | N/A                   | 1A                         | 5A                                   | 3kA                              | 10kA                           | <1pF               | ✓                 |
| GTCA28-312L-R03 | 3100 (± 15%)*            | 3700 <sup>†</sup>         | 300Times <sup>†</sup> | N/A                        | N/A                                  | 3kA                              | 10kA                           | <1pF               | ✓                 |
| GTCA28-362M-R03 | 3600                     | 4600                      | N/A                   | 1A                         | 5A                                   | 3kA                              | 10kA                           | <1pF               | ✓                 |
| GTCA28-402M-R03 | 4000                     | 5000                      | N/A                   | 1A                         | 5A                                   | 3kA                              | 10kA                           | <1pF               | ✓                 |

**Table G3 – Device Voltage Ratings, Surge Rating, Capacitance, Insulation Resistance and Agency Approval for Three-Electrode Gas Discharge Tubes**

| Part Number     | DC Sparkover Voltage (A-E) (B-E) | Impulse Sparkover Voltage (A-E) (B-E) |          | DC Holdover Voltage | On-State Voltage  | Impulse Discharge Current (A+B-E) | Impulse Life (A+B-E) | AC Discharge Current (1s duration; 10 hits) (A+B-E) | Capacitance | Insulation Resistance  | UL Rating       |
|-----------------|----------------------------------|---------------------------------------|----------|---------------------|-------------------|-----------------------------------|----------------------|---|-------------|------------------------|-----------------|
|                 | @ 100V/s ± 20% Tolerance         | @ 100V/µs                             | @ 1kV/µs | Per ITU K.12        | Nominal (@1A) (V) | 8x20µs 10 Hits                    | 10x1000µs 300 Hits   | @ 50 Hz   | @ 1MHz      | @ 100V <sub>DC</sub> * | UL497B #E179610 |
| GTCX35-XXXM-R05 | 75                               | 450                                   | 550      | <52                 | 20                | 5kA                               | 100A                 | 5Arms   | <1pF        | 10,000 (MΩ)            | All Devices     |
|                 | 90                               | 450                                   | 550      | <52                 | 20                |                                   |                      |   |             |                        |                 |
| GTCX36-XXXM-R05 | 140                              | 500                                   | 600      | <80                 | 20                | 5kA                               | 200A                 | 5Arms   | <1pF        | 10,000 (MΩ)            | All Devices     |
|                 | 150                              | 500                                   | 600      | <80                 | 20                |                                   |                      |   |             |                        |                 |
| GTCX36-XXXM-R10 | 200                              | 600                                   | 700      | <135                | 20                | 10kA                              | 200A                 | 10Arms  | <1pF        | 10,000 (MΩ)            | All Devices     |
|                 | 230                              | 600                                   | 700      | <135                | 20                |                                   |                      |   |             |                        |                 |
|                 | 250                              | 600                                   | 700      | <135                | 20                |                                   |                      |   |             |                        |                 |
| GTCX37-XXXM-R10 | 260                              | 700                                   | 800      | <135                | 20                | 10kA                              | 200A                 | 10Arms  | <1pF        | 10,000 (MΩ)            | All Devices     |
|                 | 300                              | 800                                   | 900      | <150                | 20                |                                   |                      |   |             |                        |                 |
|                 | 350                              | 900                                   | 1000     | <150                | 20                |                                   |                      |   |             |                        |                 |
|                 | 400                              | 900                                   | 1000     | <150                | 20                |                                   |                      |   |             |                        |                 |
| GTCX38-XXXM-R10 | 420                              | 900                                   | 1000     | <150                | 20                | 10kA                              | 200A                 | 10Arms  | <1pF        | 10,000 (MΩ)            | All Devices     |
|                 | 470                              | 1050                                  | 1150     | <150                | 20                |                                   |                      |   |             |                        |                 |
|                 | 500                              | 1100                                  | 1200     | <150                | 20                |                                   |                      |   |             |                        |                 |
| GTCX38-XXXM-R10 | 550                              | 1300                                  | 1400     | <150                | 20                | 10kA                              | 200A                 | 10Arms  | <1pF        | 10,000 (MΩ)            | All Devices     |
|                 | 600                              | 1300                                  | 1400     | <150                | 20                |                                   |                      |   |             |                        |                 |

\* Insulation resistance measured at 50V for devices less than 150V.  
Insulation resistance measured at 250V for devices more than 500V.

# Gas Discharge Tubes (GDTs)

## Figures G3-G11 – Dimensions for Gas Discharge Tubes

### Figure G3 – Two Electrode 3mm Product Dimensions

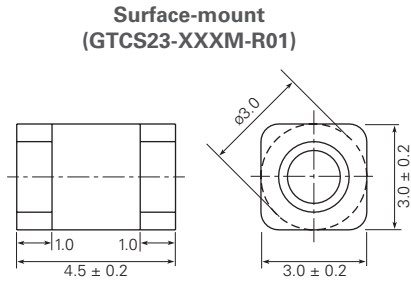

**Pad Layout - Surface-mount Devices  
(GTCS23-XXXM-R01)**



|     | <b>X<br/>Nom</b> | <b>Y<br/>Nom</b> | <b>Z1<br/>Nom</b> | <b>Z2<br/>Nom</b> |
|-----|------------------|------------------|-------------------|-------------------|
| mm  | 3.0              | 2.0              | 2.0               | 2.0               |
| in* | 0.118            | 0.079            | 0.079             | 0.079             |

\* The dimensions in inches are rounded approximations.

**Chip GDT  
(GTCC23-XXXM-R01)**

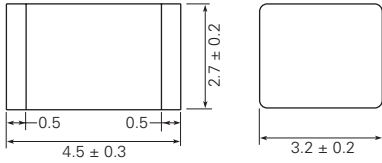

**Pad Layout - Chip GDT Devices  
(GTCC23-XXXM-R01)**

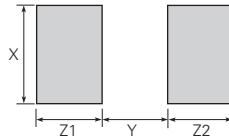

|     | <b>X<br/>Nom</b> | <b>Y<br/>Nom</b> | <b>Z1<br/>Nom</b> | <b>Z2<br/>Nom</b> |
|-----|------------------|------------------|-------------------|-------------------|
| mm  | 3.5              | 2.7              | 2.0               | 2.0               |
| in* | 0.138            | 0.106            | 0.079             | 0.079             |

\* The dimensions in inches are rounded approximations.

### Figure G4 – Two Electrode 5mm Product Dimensions

**Axial Leads  
(GTCA25-XXXM-R02)**

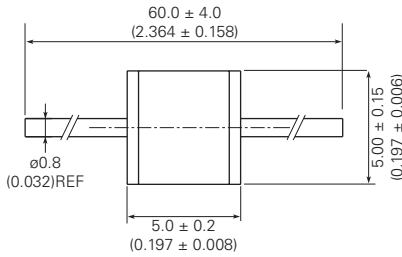

**No Leads  
(GTCN25-XXXM-R02)†**

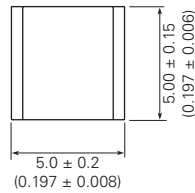

**Surface-mount  
(GTCS25-XXXM-R02)**

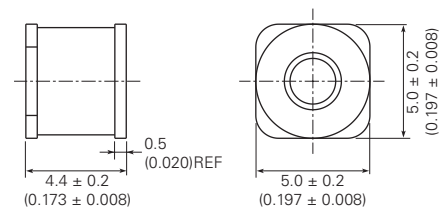

**Pad Layout - Surface-mount Devices  
(GTCS25-XXXM-R02)**

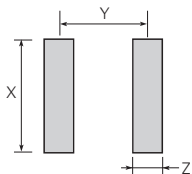

|     | <b>X<br/>Nom</b> | <b>Y<br/>Nom</b> | <b>Z<br/>Nom</b> |
|-----|------------------|------------------|------------------|
| mm  | 6.0              | 3.9              | 1.3              |
| in* | 0.236            | 0.154            | 0.051            |

\* The dimensions in inches are rounded approximations.

† Parts with no leads are not solderable and are meant for insertion into magazine clips.

# Gas Discharge Tubes (GDTs)

## Figures G3-G11 — Dimensions for Gas Discharge Tubes

(Cont'd)

### Figure G5 — Two Electrode 6mm Product Dimensions

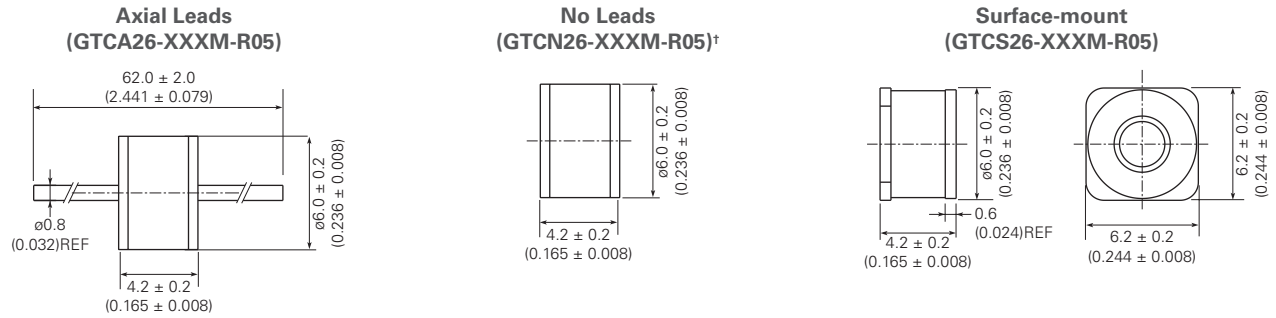

#### Pad Layout - Surface-mount Devices (GTCS26-XXXM-R05)



|     | X<br>Nom | Y<br>Nom | Z<br>Nom |
|-----|----------|----------|----------|
| mm  | 7.0      | 3.7      | 1.3      |
| in* | 0.276    | 0.146    | 0.051    |

\* The dimensions in inches are rounded approximations.  
<sup>†</sup> Parts with no leads are not solderable and are meant for insertion into magazine clips.

### Figure G6 — Two Electrode 8mm Product Dimensions

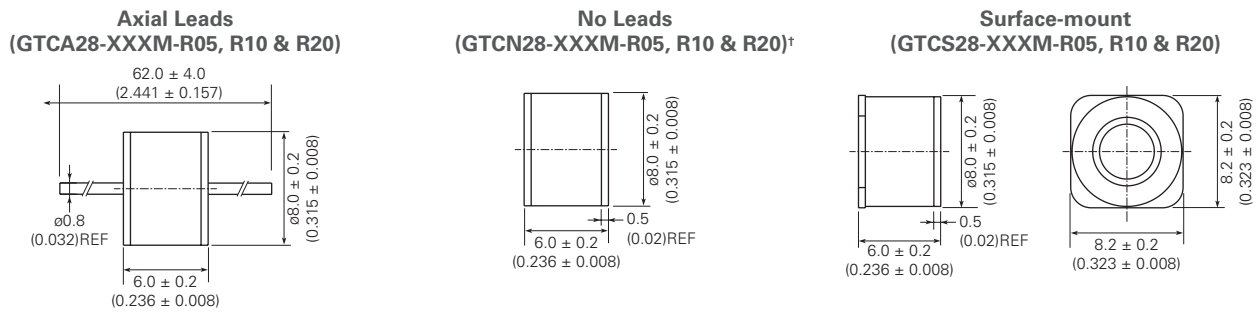

#### Pad Layout - Surface-mount Devices (GTCS28-XXXM-R05, R10 & R20)

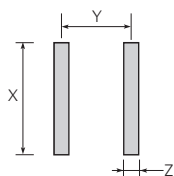

|     | X<br>Nom | Y<br>Nom | Z<br>Nom |
|-----|----------|----------|----------|
| mm  | 9.0      | 5.6      | 1.2      |
| in* | 0.354    | 0.22     | 0.047    |

\* The dimensions in inches are rounded approximations.  
<sup>†</sup> Parts with no leads are not solderable and are meant for insertion into magazine clips.

### Figure G7 — Two Electrode 8mm High Voltage Product Dimensions

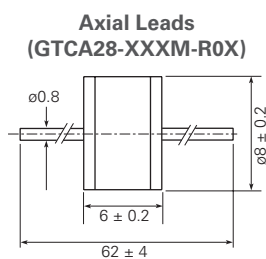

# Gas Discharge Tubes (GDTs)

## Figures G3-G11 — Dimensions for Gas Discharge Tubes

(Cont'd)

### Figure G8 — Three Electrode 5mm Product Dimensions

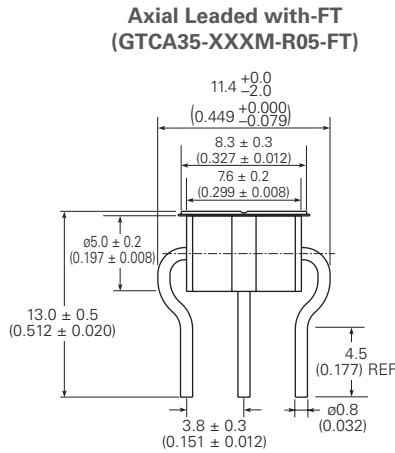

Dimensions in these drawings are in millimeters (inches)

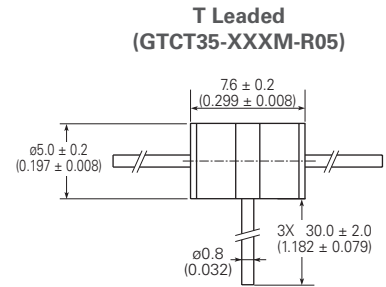
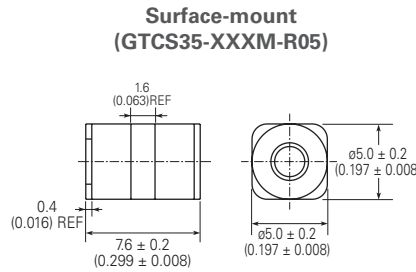
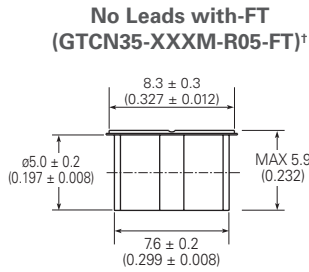

### Pad Layout - Surface-mount Devices (GTCS35-XXXM-R05)



|     | <b>X</b>   | <b>Y1</b>  | <b>Y2</b>  | <b>Z1</b>  | <b>Z2</b>  |
|-----|------------|------------|------------|------------|------------|
|     | <b>Nom</b> | <b>Nom</b> | <b>Nom</b> | <b>Nom</b> | <b>Nom</b> |
| mm  | 6.0        | 3.6        | 3.6        | 2.5        | 1.3        |
| in* | 0.236      | 0.142      | 0.142      | 0.098      | 0.051      |

\* The dimensions in inches are rounded approximations.

† Parts with no leads are not solderable and are meant for insertion into magazine clips.

# Gas Discharge Tubes (GDTs)

## Figures G3-G11 — Dimensions for Gas Discharge Tubes

(Cont'd)

### Figure G9 — Three Electrode 6mm Product Dimensions

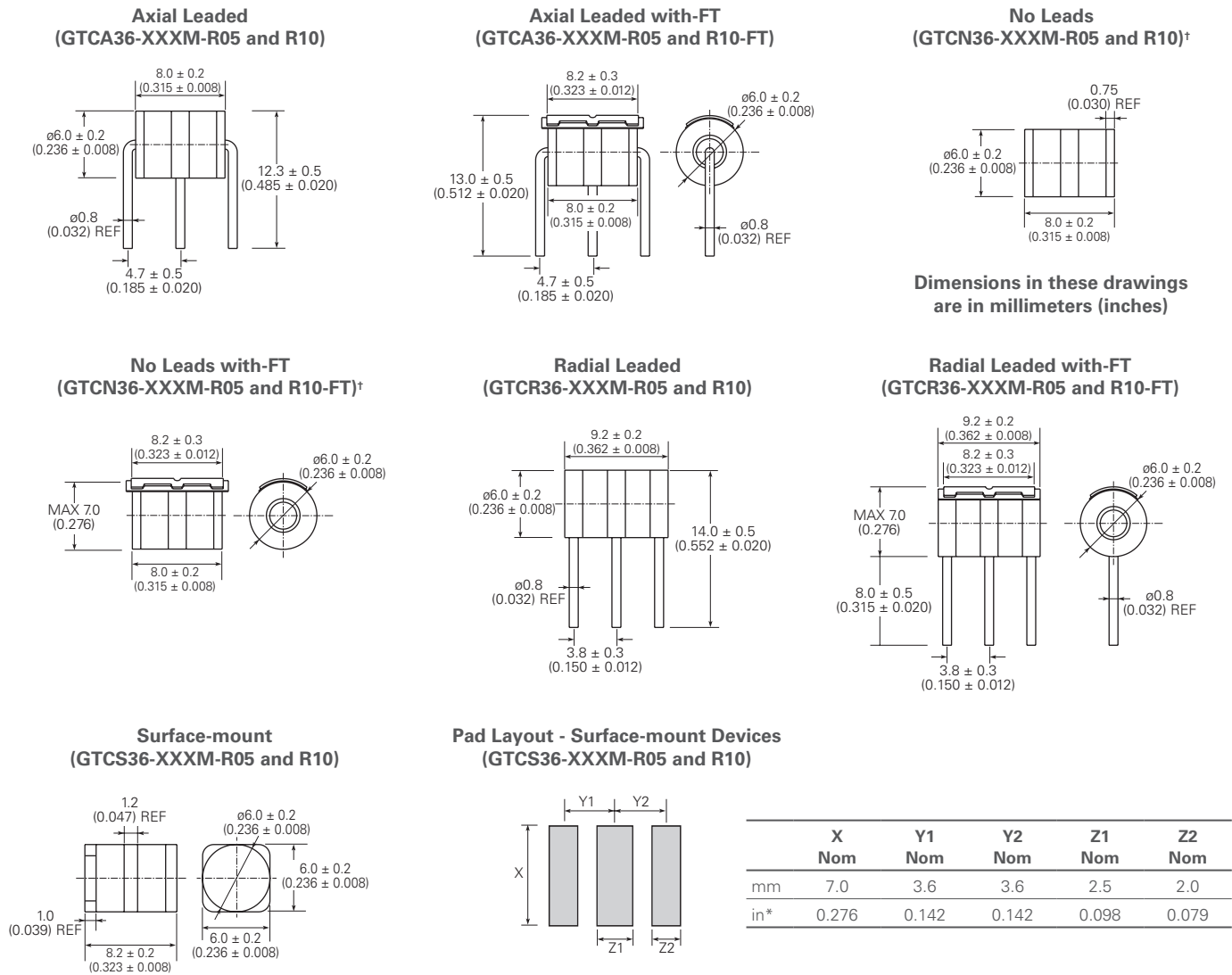

\* The dimensions in inches are rounded approximations.

† Parts with no leads are not solderable and are meant for insertion into magazine clips.

### Figure G10 — Three Electrode 7mm Product Dimensions

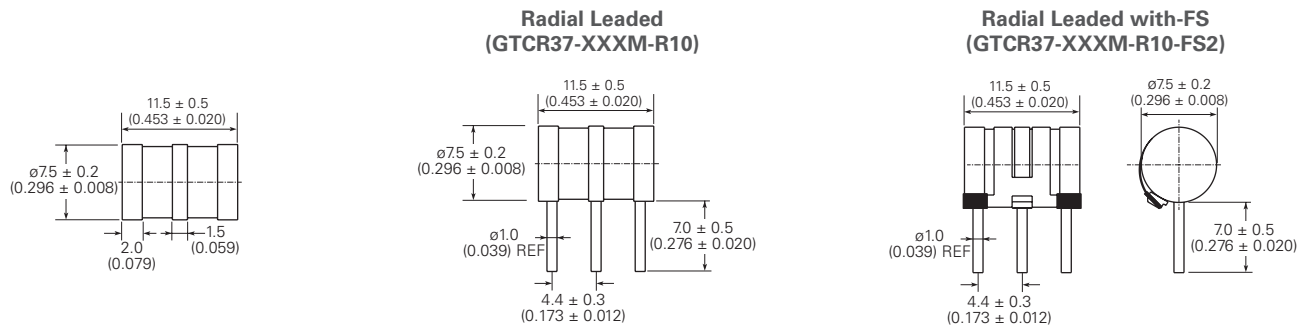

† Parts with no leads are not solderable and are meant for insertion into magazine clips.

# Gas Discharge Tubes (GDTs)

## Figures G3-G11 — Dimensions for Gas Discharge Tubes

(Cont'd)

### Figure G11 — Three Electrode 8mm Product Dimensions

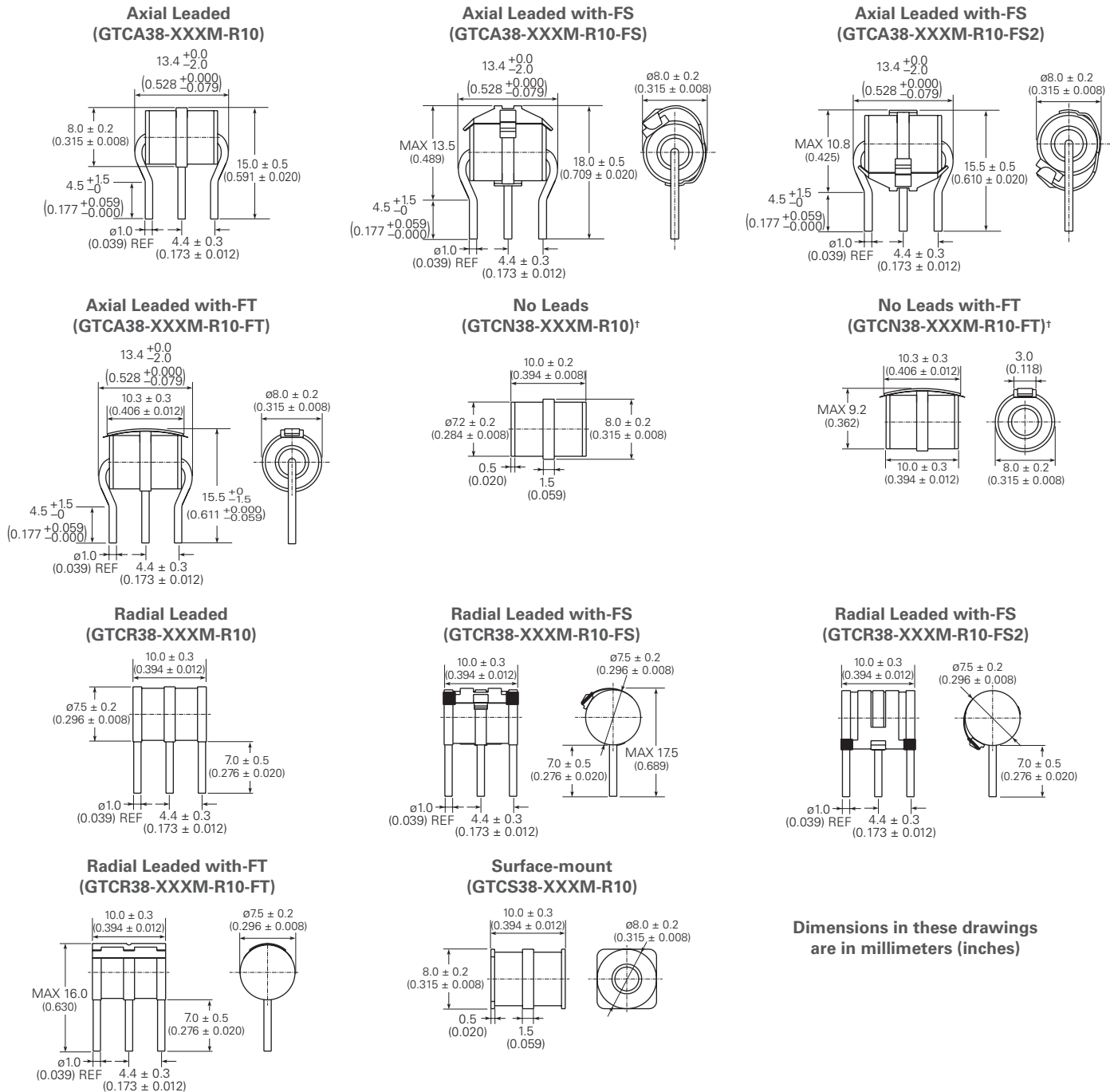

#### Pad Layout - Surface-mount Devices (GTCR38-XXXM-R10)

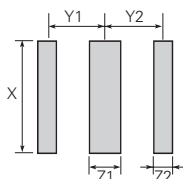

|     | X<br>Nom | Y1<br>Nom | Y2<br>Nom | Z1<br>Nom | Z2<br>Nom |
|-----|----------|-----------|-----------|-----------|-----------|
| mm  | 9.0      | 4.65      | 4.65      | 2.5       | 1.5       |
| in* | 0.354    | 0.183     | 0.183     | 0.098     | 0.059     |

\* The dimensions in inches are rounded approximations.

† Parts with no leads are not solderable and are meant for insertion into magazine clips.



# Gas Discharge Tubes (GDTs)

## Fail-Short Mechanism for Gas Discharge Tubes

### Fail-Short Mechanism – FS

The FS fail-short mechanism is a short circuit spring mounted onto a solder pellet located at the center electrode of the gas tube. Under normal operating conditions, the pellet is positioned to make the spring float above the outer electrodes, as shown in Figure G11 on the previous page.

When a prolonged discharge event causes the gas tube temperature to reach the melting point of the solder, the pellet softens allowing the short circuit spring to contact with both outer electrodes (Figure G12). This process results in a permanent short circuit between all three electrodes creating a low resistance path that conducts the fault current to ground without generating a significant amount of heat.



### Fail-Short Mechanism – FT

The FT fail-short mechanism is a short circuit spring with a piece of plastic foil spot welded onto the center electrode. Under normal operating conditions, the plastic foil makes the spring insulated from the two outer electrodes.

When a prolonged discharge event causes the gas tube temperature to reach the melting point of the plastic foil, the plastic foil melts allowing the short circuit spring to contact both outer electrodes (Figure G13). This process results in a permanent short circuit between all three electrodes creating a low resistance path that conducts the fault current to ground without generating a significant amount of heat.

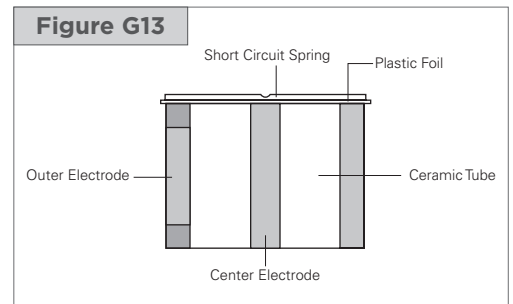

## Operation and Storage Temperatures for Gas Discharge Tubes

### Operation Temperature Range

Models without Fail-Short Mechanism : -40°C/+90°C  
 Models with Fail-Short Mechanism : -20°C/+65°C

### Storage Temperature Range

Models without Fail-Short Mechanism : -40°C/+90°C  
 Models with Fail-Short Mechanism : -20°C/+65°C

## Packaging Information for Gas Discharge Tubes

| Part Description        | Parts in Bulk      |              | Parts in Tape and Reel           |              |
|-------------------------|--------------------|--------------|----------------------------------|--------------|
|                         | Min Order Quantity | Box Quantity | Tape and Reel Min Order Quantity | Box Quantity |
| 3mm 2Pole Surface-mount | —                  | —            | 2000                             | 16000        |
| 5mm 2Pole No leads      | 5000               | 20000        | —                                | —            |
| 5mm 2Pole Leads         | 1000               | 5000         | —                                | —            |
| 5mm 2Pole Surface-mount | —                  | —            | 1500                             | 12000        |
| 6mm 2Pole No leads      | 2000               | 10000        | —                                | —            |
| 6mm 2Pole Leads         | 1000               | 5000         | —                                | —            |
| 6mm 2Pole Surface-mount | —                  | —            | 750                              | 6000         |
| 8mm 2pole No leads      | 2000               | 10000        | —                                | —            |
| 8mm 2Pole Leads         | 1000               | 5000         | —                                | —            |
| 8mm 2Pole Surface-mount | —                  | —            | 500                              | 4000         |
| 5mm 3Pole No leads      | 2500               | 10000        | —                                | —            |
| 5mm 3Pole Leads         | 1000               | 5000         | —                                | —            |
| 5mm 3Pole Surface-mount | —                  | —            | 1000                             | 8000         |
| 6mm 3Pole No leads      | 2500               | 10000        | —                                | —            |
| 6mm 3Pole Leads         | 1000               | 5000         | —                                | —            |
| 6mm 3Pole Surface-mount | —                  | —            | 750                              | 4500         |
| 7mm 3Pole Leads         | 1000               | 5000         | —                                | —            |
| 8mm 3Pole No leads      | 1000               | 5000         | —                                | —            |
| 8mm 3Pole Leads         | 1000               | 5000         | —                                | —            |
| 8mm 3Pole Surface-mount | —                  | —            | 500                              | 2500         |

## Gas Discharge Tubes (GDTs)

### Installation for Gas Discharge Tubes

Care should be taken when installing GDTs equipped with fail-short mechanisms into arrester magazines, printed circuit boards, etc. Too much downward pressure may force the short circuit spring through the thin insulation tube creating a shorted condition.

### Solder Reflow Recommendations for Surface-mount GDT Devices

Surface-mount GDTs can be soldered using standard Pb-free reflow profiles.

Table G4 – Tape and Reel Specifications

| Tape Dimension<br>EIA Mark | 3mm devices (2 pole)<br>Dimension (mm) | 5mm devices (2 pole)<br>Dimension (mm) | 6mm devices (2 pole)<br>Dimension (mm) | 8mm devices (2 pole)<br>Dimension (mm) |
|----------------------------|--|--|--|--|
| A <sub>0</sub>             | 3.40±0.10                              | 4.9±0.10                               | 6.70±0.10                              | 8.60±0.10                              |
| B <sub>0</sub>             | 5.00±0.10                              | 5.5±0.10                               | 4.60±0.10                              | 6.40±0.10                              |
| D <sub>0</sub>             | 1.50+0.10/-0                           | 1.50+0.10/-0                           | 1.50+0.10/-0                           | 1.50+0.10/-0                           |
| D <sub>1</sub>             | —                                      | 1.5 MIN                                | —                                      | —                                      |
| E <sub>1</sub>             | 1.75±0.10                              | 1.75±0.10                              | 1.75±0.10                              | 1.75±0.10                              |
| E <sub>2</sub>             | 14.25±0.30                             | 14.25±0.30                             | 14.25±0.30                             | 14.25±0.30                             |
| F                          | 7.50±0.10                              | 7.50±0.10                              | 7.50±0.10                              | 7.50±0.10                              |
| P <sub>0</sub>             | 4.00±0.10                              | 4.00±0.10                              | 4.00±0.10                              | 4.00±0.10                              |
| P <sub>1</sub>             | 8.00±0.10                              | 8.00±0.10                              | 12.00±0.10                             | 12.00±0.10                             |
| P <sub>2</sub>             | 2.00±0.10                              | 2.00±0.10                              | 2.00±0.10                              | 2.00±0.10                              |
| W                          | 16.00±0.30                             | 16.00±0.30                             | 16.00±0.30                             | 16.00±0.30                             |
| Tape Thickness<br>EIA Mark | Dimension (mm)                         | Dimension (mm)                         | Dimension (mm)                         | Dimension (mm)                         |
| B <sub>1</sub>             | —                                      | —                                      | —                                      | —                                      |
| K <sub>0</sub>             | 3.30±0.10                              | 5.30±0.10                              | 6.50±0.10                              | 8.50±0.10                              |
| T                          | 0.35±0.05                              | 0.40±0.05                              | 0.35±0.05                              | 0.50±0.05                              |
| T <sub>1</sub>             | —                                      | —                                      | —                                      | —                                      |
| T <sub>2</sub>             | —                                      | —                                      | —                                      | —                                      |
| Reel Dimension<br>EIA Mark | Dimension (mm)                         | Dimension (mm)                         | Dimension (mm)                         | Dimension (mm)                         |
| A                          | 330                                    | 330                                    | 330                                    | 330                                    |
| B                          | 2.20±0.50                              | 2.20±0.50                              | 2.20±0.50                              | 2.20±0.50                              |
| C                          | 13.00±0.20                             | 13.00±0.20                             | 13.00±0.20                             | 13.00±0.20                             |
| D                          | 20.20±1.00                             | 20.20±1.00                             | 20.20±1.00                             | 20.20±1.00                             |
| N                          | 100.00±1.00                            | 100.00±1.00                            | 100.00±1.00                            | 100.00±1.00                            |
| W <sub>1</sub>             | 16.50±0.10                             | 16.50±0.10                             | 16.50±0.10                             | 16.50±0.10                             |
| W <sub>2</sub>             | 21.10±02.00                            | 21.10±02.00                            | 21.10±02.00                            | 21.10±02.00                            |

Figure G14 – EIA Referenced Taped Component Dimensions



# Gas Discharge Tubes (GDTs)

## Table G5 – Tape and Reel Specifications

| Tape Dimension<br>EIA Mark | 5mm devices (3 pole)<br>Dimension (mm) | 6mm devices (3 pole)<br>Dimension (mm) | 8mm devices (3 pole)<br>Dimension (mm) |
|----------------------------|--|--|--|
| A <sub>0</sub>             | 5.40±0.10                              | 6.50±0.10                              | 8.50±0.10                              |
| B <sub>0</sub>             | 8.00±0.10                              | 8.60±0.10                              | 10.60±0.10                             |
| D <sub>0</sub>             | 1.50+0.10/-0                           | 1.50+0.10/-0                           | 1.50+0.10/-0                           |
| D <sub>1</sub>             | 1.50(min)                              | 1.50(min)                              | —                                      |
| E <sub>1</sub>             | 1.75±0.10                              | 1.75±0.10                              | 1.75±0.10                              |
| E <sub>2</sub>             | 14.25±0.30                             | 22.25±0.30                             | 22.25±0.30                             |
| F                          | 7.50±0.10                              | 11.50±0.10                             | 11.50±0.10                             |
| P <sub>0</sub>             | 4.00±0.10                              | 4.00±0.10                              | 4.00±0.10                              |
| P <sub>1</sub>             | 8.00±0.10                              | 12.00±0.10                             | 16.00±0.10                             |
| P <sub>2</sub>             | 2.00±0.10                              | 2.00±0.10                              | 2.00±0.10                              |
| W                          | 16.00±0.30                             | 24.00±0.30                             | 24.00±0.30                             |
| Tape Thickness<br>EIA Mark | Dimension (mm)                         | Dimension (mm)                         | Dimension (mm)                         |
| B <sub>1</sub>             | —                                      | —                                      | —                                      |
| K <sub>0</sub>             | 5.70±0.10                              | 6.30±0.10                              | 8.40±0.10                              |
| T                          | 0.50±0.05                              | 0.50±0.05                              | 0.50±0.05                              |
| T <sub>1</sub>             | —                                      | —                                      | —                                      |
| T <sub>2</sub>             | —                                      | —                                      | —                                      |
| Reel Dimension<br>EIA Mark | Dimension (mm)                         | Dimension (mm)                         | Dimension (mm)                         |
| A                          | 330                                    | 330                                    | 330                                    |
| B                          | 2.20±0.50                              | 2.20±0.50                              | 2.20±0.50                              |
| C                          | 13.00±0.20                             | 13.00±0.20                             | 13.00±0.20                             |
| D                          | 20.20±1.00                             | 20.20±1.00                             | 20.20±1.00                             |
| N                          | 100.00±1.00                            | 100.00±1.00                            | 100.00±1.00                            |
| W <sub>1</sub>             | 16.50±0.10                             | 24.50±0.10                             | 24.50±0.10                             |
| W <sub>2</sub>             | 21.10±02.00                            | 29.10±02.00                            | 29.10±02.00                            |
| W <sub>3</sub>             | —                                      | —                                      | —                                      |

## Figure G15 – EIA Referenced Reel Dimensions

