

# GTRA384802FC

Thermally-Enhanced High Power RF GaN on SiC HEMT  
400 W, 48 V, 3600 – 3800 MHz

## Description

The GTRA384802FC is a 400-watt ( $P_{3dB}$ ) GaN on SiC high electron mobility transistor (HEMT) for use in multi-standard cellular power amplifier applications. It features input and output matching, high efficiency, and a thermally-enhanced package with earless flange.



GTRA384802FC  
Package H-37248C-4

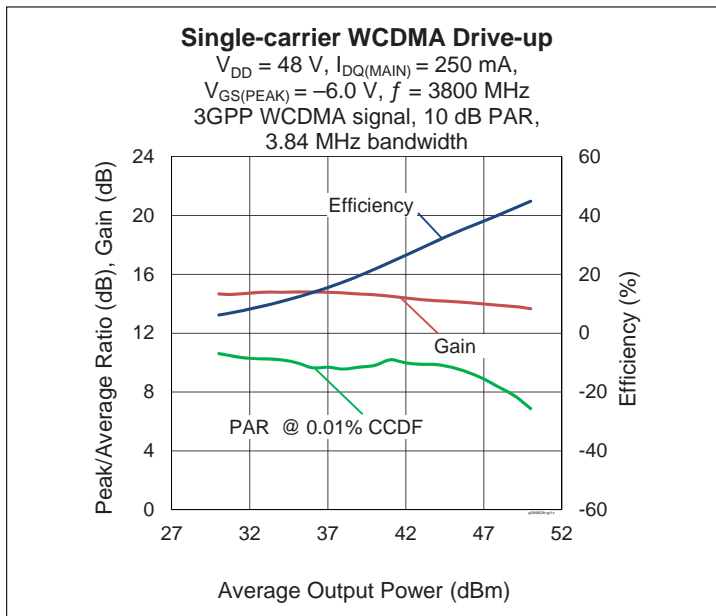

## Features

- GaN on SiC HEMT technology
- Asymmetric Doherty design
  - Main:  $P_{3dB} = 200\text{ W typ}$
  - Peak:  $P_{3dB} = 280\text{ W typ}$
- Typical pulsed CW performance, 3800 MHz, 48 V, combined outputs, Doherty @  $P_{3dB}$ , 10  $\mu\text{s}$ , 10% duty cycle
  - Output power = 400 W
  - Drain efficiency = 62%
  - Gain = 12 dB
- Capable of handling 10:1 VSWR at 48 V, 63 W (WCDMA) output power
- Human Body Model Class 1B (per ANSI/ESDA/JEDEC JS-001)
- Pb-free and RoHS compliant

## RF Characteristics

**Single-carrier WCDMA Specifications** (tested in Wolfspeed Doherty test fixture)

$V_{DD} = 48\text{ V}$ ,  $I_{DQ} = 250\text{ mA}$ ,  $P_{OUT} = 63\text{ W avg}$ ,  $V_{GS(PEAK)} = -6\text{ V}$ ,  $f = 3800\text{ MHz}$ , channel bandwidth = 3.84 MHz, peak/average = 10 dB @ 0.01% CCDF

Characteristic	Symbol	Min	Typ	Max	Unit
Gain	$G_{ps}$	12	13	—	dB
Drain Efficiency	$\eta_D$	38.5	42	—	%
Adjacent Channel Power Ratio	ACPR	—	-33	-29	dBc
Output PAR @ 0.01% CCDF	OPAR	7.3	7.8	—	dB

All published data at  $T_{CASE} = 25^\circ\text{C}$  unless otherwise indicated

ESD: Electrostatic discharge sensitive device—observe handling precautions!

## DC Characteristics

Characteristic	Conditions	Symbol	Min	Typ	Max	Unit
Drain-source Breakdown Voltage	(main) $V_{GS} = -8\text{ V}, I_D = 10\text{ mA}$	$V_{(BR)DSS}$	150	—	—	V
	(peak) $V_{GS} = -8\text{ V}, I_D = 10\text{ mA}$	$V_{(BR)DSS}$	150	—	—	V
Drain-source Leakage Current	$V_{GS} = -8\text{ V}, V_{DS} = 10\text{ V}$	$I_{DSS}$	—	—	5	mA
Gate Threshold Voltage	(main) $V_{DS} = 10\text{ V}, I_D = 25\text{ mA}$	$V_{GS(th)}$	-3.8	-3	-2.3	V
	(peak) $V_{DS} = 10\text{ V}, I_D = 36\text{ mA}$	$V_{GS(th)}$	-3.8	-3	-2.3	V

## Recommended Operating Voltages

Parameter	Conditions	Symbol	Min	Typ	Max	Unit
Drain Operating Voltage		$V_{DD}$	0	—	50	V
Gate Quiescent Voltage	$V_{DS} = 48\text{ V}, I_D = 250\text{ mA}$	$V_{GS(Q)}$	-3.9	-2.9	-2.0	V

## Absolute Maximum Ratings

Parameter	Symbol	Value	Unit
Drain-source Voltage	$V_{DSS}$	125	V
Gate-source Voltage	$V_{GS}$	-10 to +2	V
Operating Voltage	$V_{DD}$	55	V
Gate Current	(main)	$I_G$	25.2 mA
	(peak)	$I_G$	36 mA
Drain Current	(main)	$I_D$	9.5 A
	(peak)	$I_D$	13.5 A
Junction Temperature	$T_J$	225	°C
Storage Temperature Range	$T_{STG}$	-65 to +150	°C

Operation above the maximum values listed here may cause permanent damage. Maximum ratings are absolute ratings; exceeding only one of these values may cause irreversible damage to the component. Exposure to absolute maximum rating conditions for extended periods may affect device reliability. For reliable continuous operation, the device should be operated within the operating voltage range ( $V_{DD}$ ) specified above.

## Thermal Characteristics

Parameter	Symbol	Value	Unit
Thermal Resistance	Main: $T_{CASE} = 70^\circ\text{C}, 95\text{ W DC}, 48\text{ V}$	$R_{\theta JC}$	1.6 °C/W
	Peak: $T_{CASE} = 70^\circ\text{C}, 141\text{ W DC}, 48\text{ V}$	$R_{\theta JC}$	1.1 °C/W

## Ordering Information

Type and Version	Order Code	Package Description	Shipping
GTRA384802FC V1 R0	GTRA384802FC-V1-R0	H-37248C-4, earless flange	Tape & Reel, 50 pcs
GTRA384802FC V1 R2	GTRA384802FC-V1-R2	H-37248C-4, earless flange	Tape & Reel, 250 pcs



**Typical Performance** (data taken in an Wolfspeed production test fixture)

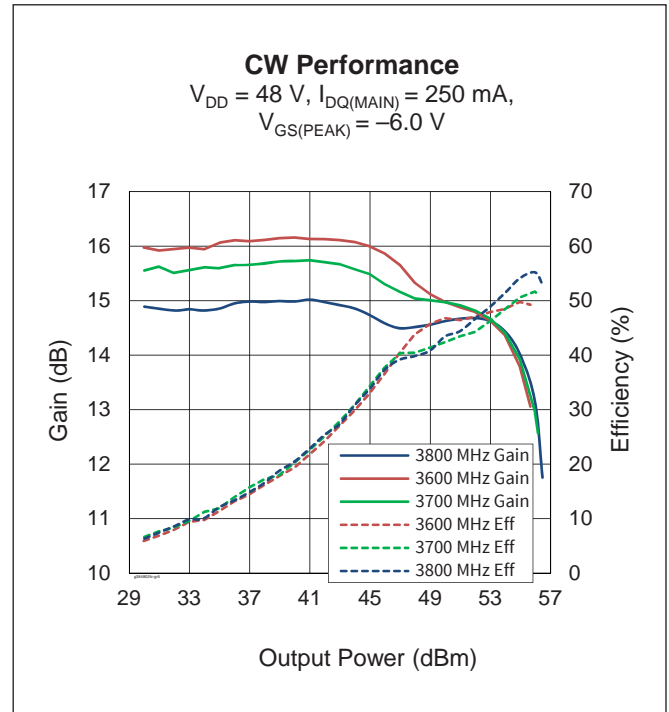
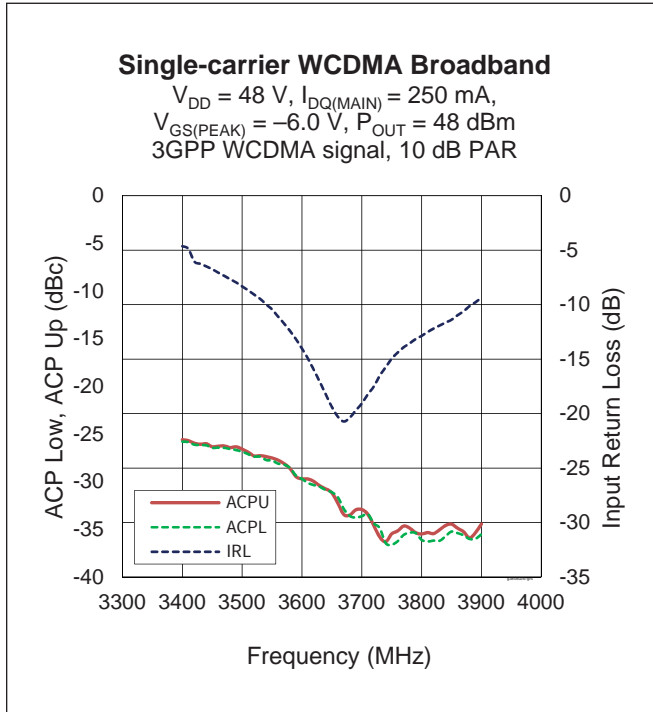
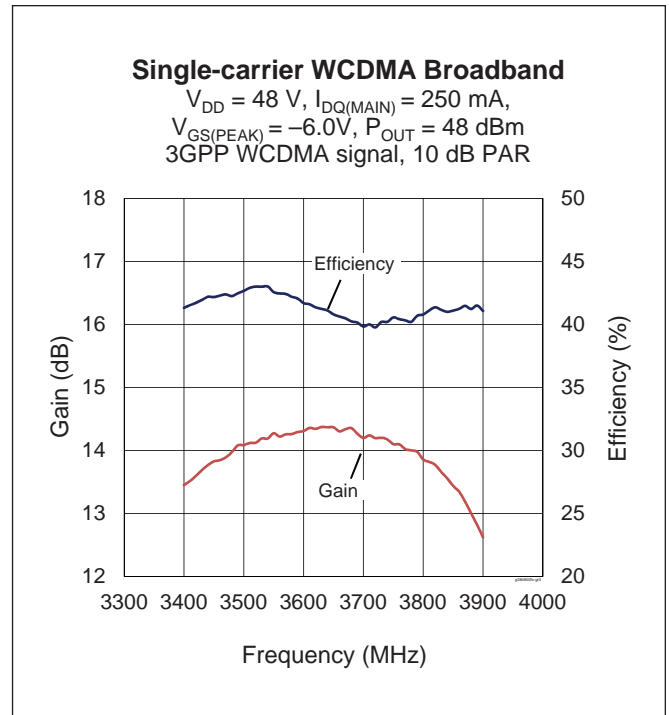
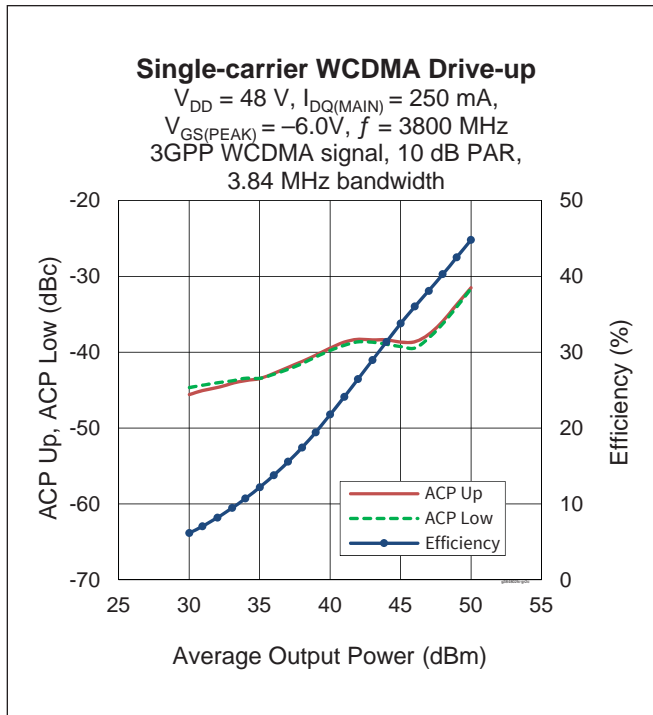

Typical Performance (cont.)

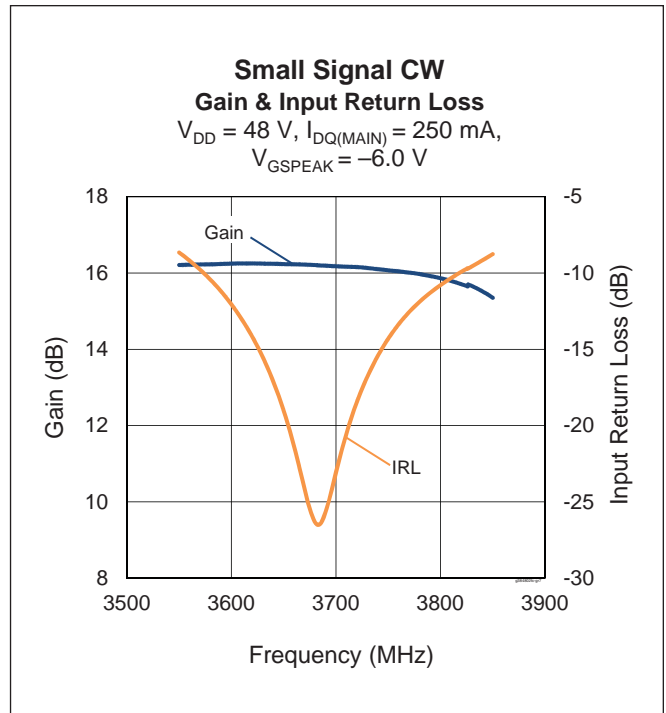
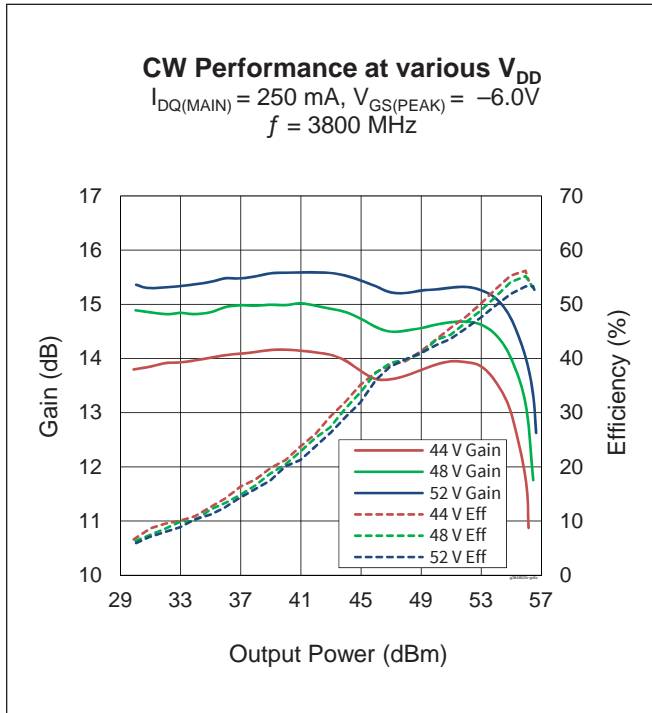

Load Pull

Main side load pull performance – pulsed CW signal: 10  $\mu\text{sec}$ , 10% duty cycle, 48 V,  $I_{DQ} = 250 \text{ mA}$

Class AB		$P_{3dB}$									
		Max Output Power					Max Drain Efficiency				
Freq [MHz]	$Z_{source} [\Omega]$	$Z_{load} [\Omega]$	Gain [dB]	$P_{OUT} [\text{dBm}]$	$P_{OUT} [\text{W}]$	Efficiency [%]	$Z_{load} [\Omega]$	Gain [dB]	$P_{OUT} [\text{dBm}]$	$P_{OUT} [\text{W}]$	Efficiency [%]
3600	11.2 - j7.4	10.2 + j0	18.1	54.70	295	31.3	11.7 - j7	17.0	48.70	74	57.5
3700	6.2 - j5.7	9.5 + j0.9	17.6	54.60	288	31.3	7.5 - j15.6	16.0	48.10	65	57.5
3800	4.0 - j7.3	8.4 + j2	17.4	54.60	288	31.2	16 - j24	14.6	47.20	52	55.5

Peak side load pull performance – pulsed CW signal: 10  $\mu\text{sec}$ , 10% duty cycle, 48 V,  $I_{DQ} = 360 \text{ mA}$

Class AB		$P_{3dB}$									
		Max Output Power					Max Drain Efficiency				
Freq [MHz]	$Z_{source} [\Omega]$	$Z_{load} [\Omega]$	Gain [dB]	$P_{OUT} [\text{dBm}]$	$P_{OUT} [\text{W}]$	Efficiency [%]	$Z_{load} [\Omega]$	Gain [dB]	$P_{OUT} [\text{dBm}]$	$P_{OUT} [\text{W}]$	Efficiency [%]
3600	15 - j11.4	3 - j8.5	15.4	55.90	389	57.5	1.5 - j7.3	18.5	54.60	288	67.0
3700	10.8 - j8.8	3 - j8.8	14.9	55.60	363	52.2	3 - j7.1	15.7	55.00	316	61.3
3800	6.7 - j8	3 - j8.8	15.2	55.60	363	56.9	1.6 - j7.6	17.0	53.50	224	61.8



**Reference Circuit, 3600 – 3800 MHz**

**Reference Circuit Assembly**

DUT	GTRA384802FC V1
Test Fixture Part No.	LTA/GTRA384802FC-V1
PCB	Rogers 4350, LoPro®, 0.526mm [0.0207"] thick, 1 oz. copper, $\epsilon_r = 3.55$
Find Gerber files for this test fixture on the Wolfspeed Web site at <a href="http://www.wolfspeed.com/RF">www.wolfspeed.com/RF</a>	

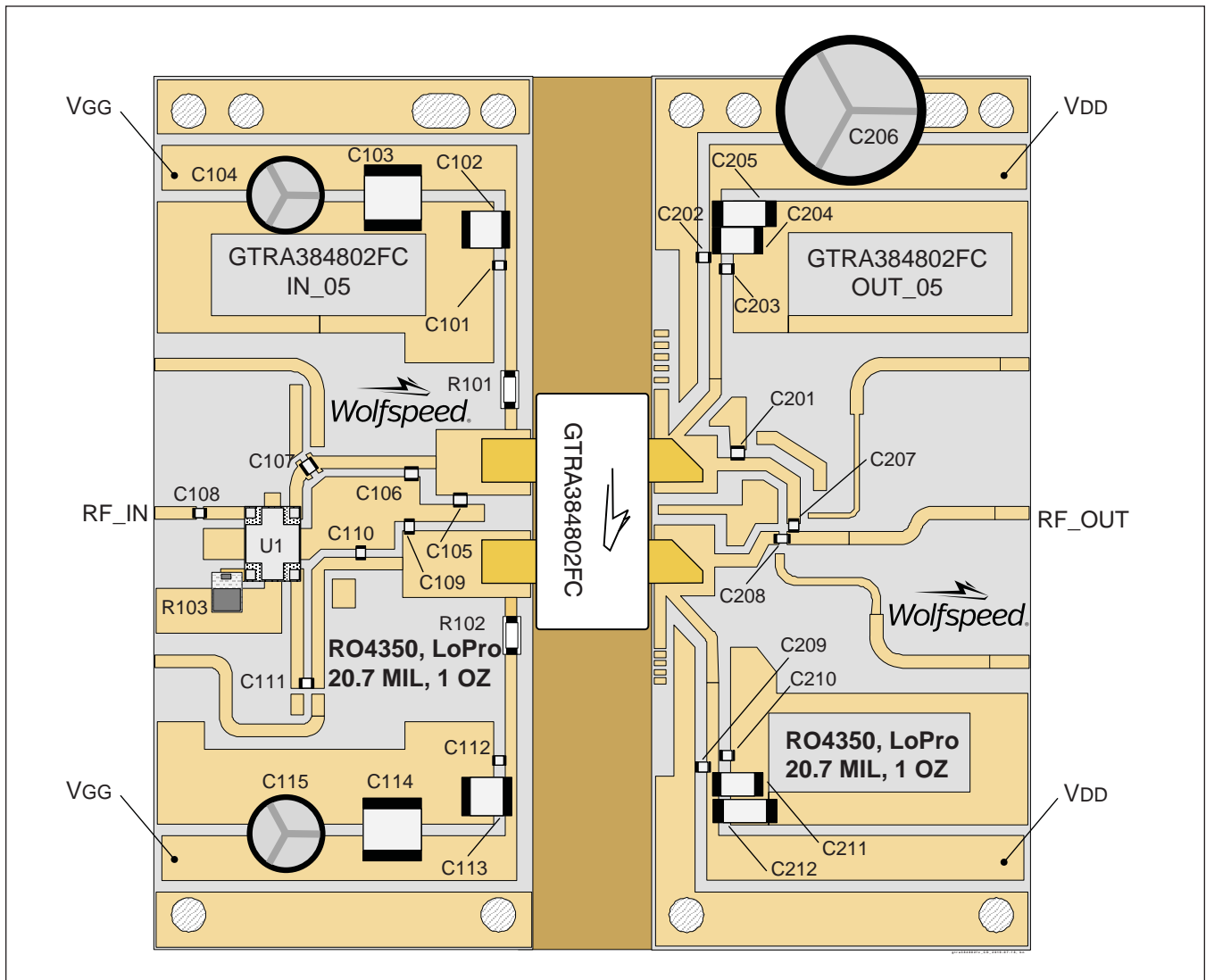

Reference circuit assembly diagram (not to scale)



**Reference Circuit** (cont.)

**Components Information**

Component	Description	Manufacturer	P/N
<b>Input</b>			
C101, C107, C108, C111, C112	Capacitor, 10 pF	ATC	ATC800A100JT250XT
C102, C113	Capacitor, 1 μF	TDK Corporation	C4532X7R2A105M230KA
C103, C114	Capacitor, 10 μF, 100 V	TDK Corporation	C5750X7S2A106M230KB
C104, C115	Capacitor, 100 μF, 35 V	Panasonic Electronic Components	EEE-FT1V101AP
C105, C110	Capacitor, 1.2 pF	ATC	ATC800A1R2CT250XT
C106	Capacitor, 1.7 pF	ATC	ATC800A1R7CT250XT
C109	Capacitor, 0.5 pF	ATC	ATC800A0R5CT250XT
R101, R102	Resistor, 5.6 ohms	Panasonic Electronic Components	ERJ-8RQJ5R6V
R103	Resistor, 50 ohms	Anaren	C8A50Z4A
U1	Hybrid coupler	Anaren	XC3500P-03S
<b>Output</b>			
C201	Capacitor, 0.2 pF	ATC	ATC800A0R2CT250XT
C202, C209	Capacitor, 1000 pF, 100 V	Murata Electronics North America	GRM188R72A102KA01D
C203, C207, C208, C210	Capacitor, 10 pF	ATC	ATC800A100JT250XT
C204, C211	Capacitor, 1 μF	TDK Corporation	C4532X7R2A105M230KA
C205, C212	Capacitor, 10 μF	TDK Corporation	C5750X7S2A106M230KB
C206	Capacitor, 220 μF	Panasonic Electronic Components	ECA-2AHG221

**Pinout Diagram** (top view)

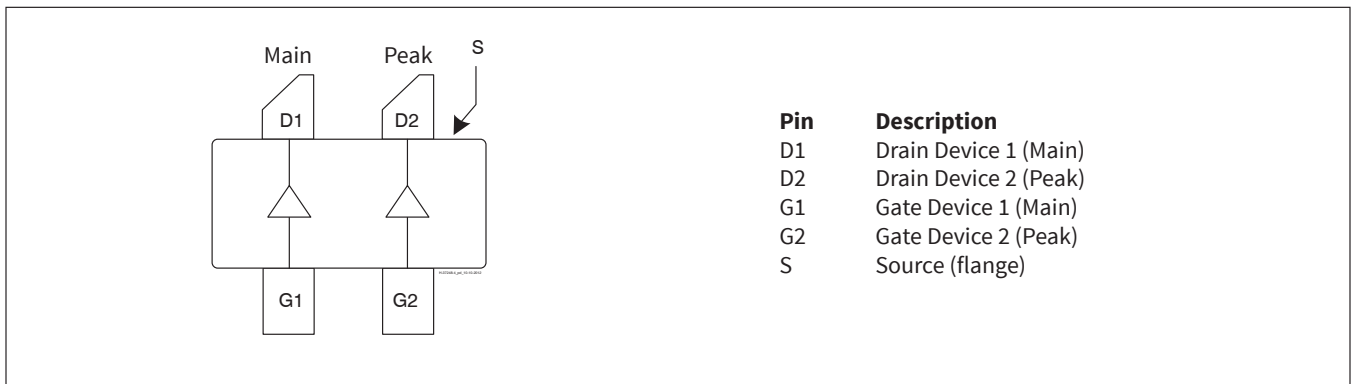

Lead connections for GTRA384802FC

Package Outline Specifications

