

GTVA101K42EV

Thermally-Enhanced High Power RF GaN on SiC HEMT 1400 W, 50 V, DC – 1400 MHz

Description

The GTVA101K42EV is a 1400-watt GaN on SiC high electron mobility transistor (HEMT) for use in the DC to 1400 MHz frequency band. It is a input matched, high efficiency device in a thermally-enhanced package with bolt-down flange.

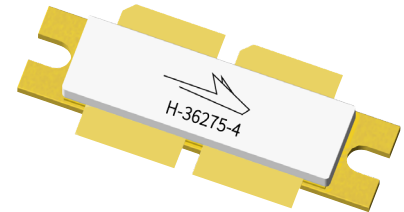

GTVA101K42EV
Package H-36275-4

Features

- GaN on SiC HEMT technology
- Input matched
- Typical Pulsed CW performance, 960 – 1400 MHz, 50 V, single side, 128 μ s pulse width, 10% duty cycle
 - Output power at P_{3dB} = 1400 W
 - Efficiency = 68%
 - Gain = 17 dB
- Pb-free and RoHS compliant

RF Characteristics¹

Pulsed CW Specifications (tested in Wolfspeed test fixture)

V_{DD} = 50 V, I_{DQ} = 75 mA, P_{OUT} (P_{3dB}) = 1400 W peak, f = 1030 MHz, Pulse Width = 128 μ s, Duty Cycle = 10%

Characteristic	Symbol	Min	Typ	Max	Unit
Linear Gain	G_{ps}	17	19	—	dB
Return Loss	R	—	-19	-12	dB
Drain Efficiency	η_D	65	69	—	%
Output Mismatch Stress ²	VSWR	—	—	10:1	Ψ

Note ¹: All published data at T_{CASE} = 25°C unless otherwise indicated.

Note ²: No damage at all phase angles, V_{DD} = 50 V, I_{DQ} = 75mA, P_{OUT} = 1400 W Pulsed.

Note ³: ESD: Electrostatic discharge sensitive device—observe handling precautions!

DC Characteristics

Characteristic	Conditions	Symbol	Min	Typ	Max	Unit
Drain-source Breakdown Voltage	$V_{GS} = -8\text{ V}$, $I_D = 83.6\text{ mA}$	$V_{(BR)DSS}$	125	—	—	V
Drain-source Leakage Current	$V_{GS} = -6\text{ V}$, $V_{DS} = 2\text{ V}$	I_{DSS}	62.7	75.5	—	A
Gate Threshold Voltage	$V_{DS} = 10\text{ V}$, $I_D = 83.6\text{ mA}$	$V_{GS(th)}$	-3.8	-3.0	-2.7	V

Recommended Operating Conditions

Parameter	Conditions	Symbol	Min	Typ	Max	Unit
Drain Operating Voltage		V_{DD}	0	—	50	V
Gate Quiescent Voltage	$V_{DS} = 50\text{ V}$, $I_D = 100\text{ mA}$	$V_{GS(Q)}$	—	-3.1	—	V

Absolute Maximum Ratings

Parameter	Symbol	Value	Unit
Drain-source Voltage	V_{DSS}	150	V
Gate-source Voltage	V_{GS}	-10 to +2	V
Gate Current	I_G	167	mA
Drain Current	I_D	48	A
Junction Temperature	T_J	225	°C
Storage Temperature Range	T_{STG}	-65 to +150	°C

Operation above the maximum values listed here may cause permanent damage. Maximum ratings are absolute ratings; exceeding only one of these values may cause irreversible damage to the component. Exposure to absolute maximum rating conditions for extended periods may affect device reliability. For reliable continuous operation, the device should be operated within the operating voltage range (V_{DD}) specified above.

Thermal Characteristics

Parameter	Symbol	Value	Units
Thermal Resistance, Junction to case ¹	$R_{\theta JC}$.127	°C/W
Thermal Resistance, Junction to case ²	$R_{\theta JC}$.167	°C/W
Thermal Resistance, Junction to case ³	$R_{\theta JC}$.166	°C/W

¹ Tcase = 85°C, P_{DISS} = 700 W, 100 μs Pulse Width, 10% Duty Cycle

² Tcase = 85°C, P_{DISS} = 700 W, 500 μs Pulse Width, 10% Duty Cycle

³ Tcase = 85°C, P_{DISS} = 700 W, Mode-S Signal

Electrical Characteristics When Tested in GTVA101K42EV-AMP2

Characteristics	Symbol	Min.	Typ.	Max.	Units	Conditions
RF Characteristics¹ ($T_C = 25^\circ\text{C}$, $F_0 = 1.2 - 1.4\text{ GHz}$ unless otherwise noted)						
Output Power ²	P_{OUT}	—	61	—	dBm	$V_{DD} = 50\text{ V}$, $I_{DQ} = 1.8\text{ A}$, $P_{IN} = 44\text{ dBm}$
Power Added Efficiency ²	η	—	55	—	%	$V_{DD} = 50\text{ V}$, $I_{DQ} = 1.8\text{ A}$, $P_{IN} = 44\text{ dBm}$
Gain ²	G	—	17	—	dB	$V_{DD} = 50\text{ V}$, $I_{DQ} = 1.8\text{ A}$, $P_{IN} = 44\text{ dBm}$

¹ Measured in the GTVA101K42EV-AMP2 Application Circuit

² Pulsed 500 μs, 10% Duty Cycle



Typical Performance of the GTVA101K42EV-AMP2

Test conditions unless otherwise noted: $V_D = 50\text{ V}$, $I_{DQ} = 1800\text{ mA}$, Pulse Width = $500\text{ }\mu\text{s}$, Duty Cycle = 10%, $P_{in} = 44\text{ dBm}$, $T_{BASE} = +25\text{ }^\circ\text{C}$

Figure 1. Output Power vs Frequency as a Function of Temperature

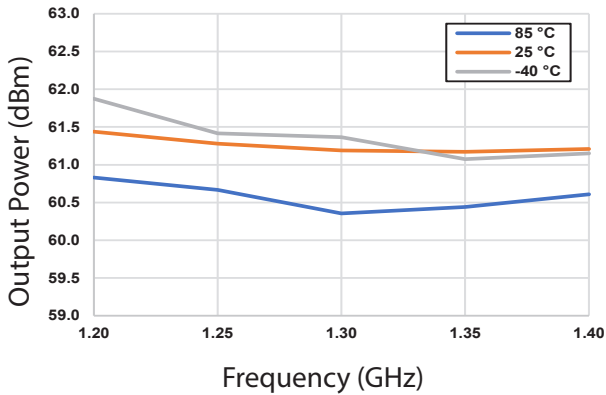

Figure 2. Output Power vs Frequency as a Function of Input Power

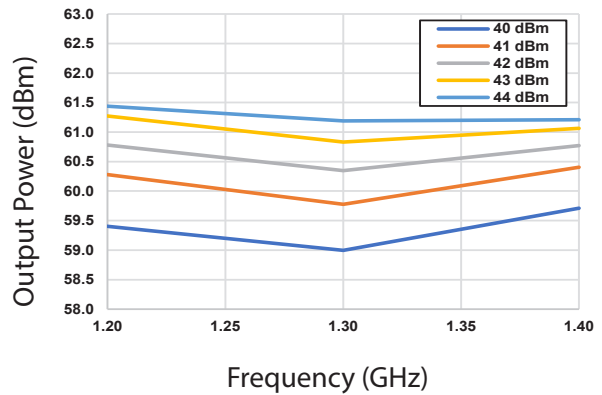

Figure 3. Power Added Eff. vs Frequency as a Function of Temperature

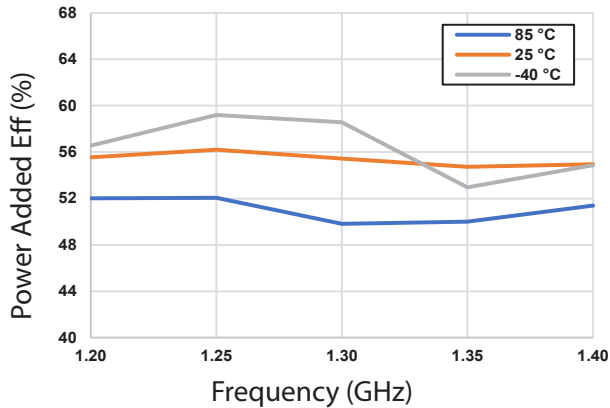

Figure 4. Power Added Eff. vs Frequency as a Function of Input Power

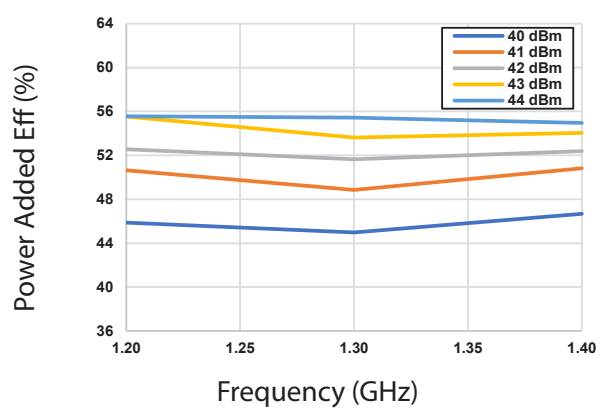

Figure 5. Drain Current vs Frequency as a Function of Temperature

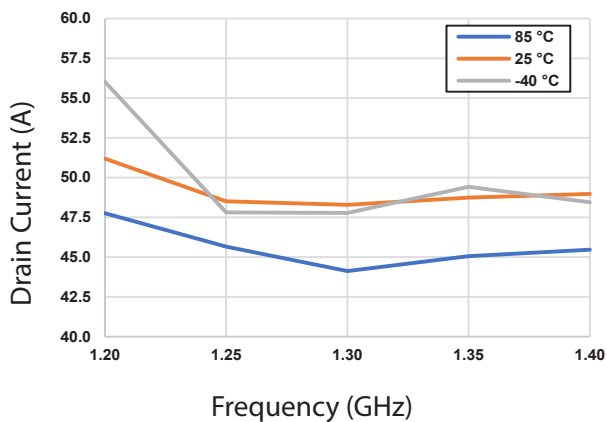
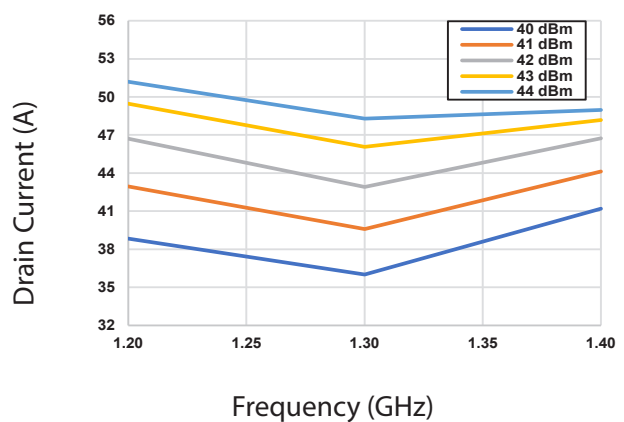

Figure 6. Drain Current vs Frequency as a Function of Input Power





Typical Performance of the GTVA101K42EV-AMP2

Test conditions unless otherwise noted: $V_D = 50\text{ V}$, $I_{DQ} = 1800\text{ mA}$, Pulse Width = $500\text{ }\mu\text{s}$, Duty Cycle = 10%, Pin = 44 dBm, $T_{BASE} = +25\text{ }^\circ\text{C}$

Figure 7. Output Power vs Frequency as a Function of VD

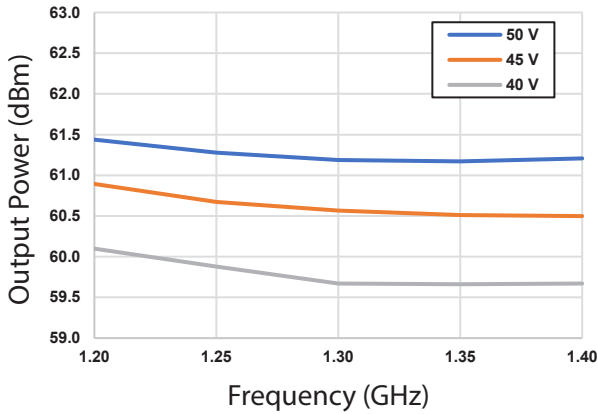

Figure 8. Output Power vs Frequency as a Function of IDQ

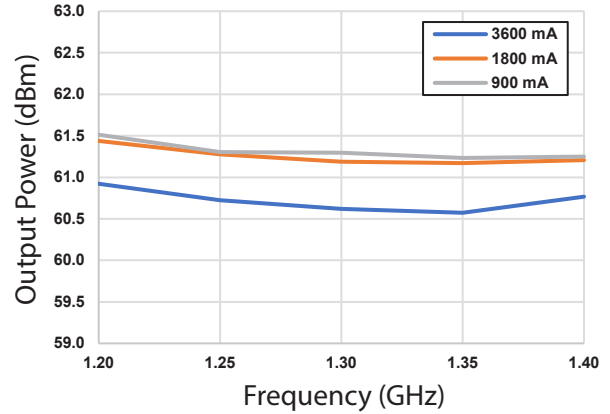

Figure 9. Power Added Eff. vs Frequency as a Function of VD

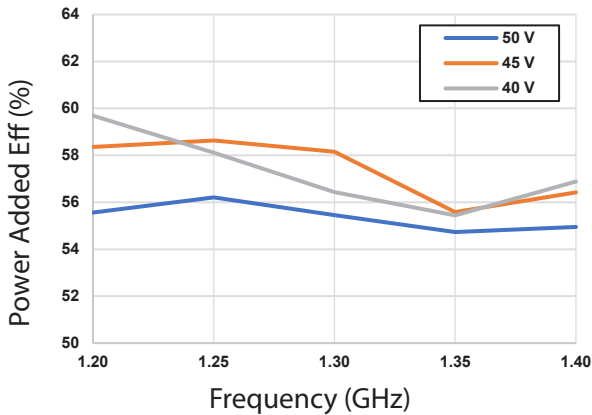

Figure 10. Power Added Eff. vs Frequency as a Function of IDQ

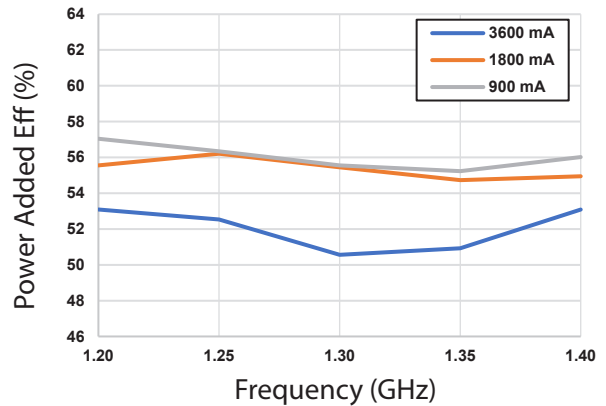

Figure 11. Drain Current vs Frequency as a Function of VD

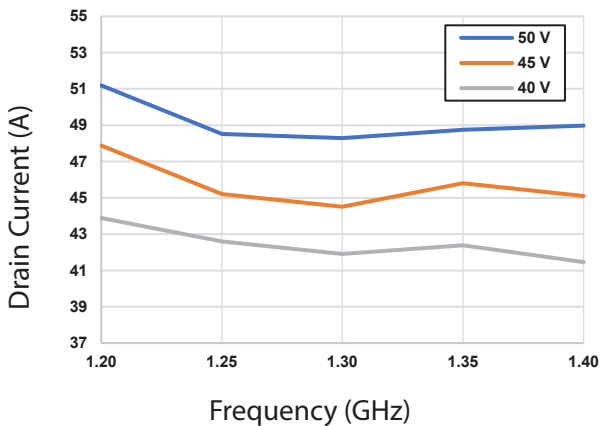
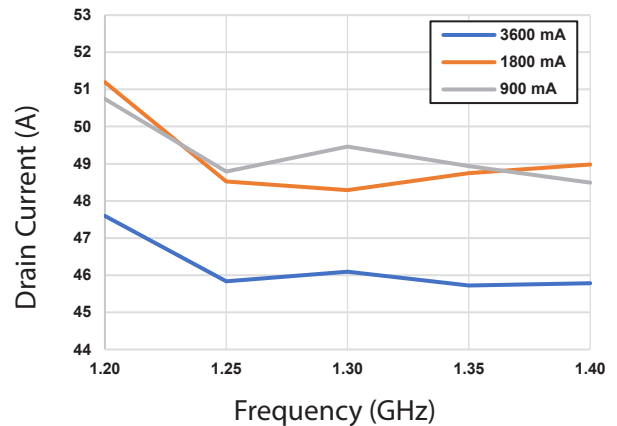

Figure 12. Drain Current vs Frequency as a Function of IDQ





Typical Performance of the GTVA101K42EV-AMP2

Test conditions unless otherwise noted: $V_D = 50\text{ V}$, $I_{DQ} = 1800\text{ mA}$, Pulse Width = $500\text{ }\mu\text{s}$, Duty Cycle = 10%, $P_{in} = 44\text{ dBm}$, $T_{BASE} = +25\text{ }^\circ\text{C}$

Figure 13. Output Power vs Input Power as a Function of Frequency

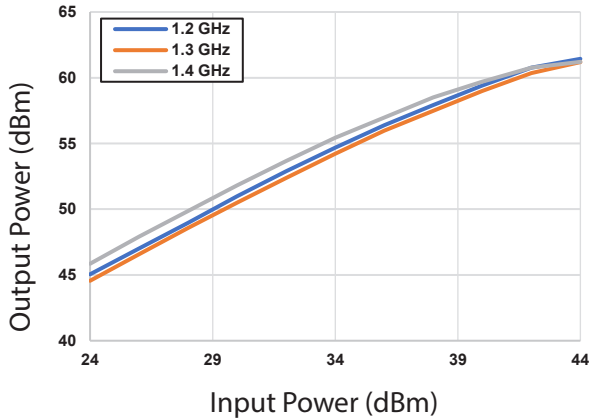

Figure 14. Power Added Eff. vs Input Power as a Function of Frequency

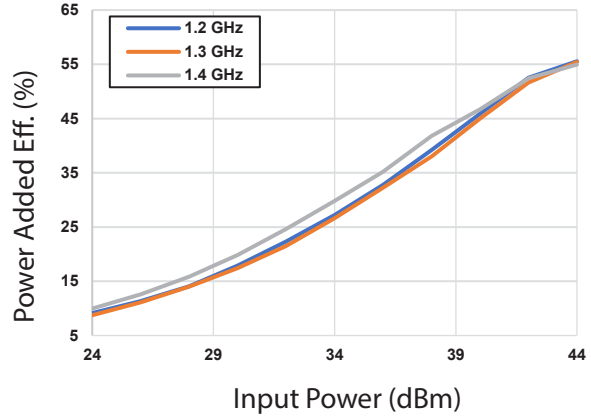

Figure 15. Large Signal Gain vs Input Power as a Function of Frequency

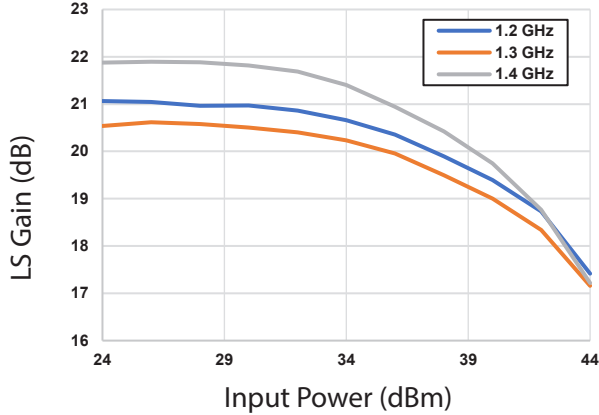

Figure 16. Drain Current vs Input Power as a Function of Frequency

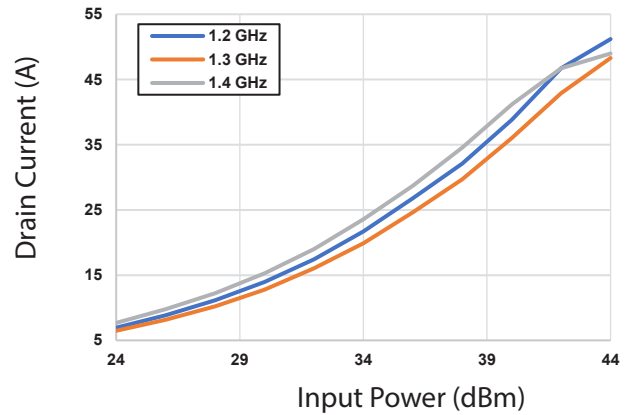

Figure 17. Gate Current vs Input Power as a Function of Frequency

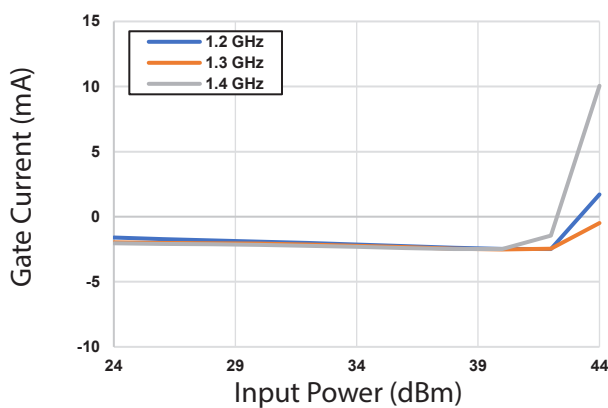
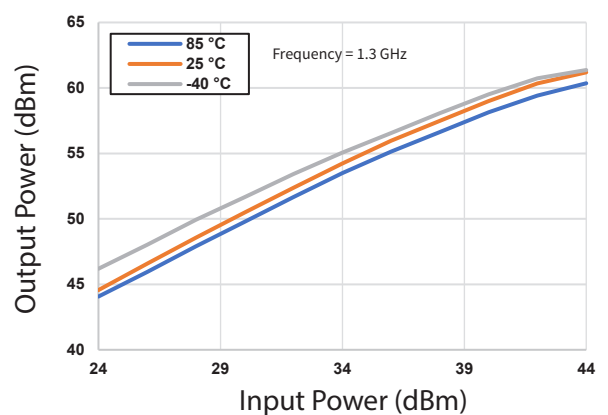

Figure 18. Output Power vs Input Power as a Function of Temperature



Typical Performance of the GTVA101K42EV-AMP2

Test conditions unless otherwise noted: $V_D = 50\text{ V}$, $I_{DQ} = 1800\text{ mA}$, Pulse Width = $500\text{ }\mu\text{s}$, Duty Cycle = 10%, $P_{in} = 44\text{ dBm}$, $T_{BASE} = +25\text{ }^\circ\text{C}$

Figure 19. Power Added Eff. vs Input Power as a Function of Temperature

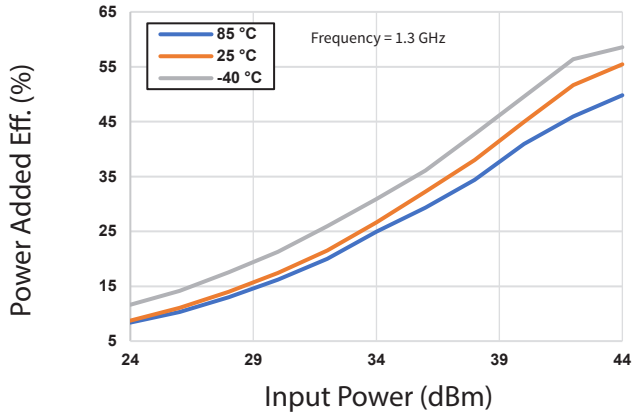

Figure 20. Large Signal Gain vs Input Power as a Function of Temperature

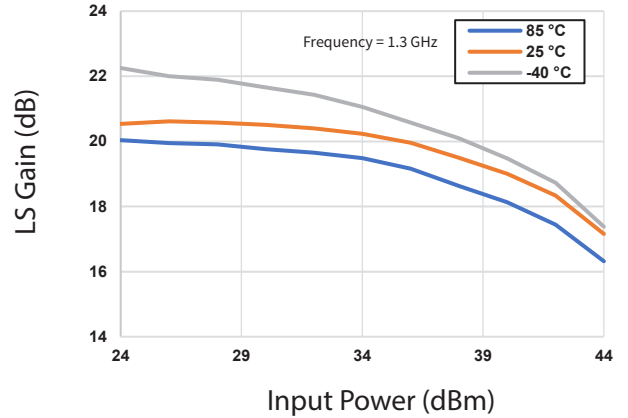

Figure 21. Drain Current vs Input Power as a Function of Temperature

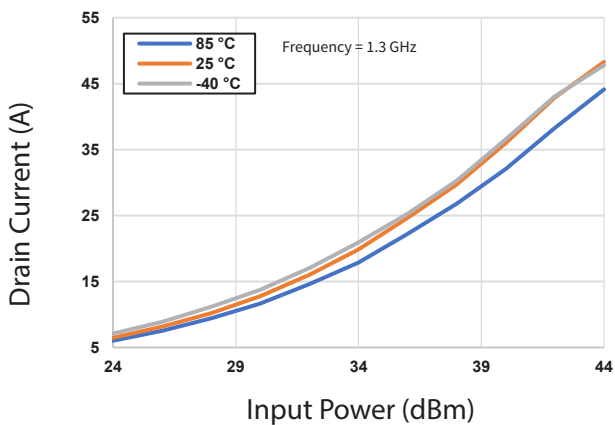

Figure 22. Gate Current vs Input Power as a Function of Temperature

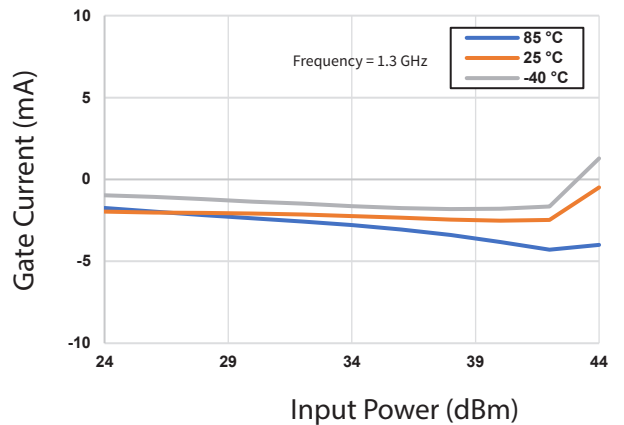

Figure 23. Output Power vs Input Power as a Function of IDQ

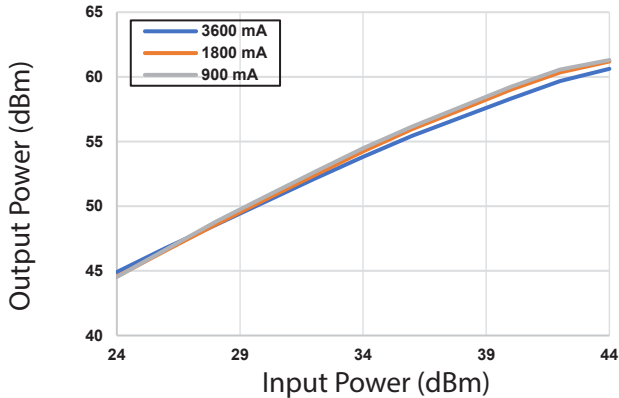
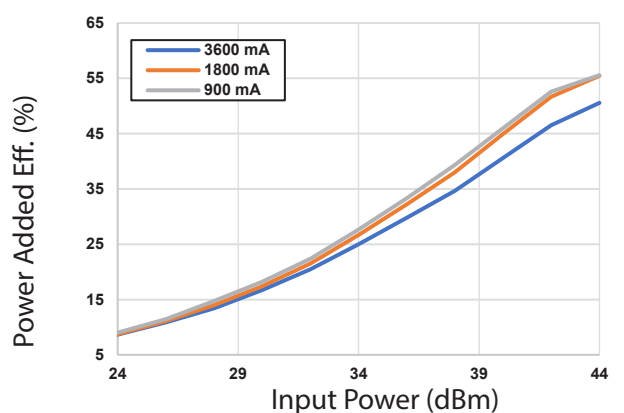

Figure 24. Power Added Eff. vs Input Power as a Function of IDQ





Typical Performance of the GTVA101K42EV-AMP2

Test conditions unless otherwise noted: $V_D = 50\text{ V}$, $I_{DQ} = 1800\text{ mA}$, Pulse Width = $500\text{ }\mu\text{s}$, Duty Cycle = 10%, Pin = 44 dBm, $T_{BASE} = +25\text{ }^\circ\text{C}$

Figure 25. 2nd Harmonic vs Frequency as a Function of Temperature

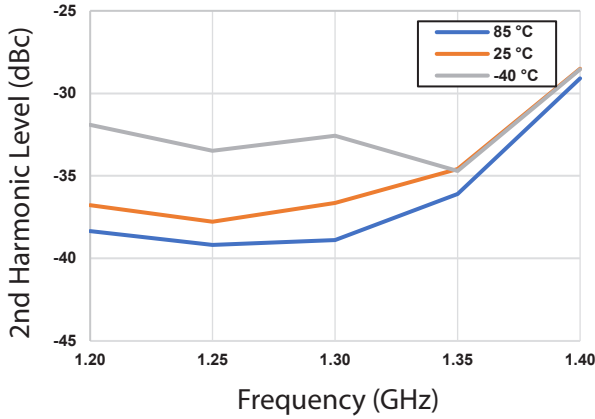

Figure 26. 3rd Harmonic vs Frequency as a Function of Temperature

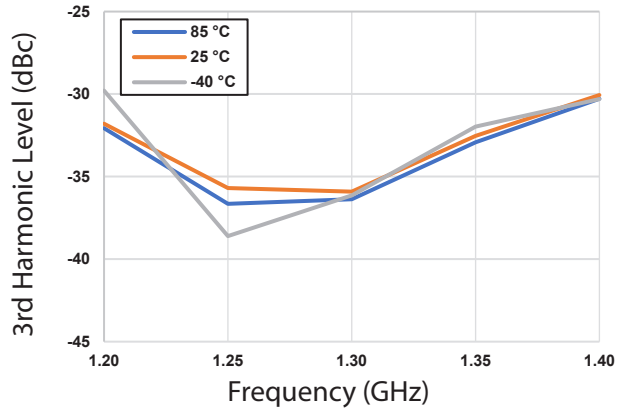

Figure 27. 2nd Harmonic vs Output Power as a Function of Frequency

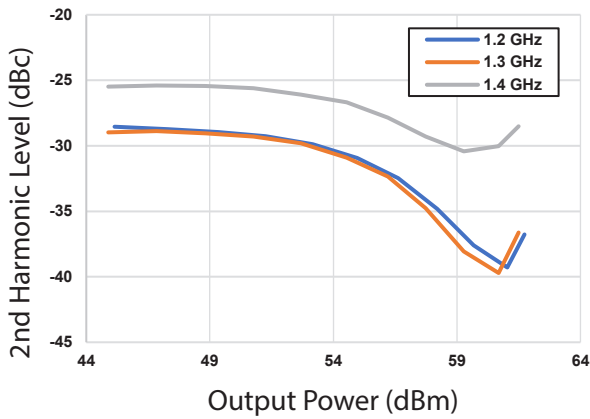

Figure 28. 3rd Harmonic vs Output Power as a Function of Frequency

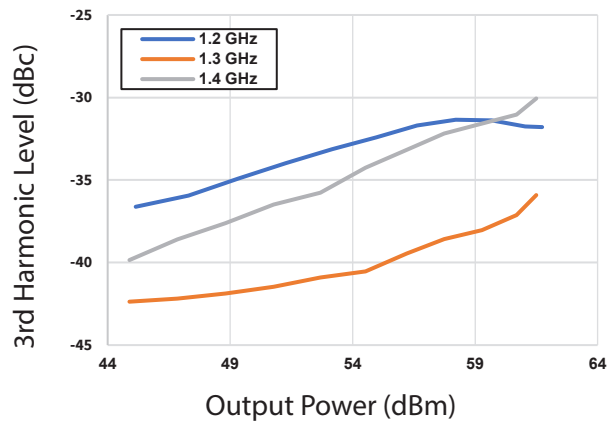

Figure 29. 2nd Harmonic vs Output Power as a Function of IDQ

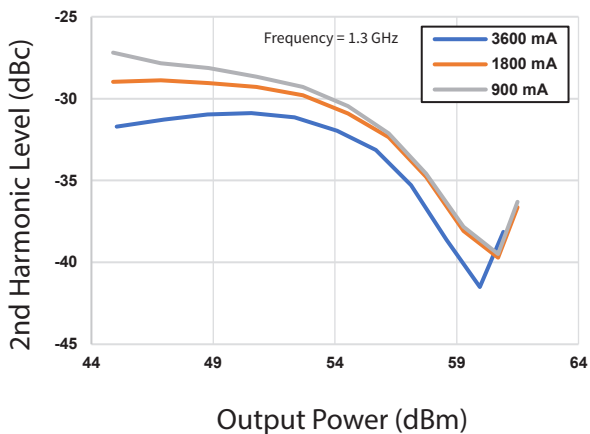
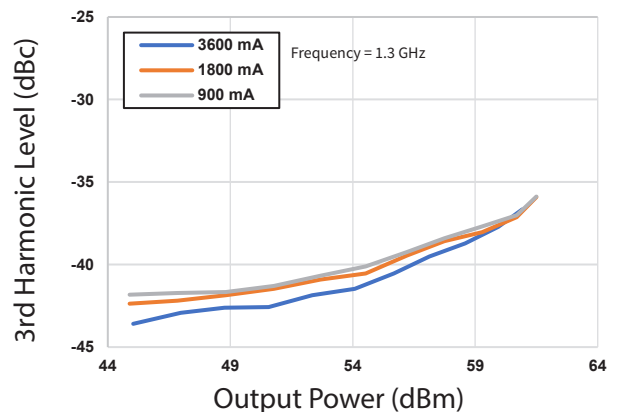

Figure 30. 3rd Harmonic vs Output Power as a Function of IDQ





Typical Performance of the GTVA101K42EV-AMP2

Test conditions unless otherwise noted: $V_D = 50\text{ V}$, $I_{DQ} = 1800\text{ mA}$, $P_{in} = -20\text{ dBm}$, $T_{BASE} = +25\text{ }^\circ\text{C}$

Figure 31. Gain vs Frequency as a Function of Temperature

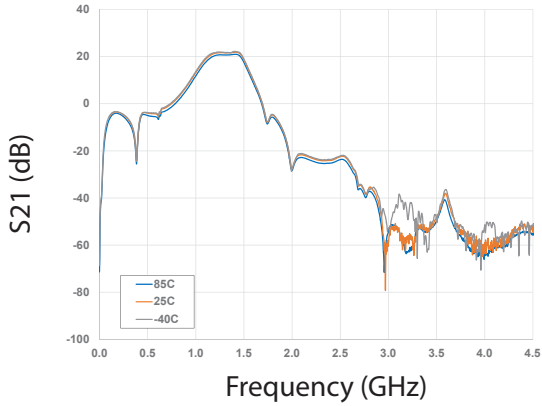

Figure 32. Gain vs Frequency as a Function of Temperature

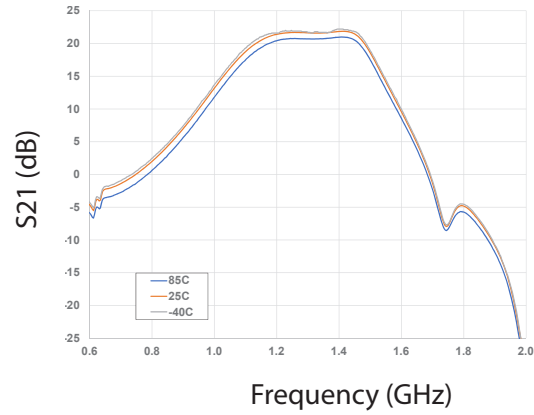

Figure 33. Input RL vs Frequency as a Function of Temperature

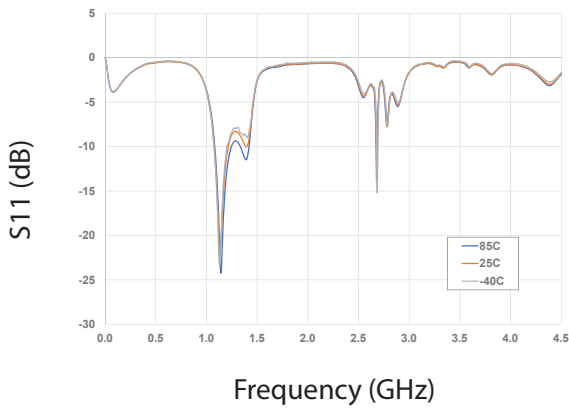

Figure 34. Input RL vs Frequency as a Function of Temperature

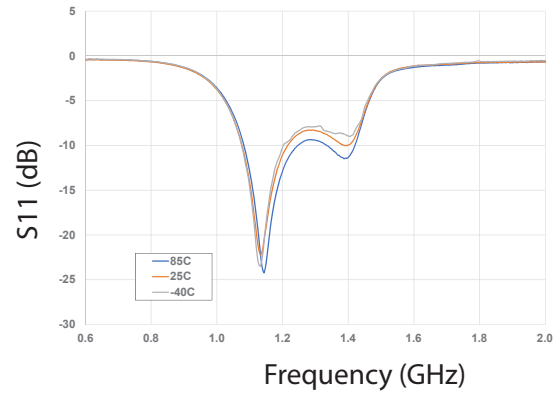

Figure 35. Output RL vs Frequency as a Function of Temperature

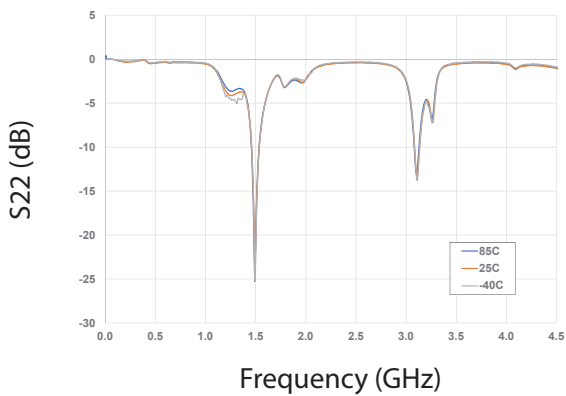
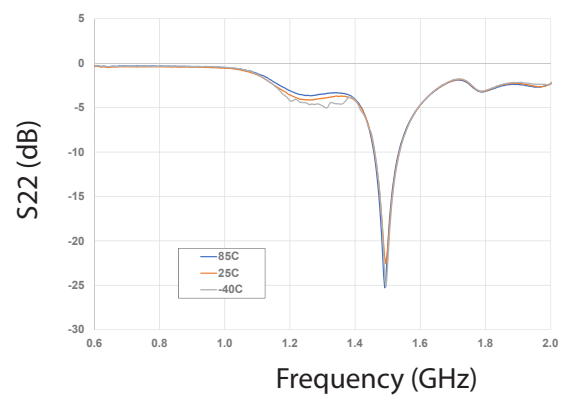

Figure 36. Output RL vs Frequency as a Function of Temperature





Typical Performance of the GTVA101K42EV-AMP2

Test conditions unless otherwise noted: $V_D = 50\text{ V}$, $I_{DQ} = 1800\text{ mA}$, $P_{in} = -20\text{ dBm}$, $T_{BASE} = +25\text{ }^\circ\text{C}$

Figure 37. Gain vs Frequency as a Function of Voltage

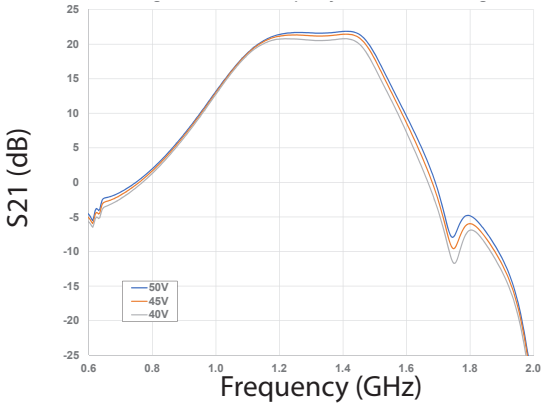

Figure 38. Gain vs Frequency as a Function of IDQ

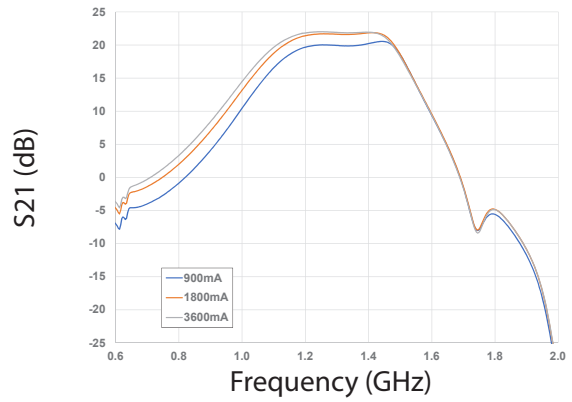

Figure 39. Input RL vs Frequency as a Function Voltage

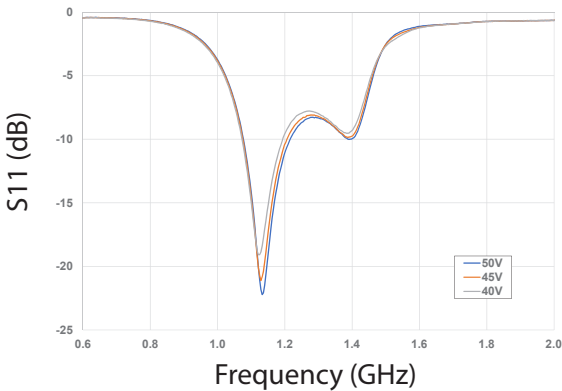

Figure 40. Input RL vs Frequency as a Function of IDQ

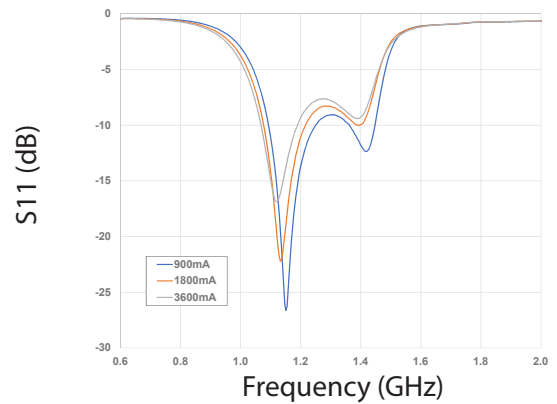

Figure 41. Output RL vs Frequency as a Function of Voltage

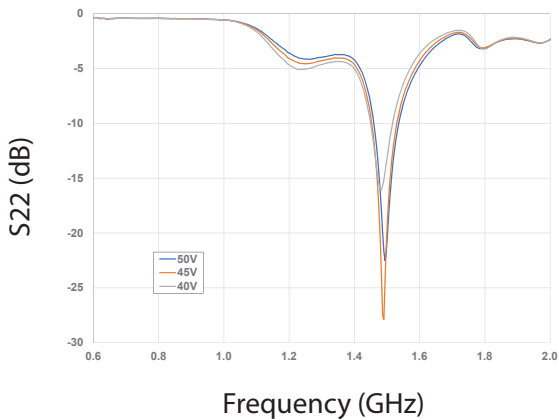
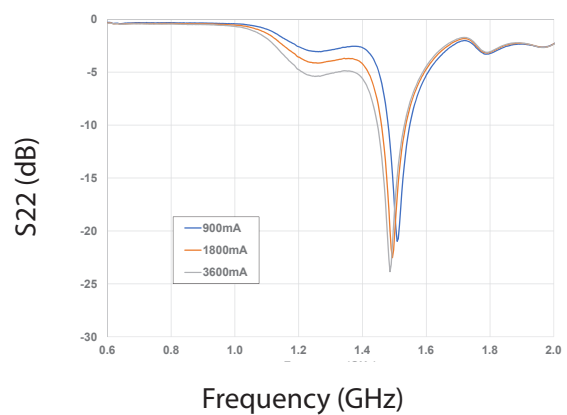
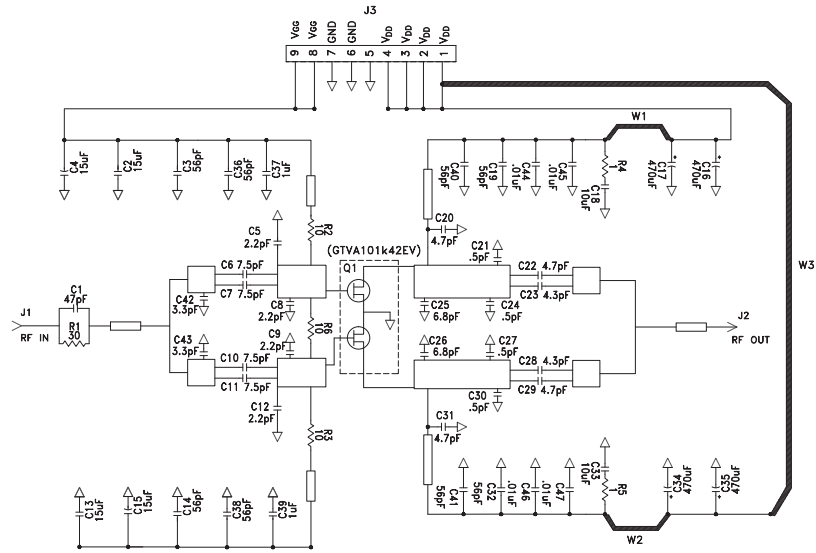

Figure 42. Output RL vs Frequency as a Function of Voltage



GTVA101K42EV-AMP2 Application Circuit Schematic



GTVA101K42EV-AMP2 Application Circuit

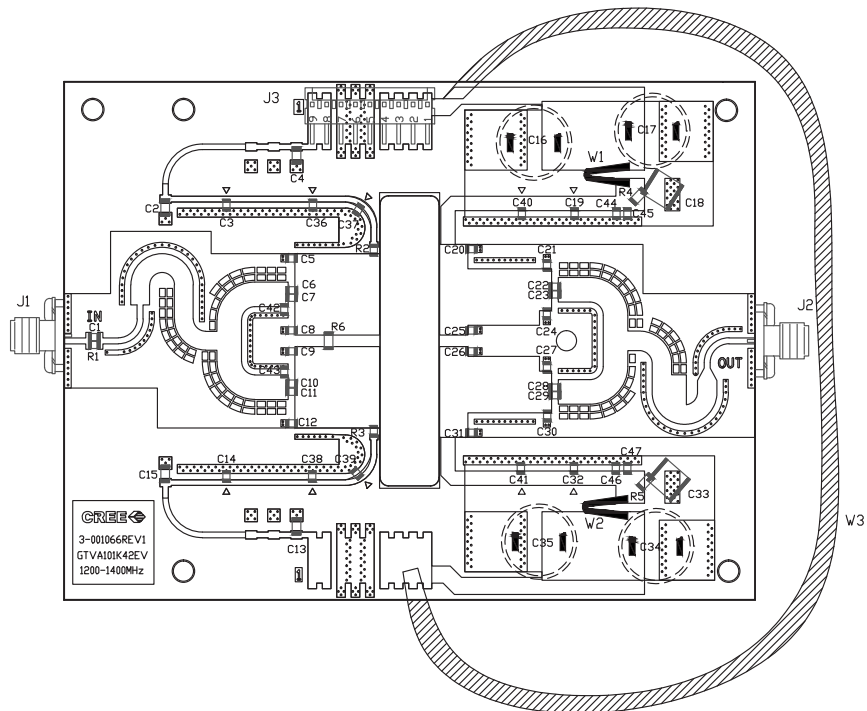

GTVA101K42EV-AMP2 Application Circuit Bill of Materials

Designator	Description	Qty
R1	RES, 30 OHMS, +/- 1%, 0805, 1/8W, YAGEO	1
R2, R3	RES, 10 OHMS, +/- 1%, 0805, 1/8W, YAGEO	2
R4, R5	RES, 1 OHMS, +/- 5%, 1206, 125mW, AVX	2
R6	RES, 10 OHMS, +/-1%, 1206, 1/4W	1
C1	CAP, 47pF, +/- 5%, 250V, 0805, ATC 600F	1
C2,C4, C13, C15	CAP, 15uF, +/-20%, 10V, X7s, 1206, TDK	4
C3, C14, C19, C32, C36, C38, C40, C41	CAP, 56pF, +/- 5%, 250V, 0805, ATC, 600F	8
C5, C8, C9, C12	CAP, 2.2pF, +/- .1pF, 250V, 0805, ATC 600F	4
C6, C7, C10, C11	CAP, 7.5pF, +/- .25pF, 250V, 0805, ATC 600F	4
C16, C17, C34, C35	CAP, 470uF, +/-20%, 80V, Electrolytic, Vishay	4
C18, C33	CAP, 10uF, +/- 10%, 100V, X7S, 2220, TDK	2
C20, C22, C29, C31	CAP, 4.7pF, +/- .25pF, 250V, 0805, ATC 600F	4
C21, C24, C27, C30	CAP, .5pF, +/- .05pF, 250V, 0805, ATC 600F	4
C23, C28	CAP, 4.3pF, +/- .25pF, 250V, 0805, ATC 600F	2
C25, C26	CAP, 6.8pF, +/- .25pF, 250V, 0805, ATC 600F	2
C37, C39	CAP, 1uF, 100V, X7S, 0805, Murata	2
C44, C45, C46, C47	CAP, .01uF, 50V, X7R	4
C42, C43	CAP, 3.3pF, +/- .1pF, 250V, 0805, ATC 600F	2
W1, W2	Wire, 3.25", 18AWG	2
W3	Wire, 7", 12AWG	1
Q1	Transistor, GTVA101K42EV	1



Pinout Diagram (top view)

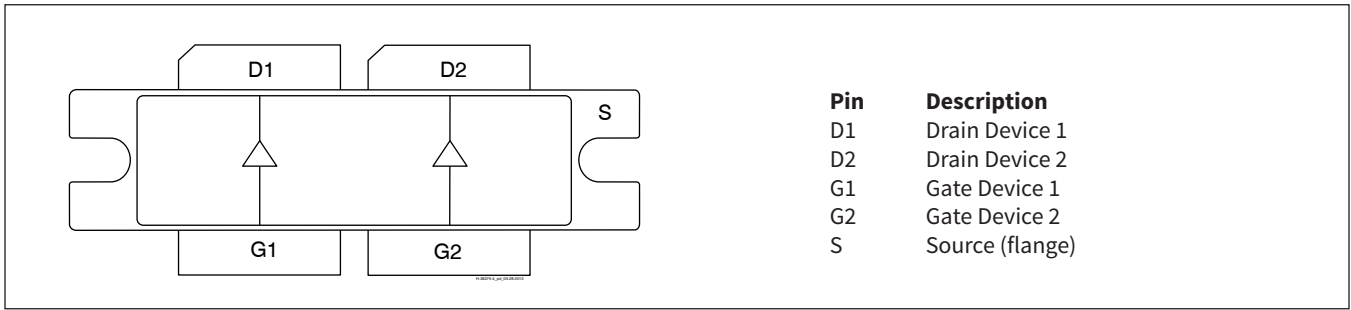

Package Outline Specifications

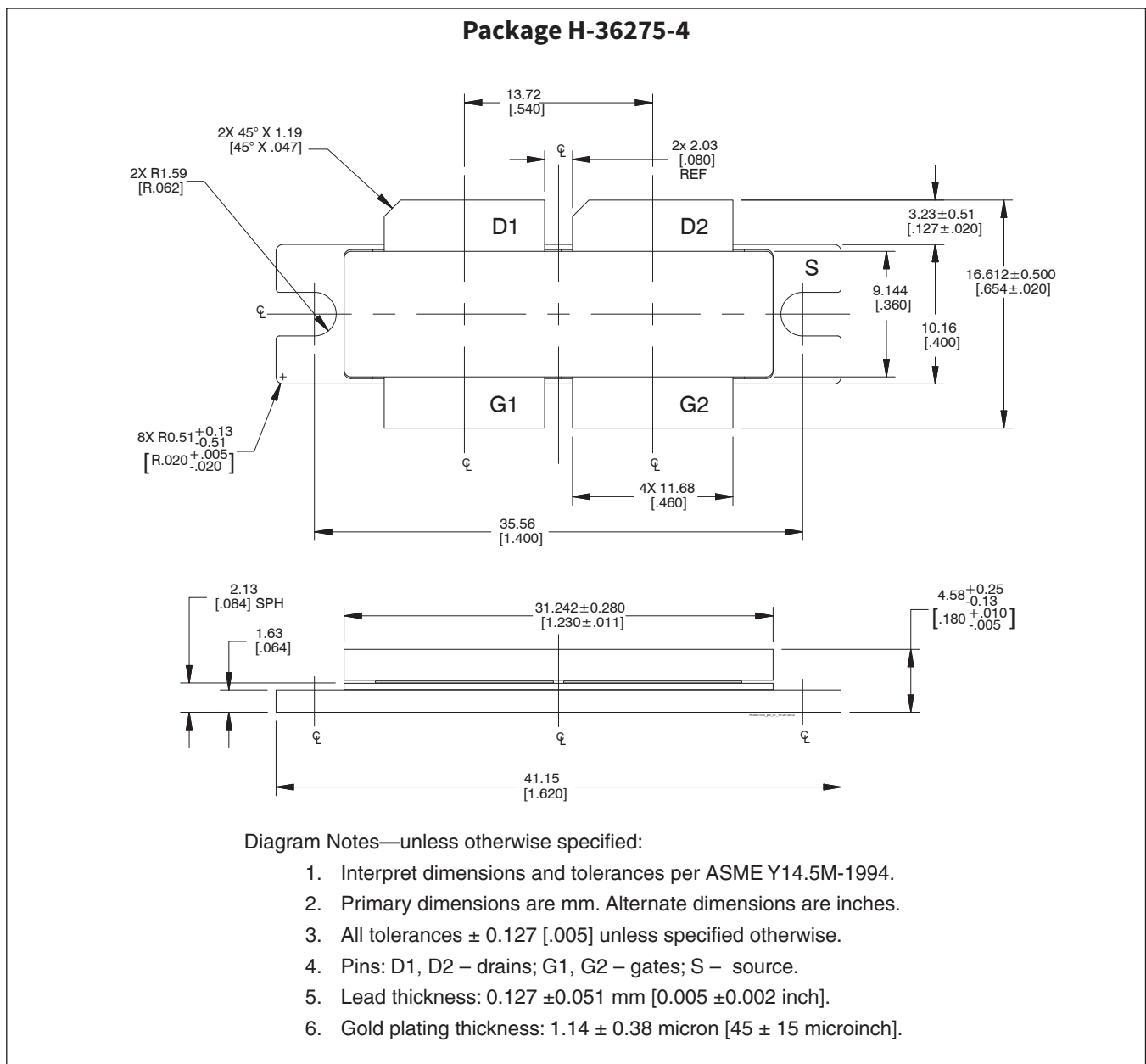



Product Ordering Information

Order Number	Description	Unit of Measure	Image
GTVA101K42EV-V1-R0	GaN HEMT, Tape & Reel, 50 pcs	Each	
GTVA101K42EV-V1-R2	GaN HEMT, Tape & Reel, 250 pcs	Each	
LTN/GTVA101K42EV V1	Test Board with GaN HEMT installed IFF, 1030 MHz	Each	
GTVA101K42EV-AMP2	Test board with GaN HEMT installed L-Band Radar, 1.2 - 1.4 GHz	Each	