



TAOGLAS®



Datasheet

GW.59 3dBi Wi-Fi 6 Dipole Antenna

Part No: GW.59.3153

Description:

3dBi Wi-Fi 6 Dipole Antenna, Hinged RP-SMA(M)

Features:

Wi-Fi 2.4/5.8/7.1GHz

Covers Wi-Fi 6 Frequencies: 5.9-71GHz

RP-SMA Male Straight Connector

Hinged Connector

TPU Housing

Dimensions: 156 * Ø13 mm

RoHS & REACH Compliant

1. Introduction	3
2. Specifications	4
3. Antenna Characteristics	5
4. Radiation Patterns	8
5. Mechanical Drawing	12
6. Packaging	13
7. Application Note	14
<hr/>	
Changelog	18

Taoglas makes no warranties based on the accuracy or completeness of the contents of this document and reserves the right to make changes to specifications and product descriptions at any time without notice. Taoglas reserves all rights to this document and the information contained herein. Reproduction, use or disclosure to third parties without express permission is strictly prohibited.



1. Introduction



The Taoglas GW.59 is an RP-SMA terminal mount dipole antenna, ideal for Wi-Fi wireless applications such as Bluetooth and Wireless LAN. With the capacity to cover Wi-Fi 6 frequencies up to 7.125GHz, the GW.59 is the ideal future proof antenna for the use of Wi-Fi 6 – Extended Wi-Fi. It has an omnidirectional radiation pattern and 3dBi gain across all bands which ensures constant reception and transmission in the system. At 156mm in length, the antenna structure is designed for robust usage and the ruggedized, quality enclosure is made from TPU, giving superior environmental reliability. The antenna can be rotated 90 degrees on the base hinge for ease of positioning.

Many module manufacturers specify peak gain requirements for any antennas that is to be connected to that module. Upon testing of any of our antennas with your device and a selection of appropriate layout, integration technique, or cable, Taoglas can make sure any of our antennas peak gain will be below the peak gain requirements. Taoglas can then issue a specification and/or report for these selected Wi-Fi antennas in your device that will clearly show it complying with the peak gain requirements, so you can be assured you are meeting regulatory requirements for that module. It is better not to select an embedded antenna with very low free-space peak gain (<2dBi) directly, as this antenna would have worse performance in your device, and lead to compromised performance compared to using a Taoglas antenna. For more information, contact your regional sales office.

The connector can be customized subject to MOQ, please contact your regional Taoglas customer support team for further information.

2. Specifications

Wi-Fi Electrical

Band		Frequency (MHz)	Efficiency (%)	Average Gain (dB)	Peak Gain (dBi)	Impedance	Max Power Input	Polarization	Radiation Pattern
2.4GHz Wi-Fi	Straight	2400~2500	79	-1.0	3.8	50Ω	1W	Linear	Omnidirectional
	90°Bent	2400~2500	85	-0.7	2.3				
5.8GHz Wi-Fi	Straight	5150~5850	72	-1.4	5.3				
	90°Bent	5150~5850	72	-1.4	3.7				
7.1GHz Wi-Fi 6	Straight	5925~7125	80	-1.0	4.6				
	90°Bent	5925~7125	76	-1.2	5.6				

Mechanical

Antenna Cover	TPE
Antenna Base	PC & PBT
Colour	Black
Connector	RP-SMA(M)

Environmental

Operation Temperature	-40°C to 85°C
Storage Temperature	-40°C to 85°C

3. Antenna Characteristics

3.1 Return Loss

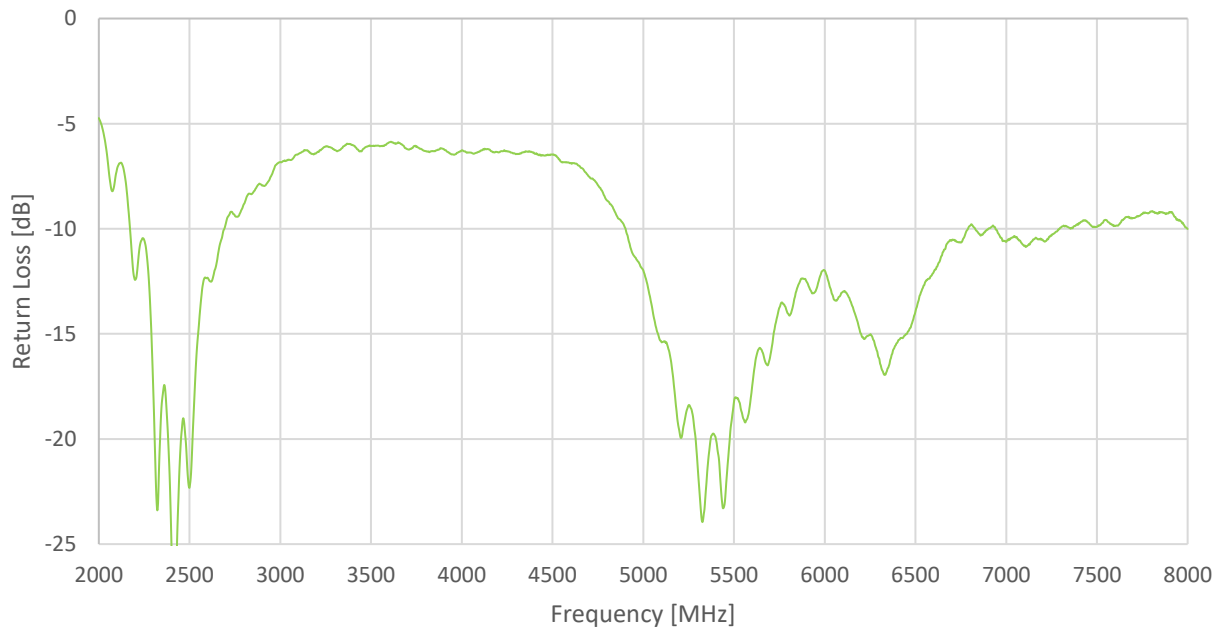

3.2 VSWR

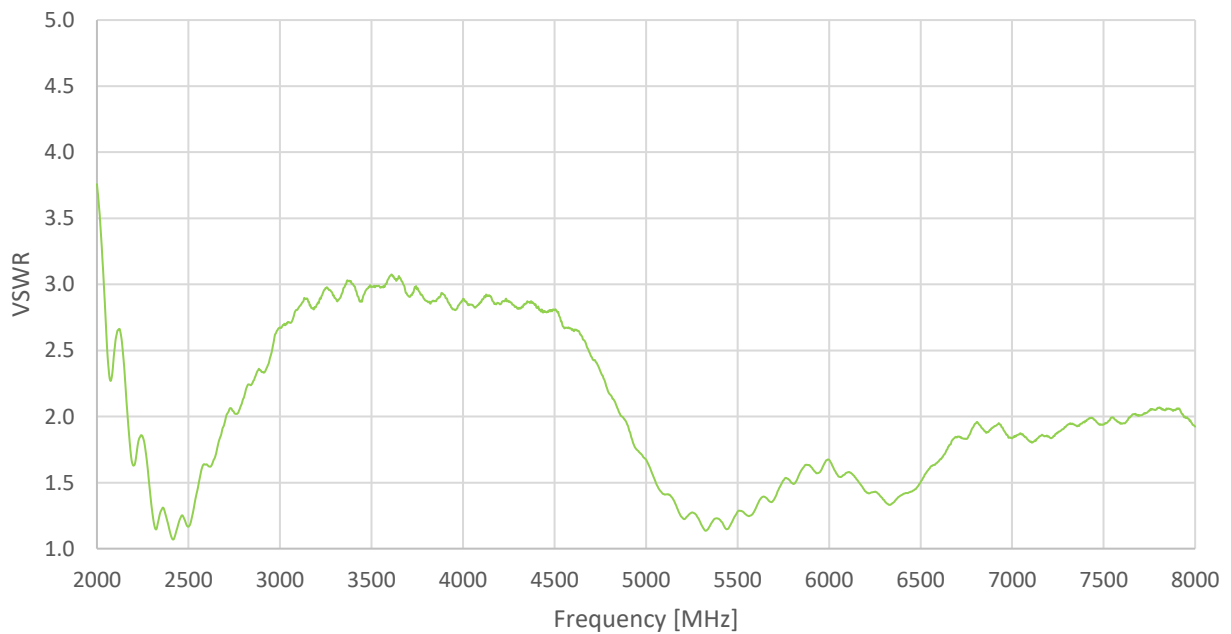

3.3 Efficiency

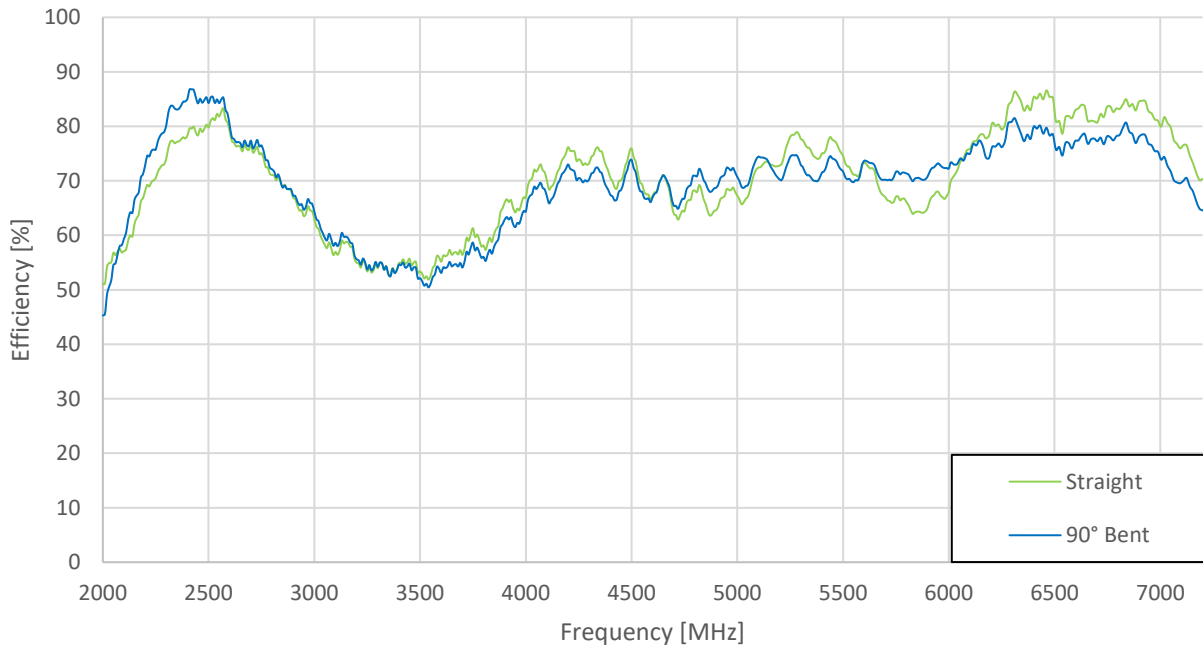

3.4 Peak Gain

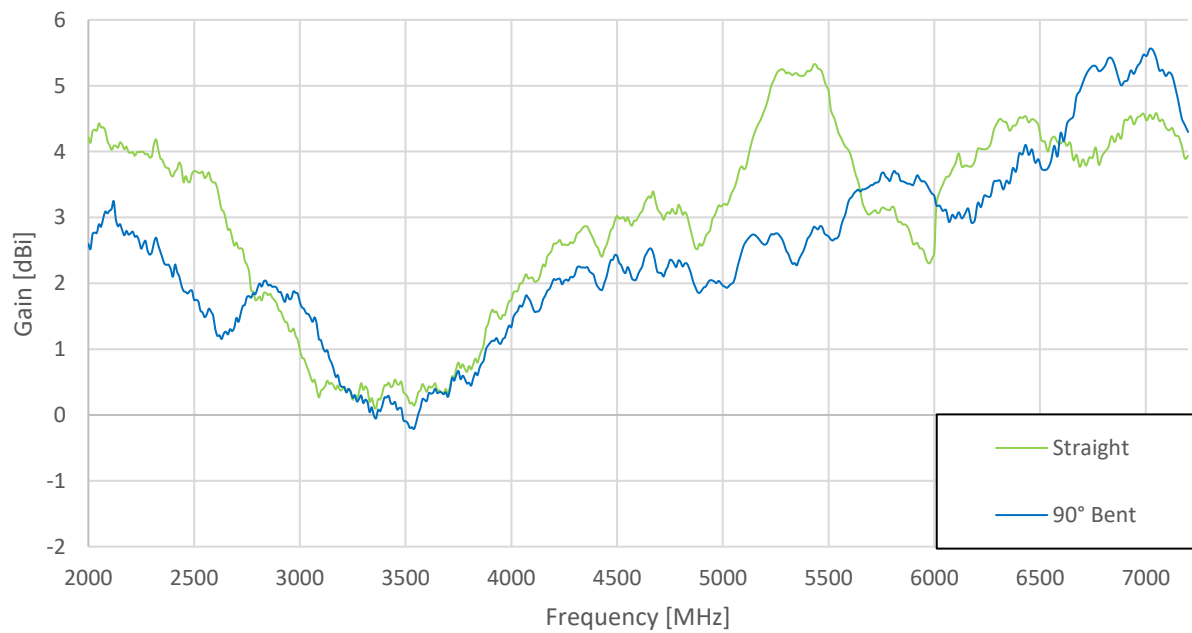

3.5 Average Gain

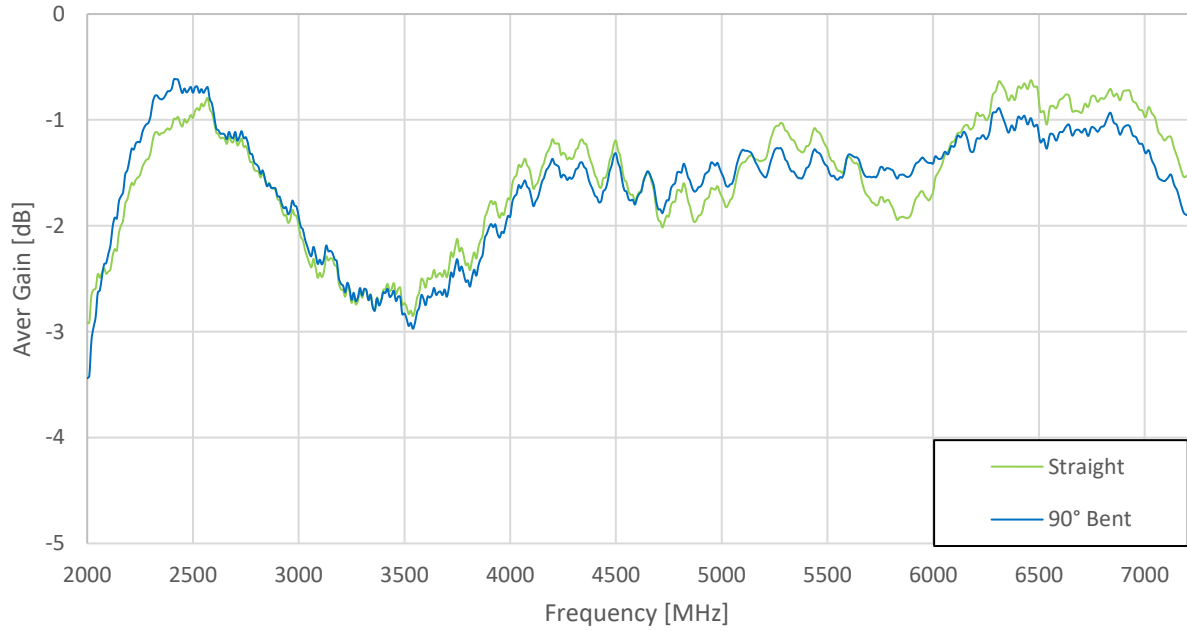

4. Radiation Patterns

4.1 Test Setup

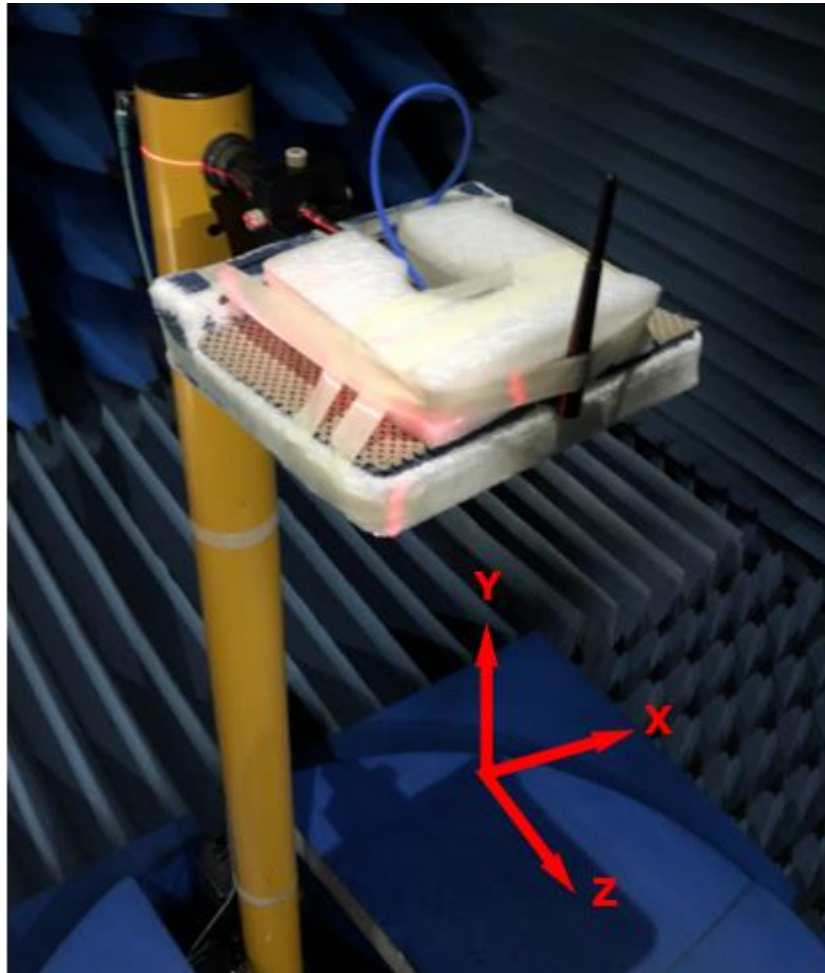

Chamber Set-Up

4.2 2450MHz 3D and 2D Radiation Patterns

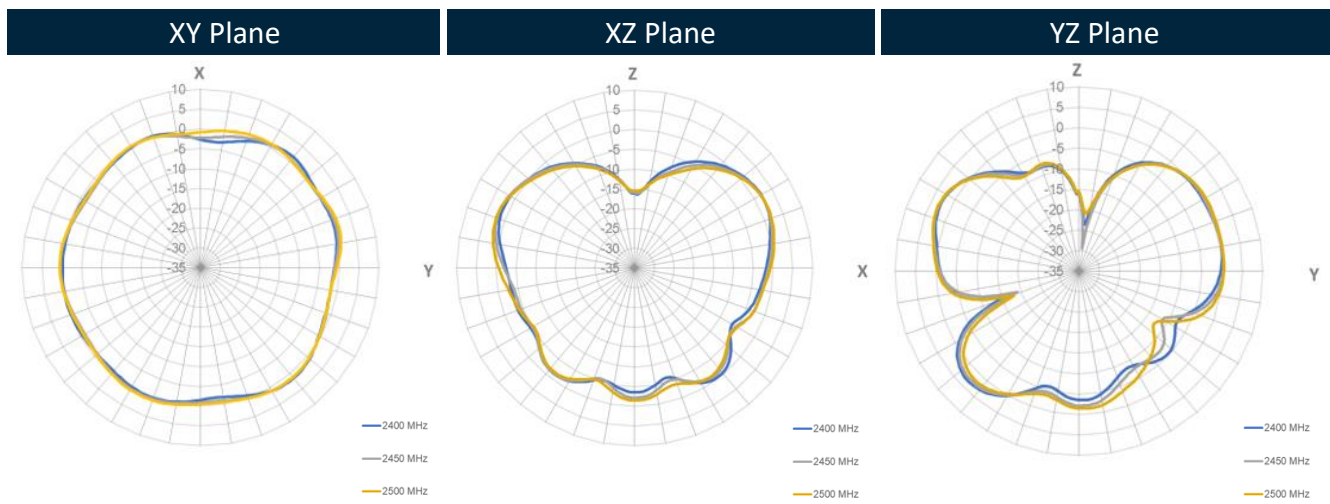
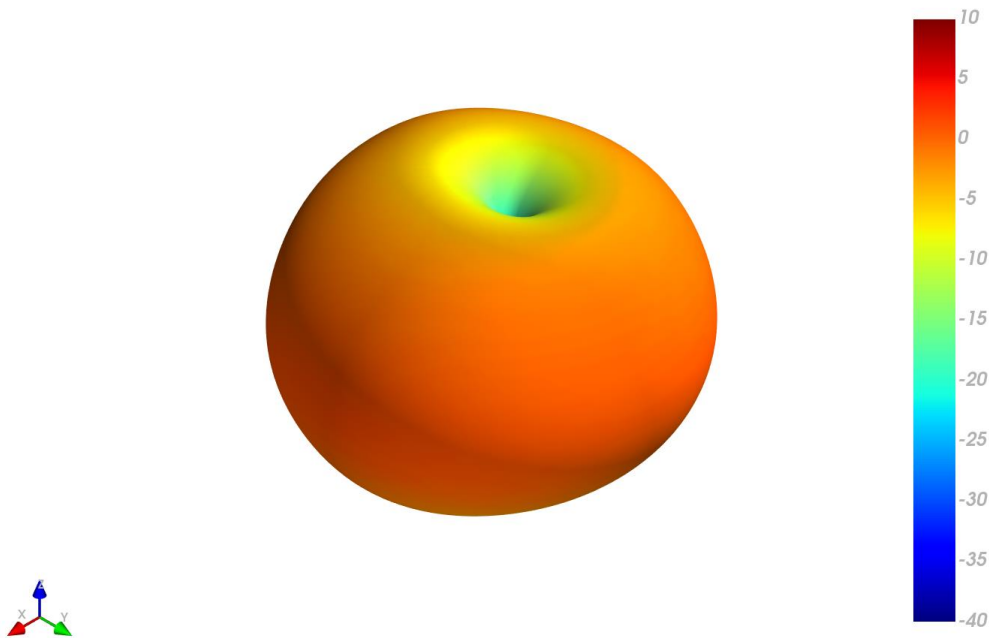

5500MHz

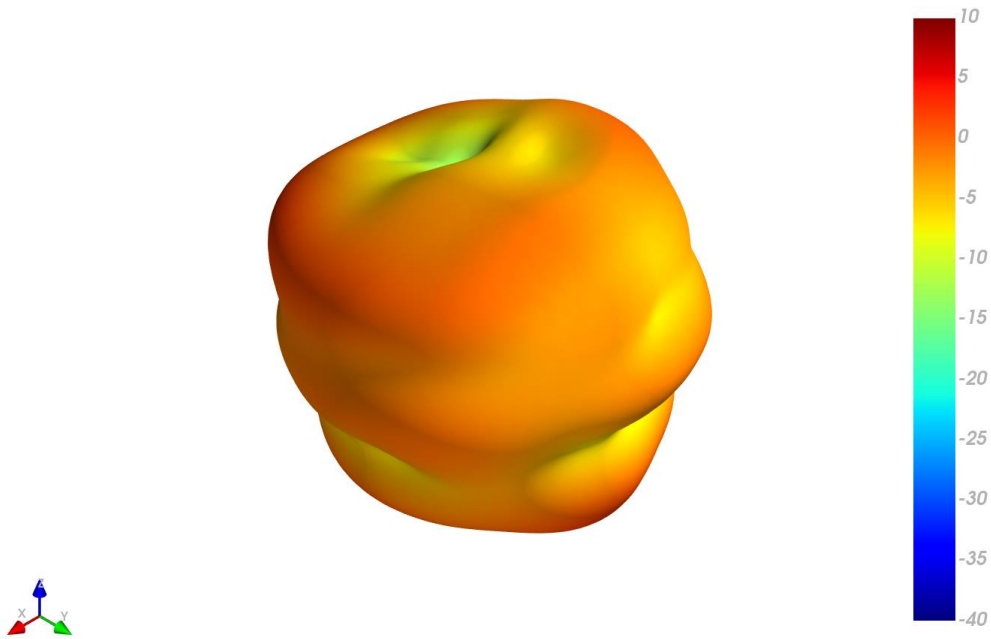

XY Plane XZ Plane YZ Plane

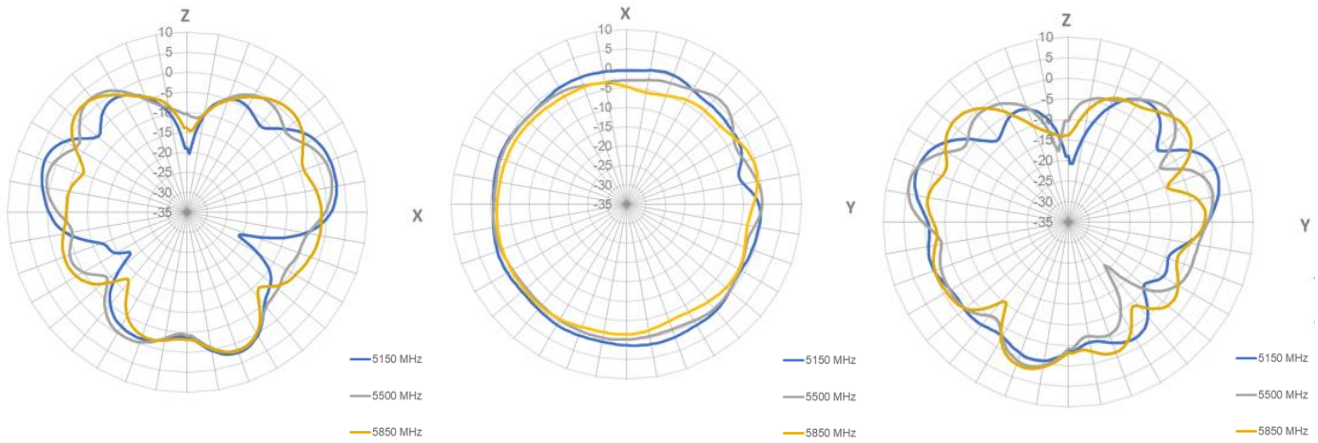

6597.47MHz

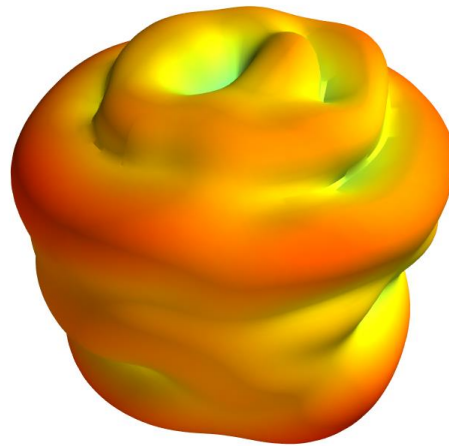

XY Plane

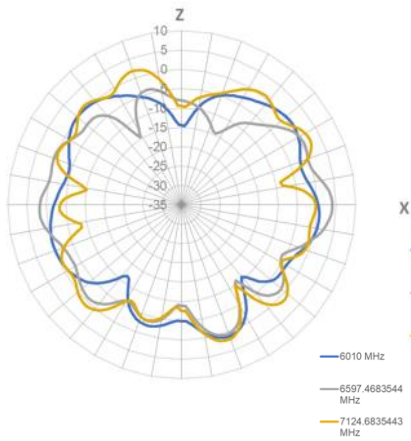

XZ Plane

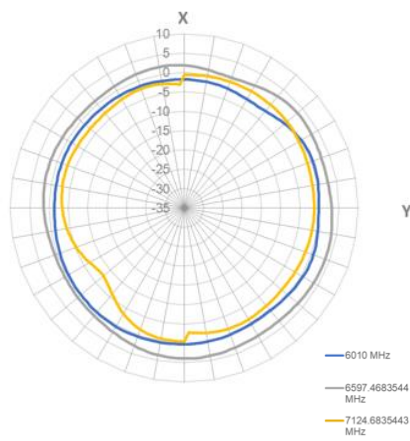

YZ Plane

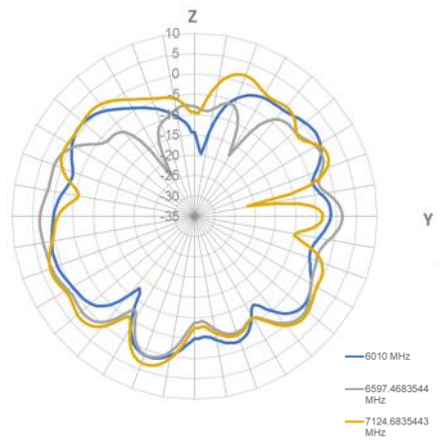

5. Mechanical Drawing (Units: mm)

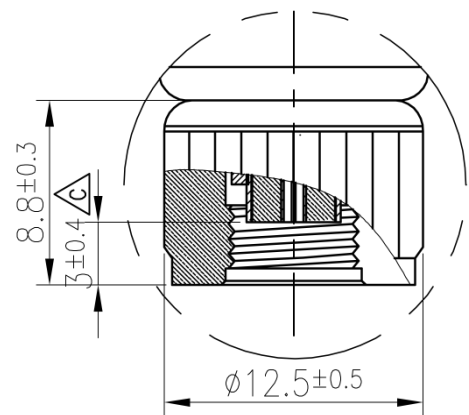
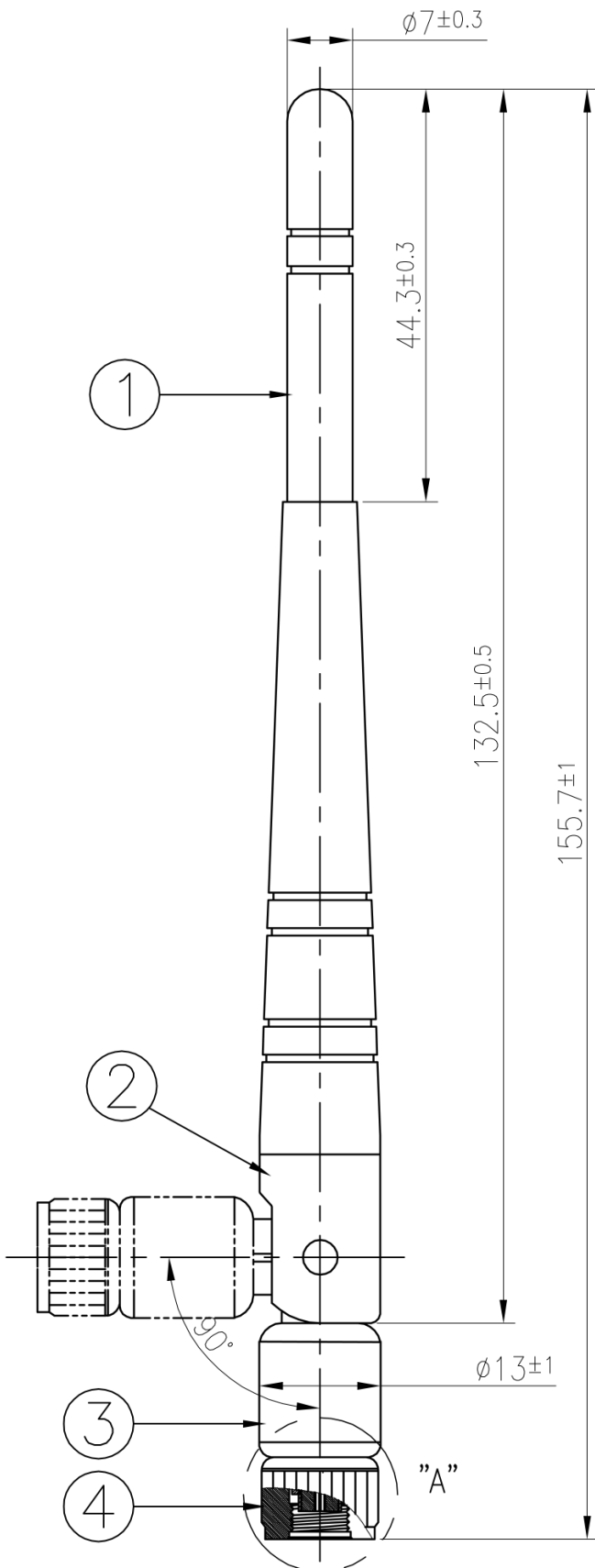

Detail A
Scale: 2:1

	Name	P/N	Material	Finish	QTY
1	Housing	000113D000002A	TPEE	Black	1
2	Base Top	000117C000002A	ABS	Black	1
3	Base Bottom	000117C010002A	PC+PBT	Black	1
4	SMA(M)RP	210213D000002A	Brass	Black	1

6. Packaging

10 pcs GW.59.3153 per PE Bag
 Bag Dimensions - 260 x 150 mm
 Weight - 175g

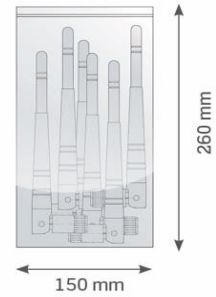

100 pcs GW.59.3153 per Large PE Large Bag
 Bag Dimensions - 430 x 250mm
 Weight - 1.78kg

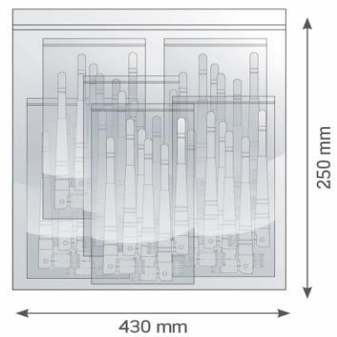

400 pcs GW.59.3153 per carton
 Carton - 360 x 310 x 160mm
 Weight - 7.6Kg

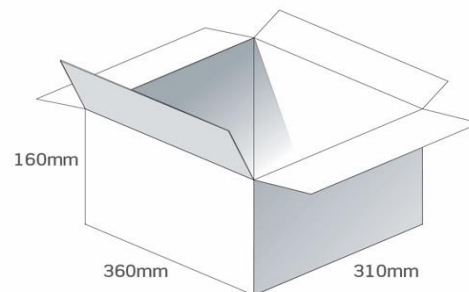

Pallet Dimensions 120 x 100 x 148cm
 72 Cartons per Pallet
 9 Cartons per layer
 8 Layers

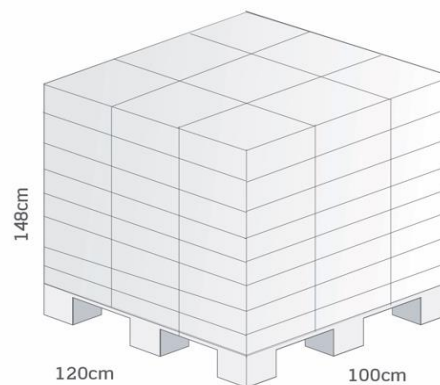

7. Application Note

7.1 GW.59 Antenna Measurement (40mm*100mm PCB Board)

On the short side

On the long side



Straight



90° Bent



Straight



90° Bent

30cm*30cm Ground Plane

50cm*50cm Ground Plane



Straight



90° Bent



Straight



90° Bent

7.2 Return loss when antenna setup on different conditions.

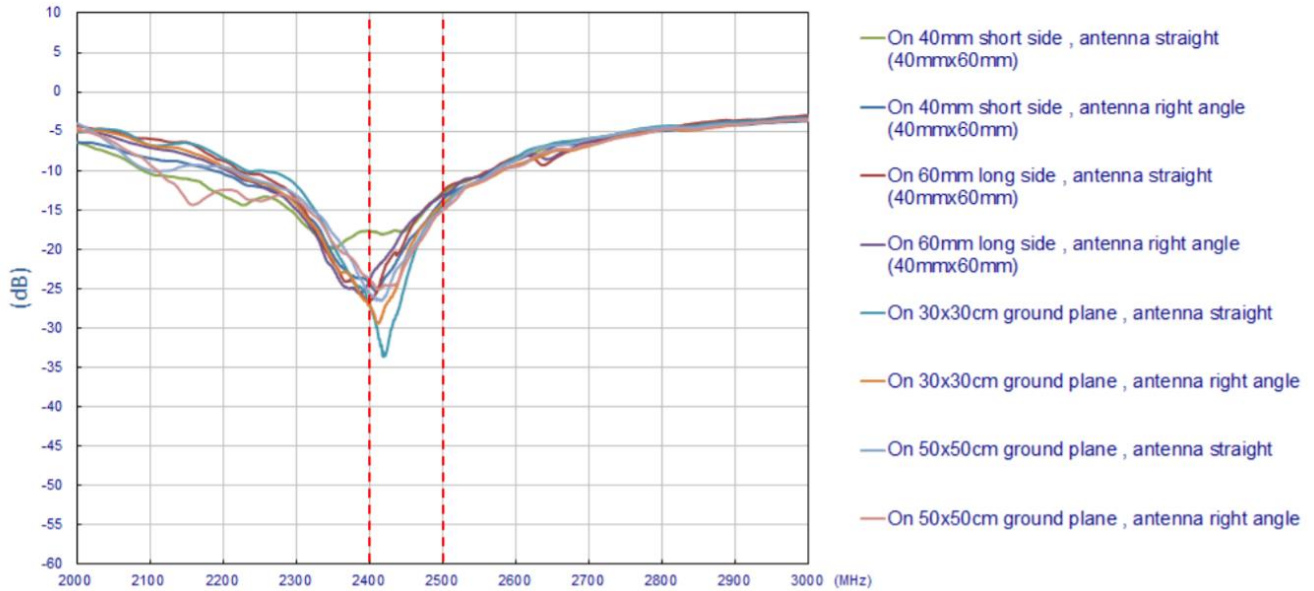

7.3 GW.57 Antenna Measurement (40mm*100mm PCB Board)

On the short side

On the long side



Straight

90° Bent

Straight

90° Bent

7.4 Return loss when antenna setup on different conditions.

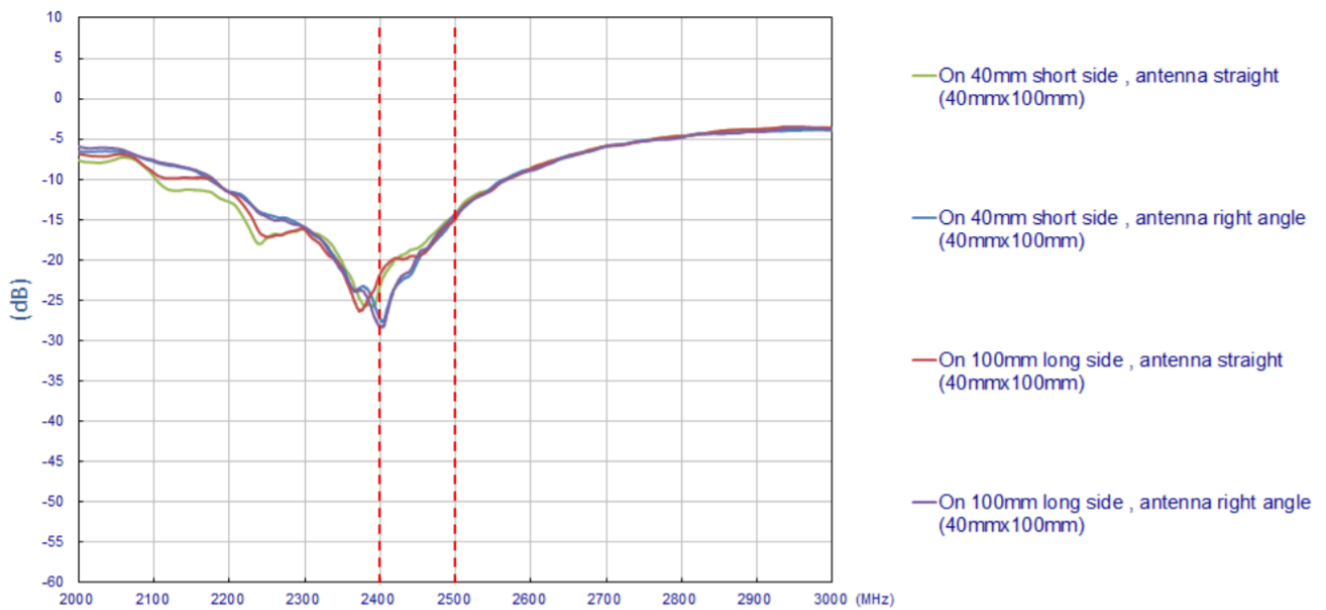

7.5 GW.59 Antenna Measurement (90mm*150mm PCB Board)

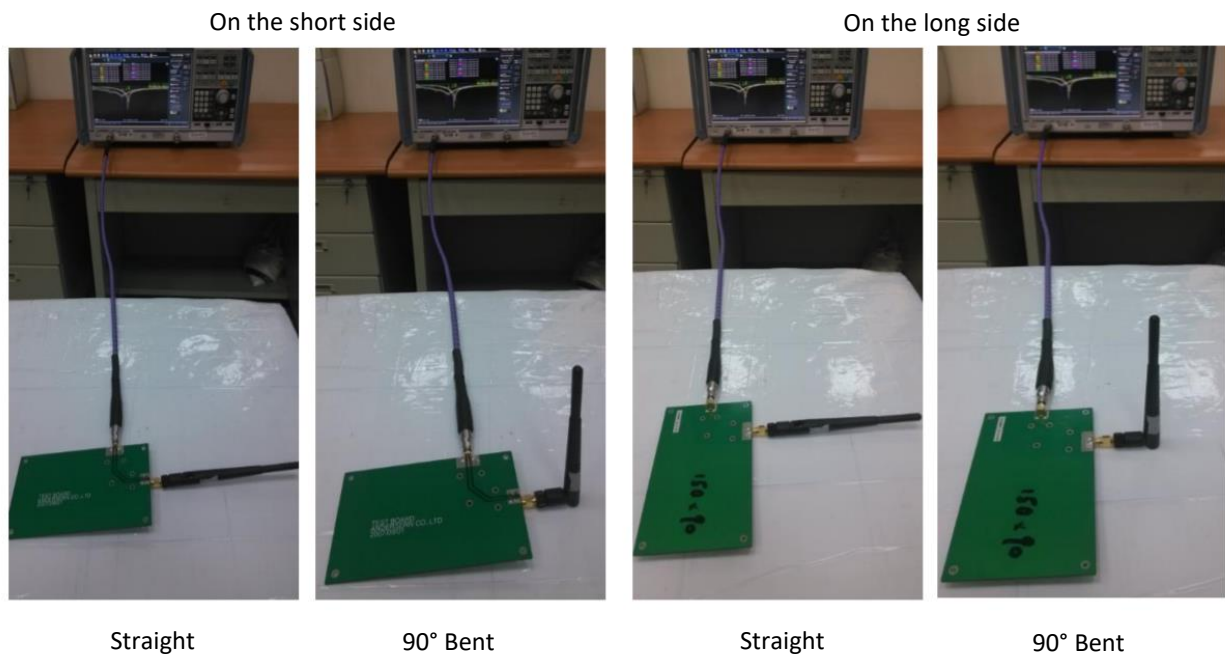

7.6 Return loss when antenna setup on different conditions

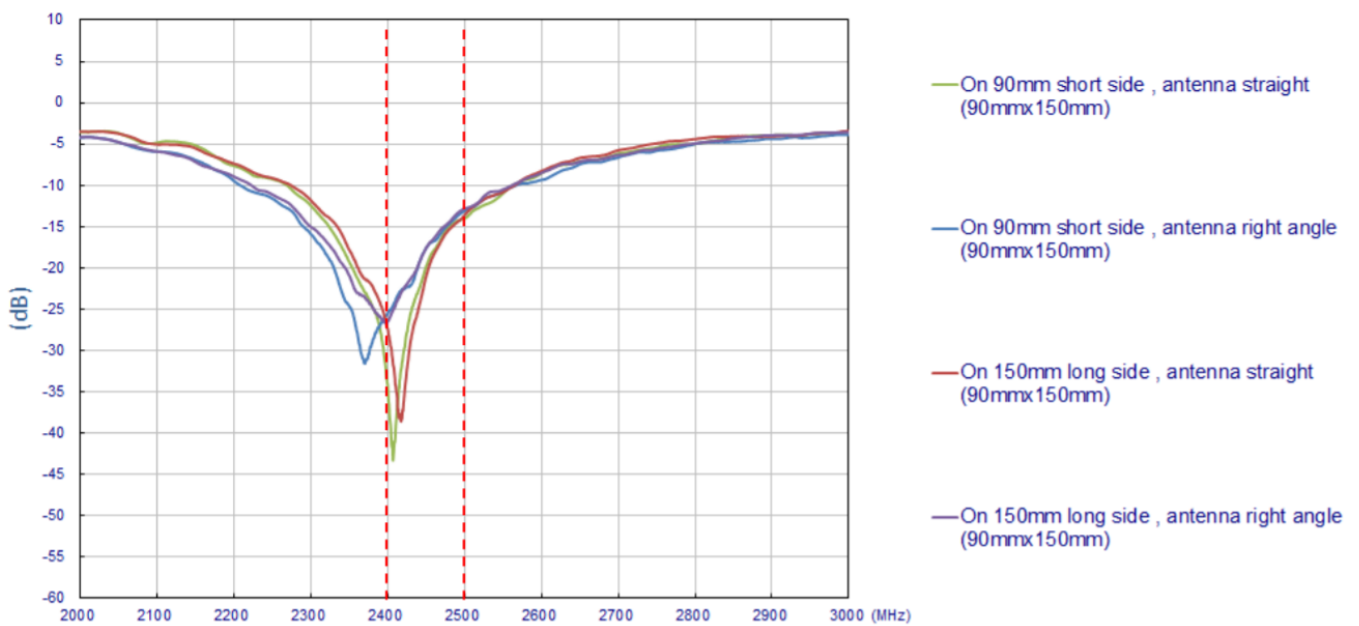

Changelog for the datasheet

SPE-11-8-134- GW.59.3153

Revision: K (Current Version)

Date:	22021-04-13
Changes:	Addition of Wi-Fi 6 and full datasheet template update
Changes Made by:	Gary West

Previous Revisions

Revision: J

Date:	202-11-09
Changes:	Updated waterproof rating
Changes Made by:	Jack Conroy

Revision: E

Date:	2015-08-24
Changes:	Amended note on Gain.
Changes Made by:	Aine Doyle

Revision: I

Date:	2019-01-29
Changes:	Updated
Changes Made by:	Jack Conroy

Revision: D

Date:	2015-02-05
Changes:	Added note on Gain.
Changes Made by:	Aine Doyle

Revision: H

Date:	
Changes:	Changed drawing
Changes Made by:	Tommy Macdonald

Revision: C

Date:	2013-07-04
Changes:	Updated version from Martin.
Changes Made by:	Aine Doyle

Revision: G

Date:	2018-10-01
Changes:	Multiple updates to description, features and packaging.
Changes Made by:	David Connolly

Revision: B

Date:	2013-03-12
Changes:	Edited radiation patterns from Wayne.
Changes Made by:	Aine Doyle

Revision: F

Date:	2017-05-10
Changes:	New drawing
Changes Made by:	Peter Monahan

Revision: A (Original First Release)

Date:	2011-11-14
Notes:	First Release
Author:	Aine Doyle