

# HCPL-0700, HCPL-0701, HCNW138, HCNW139, 6N139, 6N138,

Low Input Current, High Gain Optocouplers



## Data Sheet



### Description

These high gain series couplers use a Light Emitting Diode and an integrated high gain photodetector to provide extremely high current transfer ratio between input and output. Separate pins for the photodiode and output stage result in TTL compatible saturation voltages and high speed operation. Where desired the  $V_{CC}$  and  $V_O$  terminals may be tied together to achieve conventional photodarlington operation. A base access terminal allows a gain bandwidth adjustment to be made.

The 6N139, HCPL-0701, and HCNW139 are for use in CMOS, LSTTL or other low power applications. A 400% minimum current transfer ratio is guaranteed over 0 to 70°C operating range for only 0.5 mA of LED current.

The 6N138, HCPL-0700, and HCNW138 are designed for use mainly in TTL applications. Current Transfer Ratio (CTR) is 300% minimum over 0 to 70°C for an LED current of 1.6 mA (1TTL Unit load). A 300% minimum CTR enables operation with 1TTL Load using a 2.2 kΩ pull-up resistor.

### Functional Diagram



TRUTH TABLE	
LED	$V_O$
ON	LOW
OFF	HIGH

\* 5000 V rms/1 minute rating is for HCNW139/138 and Option 020 (6N139/138) products only. A 0.1 μF bypass capacitor connected between pins 8 and 5 is recommended.

### Features

- High current transfer ratio – 2000% typical (4500 % typical for HCNW139/138)
- Low input current requirements – 0.5 mA
- TTL compatible output – 0.1V  $V_{OL}$  typical
- Performance guaranteed over temperature 0°C to 70°C
- Base access allows gain bandwidth adjustment
- High output current – 60 mA
- Safety approval
  - UL recognized – 3750Vrms for 1 minute and 5000V rms\* for 1 minute per UL 1577
  - CSA approved
  - IEC/EN/DIN EN 60747-5-5 approved with  $V_{IORM} = 1414 V_{peak}$  for HCNW139 and HCNW138
- Available in 8-Pin DIP or SOIC-8 footprint or widebody package
- MIL-PRF-38534 hermetic version available (HCPL-5700/1)

### Applications

- Ground isolate most logic families – TTL/TTL, CMOS/TTL, CMOS/CMOS, LSTTL/TTL, CMOS/LSTTL
- Low input current line receiver
- High voltage insulation (HCNW139/138)
- EIA RS-232C line receiver
- Telephone ring detector
- 117 V ac line voltage status indicator – low input power dissipation
- Low power systems – ground isolation

**CAUTION:** It is advised that normal static precautions be taken in handling and assembly of this component to prevent damage and/or degradation which may be induced by ESD. The components featured in this datasheet are not to be used in military or aerospace applications or environments.

Selection for lower input current down to 250  $\mu\text{A}$  is available upon request.

The HCPL-0701 and HCPL-0700 are surface mount devices packaged in an industry standard SOIC-8 footprint.

The SOIC-8 does not require “through holes” in a PCB. This package occupies approximately one-third the footprint area of the standard dual-in-line package. The lead profile is designed to be compatible with standard surface mount processes.

The HCNW139 and HCNW138 are packaged in a widebody encapsulation that provides creepage and clearance dimensions suitable for safety approval by regulatory agencies worldwide.

### Selection Guide

8-Pin DIP (300 Mil)		Small Outline SO-8		Widebody (400 mil)	Minimum Input ON Current ( $I_p$ )	Minimum CTR	Absolute Maximum $V_{cc}$	Hermetic
Single Channel Package	Dual Channel Package HCPL-	Single Channel Package HCPL-	Dual Channel Package HCPL-	Package Single Channel Package				Single and Dual Channel Packages HCPL-
6N139	2731 <sup>[1]</sup>	0701	0731	HCNW139	0.5 mA	400%	18 V	
6N138	2730 <sup>[1]</sup>	0700	0730	HCNW138	1.6 mA	300%	7 V	
HCPL-4701 <sup>[1]</sup>	4731 <sup>[1]</sup>	070A <sup>[1]</sup>	073A <sup>[1]</sup>		40 $\mu\text{A}$	800%	18 V	
					0.5 mA	300%	20 V	5701 <sup>[1]</sup> 5700 <sup>[1]</sup> 5731 <sup>[1]</sup> 5730 <sup>[1]</sup>

#### Note:

1. Technical data are on separate Avago publications.

### Schematic



## Ordering Information

6N138, 6N139, HCPL-0700 and HCPL-0701 are UL Recognized with 3750 Vrms for 1 minute per UL1577 and are approved under CSA Component Acceptance Notice #5, File CA 88324.

Part Number	Option		Package	Surface Mount	Gull Wing	Tape & Reel	UL 5000 Vrms/		Quantity
	RoHS Compliant	non RoHS Compliant					1 Minute rating	IEC/EN/DIN EN 60747-5-5	
6N138	-000E	no option	300 mil DIP-8						50 per tube
6N139	-300E	#300		X	X				50 per tube
	-500E	#500		X	X	X			1000 per reel
	-020E	#020					X		50 per tube
	-320E	#320		X	X		X		50 per tube
	-520E	#520		X	X	X	X		1000 per reel
	-060E	#060						X	50 per tube
	-360E	#360		X	X			X	50 per tube
	-560E	#560		X	X	X		X	1000 per reel
HCPL-0700	-000E	no option		SO-8	X				
HCPL-0701	-500E	#500	X			X			1500 per reel
	-060E	#060	X					X	100 per tube
	-560E	#560	X			X		X	1500 per reel
HCNW138	-000E	no option	400 mil Widebody DIP-8						42 per tube
HCNW139	-300E	#300		X	X				42 per tube
	-500E	#500		X	X	X			750 per reel

To order, choose a part number from the part number column and combine with the desired option from the option column to form an order entry.

Example 1:

6N138-560E to order product of 300 mil DIP Gull Wing Surface Mount package in Tape and Reel packaging with IEC/EN/DIN EN 60747-5-5 Safety Approval and RoHS compliant.

Example 2:

HCPL-0700 to order product of 300 mil DIP package in Tube packaging and non RoHS compliant.

Option datasheets are available. Contact your Avago sales representative or authorized distributor for information.

Remarks: The notation '#XXX' is used for existing products, while (new) products launched since July 15, 2001 and RoHS compliant will use '-XXxE'.

## Package Outline Drawings

### 8-Pin DIP Package (6N139/6N138)\*\*

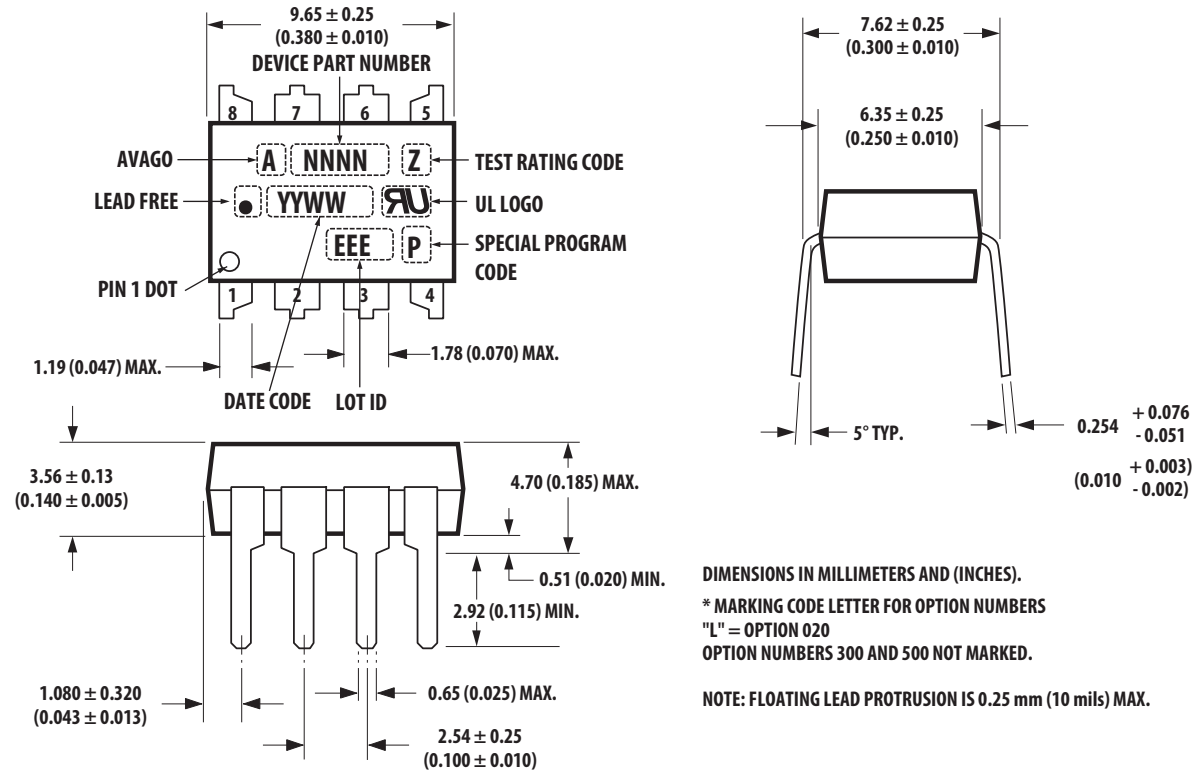

\*\*JEDEC Registered Data.

### 8-Pin DIP Package with Gull Wing Surface Mount Option 300 (6N139/6N138)



### Small Outline S0-8 Package (HCPL-0701/HCPL-0700)



\* TOTAL PACKAGE LENGTH (INCLUSIVE OF MOLD FLASH)  
5.207 ± 0.254 (0.205 ± 0.010)

DIMENSIONS IN MILLIMETERS (INCHES).  
LEAD COPLANARITY = 0.10 mm (0.004 INCHES) MAX.

NOTE: FLOATING LEAD PROTRUSION IS 0.15 mm (6 mils) MAX.

### 8-Pin Widebody DIP Package (HCNW139/HCNW138)

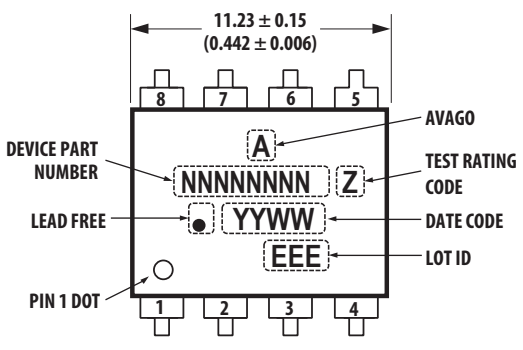

DIMENSIONS IN MILLIMETERS (INCHES).

NOTE: FLOATING LEAD PROTRUSION IS 0.25 mm (10 mils) MAX.

# 8-Pin Widebody DIP Package with Gull Wing Surface Mount Option 300 (HCNW139/HCNW138)

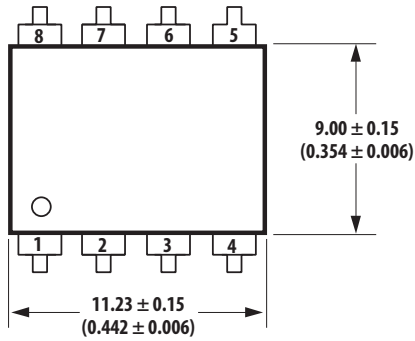

DIMENSIONS IN MILLIMETERS (INCHES).

LEAD COPLANARITY =  $0.10$  mm ( $0.004$  INCHES).

NOTE: FLOATING LEAD PROTRUSION IS  $0.25$  mm ( $10$  mils) MAX.

## Solder Reflow Profile

Recommended reflow condition as per JEDEC Standard, J-STD-020 (latest revision). Non-Halide Flux should be used.

## Regulatory Information

The 6N139/138, HCNW139/138, and HCPL-0701/0700 have been approved by the following organizations:

**UL** Recognized under UL 1577, Component Recognition Program, File E55361.

**CSA** Approved under CSA Component Acceptance Notice #5, File CA 88324.

**IEC/EN/DIN EN 60747-5-5** HCNW139/138 and Option 060/360/560 only

## Insulation and Safety Related Specifications

Parameter	Symbol	8-Pin DIP (300 Mil) Value	SO-8 Value	Widebody (400 Mil) Value	Units	Conditions
Minimum External Air Gap (External Clearance)	L(101)	7.1	4.9	9.6	mm	Measured from input terminals to output terminals, shortest distance through air.
Minimum External Tracking (External Creepage)	L(102)	7.4	4.8	10.0	mm	Measured from input terminals to output terminals, shortest distance path along body.
Minimum Internal Plastic Gap (Internal Clearance)		0.08	0.08	1.0	mm	Through insulation distance, conductor to conductor, usually the direct distance between the photoemitter and photodetector inside the optocoupler cavity.
Minimum Internal Tracking (Internal Creepage)		NA	NA	4.0	mm	Measured from input terminals to output terminals, along internal cavity.
Tracking Resistance (Comparative Tracking Index)	CTI	200	200	200	Volts	DIN IEC 112/VDE 0303 Part 1
Isolation Group		IIIa	IIIa	IIIa		Material Group (DIN VDE 0110, 1/89, Table 1)

Option 300 - surface mount classification is Class A in accordance with CECC 00802.

## IEC/EN/DIN EN 60747-5-5 Insulation Characteristics (HCNW139 and HCNW138)

Description	Symbol	Characteristic	Unit
Installation classification per DIN VDE 0110, Table 1 for rated mains voltage $\leq 150$ Vrms for rated mains voltage $\leq 300$ Vrms for rated mains voltage $\leq 600$ Vrms for rated mains voltage $\leq 1000$ Vrms		I – IV I – IV I – IV I – III	
Climatic Classification		0/70/21	
Pollution Degree (DIN VDE 0110/39)		2	
Maximum Working Insulation Voltage	$V_{IORM}$	1414	$V_{peak}$
Input to Output Test Voltage, Method b* $V_{IORM} \times 1.875 = V_{PR}$ 100% Production Test with $t_m = 1$ sec, Partial discharge $< 5$ pC	$V_{PR}$	2651	$V_{peak}$
Input to Output Test Voltage, Method a* $V_{IORM} \times 1.6 = V_{PR}$ Type and Sample Test, $t_m = 10$ sec, Partial discharge $< 5$ pC	$V_{PR}$	2262	$V_{peak}$
Highest Allowable Overvoltage (Transient Overvoltage $t_{ini} = 60$ sec)	$V_{IOTM}$	8000	$V_{peak}$
Safety-limiting values – maximum values allowed in the event of a failure.			
Case Temperature	$T_S$	150	°C
Input Current	$I_{S, INPUT}$	400	mA
Output Power	$P_{S, OUTPUT}$	700	mW
Insulation Resistance at $T_s, V_{IO} = 500$ V	$R_S$	$> 10^9$	$\Omega$

\*Refer to the front of the optocoupler section of the current catalog, under Product Safety Regulations section, IEC/EN/DIN EN 60747-5-5, for a detailed description.

Note: Isolation characteristics are guaranteed only within the safety maximum ratings which must be ensured by protective circuits in application.



### Absolute Maximum Ratings\* (No Derating Required up to 85°C)

Parameter	Symbol	Min.	Max.	Units
Storage Temperature	$T_S$	-55	125	°C
Operating Temperature**	$T_A$	-40	85	°C
Average Forward Input Current	$I_{F(AVG)}$		20	mA
Peak Forward Input Current (50% Duty Cycle, 1 ms Pulse Width)	$I_{FPK}$		40	mA
Peak Transient Input Current ( $<1 \mu s$ Pulse Width, 300 pps)	$I_{F(TRAN)}$		1.0	A
Reverse Input Voltage	$V_R$		5	V
		HCNW139/138	3	V
Input Power Dissipation	$P_I$		35	mW
Output Current (Pin 6)	$I_O$		60	mA
Emitter Base Reverse Voltage (Pin 5-7)	$V_{EB}$		0.5	V
Supply Voltage and Output Voltage (6N139, HCPL-0701, HCNW139)	$V_{CC}$	-0.5	18	V
Supply Voltage and Output Voltage (6N138, HCPL-0700, HCNW138)	$V_{CC}$	-0.5	7	V
Output Power Dissipation	$P_O$		100	mW
Total Power Dissipation	$P_T$		135	mW
Lead Solder Temperature (for Through Hole Devices)		260°C for 10 sec., 1.6 mm below seating plane		
	HCNW139/138	260°C for 10 sec., up to seating plane		
Reflow Temperature Profile (for SOIC-8 and Option #300)		See Package Outline Drawings section		

\*JEDEC Registered Data for 6N139 and 6N138.

\*\*0°C to 70°C on JEDEC Registration.

### Recommended Operating Conditions

Parameter	Symbol	Min.	Max.	Units
Power Supply Voltage	$V_{CC}$	4.5	18	V
Forward Input Current (ON)	$I_{F(ON)}$	0.5	12.0	mA
Forward Input Voltage (OFF)	$V_{F(OFF)}$	0	0.8	V
Operating Temperature	$T_A$	0	70	°C

## Electrical Specifications

$0^{\circ}\text{C} \leq T_A \leq 70^{\circ}\text{C}$ ,  $4.5\text{ V} \leq V_{\text{CC}} \leq 18\text{ V}$ ,  $0.5\text{ mA} \leq I_{\text{F(ON)}} \leq 12\text{ mA}$ ,  $0\text{ V} \leq V_{\text{F(OFF)}} \leq 0.8\text{ V}$ , unless otherwise specified.  
All Typicals at  $T_A = 25^{\circ}\text{C}$ . See Note 7.

Parameter	Sym.	Device	Min.	Typ.**	Max.	Units	Test Conditions	Fig.	Note
Current Transfer Ratio	CTR	6N139	400*	2000	5000	%	$I_F = 0.5\text{ mA}$ $V_{\text{CC}} = 4.5$ $V_O = 0.4\text{ V}$	2, 3	1, 2, 4
		HCPL-0701							
		HCNW139	400	4500					
		6N139	500*	1600	2600		$I_F = 1.6\text{ mA}$		
		HCPL-0701							
		HCNW139	500	3000					
			300	1600			$I_F = 5.0\text{ mA}$		
			200	850			$I_F = 12\text{ mA}$		
Logic Low Output Voltage	$V_{\text{OL}}$	6N139		0.1	0.4	V	$I_F = 0.5\text{ mA}$ , $I_O = 2\text{ mA}$ $V_{\text{CC}} = 4.5$	1	2
		HCPL-0701							
		HCNW139					$I_F = 1.6\text{ mA}$ , $I_O = 8\text{ mA}$		
							$I_F = 5.0\text{ mA}$ , $I_O = 15\text{ mA}$		
				0.2			$I_F = 12\text{ mA}$ , $I_O = 24\text{ mA}$		
		6N138		0.1			$I_F = 1.6\text{ mA}$ , $I_O = 4.8\text{ mA}$		
		HCPL-0700							
		HCNW138							
Logic High Output Current	$I_{\text{OH}}$	6N139		0.05	100	$\mu\text{A}$	$V_O = V_{\text{CC}} = 18\text{ V}$ $I_F = 0\text{ mA}$		2
		HCPL-0701							
		HCNW139							
Logic Low Supply Current	$I_{\text{CCL}}$	6N138/139		0.4	1.5	mA	$I_F = 1.6\text{ mA}$ , $V_O = \text{Open}$ , $V_{\text{CC}} = 18\text{ V}$	10	2
		HCPL-0701/0700							
		HCNW139		0.5	2				
Logic High Supply Current	$I_{\text{CCH}}$	6N138/139		0.01	10	$\mu\text{A}$	$I_F = 0\text{ mA}$ , $V_O = \text{Open}$ , $V_{\text{CC}} = 18\text{ V}$		2
		HCPL-0701/0700							
		HCNW139			1				
		HCNW138							
Input Forward Voltage	$V_F$	6N138	1.25	1.40	1.7*	V	$T_A = 25^{\circ}\text{C}$ , $I_F = 1.6\text{ mA}$		4, 8
		6N139			1.75				
		HCPL-0701							
		HCPL-0700							
		HCNW139	1.0	1.45	1.85		$T_A = 25^{\circ}\text{C}$		
Input Reverse Breakdown Voltage	BVR	HCNW139	5.0*			V	$I_R = 10\text{ }\mu\text{A}$ , $T_A = 25^{\circ}\text{C}$		
		HCNW138	3.0				$I_R = 100\text{ }\mu\text{A}$ , $T_A = 25^{\circ}\text{C}$		
		HCNW138							
Temperature Coefficient of Forward Voltage		$\Delta V_F$ $\Delta T_A$		-1.8		mV/ $^{\circ}\text{C}$	$I_F = 1.6\text{ mA}$		8
Input Capacitance	$C_{\text{IN}}$			60		pF	$f = 1\text{ MHz}$ , $V_F = 0\text{ V}$		
		HCNW139		90					
		HCNW138							

\* JEDEC Registered Data for 6N139 and 6N138.

\*\*All typical values at  $T_A = 25^{\circ}\text{C}$  and  $V_{\text{CC}} = 5\text{ V}$ , unless otherwise noted.

## Switching Specifications (AC)

Over recommended operating conditions ( $T_A = 0$  to  $70^\circ\text{C}$ ),  $V_{CC} = 5\text{ V}$ , unless otherwise specified.

Parameter	Sym.	Device	Min.	Typ.**	Max.	Units	Test Conditions	Fig.	Note	
										$T_A = 25^\circ\text{C}$
Propagation Delay Time to Logic Low at Output	$t_{PHL}$	6N139 HCPL-0701 HCNW139	5 12	25*	30	$\mu\text{s}$	$I_F = 0.5\text{ mA}$ , $R_I = 4.7\text{ k}\Omega$	5, 6, 7, 9,	2, 4	
		6N139 HCPL-0701 HCNW139	0.2 11	1*	2	$\mu\text{s}$	$I_F = 12\text{ mA}$ , $R_I = 270\ \Omega$			
		6N138 HCPL-0700 HCNW138	1.6 11	10*	15	$\mu\text{s}$	$I_F = 1.6\text{ mA}$ , $R_I = 2.2\text{ k}\Omega$			
		6N139 HCPL-0701 HCNW139	18 115 12	60*	90	$\mu\text{s}$	$I_F = 0.5\text{ mA}$ , $R_I = 4.7\text{ k}\Omega$	5, 6, 7, 9,	2, 4	
Propagation Delay Time to Logic High at Output	$t_{PLH}$	6N139 HCPL-0701 HCNW139	2 11	7*	10	$\mu\text{s}$	$I_F = 12\text{ mA}$ , $R_I = 270\ \Omega$			
		6N138 HCPL-0700 HCNW138	10 70	35*	50	$\mu\text{s}$	$I_F = 1.6\text{ mA}$ , $R_I = 2.2\text{ k}\Omega$			
		Common Mode Transient Immunity at Logic High Output	$ CM_H $	1000	10000		$V/\mu\text{s}$	$I_F = 0\text{ mA}$ , $T_A = 25^\circ\text{C}$ $R_I = 2.2\text{ k}\Omega$ $ V_{CM}  = 10$ $V_{p-p}$	13	5, 6
		Common Mode Transient Immunity at Logic Low Output	$ CM_L $	1000	10000		$V/\mu\text{s}$	$I_F = 1.6\text{ mA}$ , $T_A = 25^\circ\text{C}$ $R_I = 2.2\text{ k}\Omega$ $ V_{CM}  = 10$ $V_{p-p}$	13	5, 6

\* JEDEC Registered Data for 6N139 and 6N138.

\*\*All typical values at  $T_A = 25^\circ\text{C}$  and  $V_{CC} = 5\text{ V}$ , unless otherwise noted.

## Package Characteristics

Parameter	Sym.	Min.	Typ.**	Max.	Units	Test Conditions	Fig.	Note
Input-Output Momentary Withstand Voltage†	V <sub>ISO</sub>	3750			V rms	RH < 50%, t = 1 min., T <sub>A</sub> = 25°C		3, 8
		Option 020 HCNW139 HCNW138	5000					
Resistance (Input-Output)	R <sub>I-O</sub>		10 <sup>12</sup>		Ω	V <sub>I-O</sub> = 500 Vdc RH < 45%		3
Capacitance (Input-Output)	C <sub>I-O</sub>		0.6		pF	f = 1 MHz		3

\*\*All typicals at T<sub>A</sub> = 25°C, unless otherwise noted.

†The Input-Output Momentary Withstand Voltage is a dielectric voltage rating that should not be interpreted as an input-output continuous voltage rating. For the continuous voltage rating refer to the IEC/EN/DIN EN 60747-5-5 Insulation Characteristics Table (if applicable), your equipment level safety specification or Avago Application Note 1074 entitled "Optocoupler Input-Output Endurance Voltage."

### Notes:

- DC CURRENT TRANSFER RATIO (CTR) is defined as the ratio of output collector current, I<sub>O</sub>, to the forward LED input current, I<sub>F</sub>, times 100%.
- Pin 7 Open.
- Device considered a two-terminal device. Pins 1, 2, 3, and 4 shorted together and Pins 5, 6, 7, and 8 shorted together.
- Use of a resistor between pin 5 and 7 will decrease gain and delay time. Significant reduction in overall gain can occur when using resistor values below 47 kΩ. For more information, please contact your local Avago Components representative.
- Common mode transient immunity in a Logic High level is the maximum tolerable (positive) dV<sub>CM</sub>/dt of the common mode pulse, V<sub>CM</sub>, to assure that the output will remain in a Logic High state (i.e., V<sub>O</sub> > 2.0 V). Common mode transient immunity in a Logic Low level is the maximum tolerable (negative) dV<sub>CM</sub>/dt of the common mode pulse, V<sub>CM</sub>, to assure that the output will remain in a Logic Low state (i.e., V<sub>O</sub> < 0.8 V).
- In applications where dV/dt may exceed 50,000 V/μs (such as static discharge) a series resistor, R<sub>CC</sub>, should be included to protect the detector IC from destructively high surge currents. The recommended value is R<sub>CC</sub> = 220 Ω.
- Use of a 0.1 μF bypass capacitor connected between pins 8 and 5 adjacent to the device is recommended.
- In accordance with UL 1577, each optocoupler is proof tested by applying an insulation test voltage 4500 V rms for 1 second (leakage detection current limit, I<sub>I-O</sub> < 5 μA). This test is performed before the 100% production test shown in the IEC/EN/DIN EN 60747-5-5 Insulation Related Characteristics Table, if applicable.
- In accordance with UL 1577, each optocoupler is proof tested by applying an insulation test voltage > 6000 V rms for 1 second (leakage detection current limit, I<sub>I-O</sub> < 5 μA). This test is performed before the 100% production test for partial discharge (method b) shown in the IEC/EN/DIN EN 60747-5-5 Insulation Related Characteristics Table, if applicable.

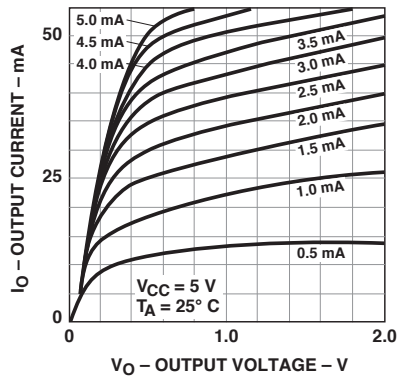

Figure 1. 6N138/6N139 DC transfer characteristics

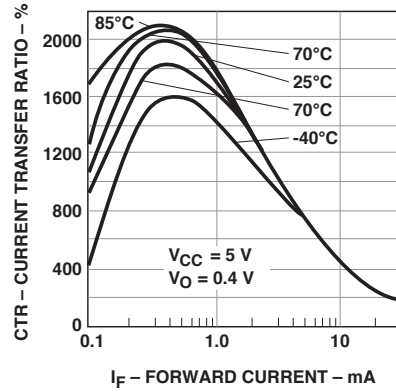

Figure 2. Current transfer ratio vs. forward current 6N138/6N139

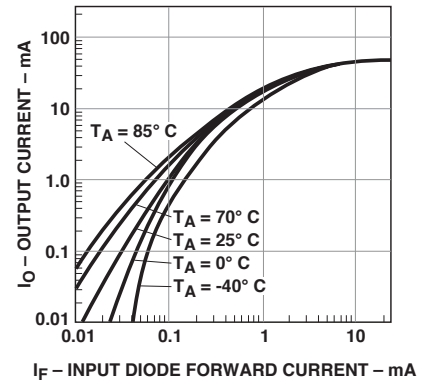

Figure 3. 6N138/6N139 output current vs. input diode forward current



Figure 4. Input diode forward current vs. forward voltage



Figure 5. Propagation delay vs. temperature



Figure 6. Propagation delay vs. temperature



Figure 7. Propagation delay vs. temperature



Figure 8. Forward voltage vs. temperature

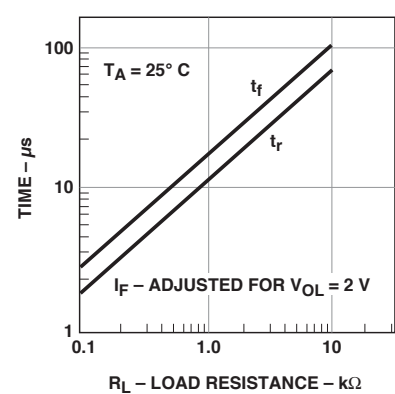

Figure 9. Nonsaturated rise and fall times vs. load resistance