

# HCPL-250L/050L/253L/053L

## LVTTTL/LVCMOS Compatible 3.3 V Optocouplers (1 Mb/s)



### Data Sheet



#### Description

These diode-transistor optocouplers use an insulating layer between a LED and an integrated photodetector to provide electrical insulation between input and output. Separate connections for the photodiode bias and output-transistor collector increase the speed up to a hundred times that of a conventional photo-transistor coupler by reducing the base-collector capacitance.

These optocouplers are available in an 8-pin DIP and in an industry standard SO-8 package. The following is a cross reference table listing the 8-pin DIP part number and the electrically equivalent SO-8 part number.

The SO-8 does not require "through holes" in a PCB. This package occupies approximately one-third the footprint area of the standard dual-in-line package. The lead profile is designed to be compatible with standard surface mount processes.

These optocouplers can be used in LVTTTL/LVCMOS or wide bandwidth analog applications.

The common mode transient immunity of 1000 V/ $\mu$ s minimum to typical at VCM = 10 V guaranteed for these optocouplers.

8-Pin DIP	SO-8 Package
HCPL-250L	HCPL-050L
HCPL-253L	HCPL-053L

#### Features

- 3.3V/5V Dual Supply Voltages
- Low power consumption
- High speed: 1 Mb/s
- LVTTTL/LVCMOS compatible
- Available in 8-pin DIP, SO-8
- Open collector output
- Guaranteed performance from temperature: 0°C to +70°C
- Safety approval, UL, CSA, IEC/EN/DIN EN 60747-5-2

#### Applications

- High voltage insulation
- Video signal isolation
- Power translator isolation in motor drives
- Line receivers
- Feedback element in switched mode power supplies
- High speed logic ground isolation – LVTTTL/LVCMOS
- Replaces pulse transformers
- Replaces slow phototransistor isolators

#### Functional Diagram

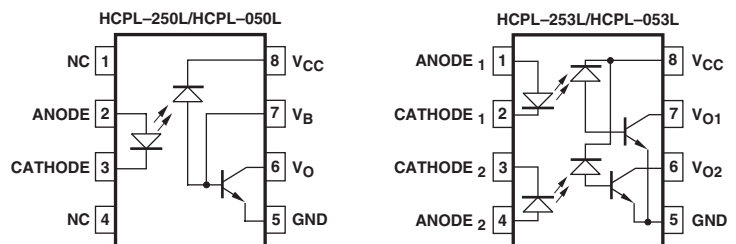

TRUTH TABLE  
(POSITIVE LOGIC)

LED	V <sub>O</sub>
ON	LOW
OFF	HIGH

A 0.1  $\mu$ F bypass capacitor must be connected between pins 5 and 8.

**CAUTION:** It is advised that normal static precautions be taken in handling and assembly of this component to prevent damage and/or degradation which may be induced by ESD.

## Ordering Information

HCPL-250L, HCPL-253L, HCPL-050L and HCPL-053L are UL Recognized with 3750 Vrms for 1 minute per UL1577 and are approved under CSA Component Acceptance Notice #5, File CA 88324.

Part Number	Option		Package	Surface Mount	Gull Wing	Tape & Reel	UL 5000 Vrms/ 1 Minute rating	IEC/EN/DIN EN 60747-5-2	Quantity
	RoHS Compliant	non RoHS Compliant							
	-000E	no option	300 mil DIP-8						50 per tube
	-300E	-300		X	X				50 per tube
	-500E	-500		X	X	X			1000 per reel
HCPL-250L	-020E	-020					X		50 per tube
HCPL-253L	-320E	-320		X	X		X		50 per tube
	-520E	-520		X	X	X	X		1000 per reel
	-060E	-060						X	50 per tube
	-360E	-360		X	X			X	50 per tube
	-560E	-560		X	X	X		X	1000 per reel
HCPL-050L	-000E	no option	SO-8						100 per tube
HCPL-053L	-500E	-500		X	X	X			1500 per reel

To order, choose a part number from the part number column and combine with the desired option from the option column to form an order entry.

Example 1:

HCPL-253L-560E to order product of 300 mil DIP Gull Wing Surface Mount package in Tape and Reel packaging with IEC/EN/DIN EN 60747-5-2 Safety Approval and RoHS compliant.

Example 2:

HCPL-253L to order product of 300 mil DIP package in Tube packaging and non RoHS compliant.

Option datasheets are available. Contact your Avago sales representative or authorized distributor for information. Remarks: The notation '#XXX' is used for existing products, while (new) products launched since July 15, 2001 and RoHS compliant will use '-XXxE'.

# Schematic

HCPL-250L/HCPL-050L



HCPL-253L/HCPL-053L

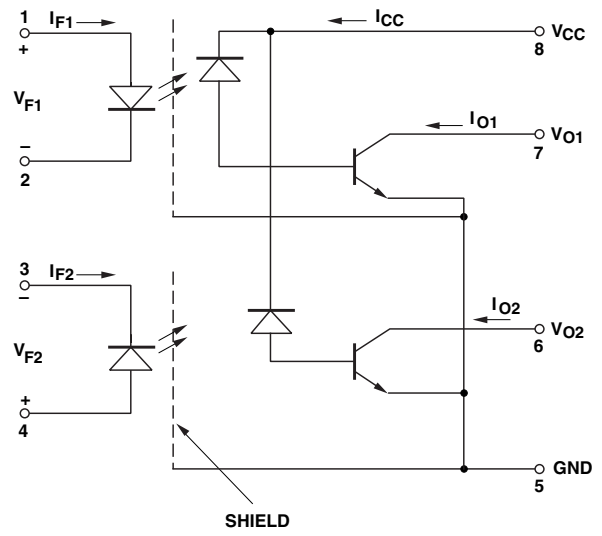

# Package Outline Drawings

## 8-Pin DIP Package



DIMENSIONS IN MILLIMETERS AND (INCHES).  
 \* MARKING CODE LETTER FOR OPTION NUMBERS  
 "V" = OPTION 060  
 OPTION NUMBERS 300 AND 500 NOT MARKED.

NOTE: FLOATING LEAD PROTRUSION IS 0.25 mm (10 mils) MAX.

## Small Outline SO-8 Package



\* TOTAL PACKAGE LENGTH (INCLUSIVE OF MOLD FLASH)  
 5.207 ± 0.254 (0.205 ± 0.010)

DIMENSIONS IN MILLIMETERS (INCHES).  
 LEAD COPLANARITY = 0.10 mm (0.004 INCHES) MAX.

OPTION NUMBER 500 NOT MARKED.

NOTE: FLOATING LEAD PROTRUSION IS 0.15 mm (6 mils) MAX.

## Solder Reflow Temperature Profile



Note: Non-halide flux should be used.

## Recommended Pb-Free IR Profile

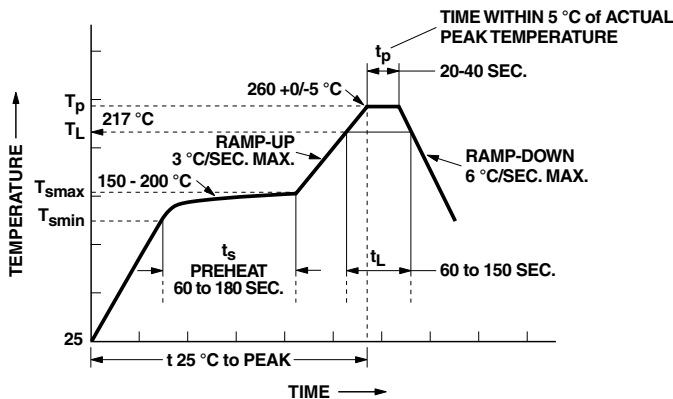

NOTES:  
 THE TIME FROM 25 °C to PEAK TEMPERATURE = 8 MINUTES MAX.  
 $T_{smax} = 200^{\circ}\text{C}$ ,  $T_{smin} = 150^{\circ}\text{C}$

Note: Non-halide flux should be used.

## Regulatory Information

The devices contained in this data sheet have been approved by the following organizations:

### UL

Approval under UL 1577, Component Recognition Program, File E55361.

### CSA

Approval under CSA Component Acceptance Notice #5, File CA 88324.

### IEC/EN/DIN EN 60747-5-2

Approved under :

IEC 60747-5-2:1997 + A1:2002

EN 60747-5-2:2001 + A1:2002

DIN EN 60747-5-2 (VDE 0884Teil 2):2003-01

## Insulation and Safety Related Specifications

Parameter	Symbol	8-Pin DIP (300 Mil)	SO-8	Units	Conditions
		Value	Value		
Minimum External Air Gap (External Clearance)	L (101)	7.1	4.9	mm	Measured from input terminals to output terminals, shortest distance through air.
Minimum External Tracking (External Creepage)	L (102)	7.4	4.8	mm	Measured from input terminals to output terminals, shortest distance path along body.
Minimum Internal Plastic Gap (Internal Clearance)		0.08	0.08	mm	Through insulation distance, conductor to conductor, usually the direct distance between the photoemitter and photodetector inside the optocoupler cavity.
Tracking Resistance (Comparative Tracking Index)	CTI	200	200	Volts	DIN IEC 112/VDE 0303 Part 1
Isolation Group		IIIa	IIIa		Material Group (DIN VDE 0110, 1/89, Table 1)

## IEC/EN/DIN EN 60747-5-2 Insulation Related Characteristics

Description	Symbol	PDIP Option 060	SO-8 Option 60	Units
Installation classification per DIN VDE 0110/1.89, Table 1 for rated mains voltage ≤ 150 V rms for rated mains voltage ≤ 300 V rms for rated mains voltage ≤ 600 V rms			I-IV I-III I-II	
Climatic Classification		55/85/21	55/85/21	
Pollution Degree (DIN VDE 0110/1.89)		2	2	
Maximum Working Insulation Voltage	$V_{IORM}$	630	566	$V_{peak}$
Input to Output Test Voltage, Method b* $V_{IORM} \times 1.875 = V_{PR}$ , 100% Production Test with $t_m = 1$ sec, Partial Discharge < 5 pC	$V_{PR}$	1181	1063	$V_{peak}$
Input to Output Test Voltage, Method a* $V_{IORM} \times 1.5 = V_{PR}$ , Type and Sample Test, $t_m = 60$ sec, Partial Discharge < 5 pC	$V_{PR}$	945	849	$V_{peak}$
Highest Allowable Overvoltage* (Transient Overvoltage, $t_{ini} = 10$ sec)	$V_{IOTM}$	6000	4000	$V_{peak}$
Safety Limiting Values (Maximum values allowed in the event of a failure, also see Figure 16, Thermal Derating curve.)				
Case Temperature	$T_S$	175	150	°C
Input Current	$I_{S,INPUT}$	230	150	mA
Output Power	$P_{S,OUTPUT}$	600	600	mW
Insulation Resistance at $T_S$ , $V_{IO} = 500$ V	$R_S$	$\geq 10^9$	$\geq 10^9$	$\Omega$

\*Refer to the front of the optocoupler section of the current catalog, under Product Safety Regulations section, IEC/EN/DIN EN 60747-5-2, for a detailed description.

Note: Isolation characteristics are guaranteed only within the safety maximum ratings which must be ensured by protective circuits in application.

## Absolute Maximum Ratings

Parameter	Symbol	Min.	Max.	Units	Note
Storage Temperature	$T_S$	-55	125	°C	
Operating Temperature	$T_A$	-55	100	°C	
Average Forward Input Current	$I_{F(AVG)}$		25	mA	1
Peak Forward Input Current (50% duty cycle, 1 ms pulse width)	$I_{F(PEAK)}$		50	mA	2
Peak Transient Input Current ( $\leq 1 \mu s$ pulse width, 300 pps)	$I_{F(TRANS)}$		1	A	
Reverse LED Input Voltage (Pin 3-2)	$V_R$		5	V	
Input Power Dissipation	$P_{IN}$		45	mW	3
Average Output Current (Pin 6)	$I_{O(AVG)}$		8	mA	
Peak Output Current	$I_{O(PEAK)}$		16	mA	
Emitter-Base Reverse Voltage	$V_{EBR}$		5	V	
Supply Voltage (Pin 8-5)	$V_{CC}$	-0.5	7	V	
Output Voltage (Pin 6-5)	$V_O$	-0.5	7	V	
Base Current	$I_B$		5	mA	
Output Power Dissipation	$P_O$		100	mW	4
Lead Solder Temperature (Through Hole Parts Only) 1.6 mm below seating plane, 10 sec. up to seating plane, 10 seconds	$T_{LS}$		260 260	°C °C	
Reflow Temperature Profile	$T_{RP}$	See Package Outline Drawings section			

## Recommended Operating Conditions

Parameter	Symbol	Min.	Max.	Units
Power Supply Voltage	$V_{CC}$	2.7	7.0	V
Forward Input Current	$I_{F(ON)}$	16	20	mA
Forward Input Voltage	$V_{F(OFF)}$	0	0.8	V
Operating Temperature	$T_A$	0	85	°C

## Electrical Specifications (DC)

Over Recommended Temperature ( $T_A = 0^\circ\text{C}$  to  $+70^\circ\text{C}$ ),  $V_{CC} = 3.3\text{ V}$ ,  $I_F = 16\text{ mA}$ , unless otherwise specified. See Note 13.

Parameter	Sym.	Device	Min.	Typ.	Max.	Units	Test Conditions	Fig.	Note
Current Transfer Ratio	CTR		15	20	50	%	$T_A = 25^\circ\text{C}$ $V_O = 0.4\text{ V}$ $I_F = 16\text{ mA}$ , $V_{CC} = 3.3\text{ V}$	2	5, 11
Logic Low Output Voltage	$V_{OL}$			0.05	0.3	V	$T_A = 25^\circ\text{C}$ $I_O = 3.0\text{ mA}$ $I_F = 16\text{ mA}$ , $V_{CC} = 3.3\text{ V}$		
Logic High Output Current	$I_{OH}$			0.003	1	$\mu\text{A}$	$T_A = 25^\circ\text{C}$ $V_O = V_{CC} = 3.3\text{ V}$ $I_F = 0\text{ mA}$	4	
Logic Low Supply Current	$I_{CCL}$	HCPL-050L HCPL-250L HCPL-053L HCPL-253L		43.0	100	$\mu\text{A}$	$I_F = 16\text{ mA}$ , $V_O = \text{Open}$ , $V_{CC} = 3.3\text{ V}$		13
Logic High Supply Current	$I_{CCH}$	HCPL-050L HCPL-250L HCPL-053L HCPL-253L		0.005	0.3	$\mu\text{A}$	$T_A = 25^\circ\text{C}$ $I_F = 0\text{ mA}$ , $V_O = \text{Open}$ , $V_{CC} = 3.3\text{ V}$		13
Input Forward Voltage	$V_F$			1.52	1.7	V	$T_A = 25^\circ\text{C}$ $I_F = 16\text{ mA}$		1
Input Reverse Breakdown Voltage	$BV_R$		5			V	$I_R = 10\ \mu\text{A}$		
Input Capacitance	$C_{IN}$			60		pF	$f = 1\text{ MHz}$ , $V_F = 0\text{ V}$		

## Electrical Specifications (DC)

Over Recommended DC Temperature ( $T_A = 0^\circ\text{C}$  to  $+70^\circ\text{C}$ ,  $V_{CC} = 5\text{ V}$ ,  $I_F = 16\text{ mA}$ ) unless otherwise specified. (See note 13.)

Parameter	Sym.	Device	Min.	Typ.*	Max.	Units	Test Conditions	Fig.	Note
Current Transfer Ratio	CTR	HCPL-050L HCPL-250L HCPL-053L HCPL-253L	19	24	50	%	$V_O = 0.4\text{ V}$ $T_A = 25^\circ\text{C}$ , $V_{CC} = 4.5\text{ V}$ , $I_F = 16\text{ mA}$	3	5, 11
Logic Low Output Voltage	$V_{OL}$	HCPL-050L HCPL-250L HCPL-053L HCPL-253L		0.1	0.4	V	$I_O = 3.0\text{ mA}$ $T_A = 25^\circ\text{C}$ , $I_F = 16\text{ mA}$ , $V_{CC} = 4.5\text{ V}$		
Logic High Output Current	$I_{OH}$			0	0.5	$\mu\text{A}$	$V_O = V_{CC} = 5.5\text{ V}$ $T_A = 25^\circ\text{C}$	5	
Logic Low Supply Current	$I_{CCL}$	HCPL-050L HCPL-250L HCPL-053L HCPL-253L		50	200	$\mu\text{A}$	$V_{CC} = 7\text{ V}$ $I_F = 16\text{ mA}$ $V_O = \text{Open}$		13
Logic High Supply Current	$I_{CCH}$	HCPL-050L HCPL-250L HCPL-053L HCPL-253L		0.02	1	$\mu\text{A}$	$T_A = 25^\circ\text{C}$ $I_F = 0\text{ mA}$ $V_O = \text{Open}$ $V_{CC} = 7\text{ V}$		13
Input Forward Voltage	$V_F$			1.5	1.7	V	$T_A = 25^\circ\text{C}$ $I_F = 16\text{ mA}$		1
Input Reverse Breakdown Voltage	$BV_R$		5			V	$I_R = 10\ \mu\text{A}$		
Input Capacitance	$C_{IN}$			60		pF	$f = 1\text{ MHz}$ , $V_F = 0$		

\*All typical values at  $T_A = 25^\circ\text{C}$



### Switching Specifications (AC)

Over Recommended Temperature ( $T_A = 0^\circ\text{C}$  to  $+70^\circ\text{C}$ ),  $V_{CC} = 3.3\text{ V}$ ,  $I_F = 16\text{ mA}$  unless otherwise specified.  
All typicals at  $V_{CC} = 3.3\text{ V}$ ,  $T_A = 25^\circ\text{C}$ .

Parameter	Sym.	Device	Min.	Typ.*	Max.	Units	Test Conditions	Fig.	Note
Propagation Delay Time to Logic Low at Output	$t_{PHL}$			0.35	1	$\mu\text{s}$	$R_L = 1.9\text{ k}\Omega$	7	8, 9
Propagation Delay Time to Logic High at Output	$t_{PLH}$			0.65	1	$\mu\text{s}$	$R_L = 1.9\text{ k}\Omega$	7	8, 9
Common Mode Transient Immunity at Logic High Level Output	$ CM_H $			1		$\text{kV}/\mu\text{s}$	$R_L = 4.1\text{ k}\Omega$ $R_L = 1.9\text{ k}\Omega$ $I_F = 0\text{ mA}$ , $T_A = 25^\circ\text{C}$ , $V_{CM} = 10\text{ V}_{p-p}$ $C_L = 15\text{ pF}$	8	7, 8, 9
Common Mode Transient Immunity at Logic Low Level Output	$ CM_L $			1		$\text{kV}/\mu\text{s}$	$R_L = 4.1\text{ k}\Omega$ $R_L = 1.9\text{ k}\Omega$ $I_F = 16\text{ mA}$ , $T_A = 25^\circ\text{C}$ , $V_{CM} = 10\text{ V}_{p-p}$ $C_L = 15\text{ pF}$	8	7, 8, 9

\*All typicals at  $T_A = 25^\circ\text{C}$

### Switching Specifications (AC)

Over Recommended Temperature ( $T_A = 0^\circ\text{C}$  to  $+70^\circ\text{C}$ ,  $V_{CC} = 5\text{ V}$ ,  $I_F = 16\text{ mA}$ , unless otherwise specified.

Parameter	Sym.	Device	Min.	Typ.*	Max.	Units	Test Conditions	Fig.	Note
Propagation Delay Time to Logic Low at Output	$t_{PHL}$			0.2	0.8	$\mu\text{s}$	$T_A = 25^\circ\text{C}$ , $R_L = 1.9\text{ k}\Omega$	7	8,9
Propagation Delay Time to Logic High at Output	$t_{PLH}$			0.6	0.8	$\mu\text{s}$	$T_A = 25^\circ\text{C}$ , $R_L = 1.9\text{ k}\Omega$	7	8,9
Common Mode Transient Immunity at Logic High Output	$ CM_H $			1		$\text{kV}/\mu\text{s}$	$R_L = 1.9\text{ k}\Omega$ $I_F = 0\text{ mA}$ , $T_A = 25^\circ\text{C}$ , $ V_{CM}  = 10\text{ V}_{p-p}$ $C_L = 15\text{ pF}$	8	7,8,9
Common Mode Transient Immunity at Logic Low Output	$ CM_L $			1		$\text{kV}/\mu\text{s}$	$R_L = 1.9\text{ k}\Omega$ $I_F = 16\text{ mA}$ , $T_A = 25^\circ\text{C}$ , $ V_{CM}  = 10\text{ V}_{p-p}$	8	7,8,9

\*All typical values at  $T_A = 25^\circ\text{C}$

## Package Characteristics

Over Recommended Temperature ( $T_A = 0^\circ\text{C}$  to  $70^\circ\text{C}$ ) unless otherwise specified.

Parameter	Sym.	Device	Min.	Typ.*	Max.	Units	Test Conditions	Fig.	Note
Input-Output Momentary Withstand Voltage**	$V_{ISO}$	8-Pin DIP SO-8	3750			V rms	RH < 50%, t = 1 min., $T_A = 25^\circ\text{C}$		6, 14
	$I_{I-O}$	8-Pin DIP			1	$\mu\text{A}$	45% RH, t = 5 s, $V_{I-O} = 3\text{ kVdc}$ , $T_A = 25^\circ\text{C}$		6, 16
Input-Output Resistance	$R_{I-O}$	8-Pin DIP SO-8		10 <sup>12</sup>		$\Omega$	$V_{I-O} = 500\text{ Vdc}$		6
Input-Output Capacitance	$C_{I-O}$	8-Pin DIP SO-8		0.6		pF	f = 1 MHz		6

\*All typicals at  $T_A = 25^\circ\text{C}$ .

\*\*The Input-Output Momentary Withstand Voltage is a dielectric voltage rating that should not be interpreted as an input-output continuous voltage rating. For the continuous voltage rating refer to the IEC/EN/DIN EN 60747-5-2 Insulation Related Characteristics Table (if applicable), your equipment level safety specification or Avago Application Note 1074 entitled "Optocoupler Input-Output Endurance Voltage," publication number 5963-2203E.

### Notes:

- Derate linearly above  $70^\circ\text{C}$  free-air temperature at a rate of  $0.8\text{ mA}/^\circ\text{C}$  (8-Pin DIP).  
Derate linearly above  $85^\circ\text{C}$  free-air temperature at a rate of  $0.5\text{ mA}/^\circ\text{C}$  (SO-8).
- Derate linearly above  $70^\circ\text{C}$  free-air temperature at a rate of  $1.6\text{ mA}/^\circ\text{C}$  (8-Pin DIP).  
Derate linearly above  $85^\circ\text{C}$  free-air temperature at a rate of  $1.0\text{ mA}/^\circ\text{C}$  (SO-8).
- Derate linearly above  $70^\circ\text{C}$  free-air temperature at a rate of  $0.9\text{ mW}/^\circ\text{C}$  (8-Pin DIP).  
Derate linearly above  $85^\circ\text{C}$  free-air temperature at a rate of  $1.1\text{ mW}/^\circ\text{C}$  (SO-8).
- Derate linearly above  $70^\circ\text{C}$  free-air temperature at a rate of  $2.0\text{ mW}/^\circ\text{C}$  (8-Pin DIP).  
Derate linearly above  $85^\circ\text{C}$  free-air temperature at a rate of  $2.3\text{ mW}/^\circ\text{C}$  (SO-8).
- CURRENT TRANSFER RATIO in percent is defined as the ratio of output collector current,  $I_O$ , to the forward LED input current,  $I_F$ , times 100.
- Device considered a two-terminal device: Pins 1, 2, 3, and 4 shorted together and Pins 5, 6, 7, and 8 shorted together.
- Common mode transient immunity in a Logic High level is the maximum tolerable (positive)  $dV_{CM}/dt$  on the leading edge of the common mode pulse signal,  $V_{CM}$ , to assure that the output will remain in a Logic High state (i.e.,  $V_O > 2.0\text{ V}$ ). Common mode transient immunity in a Logic Low level is the maximum tolerable (negative)  $dV_{CM}/dt$  on the trailing edge of the common mode pulse signal,  $V_{CM}$ , to assure that the output will remain in a Logic Low state (i.e.,  $V_O < 0.8\text{ V}$ ).
- The  $1.9\text{ k}\Omega$  load represents 1 TTL unit load of  $1.6\text{ mA}$  and the  $5.6\text{ mA k}\Omega$  pull-up resistor.
- The  $4.1\text{ k}\Omega$  load represents 1 LSTTL unit load of  $0.36\text{ mA}$  and  $6.1\text{ k}\Omega$  pull-up resistor.
- The frequency at which the AC output voltage is 3 dB below its mid-frequency value.
- The JEDEC registration for the 6N136 specifies a minimum CTR of 15%. Avago guarantees a minimum CTR of 15%.
- See Option 020 data sheet for more information.
- Use of a  $0.1\text{ }\mu\text{f}$  bypass capacitor connected between pins 5 and 8 is recommended.
- In accordance with UL 1577, each optocoupler is proof tested by applying an insulation test voltage  $\geq 4500\text{ V rms}$  for 1 second (leakage detection current limit,  $I_{I-O} \leq 5\text{ }\mu\text{A}$ ). This test is performed before the 100% Production test shown in the IEC/EN/DIN EN 60747-5-2 Insulation Related Characteristics Table, if applicable.
- In accordance with UL 1577, each optocoupler is proof tested by applying an insulation test voltage  $\geq 6000\text{ V rms}$  for 1 second (leakage detection current limit,  $I_{I-O} \leq 5\text{ }\mu\text{A}$ ). This test is performed before the 100% Production test shown in the IEC/EN/DIN EN 60747-5-2 Insulation Related Characteristics Table, if applicable.
- This rating is equally validated by an equivalent AC proof test.



Figure 1. Input current vs. forward voltage.

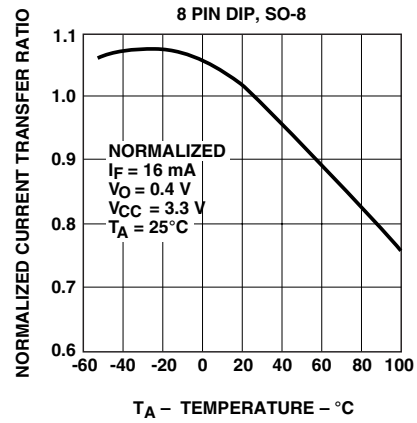

Figure 2. Current transfer ratio vs. temperature.

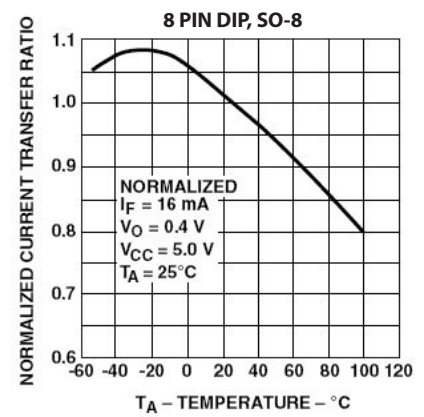

Figure 3. Current transfer ratio vs. temperature

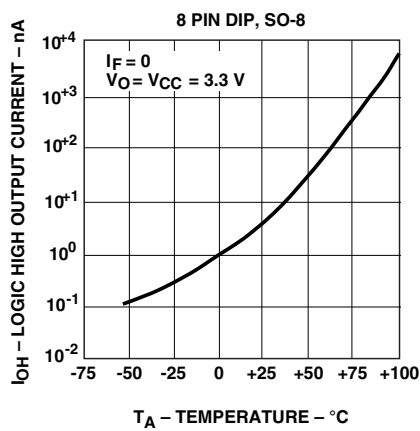

Figure 4. Logic high output current vs. temperature.

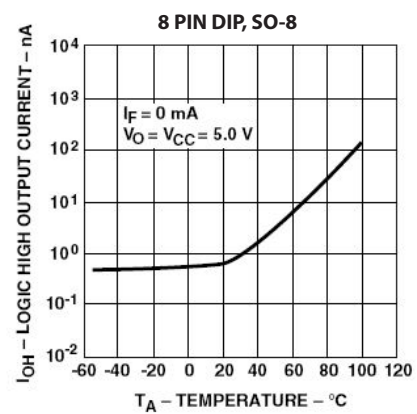

Figure 5. Logic high output current vs. temperature



Figure 6. Thermal derating curve, dependence of safety limiting value with case temperature per IEC/EN/DIN EN 60747-5-2.