

# HCPL-0370, HCPL-3700, HCPL-3760

## Isolated Voltage/Current Detectors

### Data Sheet



#### Description

The HCPL-0370/3700 and HCPL-3760 are voltage/current threshold detection optocouplers. The HCPL-3760 is a low-current version of the HCPL-0370/3700. To obtain lower current operation, the HCPL-3760 uses a high-efficiency AlGaAs LED which provides higher light output at lower drive currents. The devices utilize threshold sensing input buffer ICs which permit control of threshold levels over a wide range of input voltages with a single external resistor.

The input buffer incorporates several features: hysteresis for extra noise immunity and switching immunity, a diode bridge for easy use with ac input signals, and internal clamping diodes to protect the buffer and LED from a wide range of over-voltage and over-current transients. Because threshold sensing is done prior to driving the LED, variations in optical coupling from the LED to the detector will have no effect on the threshold levels.

#### Functional Diagram



TRUTH TABLE  
(POSITIVE LOGIC)

INPUT	OUTPUT
H	L
L	H

#### Features

- Standard (HCPL-0370/3700) and low input current (HCPL-3760) versions
- AC or DC input
- Programmable sense voltage
- Hysteresis
- Logic compatible output
- Thresholds guaranteed over temperature
- Thresholds independent of LED optical parameters
- Recognized under UL 1577 and CSA approved for dielectric withstand proof test voltage of 3750 Vac, 1 minute

#### Applications

- Limit switch sensing
- Low voltage detector
- AC mains and DC link voltage detection
- Relay contact monitor
- Relay coil voltage monitor
- Current sensing
- Microprocessor interfacing

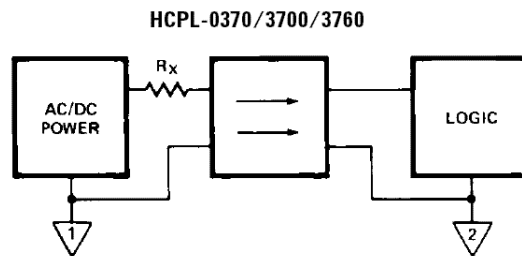

**CAUTION:** It is advised that normal static precautions be taken in handling and assembly of this component to prevent damage and/or degradation which may be induced by ESD.

The HCPL-0370/3700's input buffer IC has a nominal turn on threshold of 2.5 mA ( $I_{TH+}$ ) and 3.7 volts ( $V_{TH+}$ ).

The buffer IC for the HCPL-3760 was redesigned to permit a lower input current. The nominal turn on threshold for the HCPL-3760 is 1.2 mA ( $I_{TH+}$ ) and 3.7 volts ( $V_{TH+}$ ).

The high gain output stage features an open collector output providing both TTL compatible saturation voltages and CMOS compatible breakdown voltages.

By combining several unique functions in a single package, the user is provided with an ideal component for industrial control computer input boards and other applications where a predetermined input threshold level is desirable.

## Ordering Information

HCPL-0370/HCPL-3700/HCPL-3760 is UL Recognized with 3750 Vrms for 1 minute per UL1577 unless otherwise specified.

Part number	Option		Package	Surface Mount	Gull Wing	Tape & Reel	UL 5000 Vrms/1 Minute	IEC/EN/DIN EN 60747-5-5	Quantity	
	RoHS Compliant	Non-RoHS Compliant								
HCPL-0370	-000E	No option	SO-8	X					100 per tube	
	-500E	-500		X		X			1500 per reel	
	-060E	NA		X				X	100 per tube	
	-560E	NA		X		X		X	1500 per reel	
HCPL-3700	-000E	No option	300 mil DIP-8						50 per tube	
	-300E	#300		X	X				50 per tube	
	-500E	#500		X	X	X			1000 per reel	
	-020E	-020						X	50 per tube	
	-320E	-320		X	X			X	50 per tube	
	-520E	-520		X	X	X	X		1000 per reel	
	-060E	NA							X	50 per tube
	-360E	NA		X	X				X	50 per tube
HCPL-3760	-560E	NA	X	X	X			X	1000 per reel	
	-000E	No option	300 mil DIP-8						50 per tube	
	-300E	#300		X	X				50 per tube	
	-500E	#500		X	X	X			1000 per reel	
	-060E	NA							X	50 per tube
	-360E	NA		X	X				X	50 per tube
-560E	NA	X		X	X			X	1000 per reel	

Note:  
NA = Not available.

To order, choose a part number from the part number column and combine with the desired option from the option column to form an order entry.

Example 1: HCPL-3760-500E to order product of Gull Wing Surface Mount package in Tape and Reel packaging with and RoHS compliant.

Example 2: HCPL-3700 to order product of 300 mil DIP package in Tube packaging and non RoHS compliant.

Option datasheets are available. Contact your Avago sales representative or authorized distributor for information.

Remarks: The notation '#XXX' is used for existing products, while (new) products launched since July 15, 2001 and RoHS compliant will use '-XXE.'

**Schematic**

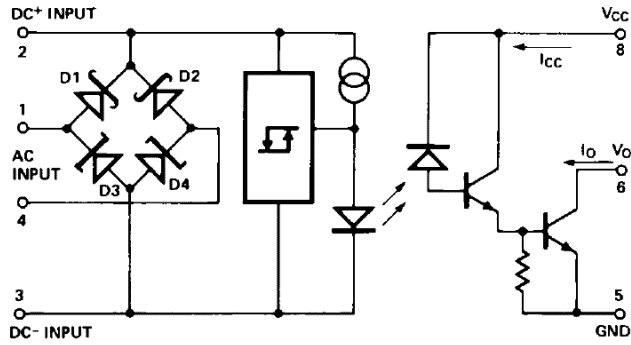

**Package Outline Drawings**

**Standard DIP Package (HCPL-3700/3760)**

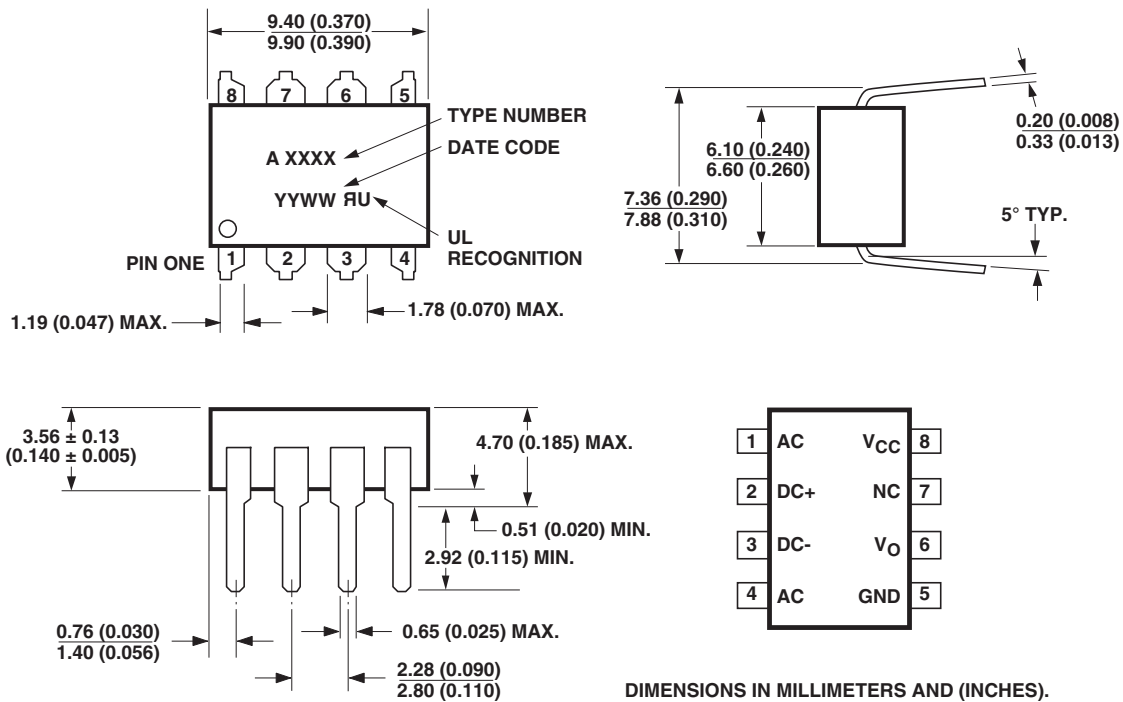

DIMENSIONS IN MILLIMETERS AND (INCHES).

NOTE: FLOATING LEAD PROTRUSION IS 0.25 mm (10 mils) MAX.

**Package Outline Drawings, continued**  
**Gull Wing Surface Mount Option 300 (HCPL-3700/3760)**



DIMENSIONS IN MILLIMETERS (INCHES).  
 TOLERANCES (UNLESS OTHERWISE SPECIFIED): xx.xx = 0.01  
 xx.xxx = 0.005

LEAD COPLANARITY  
 MAXIMUM: 0.102 (0.004)

NOTE: FLOATING LEAD PROTRUSION IS 0.25 mm (10 mils) MAX.

**Small Outline S0-8 Package (HCPL-0370)**



\* TOTAL PACKAGE LENGTH (INCLUSIVE OF MOLD FLASH)  
 5.207 ± 0.254 (0.205 ± 0.010)

DIMENSIONS IN MILLIMETERS (INCHES).  
 LEAD COPLANARITY = 0.10 mm (0.004 INCHES) MAX.

NOTE: FLOATING LEAD PROTRUSION IS 0.15 mm (6 mils) MAX.

## Solder Reflow Thermal Profile



Note: Non-halide flux should be used.

## Recommended Pb-Free IR Profile



NOTES:  
 THE TIME FROM 25 °C to PEAK TEMPERATURE = 8 MINUTES MAX.  
 $T_{smax} = 200\text{ }^\circ\text{C}$ ,  $T_{smin} = 150\text{ }^\circ\text{C}$

Note: Non-halide flux should be used.

## Regulatory Information

The HCPL-0370/3700/3760 has been approved by the following organizations:

### IEC/EN/DIN EN 60747-5-5 (with option 060)

Maximum Working Insulation Voltage  $V_{IORM} = 567\text{ Vpeak}$  for HCPL-0370, and  $630\text{ Vpeak}$  for HCPL3700/3760.

Highest Allowable Overvoltage  $V_{IOTM} = 6000\text{ Vpeak}$  for HCPL-0370/3700/3760.

### UL

Recognized under UL 1577, component recognition program, File E55361 (HCPL-0370 pending).

### CSA

Approved under CSA Component Acceptance Notice #5, File CA 88324.

## Insulation and Safety Related Specifications

Parameter	Symbol	8-Pin DIP (300 mil)	SO-8	Units	Conditions
		Value	Value		
Min.. External Air Gap (External Clearance)	L(IO1)	7.1	4.9	mm	Measured from input terminals to output terminals, hortest distance through air
Min.. External Tracking Path (External Creepage)	L(IO2)	7.4	4.8	mm	Measured from input terminals to output terminals, shortest distance path along body
Min.. Internal Plastic Gap (Internal Clearance)		0.08	0.08	mm	Through insulation distance, conductor to conductor, usually the direct distance between the photoemitter and photodetector inside the optocoupler cavity
Tracking Resistance (Comparative Tracking Index)	CTI	200	200	V	DIN IEC 112/VDE 0303 PART 1
Isolation Group			IIIa		Material Group (DIN VDE 0110, 1/89, Table 1)

## IEC/EN/DIN EN 60747-5-5 Insulation Related Characteristics<sup>[1]</sup> (with option 060)

Description	Symbol	HCPL-0370	HCPL-3700/3760	Units
Installation classification per DIN VDE 0110/1.89, Table 1 for rated mains voltage $\leq 150$ V rms for rated mains voltage $\leq 300$ V rms for rated mains voltage $\leq 600$ V rms		I-IV I-IV I-III	I-IV I-IV I-III	
Climatic Classification		55/85/21	55/85/21	
Pollution Degree (DIN VDE 0110/1.89)		2	2	
Maximum Working Insulation Voltage	$V_{IORM}$	567	630	V peak
Input to Output Test Voltage, Method b $V_{IORM} \times 1.875 = V_{PR}$ 100% Production Test with $t_m = 1$ sec Partial Discharge $< 5$ pC	$V_{PR}$	1063	1181	V peak
Input to Output Test Voltage, Method a $V_{IORM} \times 1.6 = V_{PR}$ Type and sample test, $t_m = 10$ sec, Partial Discharge $< 5$ pC	$V_{PR}$	907	1008	V peak
Highest Allowable Overvoltage (Transient Overvoltage, $t_{ini} = 60$ sec)	$V_{IOTM}$	6000	6000	V peak
Safety Limiting Values (Maximum values allowed in the event of a failure)				
Case Temperature	$T_s$	150	175	°C
Input Current [2]	$I_{S,INPUT}$	150	230	mA
Output Power [2]	$P_{S,OUTPUT}$	600	600	mW
Insulation Resistance at $T_s, V_{IO} = 500$ V	$R_s$	109	109	$\Omega$

### Notes:

- Insulation characteristics are guaranteed only within the safety maximum ratings, which must be ensured by protective circuits within the application.
- Safety-limiting parameters are dependent on case temperature. The Input Current,  $I_{S,INPUT}$  derates linearly above 25°C free-air case temperature at a rate of 1.2 mA/°C and 1.53 mA/°C for HCPL-0370 and HCPL-3700/3760 respectively; the Output Power,  $P_{S,OUTPUT}$  derates linearly above 25°C free-air case temperature at a rate of 4.8 mW/°C and 4 mW/°C for HCPL-0370 and HCPL-3700/3760 respectively.

**Absolute Maximum Ratings (No derating required up to 70°C)**

Parameter	Symbol	Min.	Max.	Units	Note
Storage Temperature	$T_S$	-55	125	°C	
Operating Temperature	$T_A$	-40	85	°C	
Lead Soldering Cycle	Temperature		260	°C	1
	Time		10	s	
Input Current	Average		50		2
	Surge	$I_{IN}$	140	mA	2, 3
	Transient		500		
Input Voltage (Pins 2-3)	$V_{IN}$	-0.5		V	
Input Power Dissipation	HCPL-3700/3760	$P_{IN}$	230	mW	4
	HCPL-0370		172		
Total Package Power Dissipation	HCPL-3700/3760	$P_T$	305	mW	5
	HCPL-0370		275		
Output Power Dissipation	HCPL-3700/3760	$P_O$	210	mW	6
	HCPL-0370		103		
Output Current	Average	$I_O$	30	mA	7
Supply Voltage (Pins 8-5)	$V_{CC}$	-0.5	20	V	
Output Voltage (Pins 6-5)	$V_O$	-0.5	20	V	
Solder Reflow Temperature Profile	See Package Outline Drawings section				

**Recommended Operating Conditions**

Parameter	Symbol	Min.	Max.	Units	Note
Supply Voltage	$V_{CC}$	2	18	V	
Operating Temperature	$T_A$	0	70	°C	
Operating Frequency	f	0	4	kHz	8

## Electrical Specifications

Over Recommended Temperature  $T_A = 0^\circ\text{C}$  to  $70^\circ\text{C}$ , Unless Otherwise Specified.

Parameter	Sym.	Device	Min.	Typ. <sup>[9]</sup>	Max.	Units	Conditions	Fig.	Note		
Input Threshold Current	$I_{TH+}$	HCPL-0370/3700	1.96	2.5	3.11	mA	$V_{IN} = V_{TH+}; V_{CC} = 4.5\text{ V}; V_O = 0.4\text{ V}; I_O \geq 4.2\text{ mA}$	2, 3	14		
		HCPL-3760	0.87	1.2	1.56						
	$I_{TH-}$	HCPL-0370/3700	1.00	1.3	1.62		$V_{IN} = V_{TH-}; V_{CC} = 4.5\text{ V}; V_O = 2.4\text{ V}; I_{OH} \leq 100\text{ }\mu\text{A}$				
		HCPL-3760	0.43	0.6	0.80						
Input Threshold Voltage	DC (Pins 2, 3)	$V_{TH+}$	3.35	3.7	4.05	V	$V_{IN} = V_2 - V_3$ ; Pins 1 & 4 Open $V_{CC} = 4.5\text{ V}; V_O = 0.4\text{ V}; I_O \geq 4.2\text{ mA}$				
			$V_{TH-}$	2.01	2.6					2.86	$V_{IN} = V_2 - V_3$ ; Pins 1 & 4 Open $V_{CC} = 4.5\text{ V}; V_O = 2.4\text{ V}; I_O \leq 100\text{ }\mu\text{A}$
	AC (Pins 1, 4)	$V_{TH+}$	4.23	4.9	5.50	V	$V_{IN} =  V_1 - V_4 $ ; Pins 2 & 3 Open $V_{CC} = 4.5\text{ V}; V_O = 0.4\text{ V}; I_O \geq 4.2\text{ mA}$		14, 15		
			$V_{TH-}$	2.87	3.7					4.20	$V_{IN} =  V_1 - V_4 $ ; Pins 2 & 3 Open $V_{CC} = 4.5\text{ V}; V_O = 2.4\text{ V}; I_O \leq 100\text{ }\mu\text{A}$
Hysteresis	$I_{HYS}$	HCPL-0370/3700		1.2		mA	$I_{HYS} = I_{TH+} - I_{TH-}$	2			
		HCPL-3760		0.6							
	$V_{HYS}$			1.2		V	$V_{HYS} = V_{TH+} - V_{TH-}$				
Input Clamp Voltage	$V_{IHC1}$		5.4	6.0	6.6	V	$V_{IHC1} = V_2 - V_3; V_3 = \text{GND}; I_{IN} = 10\text{ mA};$ Pins 1 & 4 Connected to Pin 3	1			
			$V_{IHC2}$	6.1	6.7					7.3	$V_{IHC2} =  V_1 - V_4 $ ; $ I_{IN}  = 10\text{ mA};$ Pins 2 & 3 Open
			$V_{IHC3}$		12.0					13.4	$V_{IHC3} = V_2 - V_3; V_3 = \text{GND}; I_{IN} = 15\text{ mA};$ Pins 1 & 4 Open
			$V_{ILC}$		-0.76						$V_{ILC} = V_2 - V_3; V_3 = \text{GND}; I_{IN} = -10\text{ mA}$
Input Current	$I_{IN}$	HCPL-0370/3700	3.0	3.7	4.4	mA	$V_{IN} = V_2 - V_3 = 5.0\text{ V}$ Pins 1 & 4 Open	5			
		HCPL-3760	1.5	1.8	2.2						
Bridge Diode Forward Voltage	$V_{D1,2}$	HCPL-0370/3700		0.59		V	$I_{IN} = 3\text{ mA}$				
		HCPL-3760		0.51						$I_{IN} = 1.5\text{ mA}$	
	$V_{D3,4}$	HCPL-0370/3700		0.74			$I_{IN} = 3\text{ mA}$				
		HCPL-3760		0.71						$I_{IN} = 1.5\text{ mA}$	
Logic Low Output Voltage	$V_{OL}$			0.1	0.4	V	$V_{CC} = 4.5\text{ V}; I_{OL} = 4.2\text{ mA}$	5	14		
Logic High Output Current	$I_{OH}$				100	$\mu\text{A}$	$V_{OH} = V_{CC} = 18\text{ V}$		14		
Logic Low Supply Current	$I_{CCL}$	HCPL-0370/3700		1.2	4	mA	$V_2 - V_3 = 5.0\text{ V}; V_O = \text{Open}; V_{CC} = 5.0\text{ V}$	6			
		HCPL-3760		0.7	3						
Logic High Supply Current	$I_{CCH}$			0.002	4	$\mu\text{A}$	$V_{CC} = 18\text{ V}; V_O = \text{Open}$	4	14		
Input Capacitance	$C_{IN}$			50		pF	$f = 1\text{ MHz}; V_{IN} = 0\text{ V},$ Pins 2 & 3, Pins 1 & 4 Open				



## Switching Specifications

$T_A = 25^\circ\text{C}$ ,  $V_{CC} = 5.0\text{ V}$ , Unless Otherwise Specified.

Parameter	Sym.	Device	Min.	Typ.	Max.	Units	Test Conditions	Fig.	Note
Propagation Delay Time to Logic Low at Output	$t_{PHL}$	HCPL-0370/3700		4.0	15.0	$\mu\text{s}$	$R_L = 4.7\text{ k}\Omega$ , $C_L = 30\text{ pF}$	7, 10	
		HCPL-3760		4.5					
Propagation Delay Time to Logic High at Output	$t_{PLH}$	HCPL-0370/3700		10.0	40.0	$\mu\text{s}$	$R_L = 4.7\text{ k}\Omega$ , $C_L = 30\text{ pF}$		11
		HCPL-3760		8.0					
Output Rise Time (10-90%)	$t_r$	HCPL-0370/3700		20		$\mu\text{s}$	$R_L = 4.7\text{ k}\Omega$ , $C_L = 30\text{ pF}$	8	
		HCPL-3760		14					
Output Fall Time (90-10%)	$t_f$	HCPL-0370/3700		0.3		$\mu\text{s}$	$R_L = 4.7\text{ k}\Omega$ , $C_L = 30\text{ pF}$		
		HCPL-3760		0.4					
Common Mode Transient Immunity at Logic High Output	$ CM_H $			4000		$\text{V}/\mu\text{s}$	$I_{IN} = 0\text{ mA}$ , $R_L = 4.7\text{ k}\Omega$ , $V_{Omin} = 2.0\text{ V}$ , $V_{CM} = 1400\text{ V}$	9, 11	12, 13
Common Mode Transient Immunity at Logic Low Output	$ CM_L $	HCPL-0370/3700		600		$\text{V}/\mu\text{s}$	$I_{IN} = 3.11\text{ mA}$ $R_L = 4.7\text{ k}\Omega$ , $I_{IN} = 1.56\text{ mA}$ $V_{Omax} = 0.8\text{ V}$ , $V_{CM} = 140\text{ V}$		

## Package Characteristics

Over Recommended Temperature  $T_A = 0^\circ\text{C}$  to  $70^\circ\text{C}$ , Unless Otherwise Specified.

Parameter	Sym.	Min.	Typ. <sup>[9]</sup>	Max.	Units	Conditions	Fig.	Note
Input-Output Momentary Withstand Voltage*	$V_{ISO}$	3750			$\text{V rms}$	RH 50%, $t = 1\text{ min}$ ; $T_A = 25^\circ\text{C}$		16,
								17
		Option 020	5000					
Input-Output Resistance	$R_{I-O}$		$10^{12}$		$\Omega$	$V_{I-O} = 500\text{ Vdc}$		16
Input-Output Capacitance	$C_{I-O}$		0.6		$\text{pF}$	$f = 1\text{ MHz}$ ; $V_{I-O} = 0\text{ Vdc}$		

\*The Input-Output Momentary Withstand Voltage is a dielectric voltage rating that should not be interpreted as an input-output continuous voltage rating. For the continuous voltage rating refer to the IEC/EN/DIN EN 60747-5-5 Insulation Characteristics Table (if applicable), your equipment level safety specification, or Avago Application Note 1074, "Optocoupler Input-Output Endurance Voltage."

**Notes:**

1. Measured at a point 1.6 mm below seating plane.
2. Current into/out of any single lead.
3. Surge input current duration is 3 ms at 120 Hz pulse repetition rate. Transient input current duration is 10  $\mu$ s at 120 Hz pulse repetition rate. Note that maximum input power,  $P_{IN}$ , must be observed.
4. Derate linearly above 70°C free-air temperature at a rate of 4.1 mW/°C (HCPL-3700/3760) and 3.1 mW/°C (HCPL-0370). Maximum input power dissipation of 230 mW (HCPL-3700/3760) and 172 mW (HCPL-0370) allows an input IC junction temperature of 125°C at an ambient temperature of  $T_A = 70^\circ\text{C}$ . Excessive  $P_{IN}$  and  $T_J$  may result in IC chip degradation.
5. Derate linearly above 70°C free-air temperature at a rate of 5.4 mW/°C (HCPL-3700/3760) and 5 mW/°C (HCPL-0370).
6. Derate linearly above 70°C free-air temperature at a rate of 3.9 mW/°C (HCPL-3700/3760) and 1.9 mW/°C (HCPL-0370). Maximum output power dissipation of 210 mW (HCPL-3700/3760) and 103 mW (HCPL-0370) allows an output IC junction temperature of 125°C at an ambient temperature of  $T_A = 70^\circ\text{C}$ .
7. Derate linearly above 70°C free-air temperature at a rate of 0.6 mA/°C.
8. Maximum operating frequency is defined when output waveform Pin 6 obtains only 90% of  $V_{CC}$  with  $R_L = 4.7\text{ k}\Omega$ ,  $C_L = 30\text{ pF}$  using a 5 V square wave input signal.
9. All typical values are at  $T_A = 25^\circ\text{C}$ ,  $V_{CC} = 5.0\text{ V}$  unless otherwise stated.
10. The  $t_{PHL}$  propagation delay is measured from the 2.5 V level of the leading edge of a 5.0 V input pulse (1  $\mu$ s rise time) to the 1.5 V level on the leading edge of the output pulse (see Figure 10).
11. The  $t_{PLH}$  propagation delay is measured from the 2.5 V level of the trailing edge of a 5.0 V input pulse (1  $\mu$ s fall time) to the 1.5 V level on the trailing edge of the output pulse (see Figure 10).
12. Common mode transient immunity in Logic High level is the maximum tolerable (positive)  $dV_{CM}/dt$  on the leading edge of the common mode pulse,  $V_{CM}$ , to insure that the output will remain in a Logic High state (i.e.,  $V_O > 2.0\text{ V}$ ). Common mode transient immunity in Logic Low level is the maximum tolerable (negative)  $dV_{CM}/dt$  on the trailing edge of the common mode pulse signal,  $V_{CM}$ , to insure that the output will remain in a Logic Low state (i.e.,  $V_O < 0.8\text{ V}$ ). See Figure 11.
13. In applications where  $dV_{CM}/dt$  may exceed 50,000 V/ $\mu$ s (such as static discharge), a series resistor,  $R_{CC}$ , should be included to protect the detector IC from destructively high surge currents. The recommended value for  $R_{CC}$  is 240  $\Omega$  per volt of allowable drop in  $V_{CC}$  (between Pin 8 and  $V_{CC}$ ) with a minimum value of 240  $\Omega$ .
14. Logic low output level at Pin 6 occurs under the conditions of  $V_{IN} \geq V_{TH+}$ , as well as the range of  $V_{IN} > V_{TH-}$ , once  $V_{IN}$  has exceeded  $V_{TH+}$ . Logic high output level at Pin 6 occurs under the conditions of  $V_{IN} < V_{TH-}$ , as well as the range of  $V_{IN} < V_{TH+}$ , once  $V_{IN}$  has decreased below  $V_{TH-}$ .
15. AC voltage is instantaneous voltage.
16. Device considered a two terminal device: Pins 1, 2, 3, 4 connected together, and Pins 5, 6, 7, 8 connected together.
17. In accordance with UL 1577, each optocoupler is proof tested by applying an insulation test voltage  $\geq 4500\text{ V rms}$  for 1 second (leakage detection current limit,  $I_{FO} \leq 5\text{ }\mu\text{A}$ ).
18. In accordance with UL 1577, each optocoupler is proof tested by applying an insulation test voltage  $\geq 6000\text{ V rms}$  for 1 second (leakage detection current limit,  $I_{FO} \leq 5\text{ }\mu\text{A}$ ). This test is performed before the 100% production test for partial discharge (Method b) shown in the IEC/EN/DIN EN 60747-5-5 Insulation Characteristics Table.



**Figure 1. Typical input characteristics,  $I_{IN}$  vs.  $V_{IN}$  (AC voltage is instantaneous value).**

Input Signal	Device	TH+	TH-	Input Connection
$I_{TH}$	HCPL-0370/3700	2.5 mA	1.3 mA	PINS 2, 3 OR 1, 4
	HCPL-3760	1.2 mA	0.6 mA	
$V_{TH(DC)}$	ALL	3.7 V	2.6 V	PINS 2, 3
$V_{TH(AC)}$	ALL	4.9 V	3.7 V	PINS 1, 4

**Figure 2. Typical transfer characteristics.**



Figure 3. Typical DC threshold levels vs. temperature.



Figure 4. Typical high level supply current,  $I_{CCH}$ , vs. temperature.



Figure 5. Typical input current,  $I_{IN}$ , and low level output voltage,  $V_{OL}$ , vs. temperature.

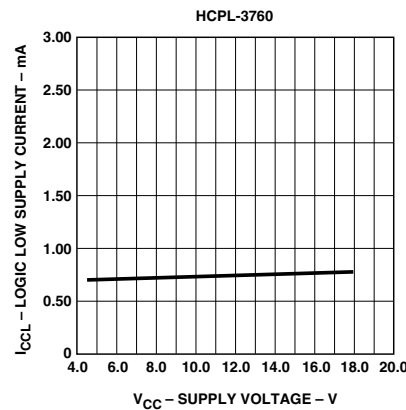
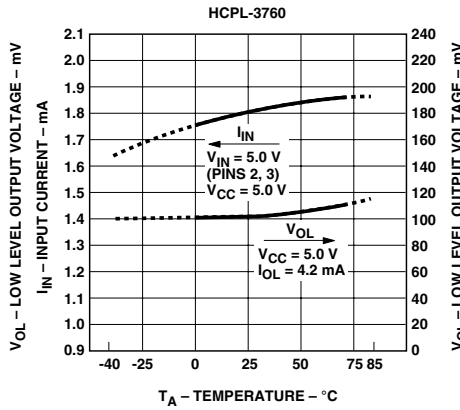

Figure 6. Typical logic low supply current vs. supply voltage.

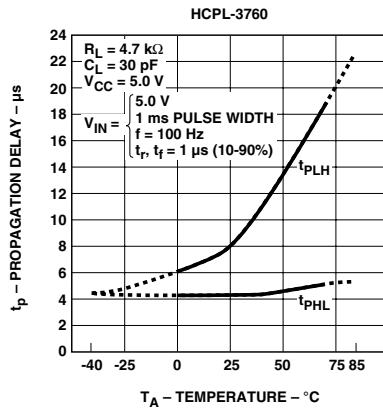

Figure 7. Typical propagation delay vs. temperature.



Figure 8. Typical rise, fall times vs. temperature.



Figure 9. Common mode transient immunity vs. common mode transient amplitude.



Figure 10. Switching test circuit.

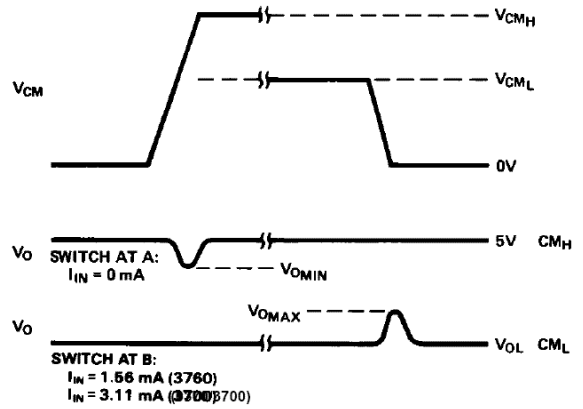

Figure 11. Test circuit for common mode transient immunity and typical waveforms.



Figure 12. Typical external threshold characteristics,  $V_{\pm}$  vs.  $R_X$ .