

8-Pin DIP High-Speed 10 MBit/s Logic Gate Optocouplers



ON Semiconductor®

www.onsemi.com

Single-Channel: 6N137M, HCPL2601M, HCPL2611M Dual-Channel: HCPL2630M, HCPL2631M

Description

The 6N137M, HCPL2601M, HCPL2611M single-channel and HCPL2630M, HCPL2631M dual-channel optocouplers consist of a 850 nm AlGaAs LED, optically coupled to a very high speed integrated photo-detector logic gate with a strobable output. This output features an open collector, thereby permitting wired OR outputs. The switching parameters are guaranteed over the temperature range of -40°C to $+85^{\circ}\text{C}$. A maximum input signal of 5 mA will provide a minimum output sink current of 13 mA (fan out of 8).

An internal noise shield provides superior common mode rejection of typically 10 kV/ μs . The HCPL2601M and HCPL2631M has a minimum CMR of 5 kV/ μs . The HCPL2611M has a minimum CMR of 10 kV/ μs .

Features

- Very High Speed – 10 MBit/s
- Superior CMR – 10 kV/ μs
- Fan-out of 8 Over -40°C to $+85^{\circ}\text{C}$
- Logic Gate Output
- Storable Output
- Wired OR–open Collector
- Safety and Regulatory Approvals
 - ◆ UL1577, 5,000 VAC_{RMS} for 1 Minute
 - ◆ DIN EN/IEC60747–5–5
- These are Pb–Free Devices

Applications

- Ground Loop Elimination
- LSTTL to TTL, LSTTL or 5 V CMOS
- Line Receiver, Data Transmission
- Data Multiplexing
- Switching Power Supplies
- Pulse Transformer Replacement
- Computer–peripheral Interface

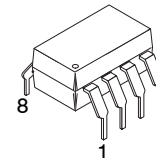

PDIP8 6.6x3.81, 2.54P
CASE 646BW

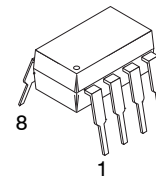

PDIP8 9.655x6.6, 2.54P
CASE 646CQ

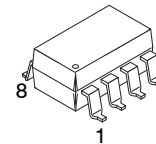

PDIP8 GW
CASE 709AC

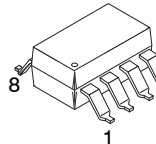

PDIP8 GW
CASE 709AD

MARKING DIAGRAM

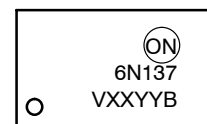

- 6N137 = Device Number
- V = DIN EN/IEC60747–5–5 Option (only appears on component ordered with this option)
- XX = Two-Digit Year Code, e.g., '16'
- YY = Two-Digit Work Week, Ranging from '01' to '53'
- B = Assembly Package Code

ORDERING INFORMATION

See detailed ordering and shipping information on page 14 of this data sheet.

Single-Channel: 6N137M, HCPL2601M, HCPL2611M Dual-Channel: HCPL2630M, HCPL2631M

SCHEMATICS

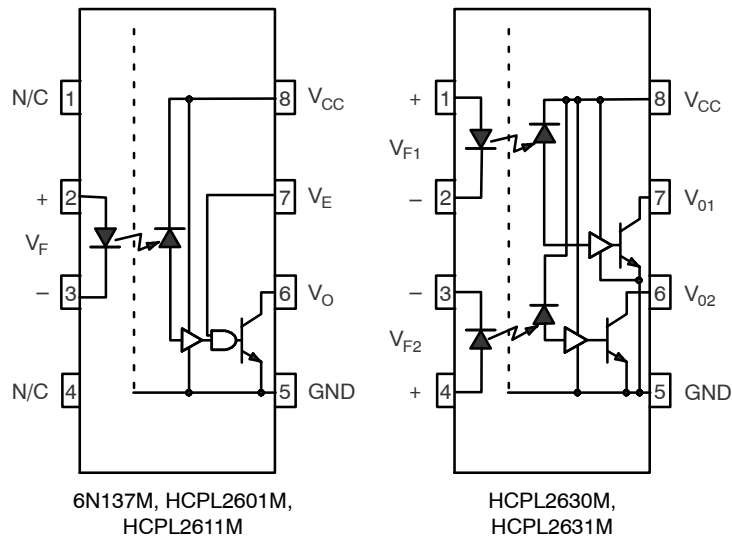

A 0.1 μ F bypass capacitor must be connected between pins 8 and 5 (Note 1).

Figure 1. Schematics

TRUTH TABLE (Positive Logic)

Input	Enable	Output
H	H	L
L	H	H
H	L	H
L	L	H
H	NC	L
L	NC	H

Single-Channel: 6N137M, HCPL2601M, HCPL2611M Dual-Channel: HCPL2630M, HCPL2631M

SAFETY AND INSULATION RATINGS (As per DIN EN/IEC 60747-5-5, this optocoupler is suitable for “safe electrical insulation” only within the safety limit data. Compliance with the safety ratings shall be ensured by means of protective circuits.)

Parameter		Characteristics
Installation Classifications per DIN VDE 0110/1.89 Table 1, For Rated Mains Voltage	<150 V _{RMS}	I-IV
	<300 V _{RMS}	I-IV
	<450 V _{RMS}	I-III
	<600 V _{RMS}	I-III
Climatic Classification		40/100/21
Pollution Degree (DIN VDE 0110/1.89)		2
Comparative Tracking Index		175

Symbol	Parameter	Value	Unit
V _{PR}	Input-to-Output Test Voltage, Method A, V _{IORM} × 1.6 = V _{PR} , Type and Sample Test with t _m = 10 s, Partial Discharge < 5 pC	1,335	V _{peak}
	Input-to-Output Test Voltage, Method B, V _{IORM} × 1.875 = V _{PR} , 100% Production Test with t _m = 1 s, Partial Discharge < 5 pC	1,669	V _{peak}
V _{IORM}	Maximum Working Insulation Voltage	890	V _{peak}
V _{IOTM}	Highest Allowable Over-Voltage	6,000	V _{peak}
	External Creepage	≥8.0	mm
	External Clearance	≥7.4	mm
	External Clearance (for Option TV, 0.4" Lead Spacing)	≥10.16	mm
DTI	Distance Through Insulation (Insulation Thickness)	≥0.5	mm
T _S	Case Temperature (Note 2)	150	°C
I _{S,INPUT}	Input Current (Note 2)	200	mA
P _{S,OUTPUT}	Output Power (Duty Factor ≤ 2.7%) (Note 2)	300	mW
R _{IO}	Insulation Resistance at T _S , V _{IO} = 500 V (Note 2)	>10 ⁹	Ω

1. The V_{CC} supply to each optoisolator must be bypassed by a 0.1 μF capacitor or larger. This can be either a ceramic or solid tantalum capacitor with good high frequency characteristic and should be connected as close as possible to the package V_{CC} and GND pins of each device.
2. Safety limit value – maximum values allowed in the event of a failure.

Single-Channel: 6N137M, HCPL2601M, HCPL2611M Dual-Channel: HCPL2630M, HCPL2631M

ABSOLUTE MAXIMUM RATINGS (T_A = 25°C unless otherwise noted)

Symbol	Parameter	Device	Value	Unit
T _{STG}	Storage Temperature		-40 to +125	°C
T _{OPR}	Operating Temperature		-40 to +100	°C
T _J	Junction Temperature		-40 to +125	°C
T _{SOL}	Lead Solder Temperature		260 for 10 s	°C

EMITTER

I _F (avg)	DC/Average Forward Input Current Per Channel	Single Channel	50	mA
		Dual Channel	30	
V _E	Enable Input Voltage Not to Exceed V _{CC} by More than 500 mV	Single Channel	5.5	V
V _R	Reverse Input Voltage Per Channel	All	5.0	V
P _I	Input Power Dissipation Per Channel	Single Channel	100	mW
		Dual Channel	45	

DETECTOR

V _{CC}	Supply Voltage	All	-0.5 to 7.0	V
I _O (avg)	Average Output Current Per Channel	All	25	mA
I _O (pk)	Peak Output Current Per Channel	All	50	mA
V _O	Output Voltage Per Channel	All	-0.5 to 7.0	V
P _O	Output Power Dissipation Per Channel	Single Channel	85	mW
		Dual Channel	60	

Stresses exceeding those listed in the Maximum Ratings table may damage the device. If any of these limits are exceeded, device functionality should not be assumed, damage may occur and reliability may be affected.

RECOMMENDED OPERATING CONDITIONS

Symbol	Parameter	Min	Max	Unit
V _{CC}	Supply Voltage	4.5	5.5	V
I _{FL}	Input Current, Low Level	0	250	μA
I _{FH}	Input Current, High Level	6.3 (Note 3)	20.0	mA
V _{EL}	Enable Voltage, Low Level	0	0.8	V
V _{EH}	Enable Voltage, High Level	2.0	V _{CC}	V
T _A	Ambient Operating Temperature	-40	+85	°C
N	Fan Out (TTL Load)	-	8	

Functional operation above the stresses listed in the Recommended Operating Ranges is not implied. Extended exposure to stresses beyond the Recommended Operating Ranges limits may affect device reliability.

3. 6.3 mA is a guard banded value which allows for at least 20% CTR degradation. Initial input current threshold value is 5.0 mA or less.

Single-Channel: 6N137M, HCPL2601M, HCPL2611M Dual-Channel: HCPL2630M, HCPL2631M

ELECTRICAL CHARACTERISTICS

Symbol	Parameter	Test Conditions	Device	Min	Typ	Max	Unit
--------	-----------	-----------------	--------	-----	-----	-----	------

INDIVIDUAL COMPONENT CHARACTERISTICS ($V_{CC} = 5.5\text{ V}$, $T_A = 0^\circ\text{C}$ to 70°C unless otherwise specified)

EMITTER							
V_F	Input Forward Voltage	$I_F = 10\text{ mA}$, $T_A = 25^\circ\text{C}$	All	-	1.45	1.70	V
		$I_F = 10\text{ mA}$		-	-	1.80	
B_{VR}	Input Reverse Breakdown Voltage	$I_R = 10\ \mu\text{A}$	All	5.0	-	-	V
C_{IN}	Input Capacitance	$V_F = 0$, $f = 1\text{ MHz}$	All	-	60	-	pF
$\Delta V_F / \Delta T_A$	Temperature Coefficient of Forward Voltage	$I_F = 10\text{ mA}$	All	-	-1.4	-	mV/ $^\circ\text{C}$
DETECTOR							
I_{OCL}	Logic Low Supply Current	$I_F = 10\text{ mA}$, $V_O = \text{Open}$, $V_E = 0.5\text{ V}$	Single Channel	-	8	13	mA
		$I_{F1} = I_{F2} = 10\text{ mA}$, $V_O = \text{Open}$	Dual Channel	-	14	21	
I_{OCH}	Logic High Supply Current	$I_F = 0\text{ mA}$, $V_O = \text{Open}$, $V_E = 0.5\text{ V}$	Single Channel	-	6	10	mA
		$I_F = 0\text{ mA}$, $V_O = \text{Open}$	Dual Channel	-	10	15	
I_{EL}	Low Level Enable Current	$V_E = 0.5\text{ V}$	Single Channel	-	-0.7	-1.6	mA
I_{EH}	High Level Enable Current	$V_E = 2.0\text{ V}$	Single Channel	-	-0.5	-1.6	mA
V_{EL}	Low Level Enable Voltage	$I_F = 10\text{ mA}$ (Note 4)	Single Channel	-	-	0.8	V
V_{EH}	High Level Enable Voltage	$I_F = 10\text{ mA}$	Single Channel	2.0	-	-	V

TRANSFER CHARACTERISTICS ($V_{CC} = 5.5\text{ V}$, $T_A = -40^\circ\text{C}$ to $+85^\circ\text{C}$ unless otherwise specified)

I_{FT}	Input Threshold Current	$V_O = 0.6\text{ V}$, $V_E = 2.0\text{ V}$, $I_{OL} = 13\text{ mA}$	All	-	3	5	mA
I_{OH}	HIGH Level Output Current	$V_O = 5.5\text{ V}$, $I_F = 250\ \mu\text{A}$, $V_E = 2.0\text{ V}$	All	-	-	100	μA
V_{OL}	LOW Level Output Voltage	$I_F = 5\text{ mA}$, $V_E = 2.0\text{ V}$, $I_{OL} = 13\text{ mA}$	All	-	0.4	0.6	V

SWITCHING CHARACTERISTICS ($V_{CC} = 5\text{ V}$, $I_F = 7.5\text{ mA}$, $T_A = -40^\circ\text{C}$ to $+85^\circ\text{C}$ unless otherwise specified)

t_{PHL}	Propagation Delay Time to Logic LOW	$R_L = 350\ \Omega$, $C_L = 15\text{ pF}$, $T_A = 25^\circ\text{C}$ (Note 5) (Figure 23)	All	25	40	75	ns
		$R_L = 350\ \Omega$, $C_L = 15\text{ pF}$ (Note 5) (Figure 23)		-	-	100	
t_{PLH}	Propagation Delay Time to Logic HIGH	$R_L = 350\ \Omega$, $C_L = 15\text{ pF}$, $T_A = 25^\circ\text{C}$ (Note 6) (Figure 23)	All	20	40	75	ns
		$R_L = 350\ \Omega$, $C_L = 15\text{ pF}$ (Note 6) (Figure 23)		-	-	100	
$ t_{PHL} - t_{PLH} $	Pulse Width Distortion	$R_L = 350\ \Omega$, $C_L = 15\text{ pF}$ (Figure 23)	All	-	1	35	ns
t_R	Output Rise Time (10% to 90%)	$R_L = 350\ \Omega$, $C_L = 15\text{ pF}$ (Note 7) (Figure 23)	All	-	30	-	ns
t_F	Output Fall Time (90% to 10%)	$R_L = 350\ \Omega$, $C_L = 15\text{ pF}$ (Note 8) (Figure 23)	All	-	10	-	ns
t_{EHL}	Enable Propagation Delay Time to Output LOW Level	$V_{EH} = 3.5\text{ V}$, $R_L = 350\ \Omega$, $C_L = 15\text{ pF}$ (Note 9) (Figure 24)	Single Channel	-	15	-	ns
t_{ELH}	Enable Propagation Delay Time to Output HIGH Level	$V_{EH} = 3.5\text{ V}$, $R_L = 350\ \Omega$, $C_L = 15\text{ pF}$ (Note 10) (Figure 24)	Single Channel	-	15	-	ns
$ CM_H $	Common Mode Transient Immunity at Logic High	$I_F = 0\text{ mA}$, $V_{CM} = 50\text{ V}_{PEAK}$, $R_L = 350\ \Omega$, $T_A = 25^\circ\text{C}$ (Note 11) (Figure 25)	6N137M, HCPL2630M	-	10,000	-	V/ μs
			HCPL2601M, HCPL2631M	5000	10,000	-	
		$I_F = 0\text{ mA}$, $V_{CM} = 400\text{ V}_{PEAK}$, $R_L = 350\ \Omega$, $T_A = 25^\circ\text{C}$ (Note 11) (Figure 25)	HCPL2611M	10,000	15,000	-	

Single-Channel: 6N137M, HCPL2601M, HCPL2611M Dual-Channel: HCPL2630M, HCPL2631M

ELECTRICAL CHARACTERISTICS (continued)

Symbol	Parameter	Test Conditions	Device	Min	Typ	Max	Unit
SWITCHING CHARACTERISTICS ($V_{CC} = 5\text{ V}$, $I_F = 7.5\text{ mA}$, $T_A = -40^\circ\text{C}$ to $+85^\circ\text{C}$ unless otherwise specified)							
CM _L	Common Mode Transient Immunity at Logic Low	$V_{CM} = 50\text{ V}_{PEAK}$, $R_L = 350\ \Omega$, $T_A = 25^\circ\text{C}$ (Note 11) (Figure 25)	6N137M, HCPL2630M	–	10,000	–	V/ μs
			HCPL2601M, HCPL2631M	5000	10,000	–	
		$V_{CM} = 400\text{ V}_{PEAK}$, $R_L = 350\ \Omega$, $T_A = 25^\circ\text{C}$ (Note 11) (Figure 25)	HCPL2611M	10,000	15,000	–	

ISOLATION CHARACTERISTICS ($T_A = 25^\circ\text{C}$, unless otherwise noted)

V_{ISO}	Withstand Insulation Test Voltage	Relative Humidity $\leq 50\%$, $I_{I-O} \leq 10\ \mu\text{A}$, $t = 1\text{ min}$, $f = 50\text{ Hz}$ (Note 12) (Note 13)	All	5,000	–	–	VAC_{RMS}
R_{I-O}	Resistance (Input to Output)	$V_{I-O} = 500\text{ V}_{DC}$ (Note 12)	All	–	10^{11}	–	Ω
C_{I-O}	Capacitance (Input to Output)	$f = 1\text{ MHz}$, $V_{I-O} = 0\text{ V}_{DC}$ (Note 12)	All	–	1	–	pF
I_{I-O}	Input-Output Insulation Leakage Current	Relative Humidity $\leq 45\%$, $V_{I-I} = 3000\text{ V}_{DC}$, $t = 5\text{ s}$ (Note 12)	All	–	–	1.0	μA

Product parametric performance is indicated in the Electrical Characteristics for the listed test conditions, unless otherwise noted. Product performance may not be indicated by the Electrical Characteristics if operated under different conditions.

4. Enable Input – No pull up resistor required as the device has an internal pull up resistor.
5. t_{PHL} – Propagation delay is measured from the 3.75 mA level on the LOW to HIGH transition of the input current pulse to the 1.5 V level on the HIGH to LOW transition of the output voltage pulse.
6. t_{PLH} – Propagation delay is measured from the 3.75 mA level on the HIGH to LOW transition of the input current pulse to the 1.5 V level on the LOW to HIGH transition of the output voltage pulse.
7. t_R – Rise time is measured from the 10% to the 90% levels on the LOW to HIGH transition of the output pulse.
8. t_F – Fall time is measured from the 90% to the 10% levels on the HIGH to LOW transition of the output pulse.
9. t_{EHL} – Enable input propagation delay is measured from the 1.5 V level on the LOW to HIGH transition of the input voltage pulse to the 1.5 V level on the HIGH to LOW transition of the output voltage pulse.
10. t_{ELH} – Enable input propagation delay is measured from the 1.5 V level on the HIGH to LOW transition of the input voltage pulse to the 1.5 V level on the LOW to HIGH transition of the output voltage pulse.
11. Common mode transient immunity in logic high level is the maximum tolerable (positive) dV_{cm}/dt on the leading edge of the common mode pulse signal, V_{CM} , to assure that the output will remain in a logic high state (i.e., $V_O > 2.0\text{ V}$). Common mode transient immunity in logic low level is the maximum tolerable (negative) dV_{cm}/dt on the trailing edge of the common mode pulse signal, V_{CM} , to assure that the output will remain in a logic low state (i.e., $V_O < 0.8\text{ V}$).
12. Device is considered a two terminal device: pins 1, 2, 3 and 4 are shorted together and pins 5, 6, 7 and 8 are shorted together.
13. 5000 VAC_{RMS} for 1 minute duration is equivalent to 6000 VAC_{RMS} for 1 second duration

Single-Channel: 6N137M, HCPL2601M, HCPL2611M Dual-Channel: HCPL2630M, HCPL2631M

TYPICAL PERFORMANCE CURVES

(For Single-Channel Devices: 6N137M, HCPL2601M, and HCPL2611M)

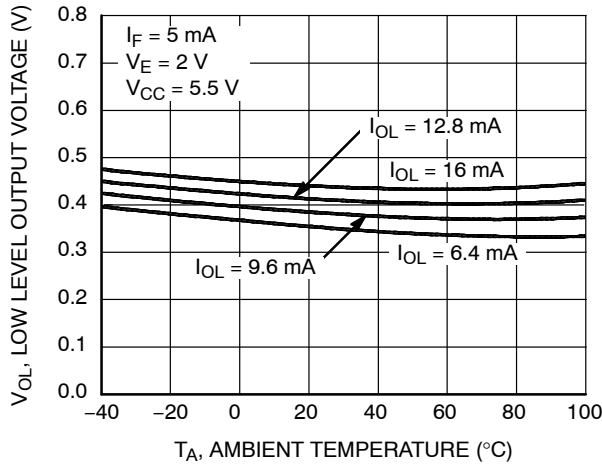

Figure 2. Low Level Output Voltage vs. Ambient Temperature

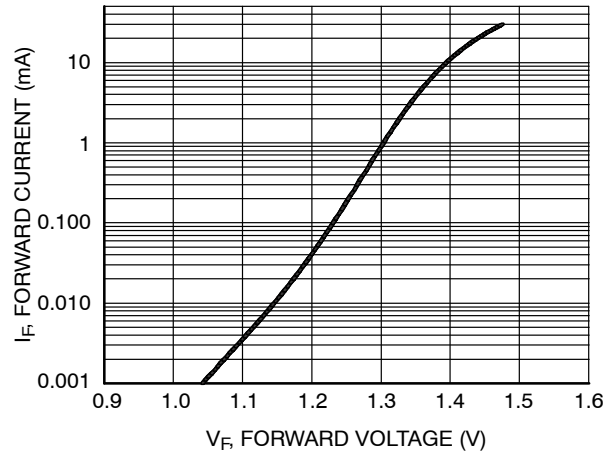

Figure 3. Input Diode Forward Voltage vs. Forward Current

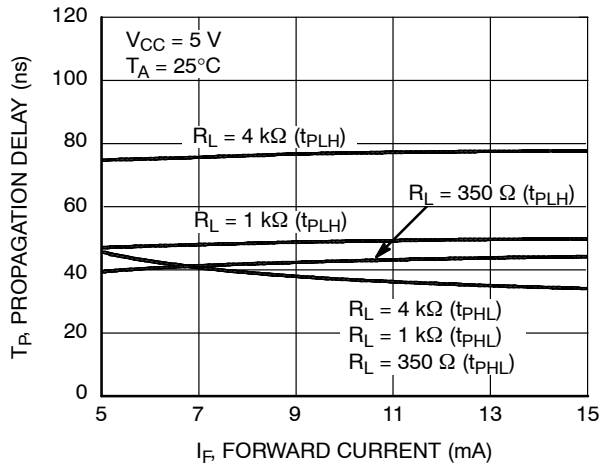

Figure 4. Switching Time vs. Forward Current

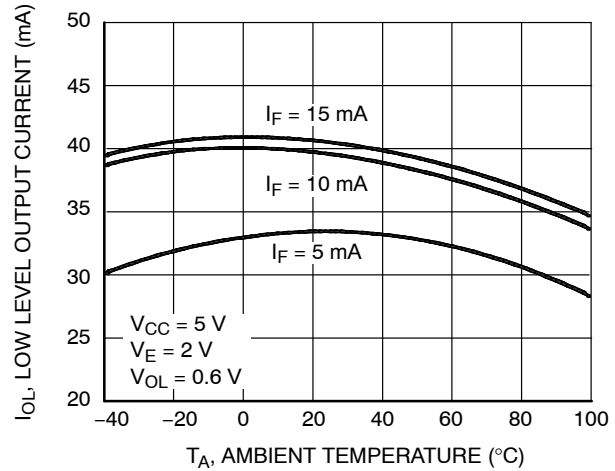

Figure 5. Low Level Output vs. Ambient Temperature

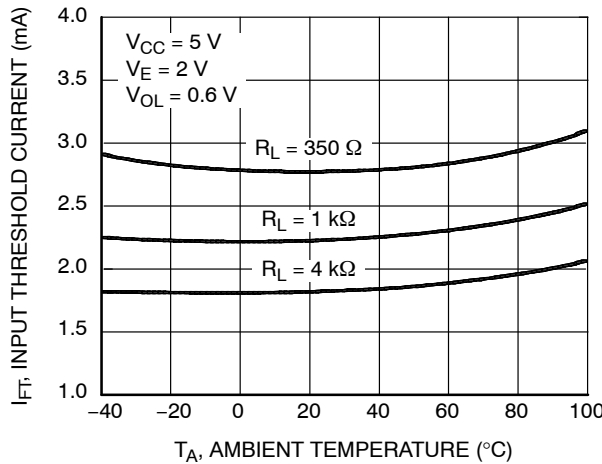

Figure 6. Input Threshold Current vs. Ambient Temperature

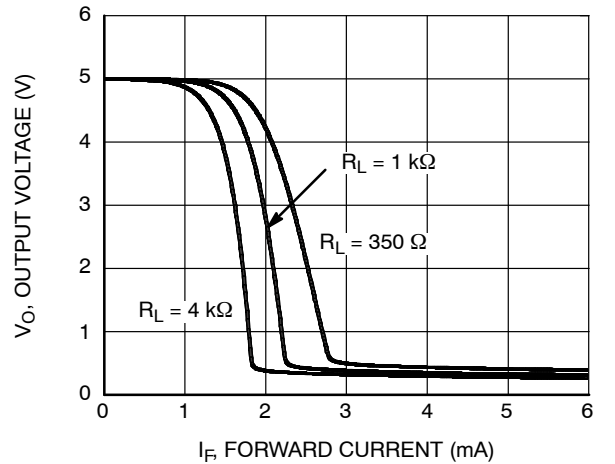

Figure 7. Output Voltage vs. Input Forward Current

Single-Channel: 6N137M, HCPL2601M, HCPL2611M Dual-Channel: HCPL2630M, HCPL2631M

TYPICAL PERFORMANCE CURVES (Continued)

(For Single-Channel Devices: 6N137M, HCPL2601M, HCPL2611M)

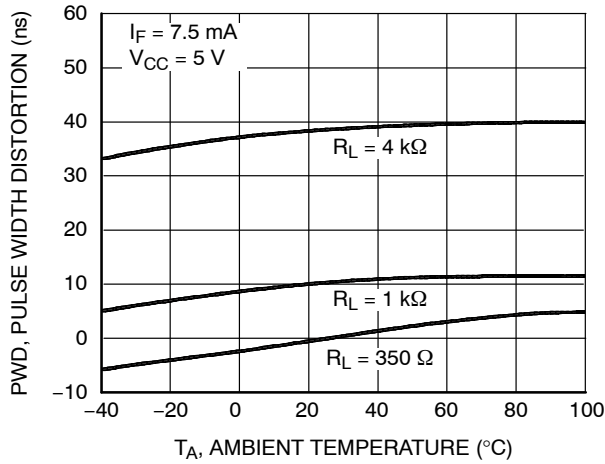

Figure 8. Pulse Width Distortion vs. Temperature

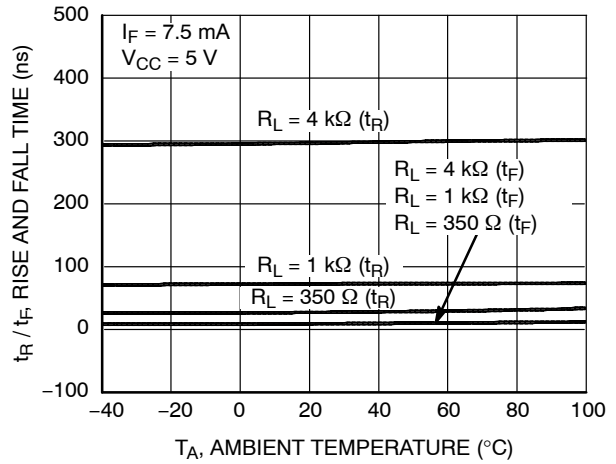

Figure 9. Rise and Fall Time vs. Temperature



Figure 10. Enable Propagation Delay vs. Temperature



Figure 11. Switching Time vs. Temperature



Figure 12. High Level Output Current vs. Temperature

Single-Channel: 6N137M, HCPL2601M, HCPL2611M Dual-Channel: HCPL2630M, HCPL2631M

TYPICAL PERFORMANCE CURVES (Continued)

(For Dual-Channel Devices: HCPL2630M and HCPL2631M)

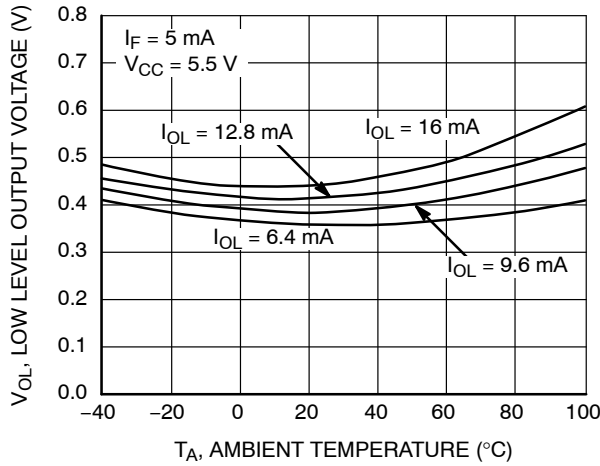

Figure 13. Low Level Output Voltage vs. Ambient Temperature

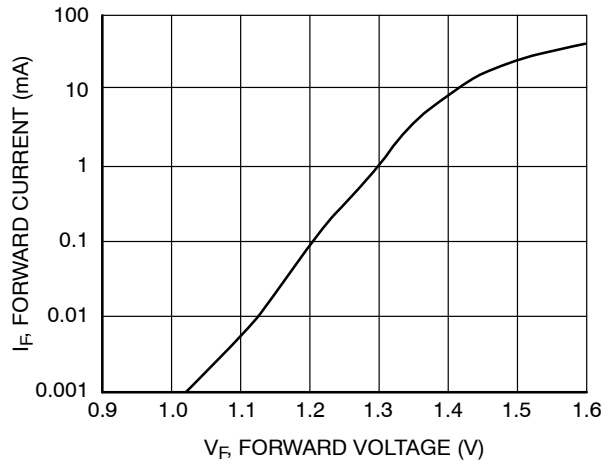

Figure 14. Input Diode Forward Voltage vs. Forward Current

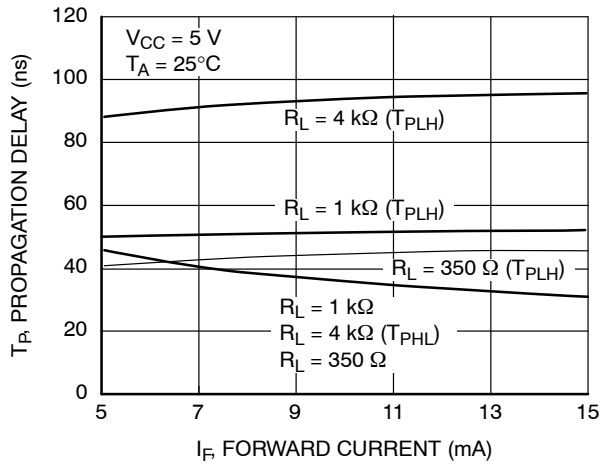

Figure 15. Switching Time vs. Forward Current

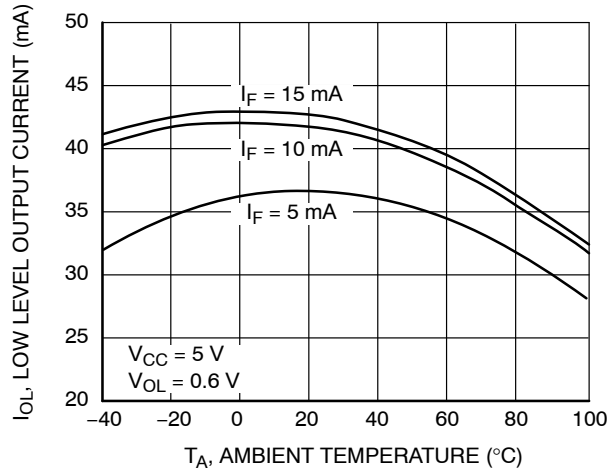

Figure 16. Low Level Output Current vs. Ambient Temperature

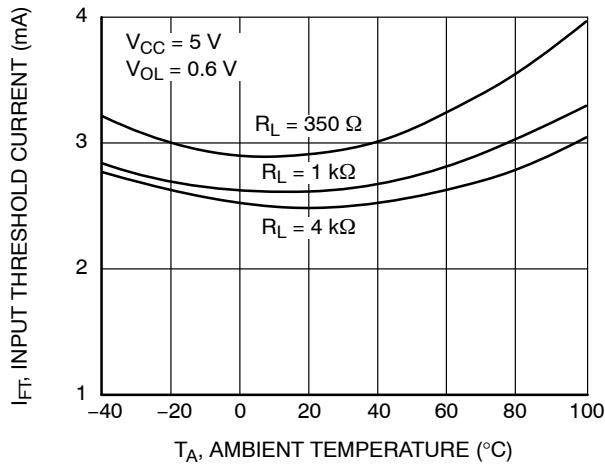

Figure 17. Input Threshold Current vs. Ambient Temperature

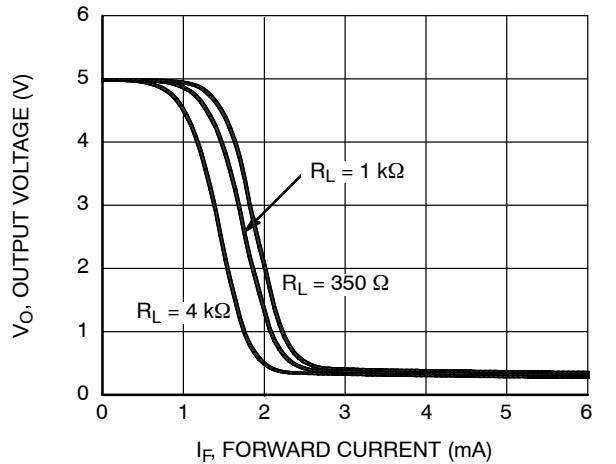

Figure 18. Output Voltage vs. Input Forward Current

Single-Channel: 6N137M, HCPL2601M, HCPL2611M Dual-Channel: HCPL2630M, HCPL2631M

TYPICAL PERFORMANCE CURVES (Continued)

(For Dual-Channel Devices: HCPL2630M and HCPL2631M)

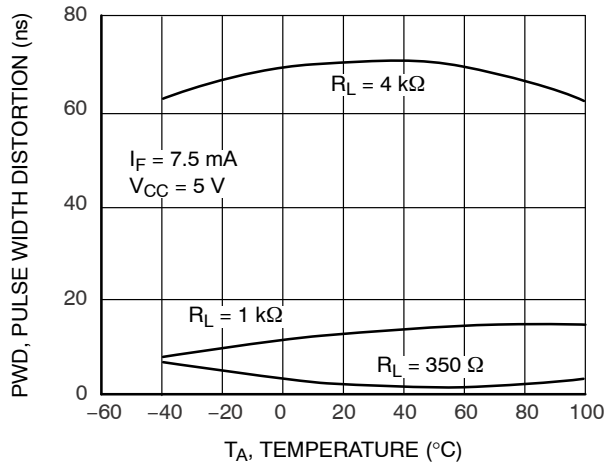

Figure 19. Pulse Width Distortion vs. Temperature

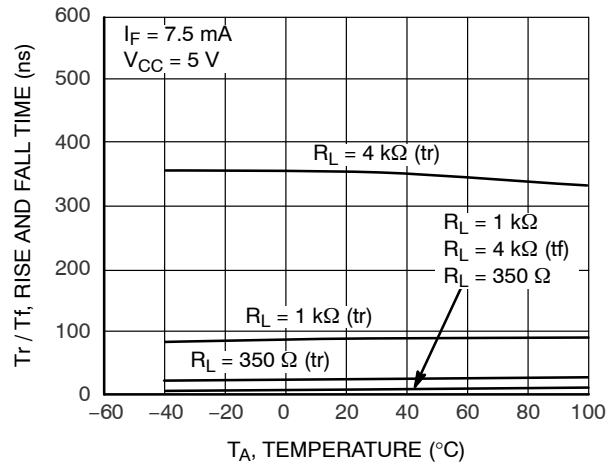

Figure 20. Rise and Fall Time vs. Temperature

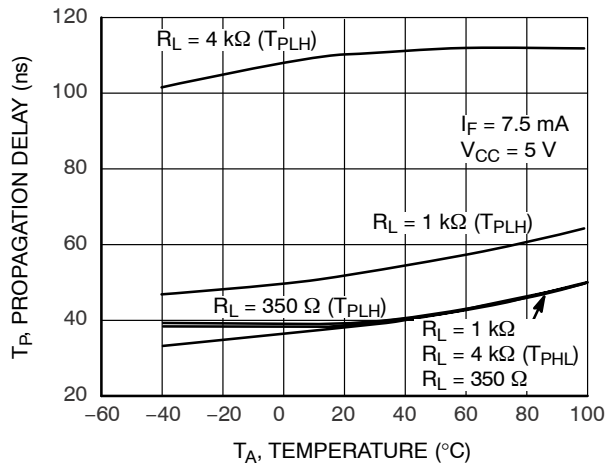

Figure 21. Switching Time vs. Temperature

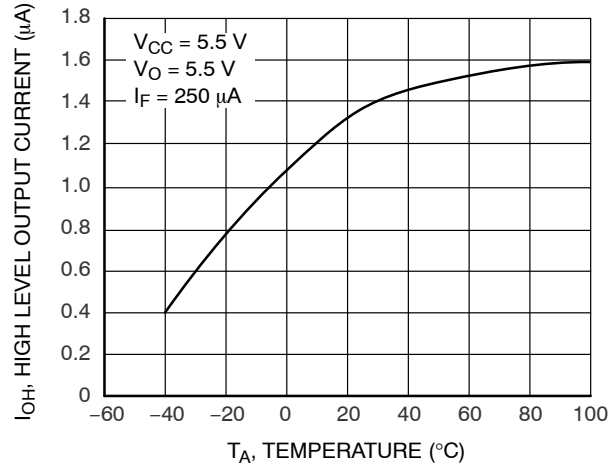

Figure 22. High Level Output Current vs. Temperature

Single-Channel: 6N137M, HCPL2601M, HCPL2611M Dual-Channel: HCPL2630M, HCPL2631M

TEST CIRCUITS



Figure 23. Test Circuit and Waveforms for t_{PLH} , t_{PHL} , t_r and t_f

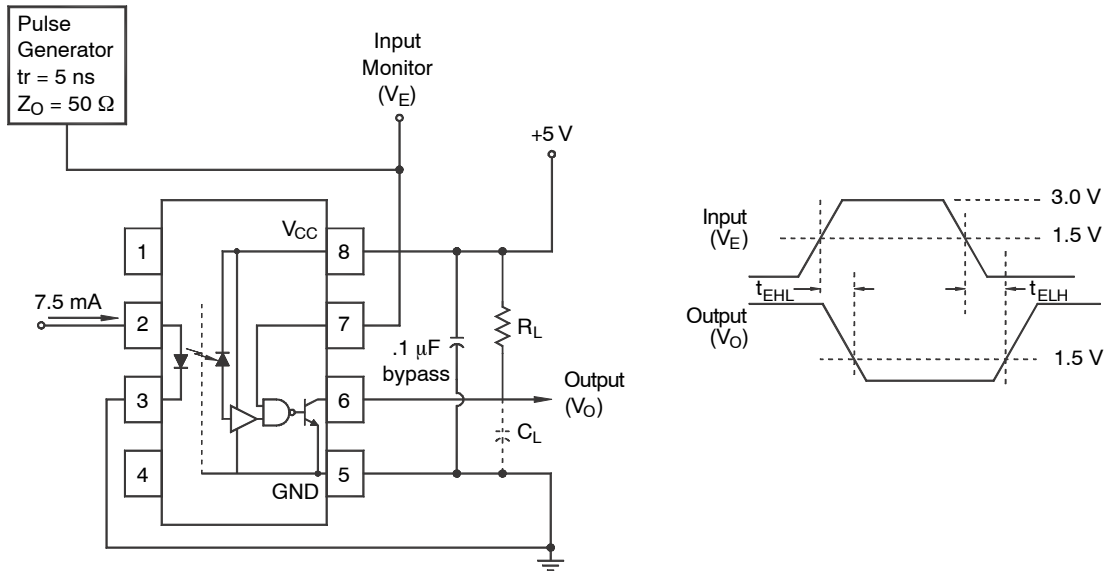

Figure 24. Test Circuit t_{EHL} and t_{ELH}

Single-Channel: 6N137M, HCPL2601M, HCPL2611M Dual-Channel: HCPL2630M, HCPL2631M

TEST CIRCUITS (Continued)

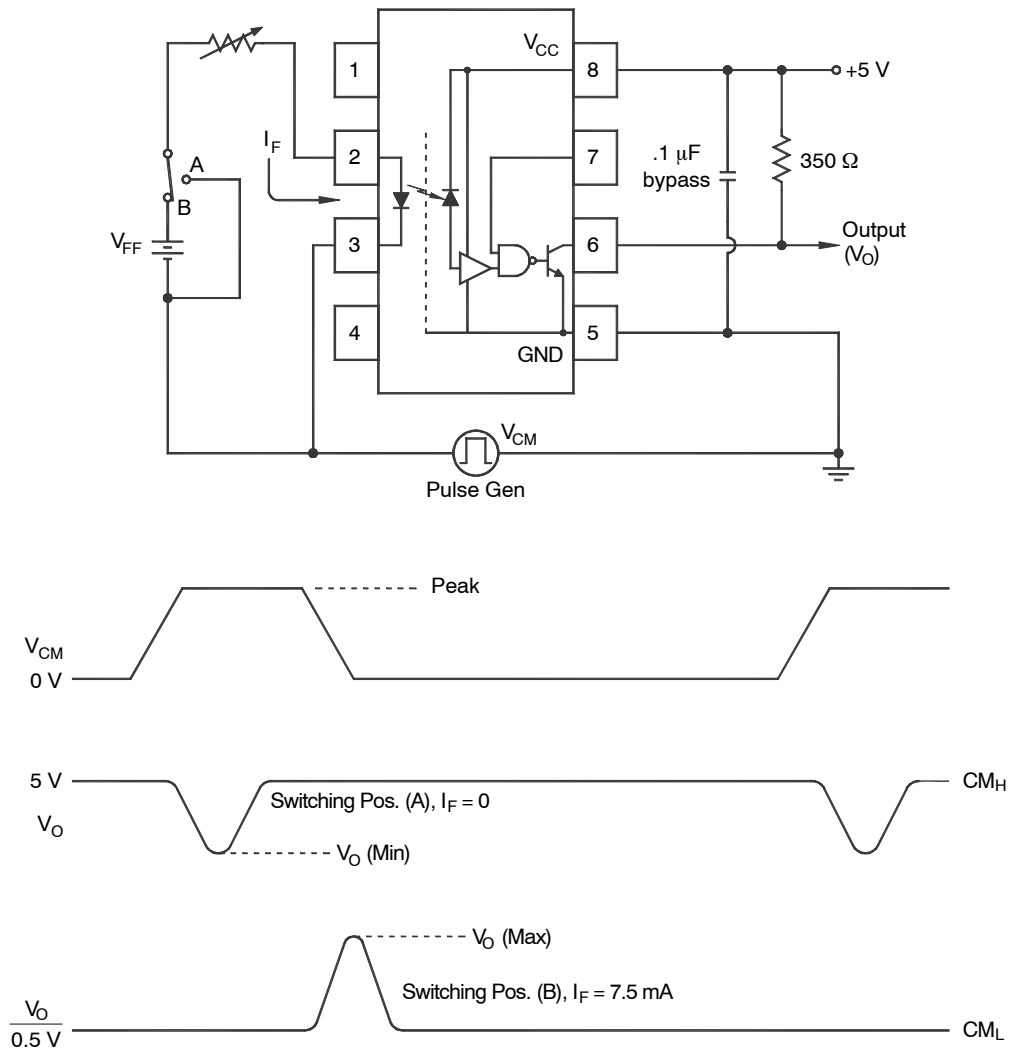
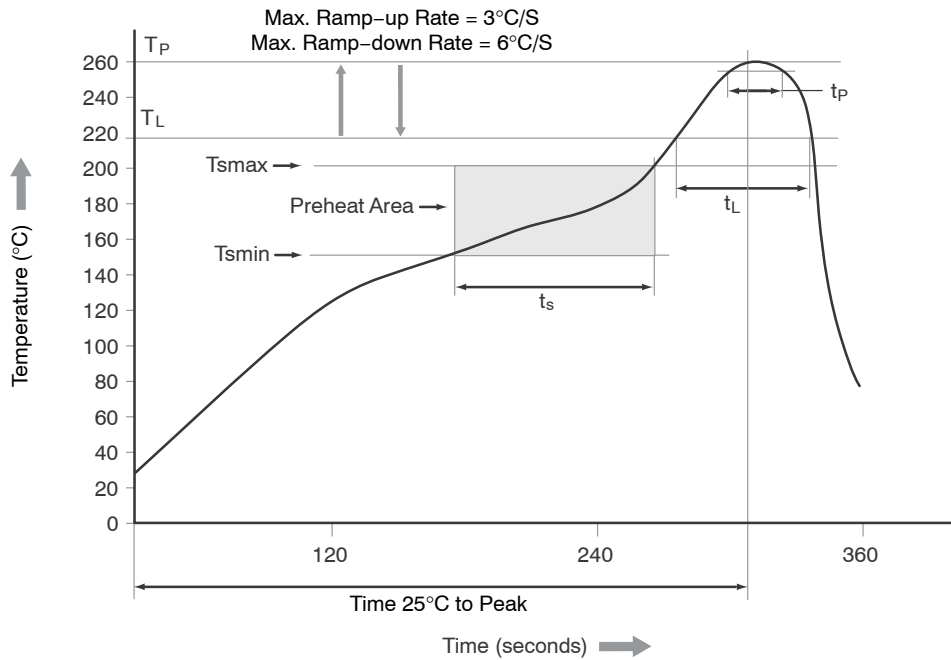

Figure 25. Test Circuit Common Mode Transient Immunity

Single-Channel: 6N137M, HCPL2601M, HCPL2611M Dual-Channel: HCPL2630M, HCPL2631M

REFLOW PROFILE



Profile Feature	Pb-Free Assembly Profile
Temperature Minimum (T _{smin})	150°C
Temperature Maximum (T _{smax})	200°C
Time (t _s) from (T _{smin} to T _{smax})	60 to 120 s
Ramp-up Rate (t _L to t _p)	3°C/second maximum
Liquidous Temperature (T _L)	217°C
Time (t _L) Maintained Above (T _L)	60 to 150 s
Peak Body Package Temperature	260°C +0°C / -5°C
Time (t _p) within 5°C of 260°C	30 s
Ramp-down Rate (T _P to T _L)	6°C/s maximum
Time 25°C to Peak Temperature	8 minutes maximum

Figure 26. Reflow Profile

**Single-Channel: 6N137M, HCPL2601M, HCPL2611M Dual-Channel: HCPL2630M,
HCPL2631M**

ORDERING INFORMATION (Note 14)

Part Number	Package	Shipping [†]
6N137M	PDIP8 9.655x6.6, 2.54P, CASE 646CQ DIP8-Pin (Pb-Free)	50 Units / Tube
6N137SM	PDIP8 GW, CASE 709AC SMT 8-Pin (Lead Bend) (Pb-Free)	50 Units / Tube
6N137SDM	PDIP8 GW, CASE 709AC SMT 8-Pin (Lead Bend) (Pb-Free)	1000 / Tape & Reel
6N137VM	PDIP8 9.655x6.6, 2.54P, CASE 646CQ DIP 8-Pin, DIN EN/IEC 60747-5-5 Option (Pb-Free)	50 Units / Tube
6N137SVM	PDIP8 GW, CASE 709AC SMT 8-Pin (Lead Bend), DIN EN/IEC 60747-5-5 Option (Pb-Free)	50 Units / Tube
6N137SDVM	PDIP8 GW, CASE 709AC SMT 8-Pin (Lead Bend), DIN EN/IEC 60747-5-5 Option (Pb-Free)	1000 / Tape & Reel
6N137TVM	PDIP8 6.6x3.81, 2.54P, CASE 646BW DIP 8-Pin, 0.4" Lead Spacing, DIN EN/IEC60747-5-5 Option (Pb-Free)	50 Units / Tube
6N137TSVM	PDIP8 GW, CASE 709AD SMT 8-Pin, 0.4" Lead Spacing, DIN EN/IEC60747-5-5 Option (Pb-Free)	50 Units / Tube
6N137TSR2VM	PDIP8 GW, CASE 709AD SMT 8-Pin, 0.4" Lead Spacing, DIN EN/IEC60747-5-5 Option (Pb-Free)	1000 / Tape & Reel

[†]For information on tape and reel specifications, including part orientation and tape sizes, please refer to our Tape and Reel Packaging Specifications Brochure, BRD8011/D.

14. The product orderable part number system listed in this table also applies to the HCPL2601M, HCPL2611M, HCPL2630M and HCPL2631M product families.

MECHANICAL CASE OUTLINE
PACKAGE DIMENSIONS

ON Semiconductor®



PDIP8 6.6x3.81, 2.54P
CASE 646BW
ISSUE O

DATE 31 JUL 2016



- NOTES:
A) NO STANDARD APPLIES TO THIS PACKAGE
B) ALL DIMENSIONS ARE IN MILLIMETERS.
C) DIMENSIONS ARE EXCLUSIVE OF BURRS, MOLD FLASH, AND TIE BAR EXTRUSION

DOCUMENT NUMBER:	98AON13445G	Electronic versions are uncontrolled except when accessed directly from the Document Repository. Printed versions are uncontrolled except when stamped "CONTROLLED COPY" in red.
DESCRIPTION:	PDIP8 6.6X3.81, 2.54P	PAGE 1 OF 1

ON Semiconductor and are trademarks of Semiconductor Components Industries, LLC dba ON Semiconductor or its subsidiaries in the United States and/or other countries. ON Semiconductor reserves the right to make changes without further notice to any products herein. ON Semiconductor makes no warranty, representation or guarantee regarding the suitability of its products for any particular purpose, nor does ON Semiconductor assume any liability arising out of the application or use of any product or circuit, and specifically disclaims any and all liability, including without limitation special, consequential or incidental damages. ON Semiconductor does not convey any license under its patent rights nor the rights of others.

MECHANICAL CASE OUTLINE

PACKAGE DIMENSIONS

ON Semiconductor®



PDIP8 9.655x6.6, 2.54P
CASE 646CQ
ISSUE O

DATE 18 SEP 2017

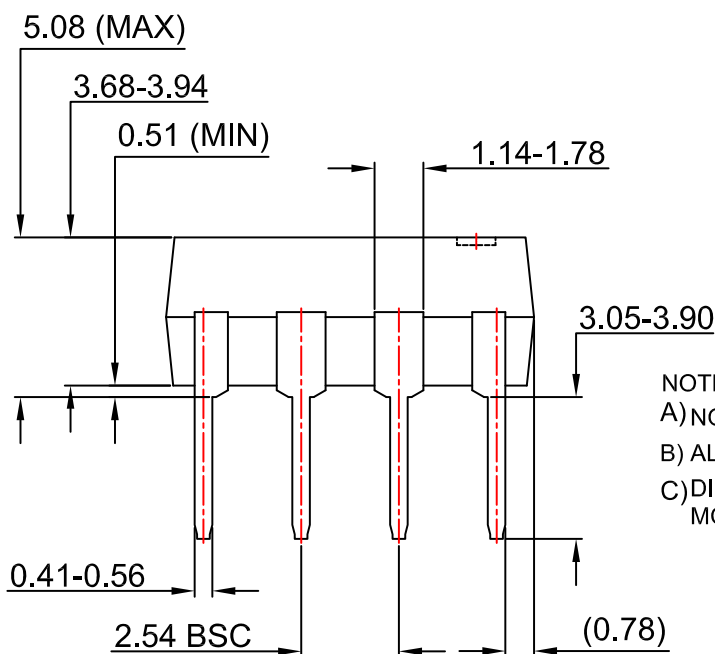

NOTES:
A) NO STANDARD APPLIES TO THIS PACKAGE
B) ALL DIMENSIONS ARE IN MILLIMETERS.
C) DIMENSIONS ARE EXCLUSIVE OF BURRS, MOLD FLASH, AND TIE BAR EXTRUSION

DOCUMENT NUMBER:	98AON13446G	Electronic versions are uncontrolled except when accessed directly from the Document Repository. Printed versions are uncontrolled except when stamped "CONTROLLED COPY" in red.
DESCRIPTION:	PDIP8 9.655X6.6, 2.54P	PAGE 1 OF 1

ON Semiconductor and are trademarks of Semiconductor Components Industries, LLC dba ON Semiconductor or its subsidiaries in the United States and/or other countries. ON Semiconductor reserves the right to make changes without further notice to any products herein. ON Semiconductor makes no warranty, representation or guarantee regarding the suitability of its products for any particular purpose, nor does ON Semiconductor assume any liability arising out of the application or use of any product or circuit, and specifically disclaims any and all liability, including without limitation special, consequential or incidental damages. ON Semiconductor does not convey any license under its patent rights nor the rights of others.

MECHANICAL CASE OUTLINE

PACKAGE DIMENSIONS

ON Semiconductor®



PDIP8 GW
CASE 709AC
ISSUE O

DATE 31 JUL 2016



LAND PATTERN RECOMMENDATION

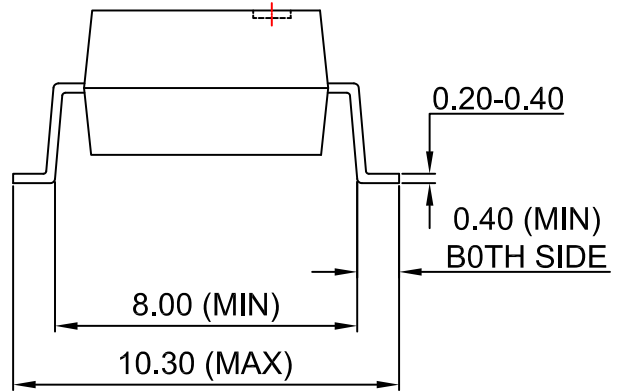

NOTES:

- A) NO STANDARD APPLIES TO THIS PACKAGE
- B) ALL DIMENSIONS ARE IN MILLIMETERS.
- C) DIMENSIONS ARE EXCLUSIVE OF BURRS, MOLD FLASH, AND TIE BAR EXTRUSION

DOCUMENT NUMBER:	98AON13447G	Electronic versions are uncontrolled except when accessed directly from the Document Repository. Printed versions are uncontrolled except when stamped "CONTROLLED COPY" in red.
DESCRIPTION:	PDIP8 GW	PAGE 1 OF 1

ON Semiconductor and are trademarks of Semiconductor Components Industries, LLC dba ON Semiconductor or its subsidiaries in the United States and/or other countries. ON Semiconductor reserves the right to make changes without further notice to any products herein. ON Semiconductor makes no warranty, representation or guarantee regarding the suitability of its products for any particular purpose, nor does ON Semiconductor assume any liability arising out of the application or use of any product or circuit, and specifically disclaims any and all liability, including without limitation special, consequential or incidental damages. ON Semiconductor does not convey any license under its patent rights nor the rights of others.