

HDI SERIES – AMPLIFIED PRESSURE SENSORS

The HDI pressure sensors perform precision digital signal conditioning and provide analog and digital output at the same time. The sensors are calibrated, temperature compensated and linearized and achieve very high total accuracies. They are intended to be used with dry and non-corrosive gases. Miniature SMT and DIP housings allow for space-saving PCB-mounting and maximum OEM design flexibility. All HDI pressure sensors can be modified according to customer specific requirements.

Features

- Pressure ranges from 10 mbar to 5 bar, absolute, gage or differential pressure
- Digital I²C bus and analog output
- Precision ASIC signal conditioning
- Calibrated and temperature compensated
- SMT and DIP housings

Applications

- Medical devices
- Instrumentation
- HVAC
- Industrial controls
- Pneumatic controls
- Environmental controls

Certificates

- RoHS and REACH compliant

Media compatibility

To be used with non-corrosive, non-ionic working fluids such as clean dry air, dry gases and the like.

[CLICK HERE >](#)
CONNECT WITH A SPECIALIST

HDI SERIES – AMPLIFIED PRESSURE SENSORS

Maximum ratings

Parameter		Min.	Typ.	Max.	Unit
Supply voltage V_S	HDIxxx3	2.7	3	3.3	V_{DC}
	HDIxxx5	4.5	5	5.5	
Output current	Sink		1		mA
	Source		1		mA
Lead specifications	Average preheating temperature gradient			2.5	K/s
	Soak time			approx. 3	min
	Time above 217 °C			50	s
	Time above 230 °C			40	
	Time above 250 °C			15	
	Peak temperature			260	°C
	Cooling temperature gradient			-3.5	K/s
Temperature ranges ⁽¹⁾	Compensated	0		+85	°C
	Operating	-20		+85	
	Storage	-40		+125	

Pressure sensor characteristics

Part no.	Operating pressure	Proof pressure ⁽²⁾	Burst pressure ⁽³⁾
HDIM010xxxBxxx	0 to ±10 mbar	150 mbar	200 mbar
HDIM020xxxBxxx	0 to ±20 mbar		
HDIM050xxxBxxx	0 to ±50 mbar	550 mbar	800 mbar
HDIM100xxxBxxx	0 to ±100 mbar	1 bar	1.5 bar
HDIM200xxxBxxx	0 to ±200 mbar		
HDIM500xxxBxxx	0 to ±500 mbar		
HDIB001xxxBxxx	0 to ±1 bar	2 bar	3 bar
HDIM010xxxUxxx	0 to 10 mbar	150 mbar	200 mbar
HDIM020xxxUxxx	0 to 20 mbar		
HDIM050xxxUxxx	0 to 50 mbar	550 mbar	800 mbar
HDIM100xxxUxxx	0 to 100 mbar	1 bar	1.5 bar
HDIM200xxxUxxx	0 to 200 mbar		
HDIM500xxxUxxx	0 to 500 mbar		
HDIB001xxxUxxx	0 to 1 bar	2 bar	5 bar
HDIB002xxxUxxx	0 to 2 bar	4 bar	6 bar
HDIB005xxxUxxx	0 to 5 bar	7 bar	7 bar
HDI0611ARxxx	600 to 1100 mbar(a)	2 bara	3 bara
HDI0811ARxxx	800 to 1100 mbar(a)		

Other pressure ranges are available on request. Please contact your local sensors representative.

HDI SERIES – AMPLIFIED PRESSURE SENSORS

Performance characteristics

($V_S=5.0 V_{DC}$, $T_A=25\text{ }^\circ\text{C}$, $RH=50\%$, analog output signal is ratiometric to V_S , digital output signal is not ratiometric to V_S)

All HDIxxxP5 devices ($V_S= 5.0$)

Characteristics		Min.	Typ.	Max.	Unit
Total accuracy (0 to 85°C) ⁽⁴⁾	all barometric devices			±1.0	%FSS
	all other devices			±0.5	
Response delay ^(5,6)			0.5		ms
A/D resolution ⁽⁶⁾			12		bit
D/A resolution				11	
Current consumption ⁽⁷⁾			5		mA

All HDIxxxRxxxP5 (barometric devices)

Characteristics	Min.	Typ.	Max.	Unit
ANALOG				
Output at min. specified pressure	0.46	0.50	0.54	V
Full scale span (FSS) ⁽⁸⁾		4.00		
Full scale output	4.46	4.50	4.52	
DIGITAL				
Output at min. specified pressure	3015	3277	3539	counts
Full scale span (FSS) ⁽⁸⁾		26214		
Full scale output	29228	29490	29752	

All HDIxxxUxxxP5 (Unidirectional devices)

Characteristics	Min.	Typ.	Max.	Unit
ANALOG				
Zero pressure offset	0.48	0.50	0.52	V
Full scale span (FSS) ⁽⁸⁾		4.00		
Full scale output	4.48	4.50	4.52	
DIGITAL				
Zero pressure offset	3146	3277	3480	counts
Full scale span (FSS) ⁽⁸⁾		26214		
Full scale output	29359	29490	29621	

ALL HDIxxxBxxxP5 (Bidirectional device)

Characteristics	Min.	Typ.	Max.	Unit
ANALOG				
Zero pressure offset	2.48	2.50	2.52	V
Full scale span (FSS) ⁽⁸⁾		4.00		
Output	@ max. specified pressure	4.48	4.50	
	@ min. specified pressure	0.48	0.50	
DIGITAL				
Zero pressure offset	16252	16384	16515	counts
Full scale span (FSS) ⁽⁸⁾		26214		
Output	@ max. specified pressure	29359	29490	
	@ min. specified pressure	3146	3277	

HDI SERIES – AMPLIFIED PRESSURE SENSORS

Performance characteristics

($V_S = 3.0 V_{DC}$, $T_A = 25^\circ C$, $RH = 50\%$, analog output signal is ratiometric to V_S , digital output signal is not ratiometric to V_S)

All HDIxxxP3 devices ($V_S = 3.0$)

Characteristics		Min.	Typ.	Max.	Unit
Total accuracy (0 to 85°C) ⁽⁴⁾	all barometric devices			±1.0	%FSS
	all other devices			±0.5	
Response delay ^(5,6)			0.5		ms
A/D resolution ⁽⁶⁾			12		bit
D/A resolution				11	
Current consumption ⁽⁷⁾			3		mA

All HDIxxxRxxxP3 (barometric devices)

Characteristics	Min.	Typ.	Max.	Unit
ANALOG				
Output at min. specified pressure	0.23	0.25	0.27	V
Full scale span (FSS) ⁽⁸⁾		2.00		
Full scale output	2.23	2.25	2.27	
DIGITAL				
Output at min. specified pressure	2512	2731	2949	counts
Full scale span (FSS) ⁽⁸⁾		21845		
Full scale output	24357	24575	24794	

ALL HDIxxxUxxxP3 (Bidirectional device)

Characteristics	Min.	Typ.	Max.	Unit
ANALOG				
Zero pressure offset	0.24	0.25	0.26	V
Full scale span (FSS) ⁽⁸⁾		2.00		
Full scale output	2.24	2.25	2.26	
DIGITAL				
Zero pressure offset	2621	2731	2840	counts
Full scale span (FSS) ⁽⁸⁾		21845		
Full scale output	24466	24575	24684	

All HDIxxxBxxxP3 (Unidirectional devices)

Characteristics	Min.	Typ.	Max.	Unit	
ANALOG					
Zero pressure offset	1.24	1.25	1.26	V	
Full scale span (FSS) ⁽⁸⁾		2.00			
Output	@ max. specified pressure	2.24	2.25		2.26
	@ min. specified pressure	0.24	0.25		0.26
DIGITAL					
Zero pressure offset	13545	13653	13762	counts	
Full scale span (FSS) ⁽⁸⁾		21845			
Output	@ max. specified pressure	24466	24575		24684
	@ min. specified pressure	2621	2731		2840

I²C Bus

Introduction

The HDI is capable to generate a digital output signal. The device runs a cyclic program, which will store a corrected pressure value with 12 bit resolution about every 250 μs within the output registers of the internal ASIC. In order to use the sensor for digital signal readout, it should be connected to a bidirectional I²C-bus.

According to the I²C-bus specification, the bus is controlled by a master device, which generates the clock signal, controls the bus access and generates START and STOP conditions. The HDI is designed to work as a slave, hence it will only respond to requests from a master device.

Digital I²C interface

The HDI complies with the following protocol (Fig. 1):

Bus not busy: During idle periods both data line (SDA) and clock line (SCL) remain HIGH.

START condition (S): HIGH to LOW transition of SDA line while clock (SCL) is HIGH is interpreted as START condition. START conditions are always generated by the master. Each initial request for a pressure value has to begin with a START condition.

STOP condition (P): LOW to HIGH transition of SDA line while clock (SCL) is HIGH determines STOP condition. STOP conditions are always generated by the master. More than one request for the current pressure value can be transmitted without generation of intermediate STOP condition.

DATA valid (D): State of data line represents valid data when, after START condition, data line is stable for duration of HIGH period of clock signal. Data on line must be changed during LOW period of clock signal. There is one clock pulse per bit of data.

Acknowledge (A): Data is transferred in pieces of 8 bits (1 byte) on serial bus, MSB first. After each byte receiving device whether master or slave – is obliged to pull data line LOW as acknowledge for reception of data. Master must generate an extra clock pulse for this purpose. When acknowledge is missed, slave transmitter becomes inactive. It is on master either to send last command again or to generate STOP condition in that case.

Slave address: The I²C-bus master-slave concept requires a unique address for each device. The HDI has a preconfigured slave address (1111000xb). By factory programming it is possible to define a secondary slave address additional to the general one. According to I²C specification 127 different addresses are available. The sensor will then listen to both slave addresses. After generating a START condition the master sends the address byte containing a 7 bit address followed by a data direction bit (R/W). A "0" indicates a transmission from master to slave (WRITE), a "1" indicates a data request (READ).

DATA operation: The sensor starts to send 2 data bytes containing the current pressure value as a 15 bit information placed in the output registers.



Fig. 1: I²C bus protocol

I²C Interface parameters

Parameter	Symbol	Min.	Typ.	Max.	Unit
Input high level		90		100	
Input low level		0		10	% of Vs
Output low level				10	
Pull-up resistor		500			Ω
Load capacitance @ SDA	C _{SDA}			400	pF
Input capacitance @ SDA/SCL	C _{I2C_IN}			10	
SCL clock frequency	F _{SCL}	100*		400	kHz
Bus free time between STOP and START condition	t _{BUF}	1.3			μs
Hold time (repeated) START condition, to first clock pulse	t _{HD,STA}	0.8			
LOW period of SCL	t _{LOW}	1.3			
HIGH period of SCL	t _{HIGH}	0.6			
Setup time repeated START condition	t _{SU,STA}	1			
Data hold time	t _{HD,DAT}	0			
Data setup time	t _{SU,DAT}	0.2			
Rise time of both SDA and SCL	t _R			0.3	
Fall time of both SDA and SCL	t _F			0.3	
Setup time for STOP condition	t _{SU,STO}	0.6			

*recommended

Note: TE Connectivity recommends communication speeds of at least 100 kHz (max. 400 kHz). Please contact us for further information.



Fig. 2: Timing characteristics

HDI SERIES – AMPLIFIED PRESSURE SENSORS

Dimensional drawing

HDIxxxFxxx (DIP, 2 ports same side)



first angle projection
dimensions in mm

Dimensional drawing

HDIxxxExxx (SMD, 2 ports same side)

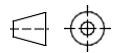

first angle projection
dimensions in mm

HDI SERIES – AMPLIFIED PRESSURE SENSORS

HDIxxxZxxx (DIP, 1 port axial)

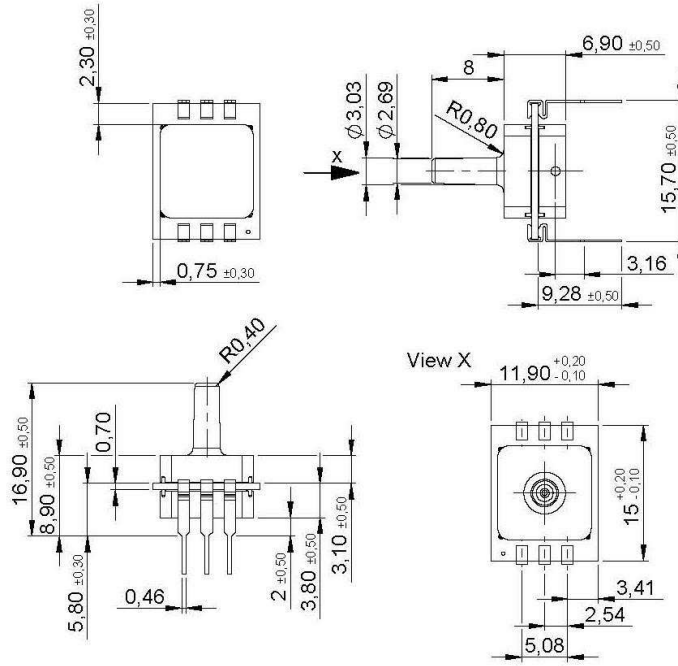

first angle projection
dimensions in mm

HDIxxxYxxx (SMD, 1 port axial)

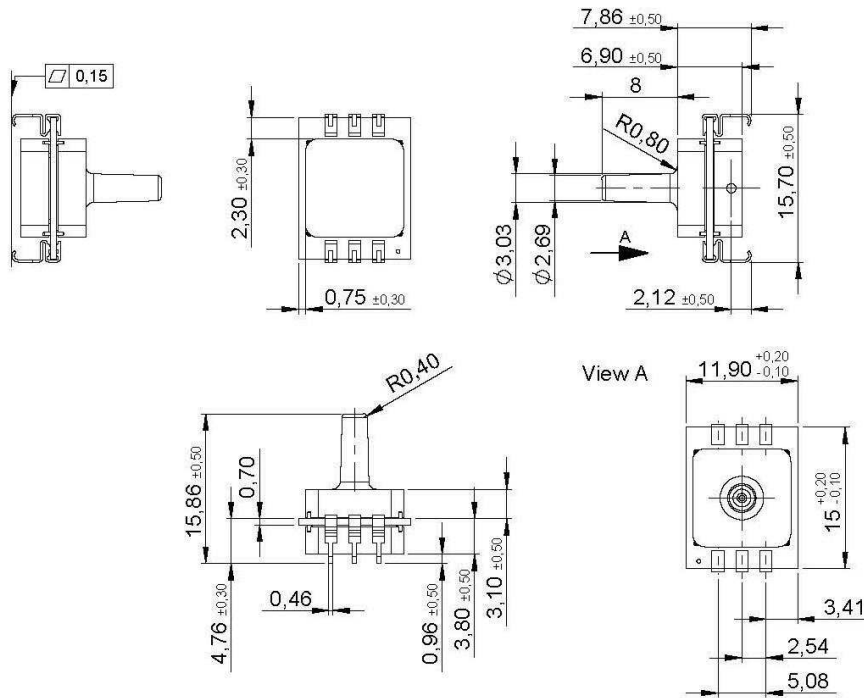

first angle projection
dimensions in mm

HDI SERIES – AMPLIFIED PRESSURE SENSORS

Electrical connection

HDI...A...
(absolute)



HDI...G...
(gage)



HDI...D...
(differential)



Pin	connection
1	+Vs
2	+Vout
3	GND
4	SDA
5	I/C*
6	SCL

* internal connection.
Do not connect for any reason

HDI SERIES – AMPLIFIED PRESSURE SENSORS

Part numbering key

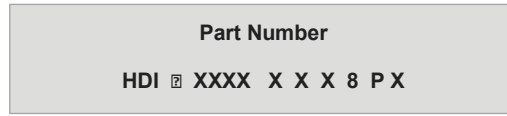

Pressure range

0611	600 to 1100 mbar
0811	800 to 1100 mbar
M010	10 mbar
M020	20 mbar
M050	50 mbar
M100	100 mbar
M200	200 mbar
M500	500 mbar
B001	1 bar
B002	2 bar
B005	5 bar

Pressure mode

A*	Absolute
D	Differential
G	Gage

*only from 1 bar

Calibration

B	Bidirectional
U	Unidirectional
R**	Barometric

* only up to 1 bar

**for pressure ranges 0611, 0811

Voltage

5	5V
3	3V

Grade

P	Prime
----------	-------

Porting

8	Straight
----------	----------

Housing

F*	[DIP, 2 ports same side]
E*	[SMD, 2 ports same side]
Z**	[DIP, 1 port axial]
Y**	[SMD, 1 port axial]

* standard for differential devices, "D"

**standard for absolute and gage devices, "A" and "G"

Order code example: HDIM050GUZ8P5

Note: Not all possible sensor configurations are active products. MOQ may apply.

Custom specific pressure ranges and mechanical or electronic sensor modifications are widely available. Please contact your local sensors representative to learn more.

HDI SERIES – AMPLIFIED PRESSURE SENSORS

Ordering information (standard configurations)

Description	TE Part Number	Pressure Range	Pressure mode	Calibration	Housing	Porting	Grade	Voltage
HDIM010GBZ8P5	2003438	10 mbar	Gage	Bidirectional	DIP, 1 port axial	Straight	Prime	5 V
HDIM100DUE8P5	2003098	100 mbar	Differential	Unidirectional	SMD, 2 ports same side	Straight	Prime	5 V
HDIM500GUY8P5	2003101	500 mbar	Gage	Unidirectional	SMD, 1 port axial	Straight	Prime	5 V
HDIB001GUZ8P3	2003188	1 bar	Gage	Unidirectional	DIP, 1 port axial	Straight	Prime	3 V
HDIB002AUY8P3	2003164	2 bar	Absolute	Unidirectional	SMD, 1 port axial	Straight	Prime	3 V

Note:

The above product listings are examples of possible product configurations. More standard product configurations are available on request.

In addition, custom specific pressure and temperature ranges as well as mechanical or electronic sensor modifications are widely available.

Please note, not all possible sensor configurations are active products. MOQ may apply. Please contact your local sensors representative to learn more.