

# HDSP-4830, HDSP-4840, HDSP-4850, HDSP-4832, HDSP-4836, HLCP-J100 10-Element Bar Graph Array

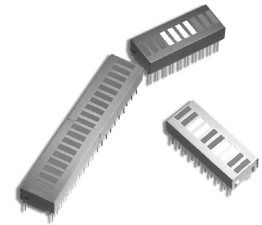

## Description

This Broadcom<sup>®</sup> family of 10-element LED arrays is designed to display information in easily recognizable bar graph form. The packages are end stackable and, therefore, capable of displaying long strings of information. Use of these bar graph arrays eliminates the alignment, intensity, and color matching problems associated with discrete LEDs. The HDSP-4830/4840/4850 and HLCPJ100 each contain LEDs of one color. The HDSP-4832/4836 are multicolor arrays with Red, Yellow, and Green LEDs in a single package.

## Features

- Custom multicolor array capability
- Matched LEDs for uniform appearance
- End stackable
- Package interlock ensures correct alignment
- Low profile package
- Rugged construction
- Large, easily recognizable segments
- High ON-OFF contrast, segment to segment
- Wide viewing angle
- Categorized for luminous intensity
- HDSP-4832/4836/4840/4850 categorized for dominant wavelength
- HLCP-J100 operates at low current
- Typical Intensity of 1.0 mcd at 1 mA drive current

## Applications

- Industrial controls
- Instrumentation
- Office equipment
- Computer peripherals
- Consumer products

# Package Drawing

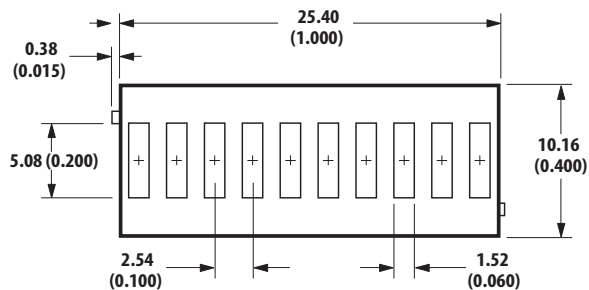

1. DIMENSIONS IN MILLIMETERS (INCHES).
2. ALL UNTOLERANCED DIMENSIONS FOR REFERENCE ONLY.
3. HDSP-4832/-4836/-4840/-4850 ONLY.

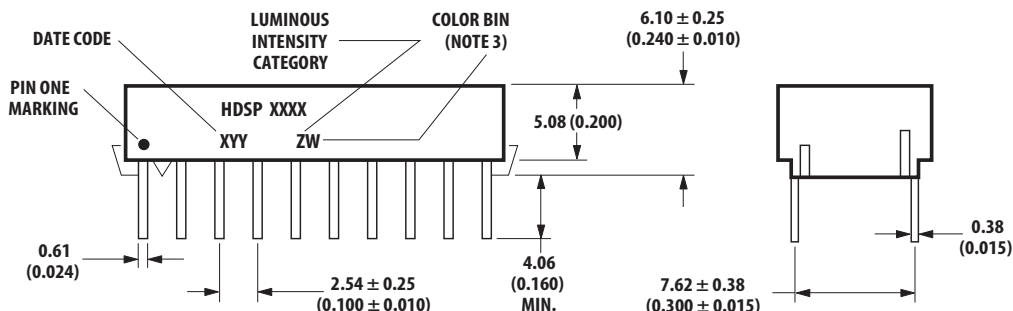

# Internal Circuit Diagram

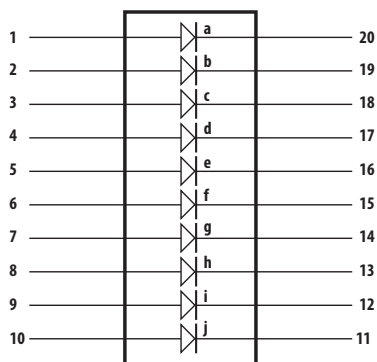

Pin	Function	Pin	Function
1	Anode a	11	Cathode j
2	Anode b	12	Cathode i
3	Anode c	13	Cathode h
4	Anode d	14	Cathode g
5	Anode e	15	Cathode f
6	Anode f	16	Cathode e
7	Anode g	17	Cathode d
8	Anode h	18	Cathode c
9	Anode i	19	Cathode b
10	Anode j	20	Cathode a

## Multicolor Array Segment Colors

Segment	HDSP-4832 Segment Color	HDSP-4836 Segment Color
a	Red	Red
b	Red	Red
c	Red	Yellow
d	Yellow	Yellow
e	Yellow	Green
f	Yellow	Green
g	Yellow	Yellow
h	Green	Yellow
i	Green	Red
j	Green	Red

## Absolute Maximum Ratings

**NOTE:** Absolute maximum ratings for Red, Yellow, and Green elements of the multicolor arrays are identical to the HDSP-4830/4840/4850 maximum ratings.

Parameter	AllInGaP Deep Red HLCP-J100	AllInGaP Red HDSP-4830	AllInGaP Yellow HDSP-4840	AllInGaP Green HDSP-4850	Unit
Power Dissipation per LED ( $T_A = 25^\circ\text{C}$ )	37.5	75	50	75	mW
Peak Forward Current per LED <sup>a</sup>	90	90	60	90	mA
DC Forward Current per LED <sup>b</sup>	15	30	20	30	mA
Operating Temperature Range	-20 to +100	-40 to +85	-40 to +85	-20 to +85	$^\circ\text{C}$
Storage Temperature Range	-55 to +100	-40 to +85	-40 to +85	-40 to +85	$^\circ\text{C}$
Reverse Voltage per LED <sup>c</sup>	5.0	3.0	3.0	3.0	V
Lead Solder Dipping Temperature for 5s (1.59 mm (1/16 inch) below seating plane)	260 <sup>d</sup>				$^\circ\text{C}$
Wave Soldering Temperature for 3s (2 mm distance from body)	250				$^\circ\text{C}$

- Duty factor = 10%, frequency = 1 kHz,  $T_A = 25^\circ\text{C}$ .
- Derate linearly as shown in [Figure 4](#) (deep red), [Figure 8](#) (red), [Figure 12](#) (yellow), and [Figure 16](#) (green).
- Reverse voltage is for LED testing purposes and is not recommended to be used as an application condition.
- Maximum tolerable component side temperature is  $134^\circ\text{C}$  during solder process.

## Electrical/Optical Characteristics ( $T_A = 25^\circ\text{C}$ )

**NOTE:** Electrical/optical characteristics of the Red elements of the HDSP-4832/-4836 are identical to the HDSP-4830 characteristics. Characteristics of Yellow elements of the HDSP-4832/-4836 are identical to the HDSP-4840. Characteristics of Green elements of the HDSP-4832/-4836 are identical to the HDSP-4850.

Parameter	Symbol	Min.	Typ.	Max.	Unit	Test Condition
<b>Deep Red, HLCP-J100</b>						
Luminous Intensity per LED (Unit Average) <sup>a, b</sup>	$I_V$	0.6	1.0	—	mcd	$I_F = 1 \text{ mA}$
Peak Wavelength	$\lambda_p$	—	656	—	nm	
Dominant Wavelength <sup>c</sup>	$\lambda_d$	—	639	—	nm	
Forward Voltage per LED <sup>d</sup>	$V_F$	—	2.1	2.5	V	$I_F = 20 \text{ mA}$
Reverse Voltage per LED <sup>e</sup>	$V_R$	5.0	—	—	V	$I_R = 100 \mu\text{A}$
<b>Red, HDSP-4830</b>						
Luminous Intensity per LED (Unit Average) <sup>a, b</sup>	$I_V$	1.37	8.40	—	mcd	$I_F = 10 \text{ mA}$
Peak Wavelength	$\lambda_p$	—	631	—	nm	
Dominant Wavelength <sup>c</sup>	$\lambda_d$	—	622	—	nm	
Forward Voltage per LED <sup>d</sup>	$V_F$	—	2.05	2.5	V	$I_F = 20 \text{ mA}$
Reverse Voltage per LED <sup>e</sup>	$V_R$	3.0	—	—	V	$I_R = 100 \mu\text{A}$

Parameter	Symbol	Min.	Typ.	Max.	Unit	Test Condition
<b>Yellow, HDSP-4840</b>						
Luminous Intensity per LED (Unit Average) <sup>a, b</sup>	$I_V$	0.91	4.90	—	mcd	$I_F = 10 \text{ mA}$
Peak Wavelength	$\lambda_p$	—	591	—	nm	
Dominant Wavelength <sup>c</sup>	$\lambda_d$	581	588	592	nm	
Forward Voltage per LED <sup>d</sup>	$V_F$	—	2.0	2.5	V	$I_F = 20 \text{ mA}$
Reverse Voltage per LED <sup>e</sup>	$V_R$	3.0	—	—	V	$I_R = 100 \mu\text{A}$
<b>Green, HDSP-4850</b>						
Luminous Intensity per LED (Unit Average) <sup>a, b</sup>	$I_V$	1.37	10.20	—	mcd	$I_F = 10 \text{ mA}$
Peak Wavelength	$\lambda_p$	—	572	—	nm	
Dominant Wavelength <sup>c</sup>	$\lambda_d$	—	571	577	nm	
Forward Voltage per LED <sup>d</sup>	$V_F$	—	2.1	2.5	V	$I_F = 10 \text{ mA}$
Reverse Voltage per LED <sup>e</sup>	$V_R$	3.0	—	—	V	$I_R = 100 \mu\text{A}$

- a. The luminous intensity,  $I_V$ , is measured at the mechanical axis of the package.
- b. The optical axis is closely aligned with the mechanical axis of the package.
- c. The dominant wavelength,  $\lambda_d$ , is derived from the CIE Chromaticity Diagram and represents the color of the device.
- d. Forward voltage tolerance is  $\pm 0.1\text{V}$ .
- e. Typical specification for reference only. Do not exceed absolute maximum ratings, and long-term reverse bias is not recommended.

## Intensity Bin Limits (mcd)

### Deep Red/Red/Yellow/Green

IV Bin Category	Min.	Max.
D <sup>a</sup>	0.61	1.11
E <sup>b</sup>	0.91	1.67
F <sup>c</sup>	1.37	2.51
G	2.05	3.76
H	3.08	5.64
I	4.62	8.64
J	6.93	12.70
K	10.39	19.04
L	15.58	28.56
M	23.36	42.85
N	35.05	64.26
O	52.28	96.39

- a. Minimum category D for Deep Red
- b. Minimum category E for Yellow
- c. Minimum category F for Red/Green

## Color Categories

Color	Bin	Dominant Wavelength (nm)	
		Min.	Max.
Yellow	1	581.50	585.00
	2	584.00	587.50
	3	586.50	590.00
	4	589.00	592.50
Green	2	573.00	577.00
	3	570.00	574.00
	4	567.00	571.00
	5	564.00	568.00

# Deep Red Graphs

Figure 1: Relative Intensity vs. Wavelength

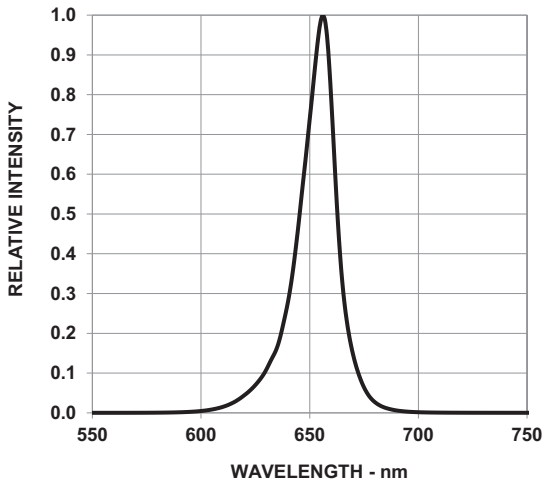

Figure 2: Forward Current vs. Forward Voltage

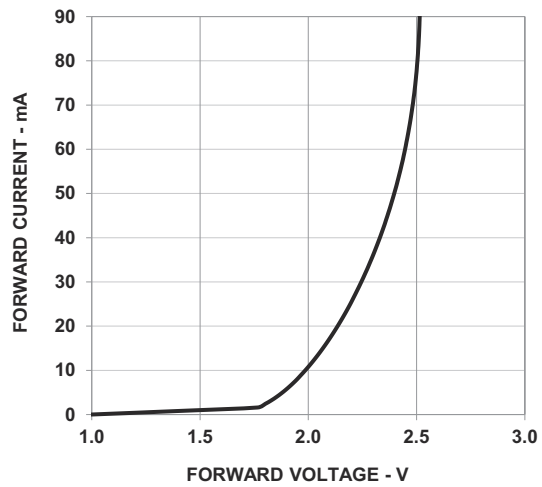

Figure 3: Relative Luminous Intensity vs. Forward Current

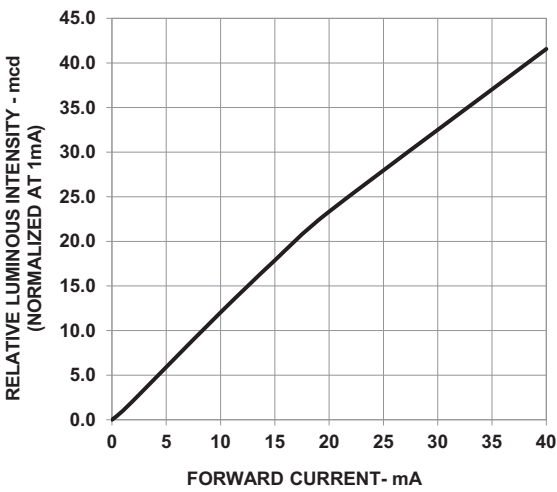
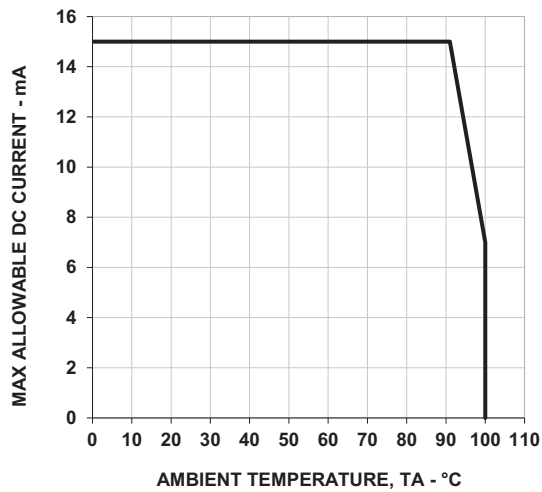

Figure 4: Maximum Forward Current vs. Ambient Temperature



# Red Graphs

Figure 5: Relative Intensity vs. Wavelength

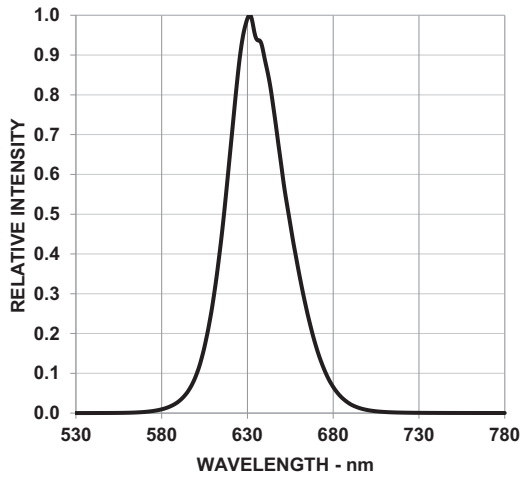

Figure 6: Forward Current vs. Forward Voltage

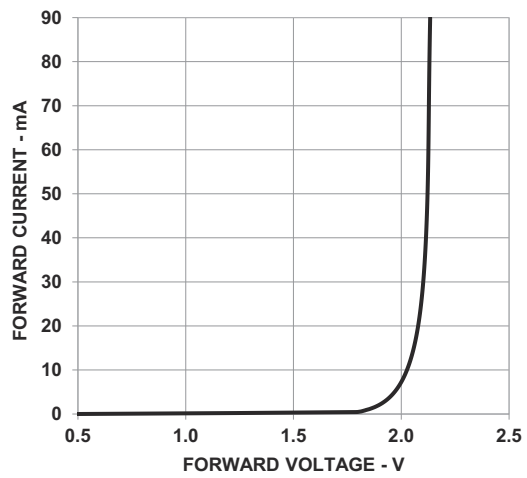

Figure 7: Relative Luminous Intensity vs. Forward Current

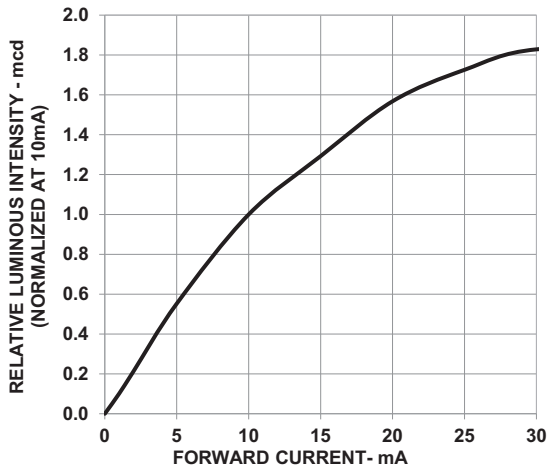
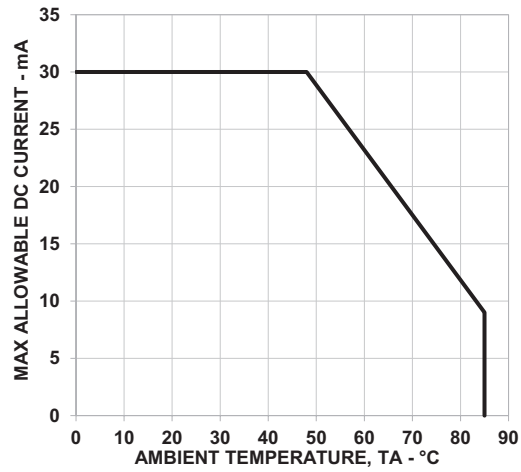

Figure 8: Maximum Forward Current vs. Ambient Temperature



# Yellow Graphs

Figure 9: Relative Intensity vs. Wavelength

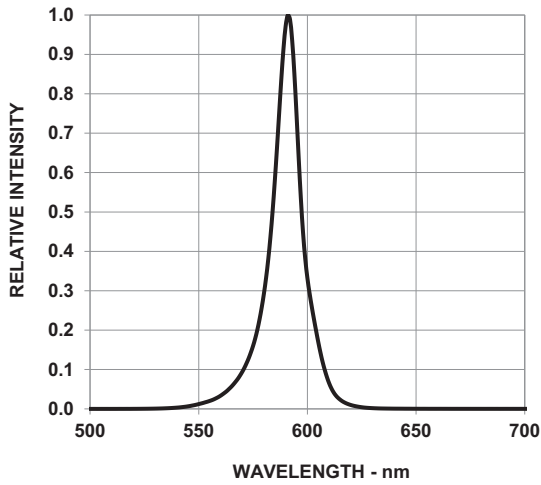

Figure 10: Forward Current vs. Forward Voltage

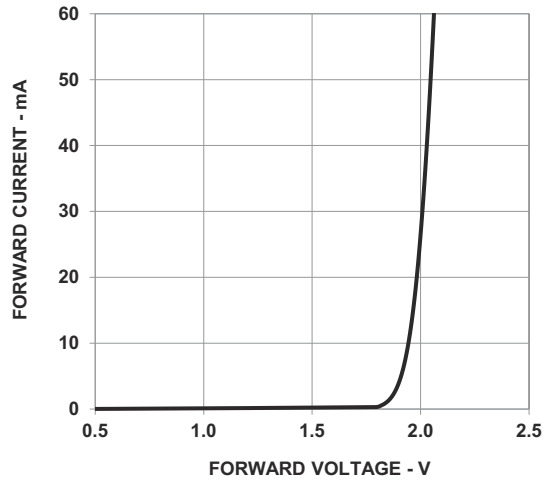

Figure 11: Relative Luminous Intensity vs. Forward Current

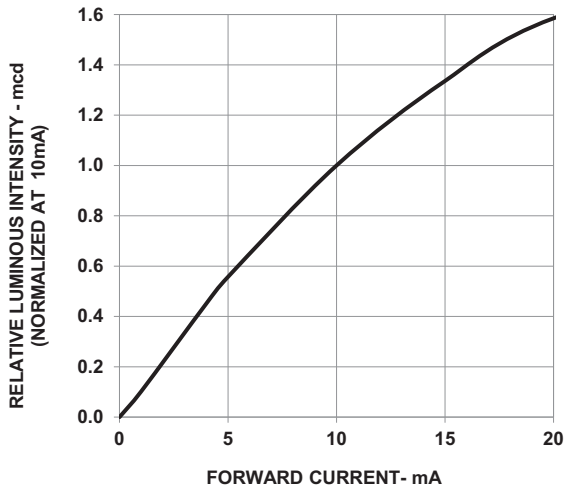
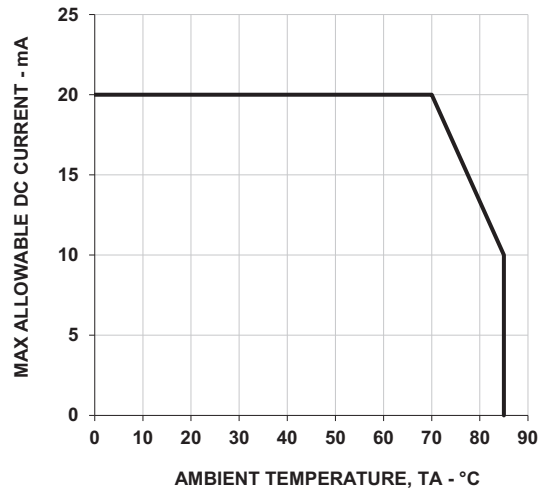

Figure 12: Maximum Forward Current vs. Ambient Temperature



# Green Graphs

Figure 13: Relative Intensity vs. Wavelength

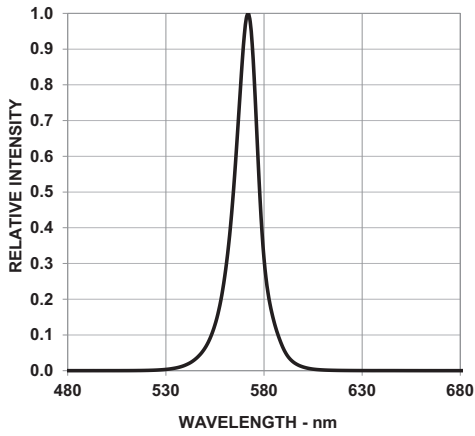

Figure 14: Forward Current vs. Forward Voltage

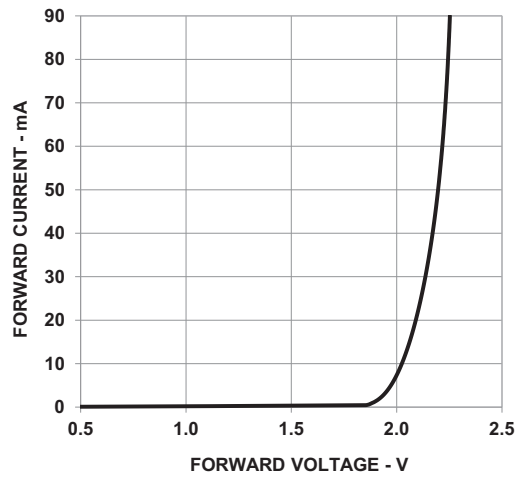

Figure 15: Relative Luminous Intensity vs. Forward Current

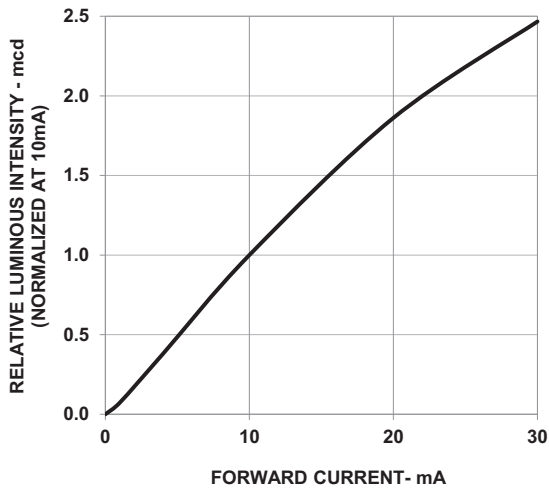
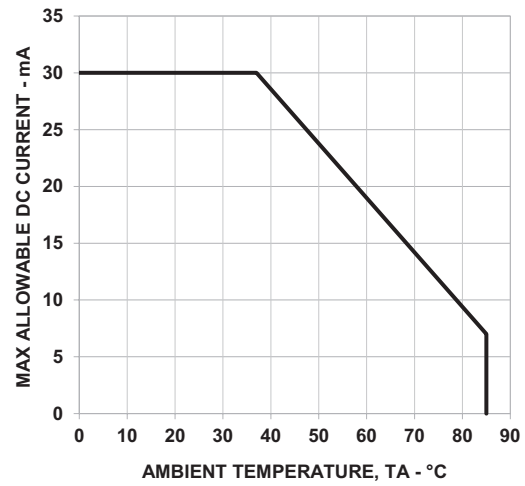

Figure 16: Maximum Forward Current vs. Ambient Temperature





## Precautionary Notes

### Soldering and Handling Precautions

- Set and maintain the wave soldering parameters according to the recommended temperature and dwell time. Perform daily checks on the profile to ensure that it is always conforming to the recommended conditions. Exceeding these conditions will over-stress the LEDs and cause premature failures.
- Use only bottom preheaters to reduce thermal stress experienced by the LEDs.
- Recalibrate the soldering profile before loading a new type of a PCB. PCBs with different sizes and designs (component density) will have different heat capacities and might cause a change in temperature experienced by the PCB if the same wave soldering setting is used.
- Do not perform wave soldering more than once.
- Any alignment fixture used during wave soldering must be loosely fitted and must not apply stress on the LEDs. Use non-metal material because it will absorb less heat during the wave soldering process.
- At elevated temperatures, the LEDs are more susceptible to mechanical stress. Allow the PCB to be sufficiently cooled to room temperature before handling. Do not apply stress to the LED when it is hot.
- Use wave soldering to solder the LED. Use hand soldering only for rework or touch up if unavoidable, but it must be strictly controlled to following conditions:
  - Soldering iron tip temperature = 315°C maximum.
  - Soldering duration = 2 seconds maximum.
  - Number of cycles = 1 only.
  - Power of soldering iron = 50W maximum.
- For ESD-sensitive devices, apply proper ESD precautions at the soldering station. Use only an ESD-safe soldering iron.
- Do not touch the LED package body with the soldering iron except for the soldering terminals because it may cause damage to the LED.
- Confirm beforehand whether the functionality and performance of the LED is affected by soldering with hand soldering.
- Keep the heat source at least 1.6 mm away from the LED body during soldering.
- Design an appropriate hole size to avoid problems during insertion.
- Cleaning agents from the ketone family (acetone, methyl ethylketone, and so on) and from the chlorinated hydrocarbon family (methylene chloride,

trichloroethylene, carbon tetrachloride, and so on) are not recommended for cleaning the LED displays. All of these various solvents attack or dissolve the encapsulating epoxies used to form the package of plastic LED parts.

- For the purpose of cleaning, wash with DI water only. The cleaning process should take place at room temperature only. Clear any water or moisture from the LED display immediately after washing.
- Use of *No clean* solder paste is recommended for soldering.

Figure 17: Recommended Wave Soldering Profile

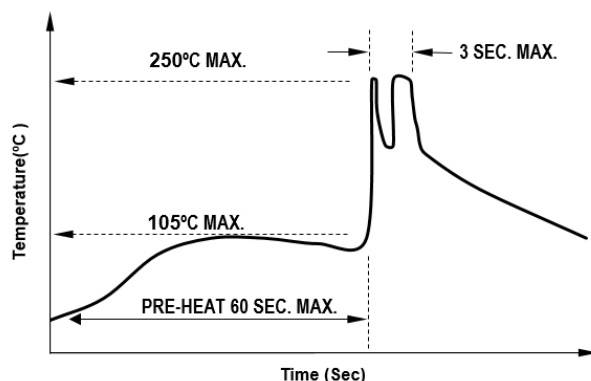

**NOTE:** Figure 17 refers to measurements with thermocouple mounted at the bottom of the PCB.

### Application Precautions

- The drive current of the LED must not exceed the maximum allowable limit across temperatures as stated in the data sheet. Constant current driving is recommended to ensure consistent performance.
- Circuit design must cater to the whole range of forward voltage ( $V_F$ ) of the LEDs to ensure the intended drive current can always be achieved.
- The LED exhibits slightly different characteristics at different drive currents, which may result in a larger variation of performance (such as intensity, wavelength, and forward voltage). Set the application current as close as possible to the test current to minimize these variations.
- The LED is not intended for reverse bias. Use other appropriate components for such purposes. When driving the LED in matrix form, ensure that the reverse bias voltage does not exceed the allowable limit of the LED.

- Avoid rapid change in ambient temperatures, especially in high-humidity environments, because they cause condensation on the LED.
- If the LED is intended to be used in a harsh or outdoor environment, protect the LED against damages caused by rain, water, dust, oil, corrosive gases, external mechanical stresses, and so on.

## Eye Safety Precautions

LEDs may pose optical hazards when in operation. Do not look directly at operating LEDs because it might be harmful to the eyes. For safety reasons, use appropriate shielding or personal protective equipment.