

HEF4069UB-Q100

Hex unbuffered inverter

Rev. 3 — 5 January 2022

Product data sheet

1. General description

The HEF4069UB-Q100 is a hex unbuffered inverter. Inputs include clamp diodes. This enables the use of current limiting resistors to interface inputs to voltages in excess of V_{DD} .

This product has been qualified to the Automotive Electronics Council (AEC) standard Q100 (Grade 1) and is suitable for use in automotive applications.

2. Features and benefits

- Automotive product qualification in accordance with AEC-Q100 (Grade 1)
 - Specified from -40 °C to +85 °C and from -40 °C to +125 °C
- Wide supply voltage range from 3.0 V to 15.0 V
- CMOS low power dissipation
- High noise immunity
- Fully static operation
- 5 V, 10 V, and 15 V parametric ratings
- Standardized symmetrical output characteristics
- Complies with JEDEC standard JESD 13-B
- ESD protection:
 - MIL-STD883, method 3015 exceeds 2000 V
 - HBM JESD22-A114F exceeds 2000 V
 - MM JESD22-A115-A exceeds 200 V (C = 200 pF, R = 0 Ω)

3. Applications

- Oscillator

4. Ordering information

Table 1. Ordering information

Type number	Package			
	Temperature range	Name	Description	Version
HEF4069UBT-Q100	-40 °C to +125 °C	SO14	plastic small outline package; 14 leads; body width 3.9 mm	SOT108-1
HEF4069UBTT-Q100	-40 °C to +125 °C	TSSOP14	plastic thin shrink small outline package; 14 leads; body width 4.4 mm	SOT402-1

5. Functional diagram

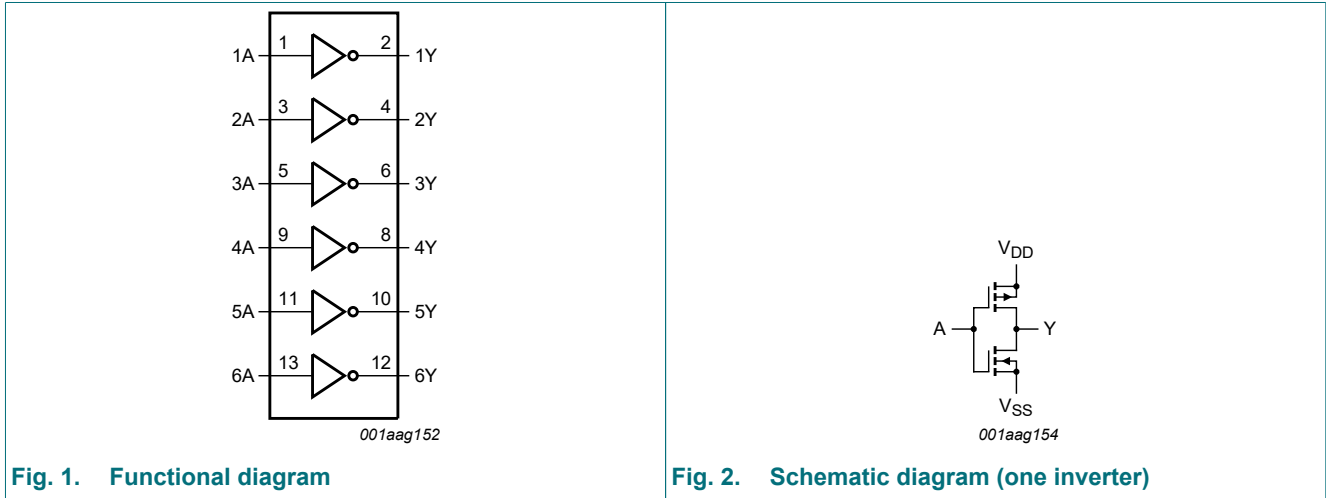

Fig. 1. Functional diagram

Fig. 2. Schematic diagram (one inverter)

6. Pinning information

6.1. Pinning

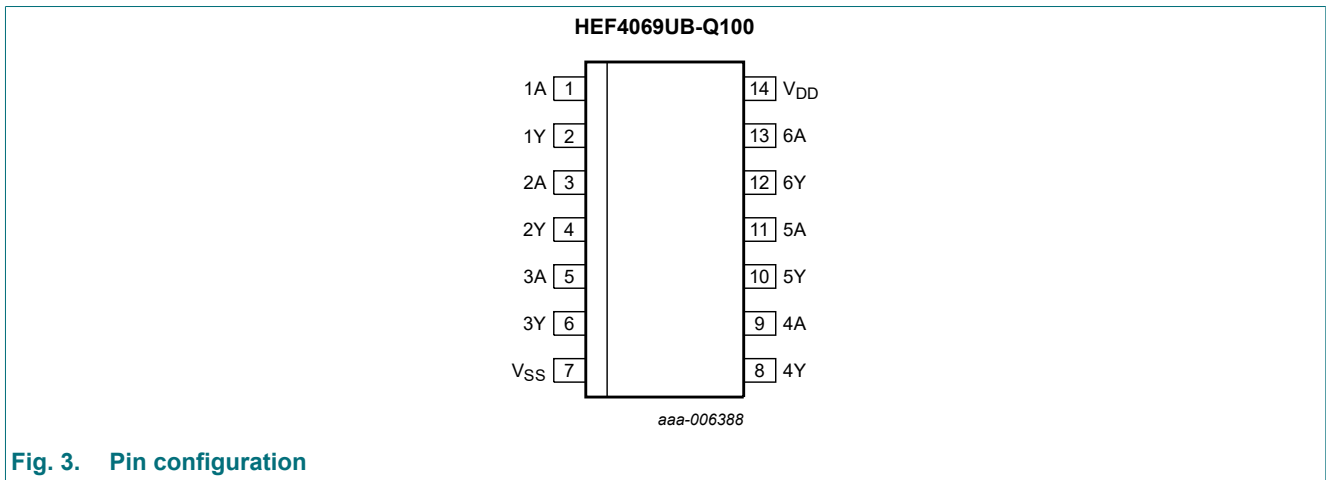

Fig. 3. Pin configuration

6.2. Pin description

Table 2. Pin description

Symbol	Pin	Description
1A, 2A, 3A, 4A, 5A, 6A	1, 3, 5, 9, 11, 13	input
1Y, 2Y, 3Y, 4Y, 5Y, 6Y	2, 4, 6, 8, 10, 12	output
V _{SS}	7	ground (0 V)
V _{DD}	14	supply voltage

7. Limiting values

Table 3. Limiting values

In accordance with the Absolute Maximum Rating System (IEC 60134).

Symbol	Parameter	Conditions	Min	Max	Unit
V_{DD}	supply voltage		-0.5	+18	V
I_{IK}	input clamping current	$V_I < -0.5\text{ V}$ or $V_I > V_{DD} + 0.5\text{ V}$	-	± 10	mA
V_I	input voltage		-0.5	$V_{DD} + 0.5$	V
I_{OK}	output clamping current	$V_O < -0.5\text{ V}$ or $V_O > V_{DD} + 0.5\text{ V}$	-	± 10	mA
$I_{I/O}$	input/output current		-	± 10	mA
I_{DD}	supply current		-	50	mA
T_{stg}	storage temperature		-65	+150	°C
T_{amb}	ambient temperature		-40	+125	°C
P_{tot}	total power dissipation	$T_{amb} = -40\text{ °C}$ to $+125\text{ °C}$ [1]	-	500	mW
P	power dissipation	per output	-	100	mW

[1] For SOT108-1 (SO14) package: P_{tot} derates linearly with 10.1 mW/K above 100 °C.
For SOT402-1 (TSSOP14) package: P_{tot} derates linearly with 7.3 mW/K above 81 °C.

8. Recommended operating conditions

Table 4. Recommended operating conditions

Symbol	Parameter	Conditions	Min	Typ	Max	Unit
V_{DD}	supply voltage		3	-	15	V
V_I	input voltage		0	-	V_{DD}	V
T_{amb}	ambient temperature	in free air	-40	-	+125	°C

9. Static characteristics

Table 5. Static characteristics

$V_{SS} = 0\text{ V}$; $V_I = V_{SS}$ or V_{DD} ; unless otherwise specified.

Symbol	Parameter	Conditions	V_{DD}	$T_{amb} = -40\text{ °C}$		$T_{amb} = +25\text{ °C}$		$T_{amb} = +85\text{ °C}$		$T_{amb} = +125\text{ °C}$		Unit
				Min	Max	Min	Max	Min	Max	Min	Max	
V_{IH}	HIGH-level input voltage	$ I_O < 1\text{ }\mu\text{A}$	5 V	4	-	4	-	4	-	4	-	V
			10 V	8	-	8	-	8	-	8	-	V
			15 V	12.5	-	12.5	-	12.5	-	12.5	-	V
V_{IL}	LOW-level input voltage	$ I_O < 1\text{ }\mu\text{A}$	5 V	-	1	-	1	-	1	-	1	V
			10 V	-	2	-	2	-	2	-	2	V
			15 V	-	2.5	-	2.5	-	2.5	-	2.5	V
V_{OH}	HIGH-level output voltage	$ I_O < 1\text{ }\mu\text{A}$	5 V	4.95	-	4.95	-	4.95	-	4.95	-	V
			10 V	9.95	-	9.95	-	9.95	-	9.95	-	V
			15 V	14.95	-	14.95	-	14.95	-	14.95	-	V
V_{OL}	LOW-level output voltage	$ I_O < 1\text{ }\mu\text{A}$	5 V	-	0.05	-	0.05	-	0.05	-	0.05	V
			10 V	-	0.05	-	0.05	-	0.05	-	0.05	V
			15 V	-	0.05	-	0.05	-	0.05	-	0.05	V

Symbol	Parameter	Conditions	V _{DD}	T _{amb} = -40 °C		T _{amb} = +25 °C		T _{amb} = +85 °C		T _{amb} = +125 °C		Unit
				Min	Max	Min	Max	Min	Max	Min	Max	
I _{OH}	HIGH-level output current	V _O = 2.5 V	5 V	-	-1.7	-	-1.4	-	-1.1	-	-1.1	mA
		V _O = 4.6 V	5 V	-	-0.64	-	-0.5	-	-0.36	-	-0.36	mA
		V _O = 9.5 V	10 V	-	-1.6	-	-1.3	-	-0.9	-	-0.9	mA
		V _O = 13.5 V	15 V	-	-4.2	-	-3.4	-	-2.4	-	-2.4	mA
I _{OL}	LOW-level output current	V _O = 0.4 V	5 V	0.64	-	0.5	-	0.36	-	0.36	-	mA
		V _O = 0.5 V	10 V	1.6	-	1.3	-	0.9	-	0.9	-	mA
		V _O = 1.5 V	15 V	4.2	-	3.4	-	2.4	-	2.4	-	mA
I _I	input leakage current		15 V	-	±0.1	-	±0.1	-	±1.0	-	±1.0	µA
I _{DD}	supply current	all valid input combinations; I _O = 0 A	5 V	-	0.25	-	0.25	-	7.5	-	7.5	µA
			10 V	-	0.5	-	0.5	-	15.0	-	15.0	µA
			15 V	-	1.0	-	1.0	-	30.0	-	30.0	µA
C _I	input capacitance	digital inputs		-	-	-	7.5	-	-	-	pF	

10. Dynamic characteristics

Table 6. Dynamic characteristics

T_{amb} = 25 °C; for waveforms see Fig. 4; for test circuit see Fig. 5.

Symbol	Parameter	Conditions	V _{DD}	Extrapolation formula [1]	Min	Typ	Max	Unit
t _{PHL}	HIGH to LOW propagation delay	nA to nY	5 V	18 ns + (0.55 ns/pF)C _L	-	45	90	ns
			10 V	9 ns + (0.23 ns/pF)C _L	-	20	40	ns
			15 V	7 ns + (0.16 ns/pF)C _L	-	15	25	ns
t _{PLH}	LOW to HIGH propagation delay	nA to nY	5 V	13 ns + (0.55 ns/pF)C _L	-	40	80	ns
			10 V	9 ns + (0.23 ns/pF)C _L	-	20	40	ns
			15 V	7 ns + (0.16 ns/pF)C _L	-	15	30	ns
t _{THL}	HIGH to LOW output transition time	output nY	5 V	10 ns + (1.00 ns/pF)C _L	-	60	120	ns
			10 V	9 ns + (0.42 ns/pF)C _L	-	30	60	ns
			15 V	6 ns + (0.28 ns/pF)C _L	-	20	40	ns
t _{TLH}	LOW to HIGH output transition time	output nY	5 V	10 ns + (1.00 ns/pF)C _L	-	60	120	ns
			10 V	9 ns + (0.42 ns/pF)C _L	-	30	60	ns
			15 V	6 ns + (0.28 ns/pF)C _L	-	20	40	ns

[1] The typical value of the propagation delay and output transition time can be calculated with the extrapolation formula (C_L in pF).

Table 7. Dynamic power dissipation

V_{SS} = 0 V; t_r = t_f ≤ 20 ns; T_{amb} = 25 °C.

Symbol	Parameter	V _{DD}	Typical formula	Where
P _D	dynamic power dissipation	5 V	P _D = 600 × f _i + Σ(f _o × C _L) × V _{DD} ² (µW)	f _i = input frequency in MHz; f _o = output frequency in MHz; C _L = output load capacitance in pF; Σ(f _o × C _L) = sum of the outputs; V _{DD} = supply voltage in V.
		10 V	P _D = 4000 × f _i + Σ(f _o × C _L) × V _{DD} ² (µW)	
		15 V	P _D = 22000 × f _i + Σ(f _o × C _L) × V _{DD} ² (µW)	

10.1. Waveforms and test circuit

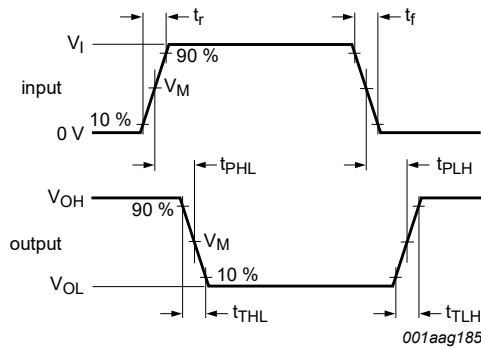

Measurement points: $V_M = 0.5V_{DD}$.
 Logic levels: V_{OL} and V_{OH} are typical output voltage levels that occur with the output load.

Fig. 4. Propagation delay and transition times

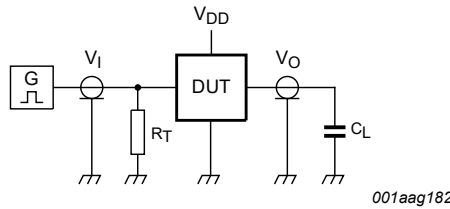

For test data refer to [Table 8](#).
 Definitions for test circuit:
 C_L = load capacitance including jig and probe capacitance;
 R_T = termination resistance should be equal to the output impedance Z_o of the pulse generator.

Fig. 5. Test circuit for measuring switching times

Table 8. Test data

Supply voltage	Input	Load
V_{DD}	V_I	C_L
5 V to 15 V	V_{SS} or V_{DD}	50 pF

10.2. Transfer characteristics

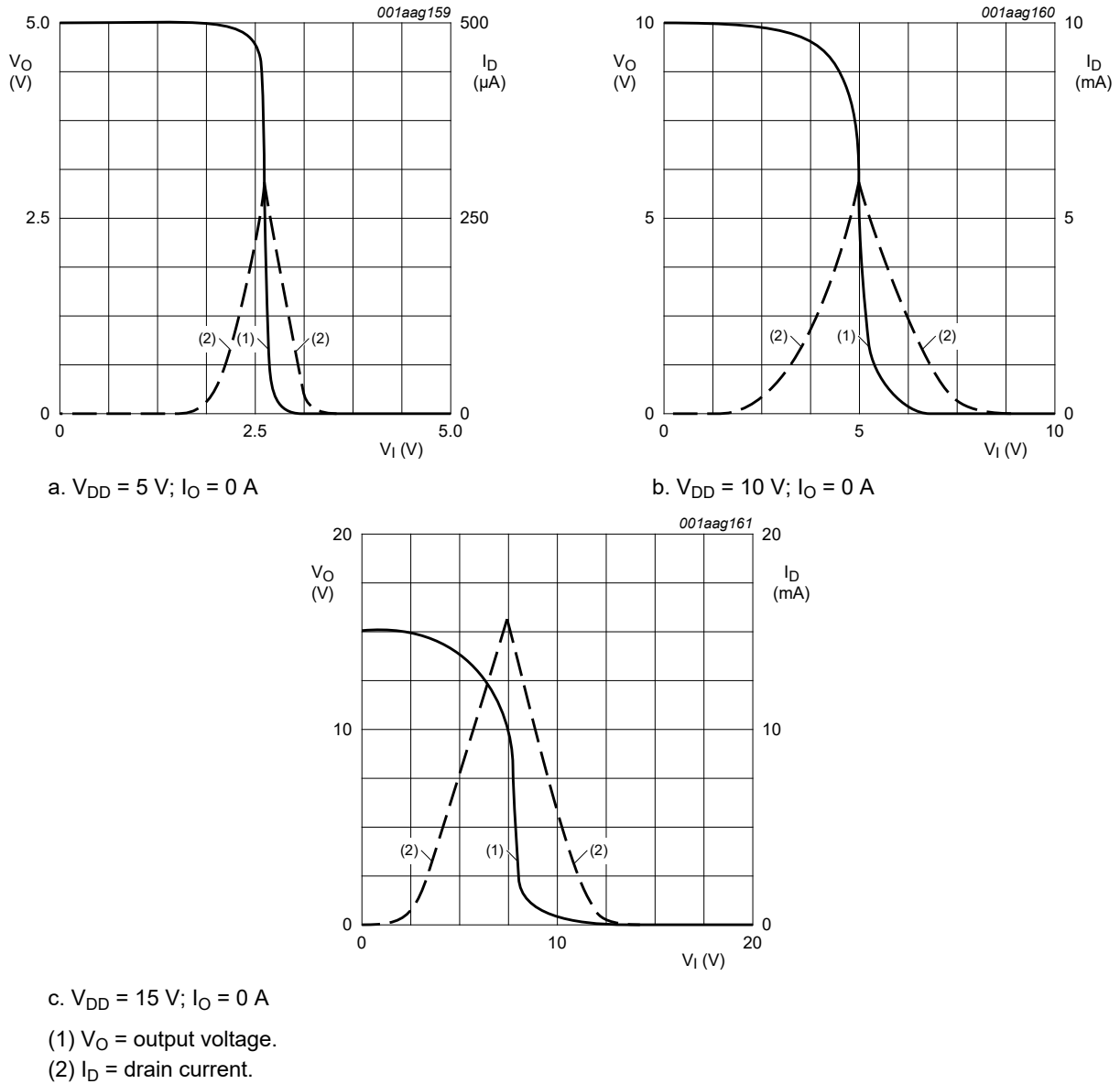

Fig. 6. Typical transfer characteristics

11. Application information

Some examples of applications for HEF4069UB-Q100.

Fig. 7 shows an astable relaxation oscillator using two HEF4069UB-Q100 inverters and two BAW62 diodes. The oscillation frequency is mainly determined by $R1 \times C1$, provided $R1 \ll R2$ and $R2 \times C2 \ll R1 \times C1$.

The function of $R2$ is to minimize the influence of the forward voltage across the protection diodes on the frequency; $C2$ is a stray (parasitic) capacitance.

The period T_p is given by $T_p = T_1 + T_2$,

where:

$$T_1 = R1C1 \ln \frac{V_{DD} + V_{ST}}{V_{ST}}$$

$$T_2 = R1C1 \ln \frac{2V_{DD} - V_{ST}}{V_{DD} - V_{ST}}$$

V_{ST} = the signal threshold level of the inverter.

The period is fairly independent of V_{DD} , V_{ST} and temperature. The duty factor, however, is influenced by V_{ST} .

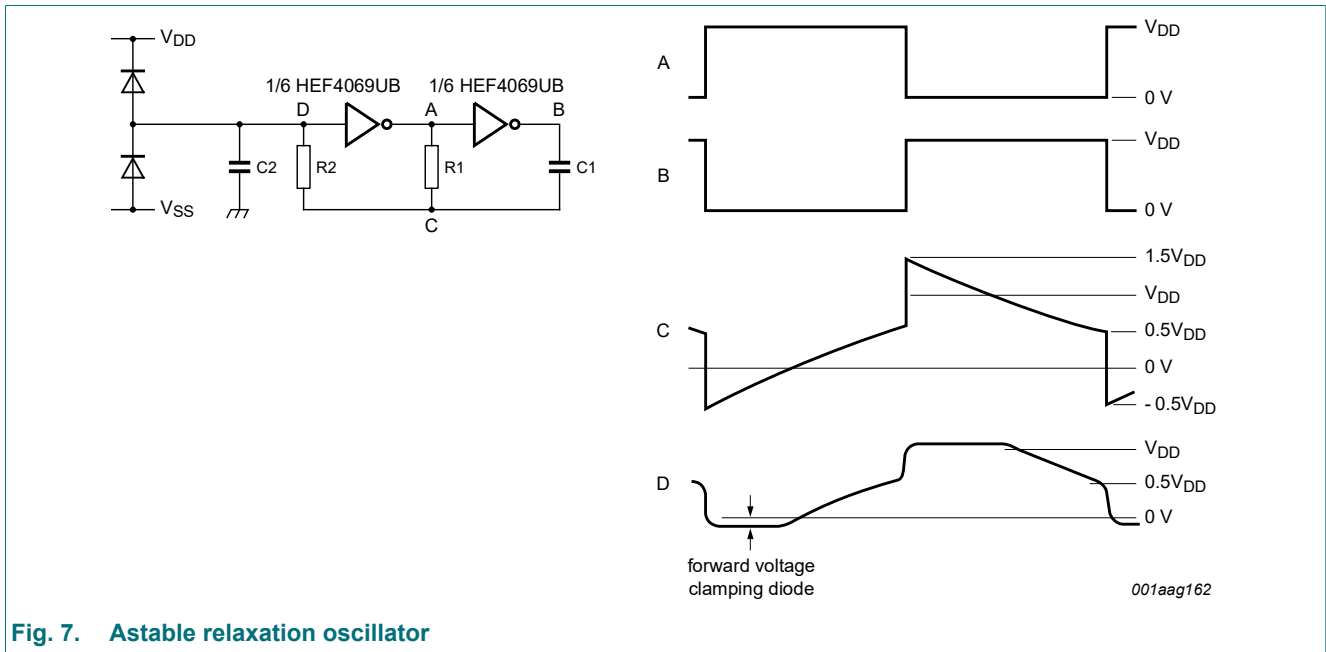
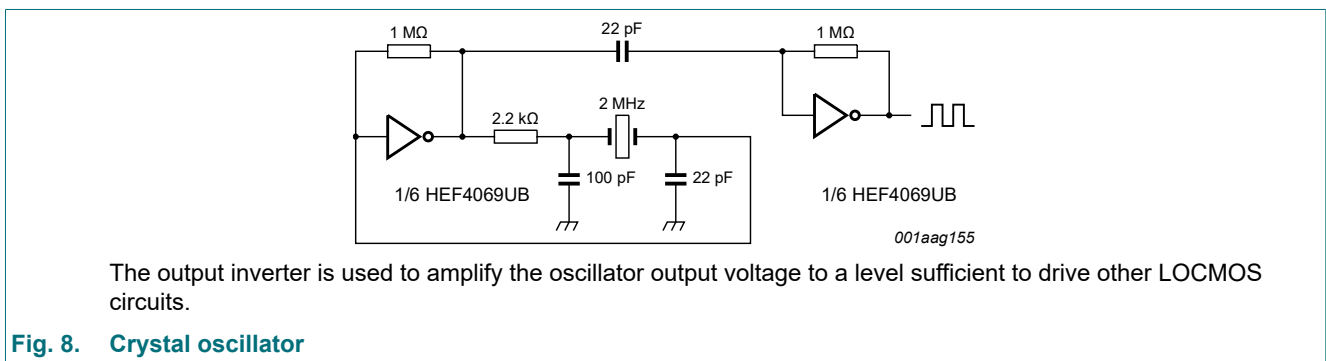

Fig. 7. Astable relaxation oscillator

Fig. 8 shows a crystal oscillator for frequencies up to 10 MHz using two HEF4069UB-Q100 inverters. The second inverter amplifies the oscillator output voltage to a level sufficient to drive other Local Oxidation CMOS (LOCMOS) circuits.



The output inverter is used to amplify the oscillator output voltage to a level sufficient to drive other LOCMOS circuits.

Fig. 8. Crystal oscillator

Fig. 9 and Fig. 10 show voltage gain and supply current. Fig. 11 shows the test set-up and an example of an analog amplifier using one HEF4069UB-Q100.

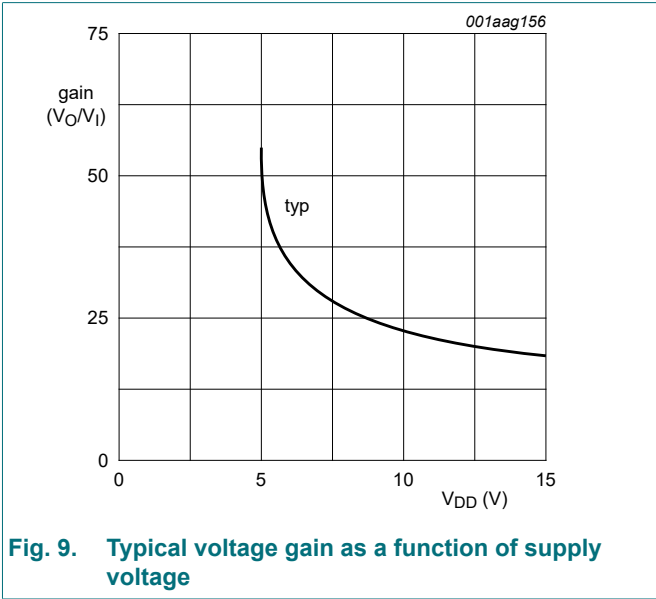

Fig. 9. Typical voltage gain as a function of supply voltage

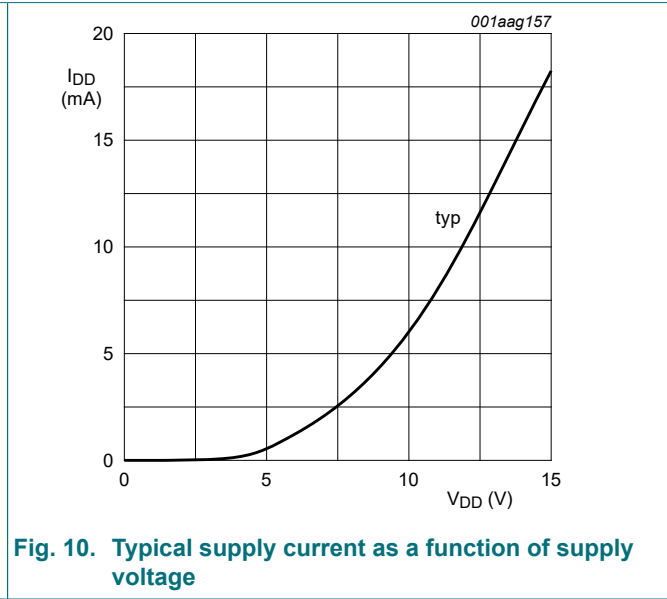

Fig. 10. Typical supply current as a function of supply voltage

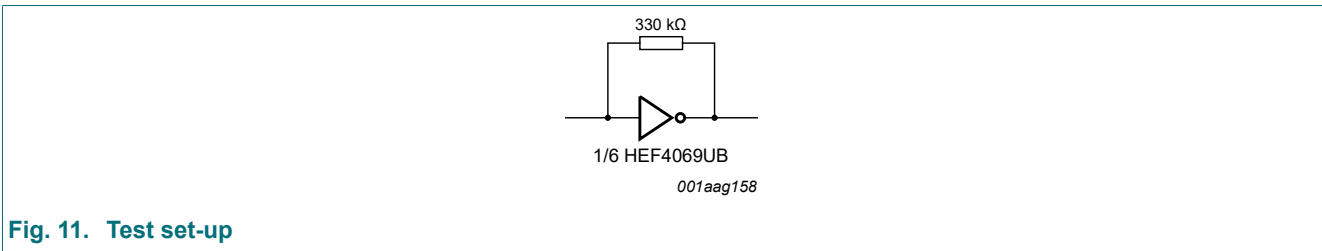

Fig. 11. Test set-up

Fig. 12 shows typical forward transconductance. Fig. 13 shows the test set-up.

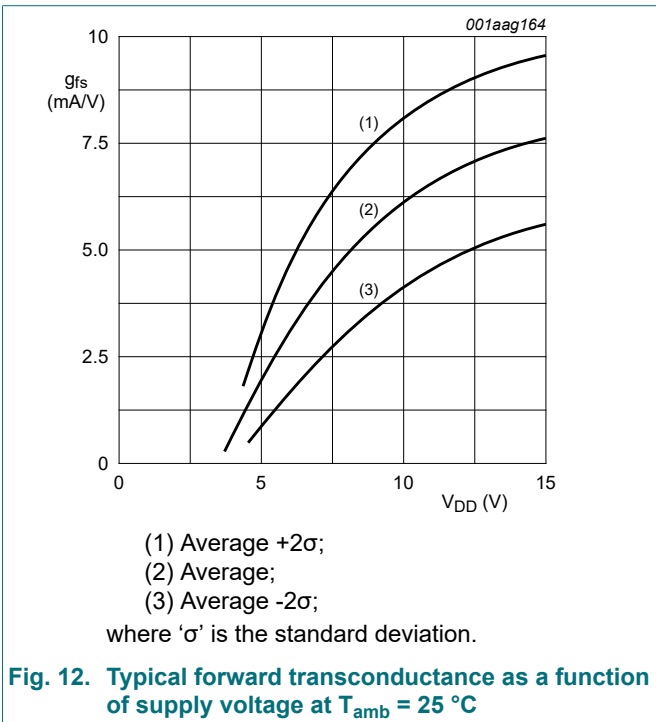

Fig. 12. Typical forward transconductance as a function of supply voltage at T_{amb} = 25 °C

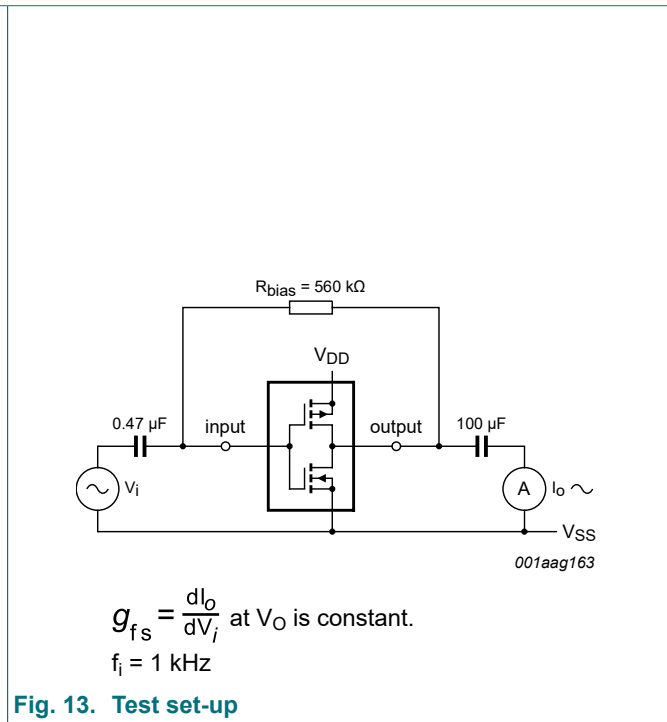

Fig. 13. Test set-up

12. Package outline

SO14: plastic small outline package; 14 leads; body width 3.9 mm

SOT108-1

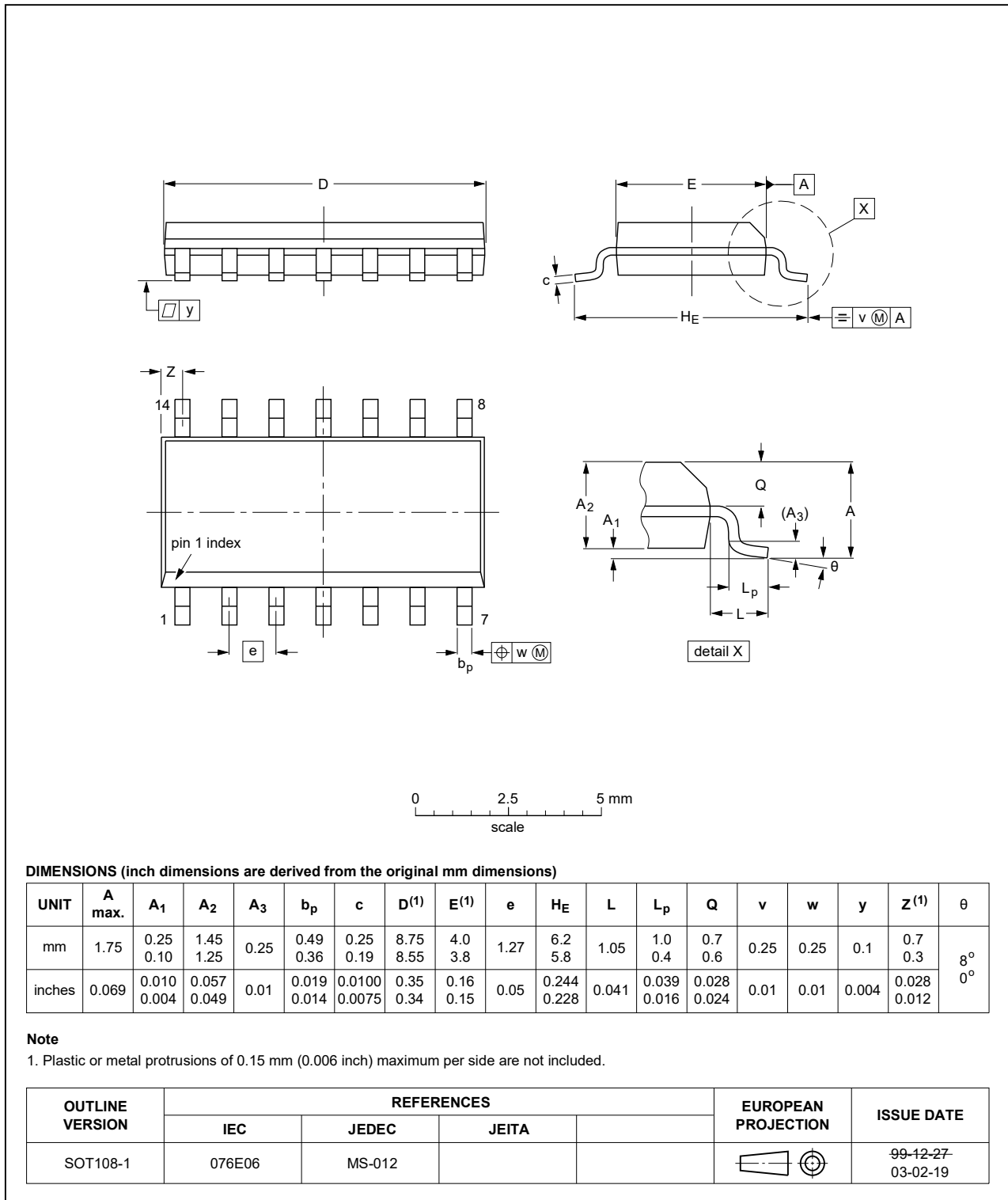

Fig. 14. Package outline SOT108-1 (SO14)

TSSOP14: plastic thin shrink small outline package; 14 leads; body width 4.4 mm

SOT402-1

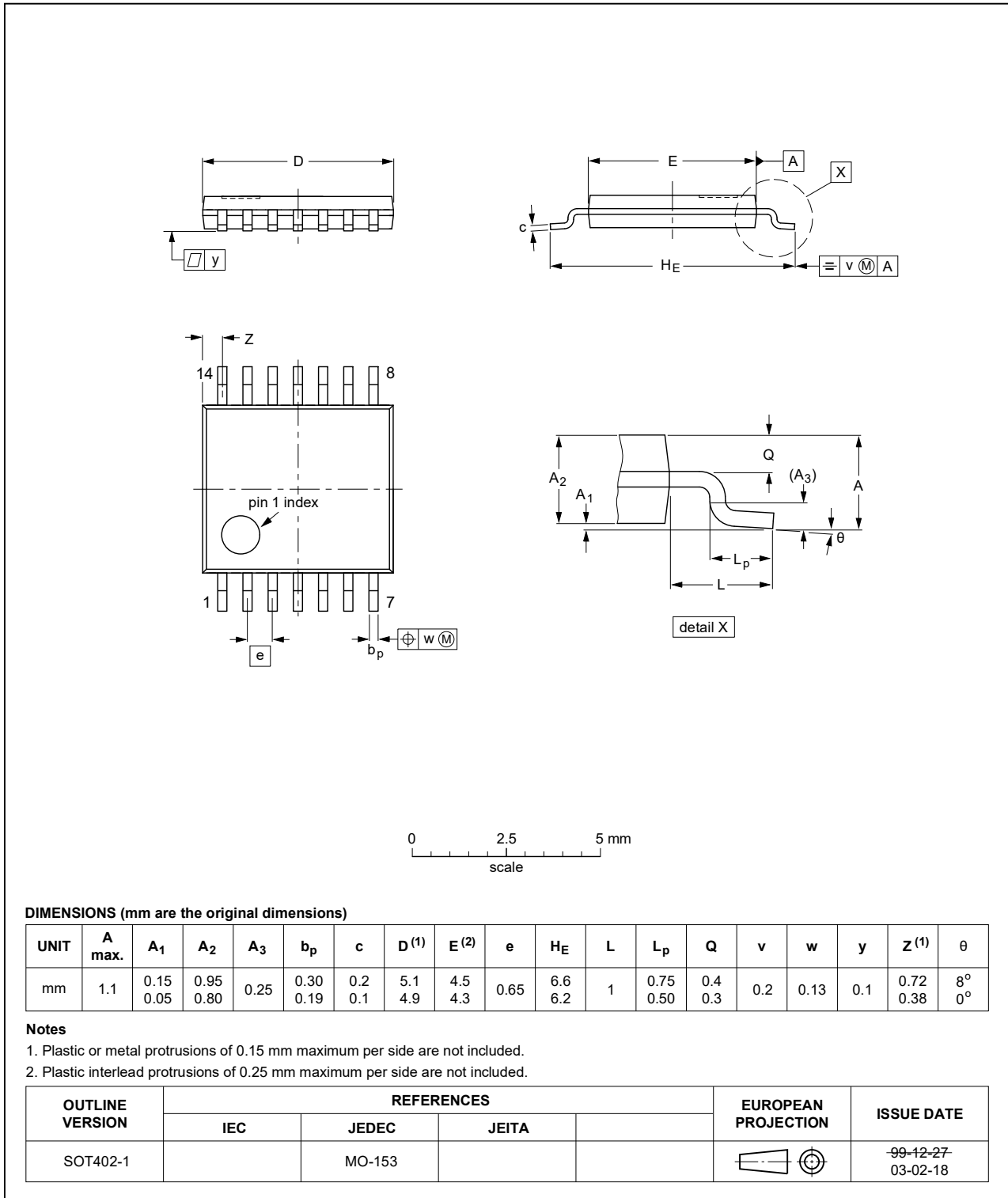

Fig. 15. Package outline SOT402-1 (TSSOP14)

13. Abbreviations

Table 9. Abbreviations

Acronym	Description
CMOS	Complementary Metal-Oxide Semiconductor
DUT	Device Under Test
ESD	ElectroStatic Discharge
HBM	Human Body Model
LOC MOS	Local Oxidation Complementary Metal-Oxide Semiconductor
MIL	Military
MM	Machine Model

14. Revision history

Table 10. Revision history

Document ID	Release date	Data sheet status	Change notice	Supersedes
HEF4069UB_Q100 v.3	20220106	Product data sheet	-	HEF4069UB_Q100 v.2
Modifications:	<ul style="list-style-type: none"> The format of this data sheet has been redesigned to comply with the identity guidelines of Nexperia. Legal texts have been adapted to the new company name where appropriate. Section 1 and Section 2 updated. Table 3: Derating values for P_{tot} total power dissipation updated. 			
HEF4069UB_Q100 v.2	20140909	Product data sheet	-	HEF4069UB_Q100 v.1
Modifications:	<ul style="list-style-type: none"> : ESD protection: MIL-STD-833 changed to MIL-STD883 			
HEF4069UB_Q100 v.1	20130228	Product data sheet	-	-

15. Legal information

Data sheet status

Document status [1][2]	Product status [3]	Definition
Objective [short] data sheet	Development	This document contains data from the objective specification for product development.
Preliminary [short] data sheet	Qualification	This document contains data from the preliminary specification.
Product [short] data sheet	Production	This document contains the product specification.

- [1] Please consult the most recently issued document before initiating or completing a design.
- [2] The term 'short data sheet' is explained in section "Definitions".
- [3] The product status of device(s) described in this document may have changed since this document was published and may differ in case of multiple devices. The latest product status information is available on the internet at <https://www.nexperia.com>.

Definitions

Draft — The document is a draft version only. The content is still under internal review and subject to formal approval, which may result in modifications or additions. Nexperia does not give any representations or warranties as to the accuracy or completeness of information included herein and shall have no liability for the consequences of use of such information.

Short data sheet — A short data sheet is an extract from a full data sheet with the same product type number(s) and title. A short data sheet is intended for quick reference only and should not be relied upon to contain detailed and full information. For detailed and full information see the relevant full data sheet, which is available on request via the local Nexperia sales office. In case of any inconsistency or conflict with the short data sheet, the full data sheet shall prevail.

Product specification — The information and data provided in a Product data sheet shall define the specification of the product as agreed between Nexperia and its customer, unless Nexperia and customer have explicitly agreed otherwise in writing. In no event however, shall an agreement be valid in which the Nexperia product is deemed to offer functions and qualities beyond those described in the Product data sheet.

Disclaimers

Limited warranty and liability — Information in this document is believed to be accurate and reliable. However, Nexperia does not give any representations or warranties, expressed or implied, as to the accuracy or completeness of such information and shall have no liability for the consequences of use of such information. Nexperia takes no responsibility for the content in this document if provided by an information source outside of Nexperia.

In no event shall Nexperia be liable for any indirect, incidental, punitive, special or consequential damages (including - without limitation - lost profits, lost savings, business interruption, costs related to the removal or replacement of any products or rework charges) whether or not such damages are based on tort (including negligence), warranty, breach of contract or any other legal theory.

Notwithstanding any damages that customer might incur for any reason whatsoever, Nexperia's aggregate and cumulative liability towards customer for the products described herein shall be limited in accordance with the Terms and conditions of commercial sale of Nexperia.

Right to make changes — Nexperia reserves the right to make changes to information published in this document, including without limitation specifications and product descriptions, at any time and without notice. This document supersedes and replaces all information supplied prior to the publication hereof.

Suitability for use in automotive applications — This Nexperia product has been qualified for use in automotive applications. Unless otherwise agreed in writing, the product is not designed, authorized or warranted to be suitable for use in life support, life-critical or safety-critical systems or

equipment, nor in applications where failure or malfunction of an Nexperia product can reasonably be expected to result in personal injury, death or severe property or environmental damage. Nexperia and its suppliers accept no liability for inclusion and/or use of Nexperia products in such equipment or applications and therefore such inclusion and/or use is at the customer's own risk.

Quick reference data — The Quick reference data is an extract of the product data given in the Limiting values and Characteristics sections of this document, and as such is not complete, exhaustive or legally binding.

Applications — Applications that are described herein for any of these products are for illustrative purposes only. Nexperia makes no representation or warranty that such applications will be suitable for the specified use without further testing or modification.

Customers are responsible for the design and operation of their applications and products using Nexperia products, and Nexperia accepts no liability for any assistance with applications or customer product design. It is customer's sole responsibility to determine whether the Nexperia product is suitable and fit for the customer's applications and products planned, as well as for the planned application and use of customer's third party customer(s). Customers should provide appropriate design and operating safeguards to minimize the risks associated with their applications and products.

Nexperia does not accept any liability related to any default, damage, costs or problem which is based on any weakness or default in the customer's applications or products, or the application or use by customer's third party customer(s). Customer is responsible for doing all necessary testing for the customer's applications and products using Nexperia products in order to avoid a default of the applications and the products or of the application or use by customer's third party customer(s). Nexperia does not accept any liability in this respect.

Limiting values — Stress above one or more limiting values (as defined in the Absolute Maximum Ratings System of IEC 60134) will cause permanent damage to the device. Limiting values are stress ratings only and (proper) operation of the device at these or any other conditions above those given in the Recommended operating conditions section (if present) or the Characteristics sections of this document is not warranted. Constant or repeated exposure to limiting values will permanently and irreversibly affect the quality and reliability of the device.

Terms and conditions of commercial sale — Nexperia products are sold subject to the general terms and conditions of commercial sale, as published at <http://www.nexperia.com/profile/terms>, unless otherwise agreed in a valid written individual agreement. In case an individual agreement is concluded only the terms and conditions of the respective agreement shall apply. Nexperia hereby expressly objects to applying the customer's general terms and conditions with regard to the purchase of Nexperia products by customer.

No offer to sell or license — Nothing in this document may be interpreted or construed as an offer to sell products that is open for acceptance or the grant, conveyance or implication of any license under any copyrights, patents or other industrial or intellectual property rights.

Export control — This document as well as the item(s) described herein may be subject to export control regulations. Export might require a prior authorization from competent authorities.

Translations — A non-English (translated) version of a document is for reference only. The English version shall prevail in case of any discrepancy between the translated and English versions.

Trademarks

Notice: All referenced brands, product names, service names and trademarks are the property of their respective owners.