

HFA1130

850MHz, Output Limiting, Low Distortion Current Feedback Operational Amplifier

FN3369
Rev 5.00
April 25, 2013

The HFA1130 is a high speed wideband current feedback amplifier featuring programmable output limits. Built with Intersil's proprietary complementary bipolar UHF-1 process, it is the fastest monolithic amplifier available from any semiconductor manufacturer.

This amplifier is the ideal choice for high frequency applications requiring output limiting, especially those needing ultra fast overdrive recovery times. The output limiting function allows the designer to set the maximum positive and negative output levels, thereby protecting later stages from damage or input saturation. The sub-nanosecond overdrive recovery time quickly returns the amplifier to linear operation, following an overdrive condition.

The HFA1130 offers significant performance improvements over the CLC500/501/502.

Ordering Information

| PART NUMBER (Note) | PART MARKING | TEMP. RANGE (°C) | PACKAGE (Pb-free) | PKG. DWG. # |
|-----------------------|---------------------------------------------|---------------------|----------------------|-------------|
| HFA1130IBZ | 1130 IBZ | -40 to +85 | 8 Ld SOIC | M8.15 |
| HFA1130IBZ-T | 1130 IBZ | -40 to +85 | 8 Ld SOIC | M8.15 |
| HFA11XXEVAL | DIP Evaluation Board for High-Speed Op Amps | | | |

NOTE: Intersil Pb-free plus anneal products employ special Pb-free material sets; molding compounds/die attach materials and 100% matte tin plate termination finish, which are RoHS compliant and compatible with both SnPb and Pb-free soldering operations. Intersil Pb-free products are MSL classified at Pb-free peak reflow temperatures that meet or exceed the Pb-free requirements of IPC/JEDEC J STD-020.

The Op Amps with Fastest Edges

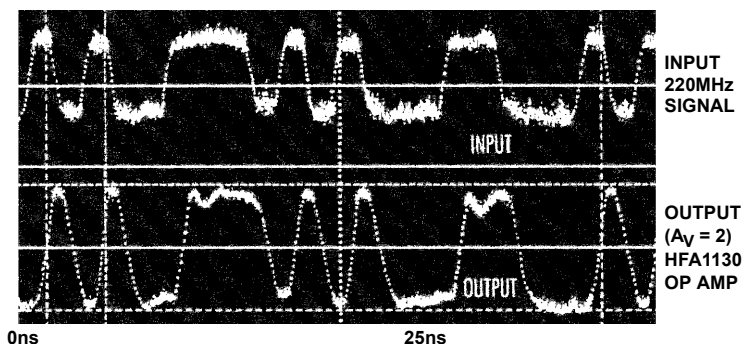

Features

- User Programmable Output Voltage Limits
- Low Distortion (30MHz, HD2) -56dBc
- -3dB Bandwidth 850MHz
- Very Fast Slew Rate. 2300V/μs
- Fast Settling Time (0.1%) 11ns
- Excellent Gain Flatness
 - (100MHz) 0.14dB
 - (50MHz) 0.04dB
 - (30MHz) 0.01dB
- High Output Current. 60mA
- Overdrive Recovery <1ns
- Pb-Free (RoHS Compliant)

Applications

- Residue Amplifier
- Video Switching and Routing
- Pulse and Video Amplifiers
- Wideband Amplifiers
- RF/IF Signal Processing
- Flash A/D Driver
- Medical Imaging Systems
- Related Literature
 - AN9420, Current Feedback Theory
 - AN9202, HFA11XX Evaluation Fixture

Pinout

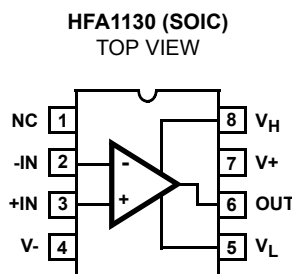

Absolute Maximum Ratings $T_A = +25^\circ\text{C}$

| | |
|---------------------------------------|---------------------|
| Voltage Between V+ and V-..... | 12V |
| Input Voltage | V_{SUPPLY} |
| Differential Input Voltage | 5V |
| Output Current (50% Duty Cycle) | 60mA |

Thermal Information

| | | |
|-----------------------------------------------------|-------------------------------------------------------|----------------------------------------------------|
| Thermal Resistance (Typical, Note 1) | θ_{JA} ($^\circ\text{C}/\text{W}$) | θ_{JC} ($^\circ\text{C}/\text{W}$) |
| SOIC Package | 170 | N/A |
| Maximum Junction Temperature (Plastic Package)..... | 150 $^\circ\text{C}$ | |
| Maximum Storage Temperature Range..... | -65 $^\circ\text{C}$ to T_A to 150 $^\circ\text{C}$ | |
| Pb-Free Reflow Profile see link below | | |

<http://www.intersil.com/pbfree/Pb-FreeReflow.asp>

Operating Conditions

Temperature Range.....-40 $^\circ\text{C}$ to 85 $^\circ\text{C}$

CAUTION: Stresses above those listed in "Absolute Maximum Ratings" may cause permanent damage to the device. This is a stress only rating and operation of the device at these or any other conditions above those indicated in the operational sections of this specification is not implied.

NOTE:

- θ_{JA} is measured with the component mounted on an evaluation PC board in free air.

Electrical Specifications $V_{\text{SUPPLY}} = \pm 5\text{V}$, $A_V = +1$, $R_F = 510\Omega$, $R_L = 100\Omega$, Unless Otherwise Specified

| PARAMETER | TEST CONDITIONS | TEST LEVEL (Note 2) | TEMP. ($^\circ\text{C}$) | MIN | TYP | MAX | UNITS |
|-------------------------------------------------------------------------|------------------------------------------|---------------------|----------------------------|-----------|-----------|-----|------------------------------|
| INPUT CHARACTERISTICS | | | | | | | |
| Input Offset Voltage (Note 3) | | A | +25 | - | 2 | 6 | mV |
| | | A | Full | - | - | 10 | mV |
| Input Offset Voltage Drift | | C | Full | - | 10 | - | $\mu\text{V}/^\circ\text{C}$ |
| V_{IO} CMRR | $\Delta V_{\text{CM}} = \pm 2\text{V}$ | A | +25 | 40 | 46 | - | dB |
| | | A | Full | 38 | - | - | dB |
| V_{IO} PSRR | $\Delta V_{\text{S}} = \pm 1.25\text{V}$ | A | +25 | 45 | 50 | - | dB |
| | | A | Full | 42 | - | - | dB |
| Non-Inverting Input Bias Current (Note 3) | +IN = 0V | A | +25 | - | 25 | 40 | μA |
| | | A | Full | - | - | 65 | μA |
| +IBIAS Drift | | C | Full | - | 40 | - | $\text{nA}/^\circ\text{C}$ |
| +IBIAS CMS | $\Delta V_{\text{CM}} = \pm 2\text{V}$ | A | +25 | - | 20 | 40 | $\mu\text{A}/\text{V}$ |
| | | A | Full | - | - | 50 | $\mu\text{A}/\text{V}$ |
| Inverting Input Bias Current (Note 3) | -IN = 0V | A | +25 | - | 12 | 50 | μA |
| | | A | Full | - | - | 60 | μA |
| -IBIAS Drift | | C | Full | - | 40 | - | $\text{nA}/^\circ\text{C}$ |
| -IBIAS CMS | $\Delta V_{\text{CM}} = \pm 2\text{V}$ | A | +25 | - | 1 | 7 | $\mu\text{A}/\text{V}$ |
| | | A | Full | - | - | 10 | $\mu\text{A}/\text{V}$ |
| -IBIAS PSS | $\Delta V_{\text{S}} = \pm 1.25\text{V}$ | A | +25 | - | 6 | 15 | $\mu\text{A}/\text{V}$ |
| | | A | Full | - | - | 27 | $\mu\text{A}/\text{V}$ |
| Non-Inverting Input Resistance | | A | +25 | 25 | 50 | - | $\text{k}\Omega$ |
| Inverting Input Resistance | | C | +25 | - | 20 | 30 | Ω |
| Input Capacitance (Either Input) | | B | +25 | - | 2 | - | pF |
| Input Common Mode Range | | C | Full | ± 2.5 | ± 3.0 | - | V |
| Input Noise Voltage (Note 3) | 100kHz | B | +25 | - | 4 | - | $\text{nV}/\sqrt{\text{Hz}}$ |
| +Input Noise Current (Note 3) | 100kHz | B | +25 | - | 18 | - | $\text{pA}/\sqrt{\text{Hz}}$ |
| -Input Noise Current (Note 3) | 100kHz | B | +25 | - | 21 | - | $\text{pA}/\sqrt{\text{Hz}}$ |
| TRANSFER CHARACTERISTICS $A_V = +2$, Unless Otherwise Specified | | | | | | | |
| Open Loop Transimpedance (Note 3) | | B | +25 | - | 300 | - | $\text{k}\Omega$ |

Electrical Specifications $V_{SUPPLY} = \pm 5V$, $A_V = +1$, $R_F = 510\Omega$, $R_L = 100\Omega$, Unless Otherwise Specified (Continued)

| PARAMETER | TEST CONDITIONS | TEST LEVEL (Note 2) | TEMP. (°C) | MIN | TYP | MAX | UNITS |
|-----------------------------------------------------------------------------------------------------|----------------------------------------------------------|---------------------|------------|-----------|------------|-----------|------------|
| -3dB Bandwidth (Note 3) | $V_{OUT} = 0.2V_{P-P}$ $A_V = +1$ | B | +25 | 530 | 850 | - | MHz |
| -3dB Bandwidth | $V_{OUT} = 0.2V_{P-P}$ $A_V = +2$, $R_F = 360\Omega$ | B | +25 | - | 670 | - | MHz |
| Full Power Bandwidth | $4V_{P-P}$, $A_V = -1$ | B | Full | - | 300 | - | MHz |
| Gain Flatness (Note 3) | To 100MHz | B | +25 | - | ± 0.14 | - | dB |
| Gain Flatness | To 50MHz | B | +25 | - | ± 0.04 | - | dB |
| Gain Flatness | To 30MHz | B | +25 | - | ± 0.01 | - | dB |
| Linear Phase Deviation (Note 3) | DC to 100MHz | B | +25 | - | 0.6 | - | ° |
| Differential Gain | NTSC, $R_L = 75\Omega$ | B | +25 | - | 0.03 | - | % |
| Differential Phase | NTSC, $R_L = 75\Omega$ | B | +25 | - | 0.05 | - | ° |
| Minimum Stable Gain | | A | Full | 1 | - | - | V/V |
| OUTPUT CHARACTERISTICS $A_V = +2$, Unless Otherwise Specified | | | | | | | |
| Output Voltage (Note 3) | $A_V = -1$ | A | +25 | ± 3.0 | ± 3.3 | - | V |
| | | A | Full | ± 2.5 | ± 3.0 | - | V |
| Output Current | $R_L = 50\Omega$, $A_V = -1$ | A | +25, +85 | 50 | 60 | - | mA |
| | | A | -40 | 35 | 50 | - | mA |
| DC Closed Loop Output Impedance (Note 3) | | B | +25 | - | 0.07 | - | Ω |
| 2nd Harmonic Distortion (Note 3) | 30MHz, $V_{OUT} = 2V_{P-P}$ | B | +25 | - | -56 | - | dBc |
| 3rd Harmonic Distortion (Note 3) | 30MHz, $V_{OUT} = 2V_{P-P}$ | B | +25 | - | -80 | - | dBc |
| 3rd Order Intercept (Note 3) | 100MHz | B | +25 | 20 | 30 | - | dBm |
| 1dB Compression | 100MHz | B | +25 | 15 | 20 | - | dBm |
| TRANSIENT RESPONSE $A_V = +2$, Unless Otherwise Specified | | | | | | | |
| Rise Time | $V_{OUT} = 2.0V$ Step | B | +25 | - | 900 | - | ps |
| Overshoot (Note 3) | $V_{OUT} = 2.0V$ Step | B | +25 | - | 10 | - | % |
| Slew Rate | $A_V = +1$, $V_{OUT} = 5V_{P-P}$ | B | +25 | - | 1400 | - | V/ μ s |
| | $A_V = +2$, $V_{OUT} = 5V_{P-P}$ | B | +25 | 1850 | 2300 | - | V/ μ s |
| 0.1% Settling Time (Note 3) | $V_{OUT} = 2V$ to $0V$ | B | +25 | - | 11 | - | ns |
| 0.2% Settling Time (Note 3) | $V_{OUT} = 2V$ to $0V$ | B | +25 | - | 7 | - | ns |
| POWER SUPPLY CHARACTERISTICS | | | | | | | |
| Supply Voltage Range | | B | Full | ± 4.5 | - | ± 5.5 | V |
| Supply Current (Note 3) | | A | +25 | - | 21 | 26 | mA |
| | | A | Full | - | - | 33 | mA |
| LIMITING CHARACTERISTICS $A_V = +2$, $V_H = +1V$, $V_L = -1V$, Unless Otherwise Specified | | | | | | | |
| Clamp Accuracy | $V_{IN} = \pm 2V$, $A_V = -1$ | A | +25 | - | 60 | ± 125 | mV |
| Clamped Overshoot | $V_{IN} = \pm 1V$, Input $t_R/t_F = 2ns$ | B | +25 | - | 4 | - | % |

Electrical Specifications $V_{SUPPLY} = \pm 5V$, $A_V = +1$, $R_F = 510\Omega$, $R_L = 100\Omega$, Unless Otherwise Specified (Continued)

| PARAMETER | TEST CONDITIONS | TEST LEVEL (Note 2) | TEMP. (°C) | MIN | TYP | MAX | UNITS |
|--------------------------|------------------------------|---------------------|------------|-----|--------------|-----|---------|
| Overdrive Recovery Time | $V_{IN} = \pm 1V$ | B | +25 | - | 0.75 | 1.5 | ns |
| Negative Clamp Range | | B | +25 | - | -5.0 to +2.0 | - | V |
| Positive Clamp Range | | B | +25 | - | -2.0 to +5.0 | - | V |
| Clamp Input Bias Current | | A | +25 | - | 50 | 200 | μA |
| Clamp Input Bandwidth | V_H or $V_L = 100mV_{P-P}$ | B | +25 | - | 500 | - | MHz |

NOTES:

- Test Level: A. Production Tested; B. Typical or Guaranteed Limit Based on Characterization; C. Design Typical for Information Only.
- See Typical Performance Curves for more information.

Application Information

Optimum Feedback Resistor (R_F)

The enclosed plots of inverting and non-inverting frequency response detail the performance of the HFA1130 in various gains. Although the bandwidth dependency on A_{CL} isn't as severe as that of a voltage feedback amplifier, there is an appreciable decrease in bandwidth at higher gains. This decrease can be minimized by taking advantage of the current feedback amplifier's unique relationship between bandwidth and R_F . All current feedback amplifiers require a feedback resistor, even for unity gain applications, and the R_F , in conjunction with the internal compensation capacitor, sets the dominant pole of the frequency response. Thus, the amplifier's bandwidth is inversely proportional to R_F . The HFA1130 design is optimized for a 510Ω R_F , at a gain of +1. Decreasing R_F in a unity gain application decreases stability, resulting in excessive peaking and overshoot (Note: Capacitive feedback causes the same problems due to the feedback impedance decrease at higher frequencies). At higher gains the amplifier is more stable, so R_F can be decreased in a trade-off of stability for bandwidth. The table below lists recommended R_F values for various gains, and the expected bandwidth.

| A_{CL} | R_F (Ω) | BW (MHz) |
|----------|--------------------|----------|
| +1 | 510 | 850 |
| -1 | 430 | 580 |
| +2 | 360 | 670 |
| +5 | 150 | 520 |
| +10 | 180 | 240 |
| +19 | 270 | 125 |

Clamp Operation

General

The HFA1130 features user programmable output clamps to limit output voltage excursions. Clamping action is obtained by applying voltages to the V_H and V_L terminals (pins 8 and 5) of the amplifier. V_H sets the upper output limit, while V_L sets the lower clamp level. If the amplifier tries to drive the

output above V_H , or below V_L , the clamp circuitry limits the output voltage at V_H or V_L (\pm the clamp accuracy), respectively. The low input bias currents of the clamp pins allow them to be driven by simple resistive divider circuits, or active elements such as amplifiers or DACs.

Clamp Circuitry

Figure 1 shows a simplified schematic of the HFA1130 input stage, and the high clamp (V_H) circuitry. As with all current feedback amplifiers, there is a unity gain buffer ($Q_{X1} - Q_{X2}$) between the positive and negative inputs. This buffer forces $-IN$ to track $+IN$, and sets up a slewing current of $(V_{-IN} - V_{OUT})/R_F$. This current is mirrored onto the high impedance node (Z) by $Q_{X3} - Q_{X4}$, where it is converted to a voltage and fed to the output via another unity gain buffer. If no clamping is utilized, the high impedance node may swing within the limits defined by Q_{P4} and Q_{N4} . Note that when the output reaches its quiescent value, the current flowing through $-IN$ is reduced to only that small current ($-I_{BIAS}$) required to keep the output at the final voltage.

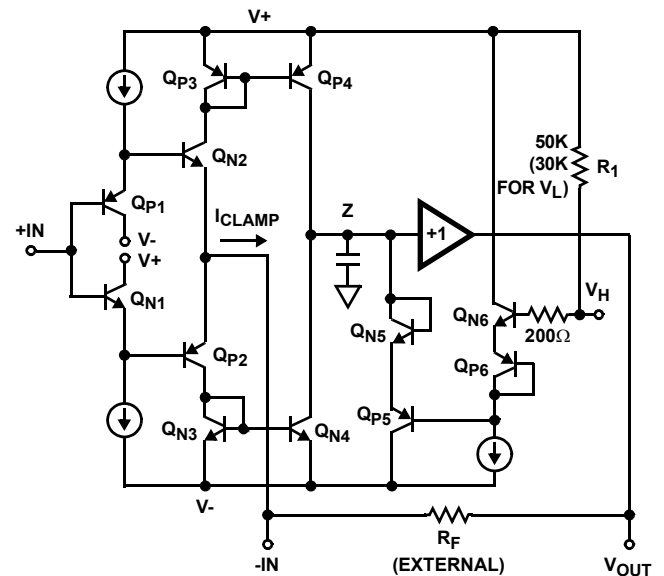

FIGURE 1. HFA1130 SIMPLIFIED V_H CLAMP CIRCUITRY

Tracing the path from V_H to Z illustrates the effect of the clamp voltage on the high impedance node. V_H decreases by $2V_{BE}$ (Q_{N6} and Q_{P6}) to set up the base voltage on Q_{P5} . Q_{P5} begins to conduct whenever the high impedance node reaches a voltage equal to Q_{P5} 's base + $2V_{BE}$ (Q_{P5} and Q_{N5}). Thus, Q_{P5} clamps node Z whenever Z reaches V_H . R_1 provides a pull-up network to ensure functionality with the clamp inputs floating. A similar description applies to the symmetrical low clamp circuitry controlled by V_L .

When the output is clamped, the negative input continues to source a slewing current (I_{CLAMP}) in an attempt to force the output to the quiescent voltage defined by the input. Q_{P5} must sink this current while clamping, because the -IN current is always mirrored onto the high impedance node. The clamping current is calculated as $(V_{-IN} - V_{OUT})/R_F$. As an example, a unity gain circuit with $V_{IN} = 2V$, $V_H = 1V$, and $R_F = 510\Omega$ would have $I_{CLAMP} = (2-1)/510\Omega = 1.96mA$. Note that I_{CC} will increase by I_{CLAMP} when the output is clamp limited.

Clamp Accuracy

The clamped output voltage will not be exactly equal to the voltage applied to V_H or V_L . Offset errors, mostly due to V_{BE} mismatches, necessitate a clamp accuracy parameter which is found in the device specifications. Clamp accuracy is a function of the clamping conditions. Referring again to Figure 1, it can be seen that one component of clamp accuracy is the V_{BE} mismatch between the Q_{X6} transistors, and the Q_{X5} transistors. If the transistors always ran at the same current level there would be no V_{BE} mismatch, and no contribution to the inaccuracy. The Q_{X6} transistors are biased at a constant current, but as described earlier, the current through Q_{X5} is equivalent to I_{CLAMP} . V_{BE} increases as I_{CLAMP} increases, causing the clamped output voltage to increase as well. I_{CLAMP} is a function of the overdrive level ($V_{-IN} - V_{OUTCLAMPED}$) and R_F , so clamp accuracy degrades as the overdrive increases, or as R_F decreases. As an example, the specified accuracy of $\pm 60mV$ for a 2X overdrive with $R_F = 510\Omega$ degrades to $\pm 220mV$ for $R_F = 240\Omega$ at the same overdrive, or to $\pm 250mV$ for a 3X overdrive with $R_F = 510\Omega$.

Consideration must also be given to the fact that the clamp voltages have an effect on amplifier linearity. The "Nonlinearity Near Clamp Voltage" curve in the data sheet illustrates the impact of several clamp levels on linearity.

Clamp Range

Unlike some competitor devices, both V_H and V_L have usable ranges that cross 0V. While V_H must be more positive than V_L , both may be positive or negative, within the range restrictions indicated in the specifications. For example, the HFA1130 could be limited to ECL output levels by setting $V_H = -0.8V$ and $V_L = -1.8V$. V_H and V_L may be connected to the same voltage (GND for instance) but the result won't be in a DC output voltage from an AC input signal. A 150 - 200mV AC signal will still be present at the output.

Recovery from Overdrive

The output voltage remains at the clamp level as long as the overdrive condition remains. When the input voltage drops below the overdrive level (V_{CLAMP}/A_{VCL}) the amplifier will return to linear operation. A time delay, known as the Overdrive Recovery Time, is required for this resumption of linear operation. The plots of "Unclamped Performance" and "Clamped Performance" highlight the HFA1130's subnanosecond recovery time. The difference between the unclamped and clamped propagation delays is the overdrive recovery time. The appropriate propagation delays are 4.0ns for the unclamped pulse, and 4.8ns for the clamped (2X overdrive) pulse yielding an overdrive recovery time of 800ps. The measurement uses the 90% point of the output transition to ensure that linear operation has resumed. Note: The propagation delay illustrated is dominated by the fixturing. The delta shown is accurate, but the true HFA1130 propagation delay is 500ps.

Use of Die in Hybrid Applications

This amplifier is designed with compensation to negate the package parasitics that typically lead to instabilities. As a result, the use of die in hybrid applications results in overcompensated performance due to lower parasitic capacitances. Reducing R_F below the recommended values for packaged units will solve the problem. For $A_V = +2$ the recommended starting point is 300Ω , while unity gain applications should try 400Ω .

PC Board Layout

The frequency performance of this amplifier depends a great deal on the amount of care taken in designing the PC board. **The use of low inductance components such as chip resistors and chip capacitors is strongly recommended, while a solid ground plane is a must!**

Attention should be given to decoupling the power supplies. A large value ($10\mu F$) tantalum in parallel with a small value chip ($0.1\mu F$) capacitor works well in most cases.

Terminated microstrip signal lines are recommended at the input and output of the device. Output capacitance, such as that resulting from an improperly terminated transmission line will degrade the frequency response of the amplifier and may cause oscillations. In most cases, the oscillation can be avoided by placing a resistor in series with the output.

Care must also be taken to minimize the capacitance to ground seen by the amplifier's inverting input. The larger this capacitance, the worse the gain peaking, resulting in pulse overshoot and possible instability. To this end, it is recommended that the ground plane be removed under traces connected to pin 2, and connections to pin 2 should be kept as short as possible.

An example of a good high frequency layout is the Evaluation Board shown below.

Evaluation Board

An evaluation board is available for the HFA1130, (Part Number HFA11XXEVAL). Please contact your local sales office for information.

Note: The SOIC version may be evaluated in the DIP board by using a SOIC-to-DIP adapter such as Aries Electronics Part Number 08-350000-10.

The layout and schematic of the board are shown here:

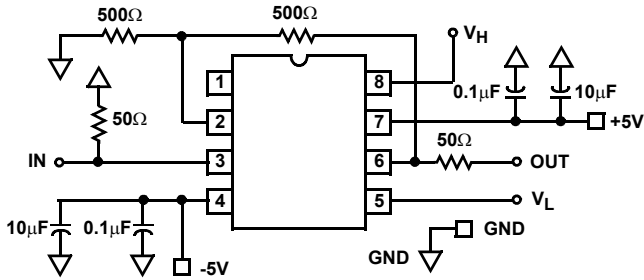
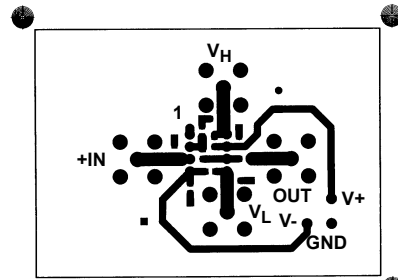
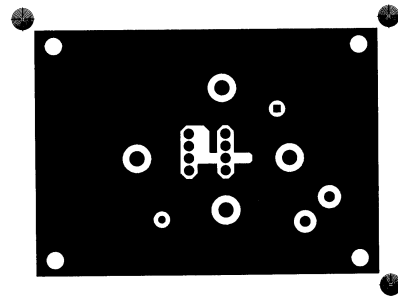

FIGURE 2. BOARD SCHEMATIC

TOP LAYOUT



BOTTOM LAYOUT



Typical Performance Curves $V_{SUPPLY} = \pm 5V$, $R_F = 510\Omega$, $T_A = +25^\circ C$, $R_L = 100\Omega$, Unless Otherwise Specified

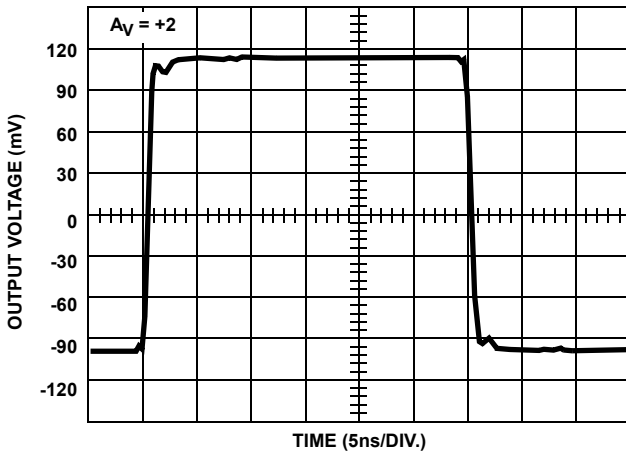

FIGURE 3. SMALL SIGNAL PULSE RESPONSE

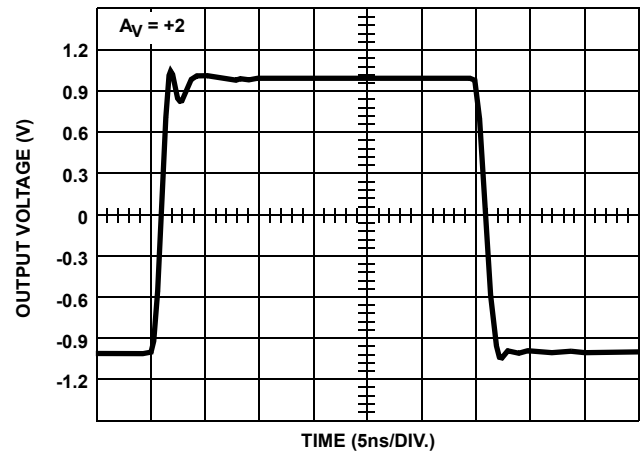

FIGURE 4. LARGE SIGNAL PULSE RESPONSE

Typical Performance Curves $V_{SUPPLY} = \pm 5V$, $R_F = 510\Omega$, $T_A = +25^\circ C$, $R_L = 100\Omega$, Unless Otherwise Specified (Continued)

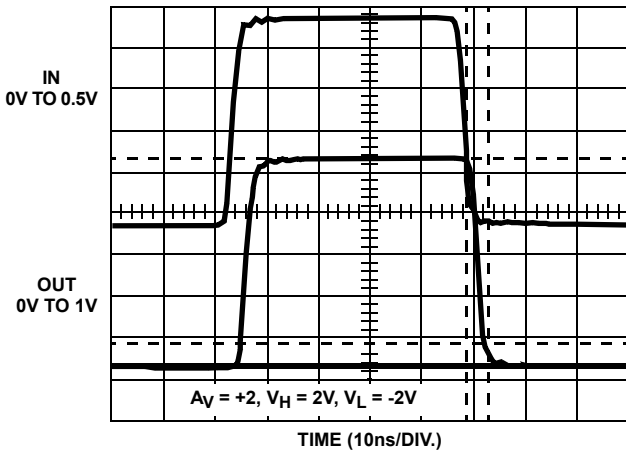

FIGURE 5. UNCLAMPED PERFORMANCE

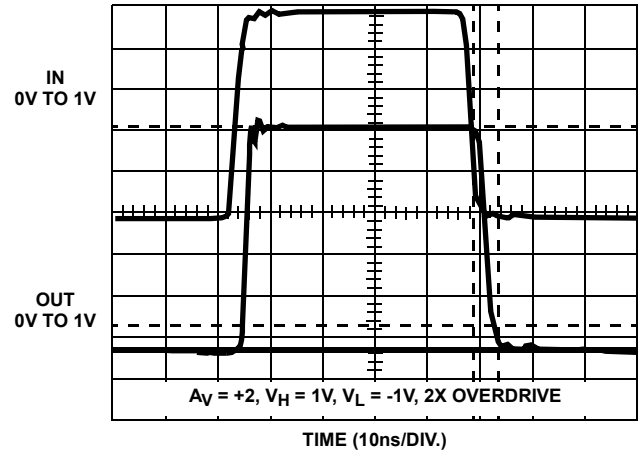

FIGURE 6. CLAMPED PERFORMANCE

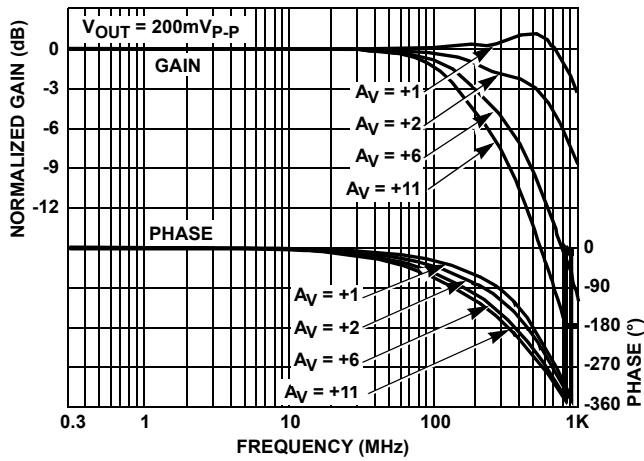

FIGURE 7. NON-INVERTING FREQUENCY RESPONSE

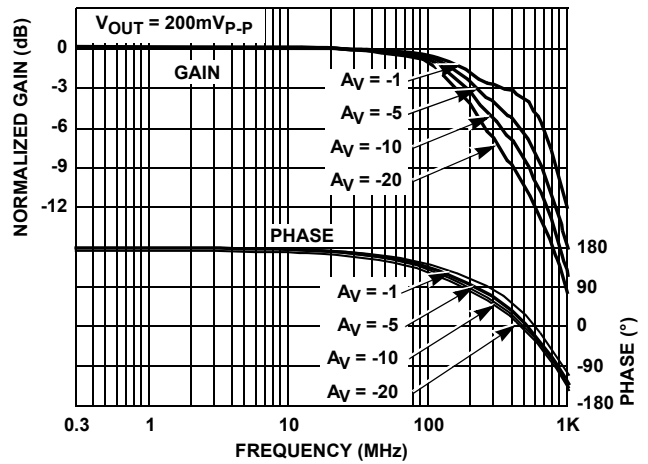

FIGURE 8. INVERTING FREQUENCY RESPONSE

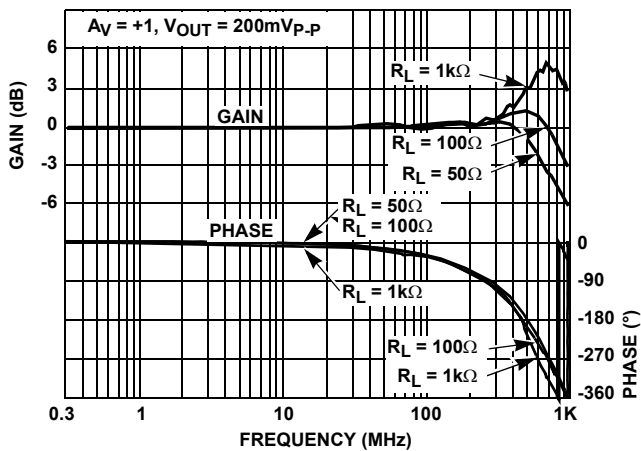

FIGURE 9. FREQUENCY RESPONSE FOR VARIOUS LOAD RESISTORS

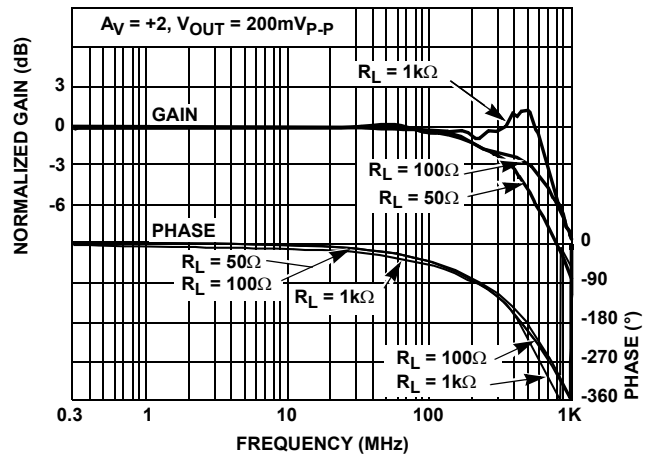

FIGURE 10. FREQUENCY RESPONSE FOR VARIOUS LOAD RESISTORS

Typical Performance Curves $V_{SUPPLY} = \pm 5V$, $R_F = 510\Omega$, $T_A = +25^\circ C$, $R_L = 100\Omega$, Unless Otherwise Specified (Continued)

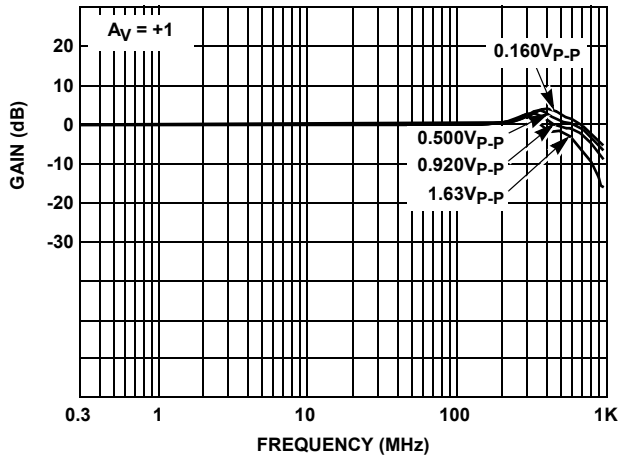

FIGURE 11. FREQUENCY RESPONSE FOR VARIOUS OUTPUT VOLTAGES

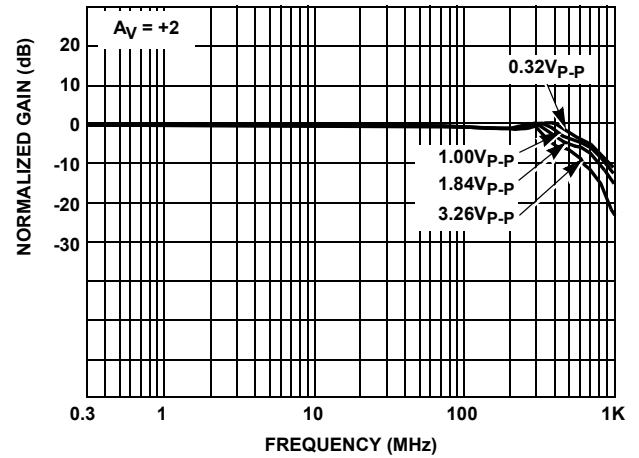

FIGURE 12. FREQUENCY RESPONSE FOR VARIOUS OUTPUT VOLTAGES

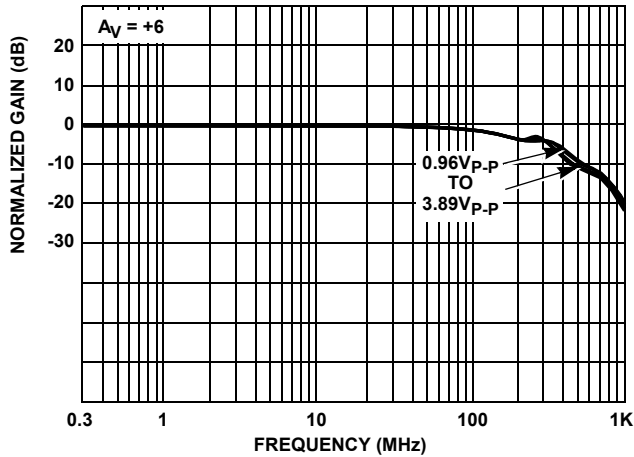

FIGURE 13. FREQUENCY RESPONSE FOR VARIOUS OUTPUT VOLTAGES

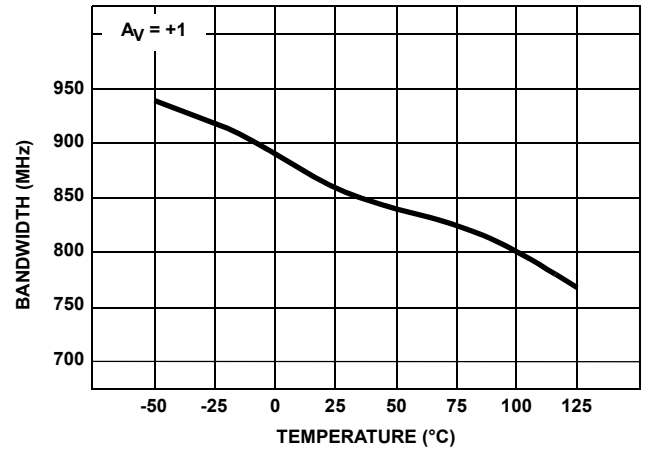

FIGURE 14. -3dB BANDWIDTH vs TEMPERATURE

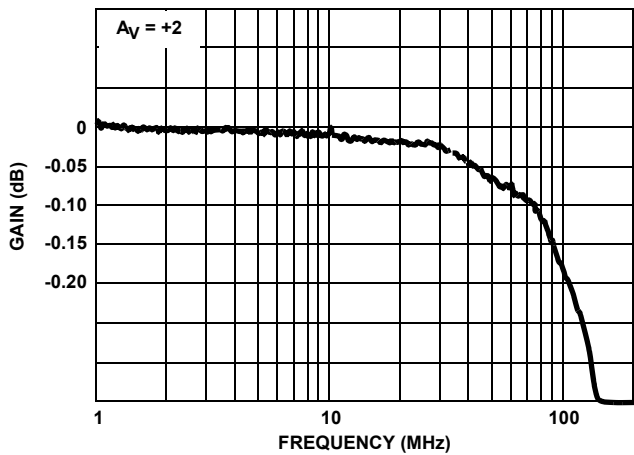

FIGURE 15. GAIN FLATNESS

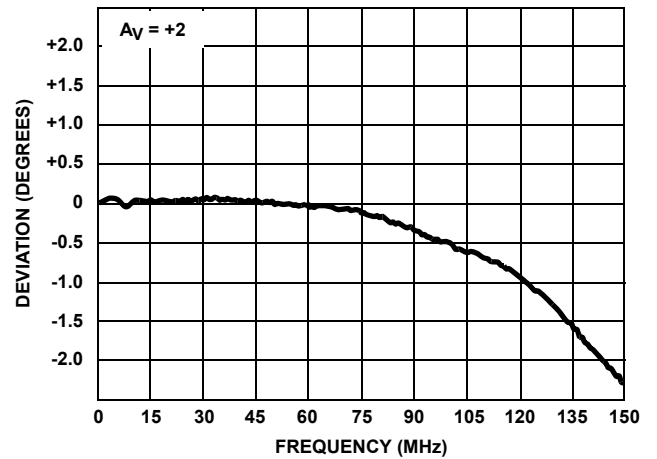

FIGURE 16. DEVIATION FROM LINEAR PHASE

Typical Performance Curves $V_{SUPPLY} = \pm 5V$, $R_F = 510\Omega$, $T_A = +25^\circ C$, $R_L = 100\Omega$, Unless Otherwise Specified (Continued)

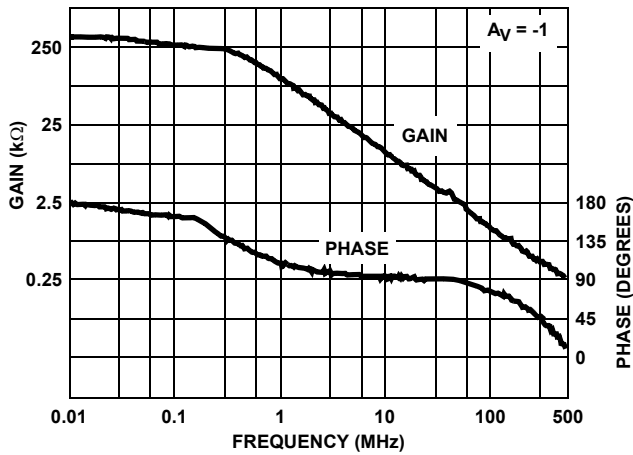

FIGURE 17. OPEN LOOP TRANSIMPEDANCE

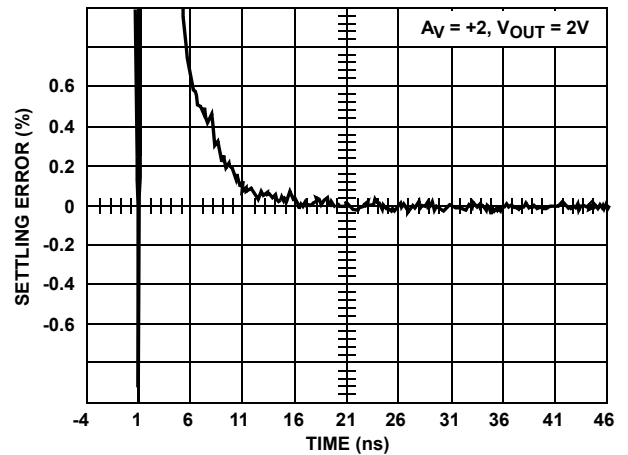

FIGURE 18. SETTLING RESPONSE

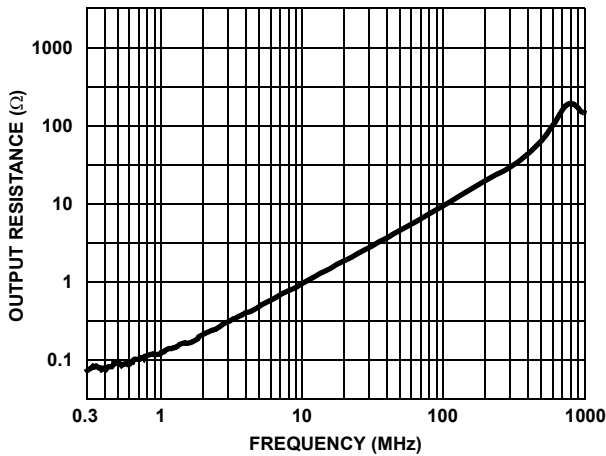

FIGURE 19. CLOSED LOOP OUTPUT RESISTANCE

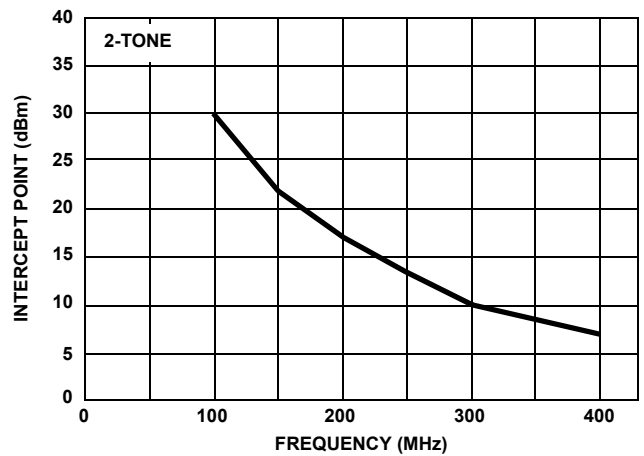

FIGURE 20. 3rd ORDER INTERMODULATION INTERCEPT

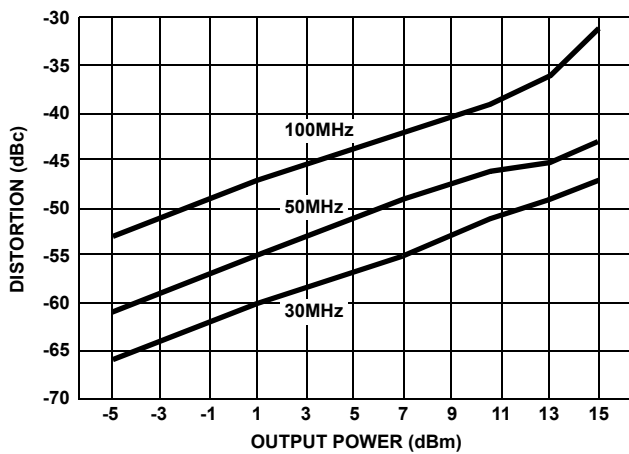

FIGURE 21. 2nd HARMONIC DISTORTION vs P_{OUT}

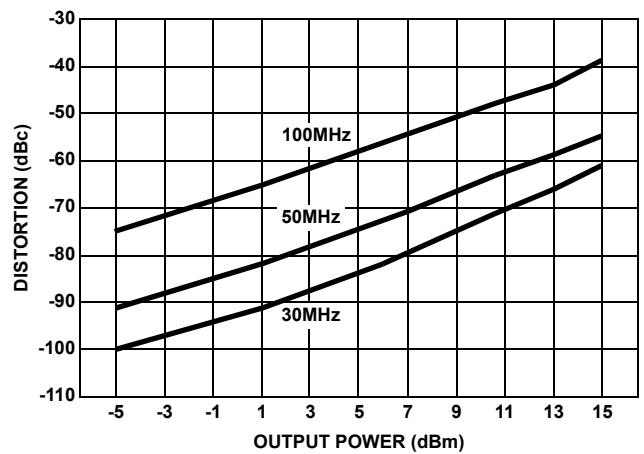

FIGURE 22. 3rd HARMONIC DISTORTION vs P_{OUT}

Typical Performance Curves $V_{SUPPLY} = \pm 5V$, $R_F = 510\Omega$, $T_A = +25^\circ C$, $R_L = 100\Omega$, Unless Otherwise Specified (Continued)

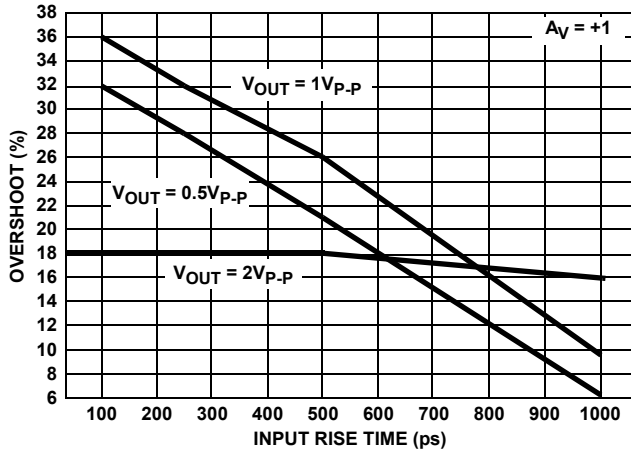

FIGURE 23. OVERSHOOT vs INPUT RISE TIME

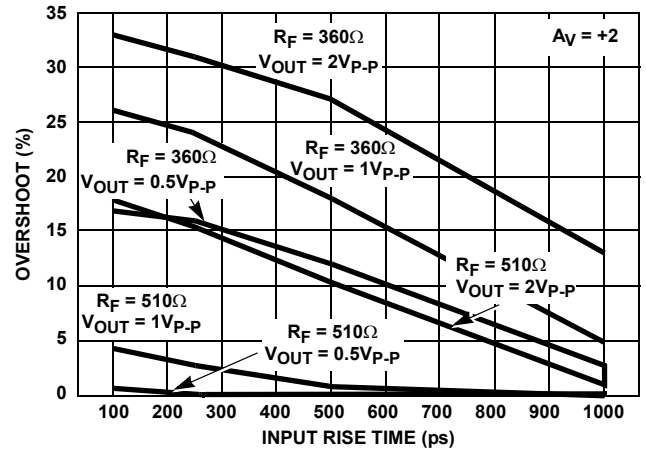

FIGURE 24. OVERSHOOT vs INPUT RISE TIME

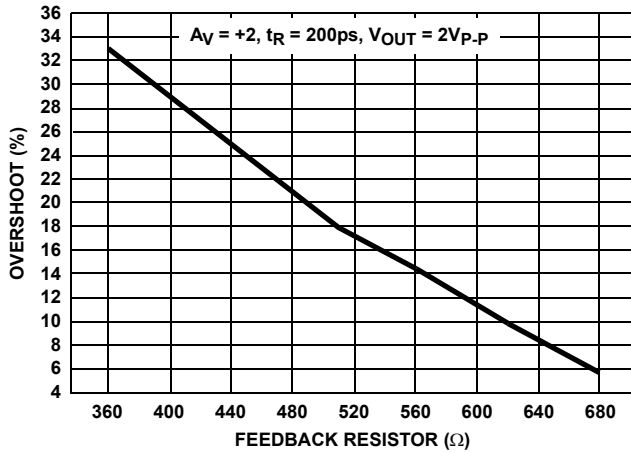

FIGURE 25. OVERSHOOT vs FEEDBACK RESISTOR

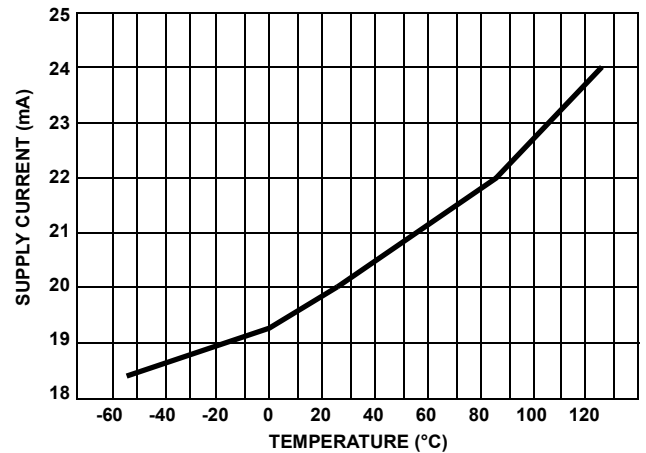

FIGURE 26. SUPPLY CURRENT vs TEMPERATURE

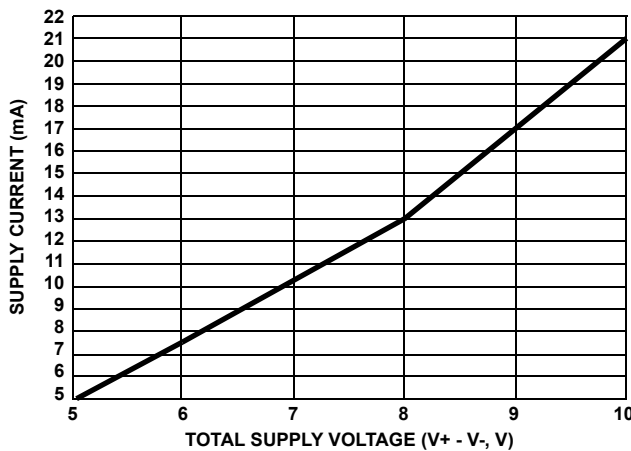

FIGURE 27. SUPPLY CURRENT vs SUPPLY VOLTAGE

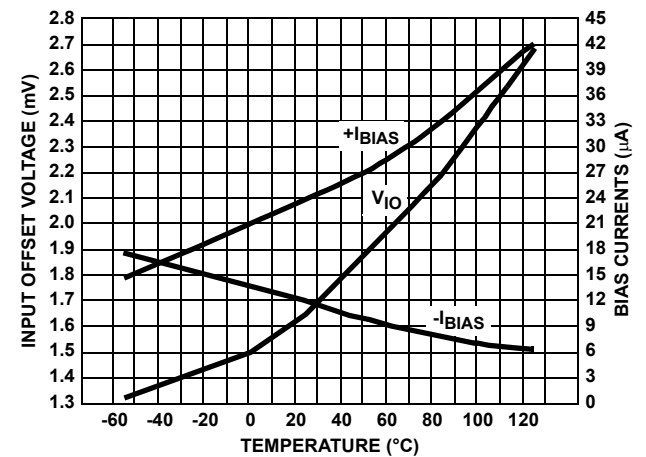

FIGURE 28. V_{IO} AND BIAS CURRENTS vs TEMPERATURE

Typical Performance Curves $V_{SUPPLY} = \pm 5V$, $R_F = 510\Omega$, $T_A = +25^\circ C$, $R_L = 100\Omega$, Unless Otherwise Specified (Continued)

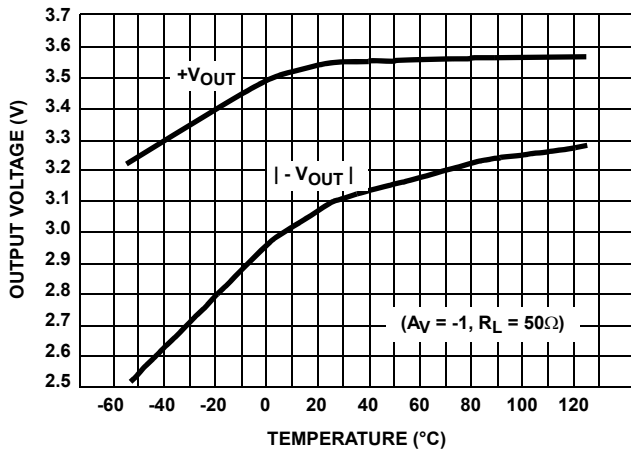

FIGURE 29. OUTPUT VOLTAGE vs TEMPERATURE

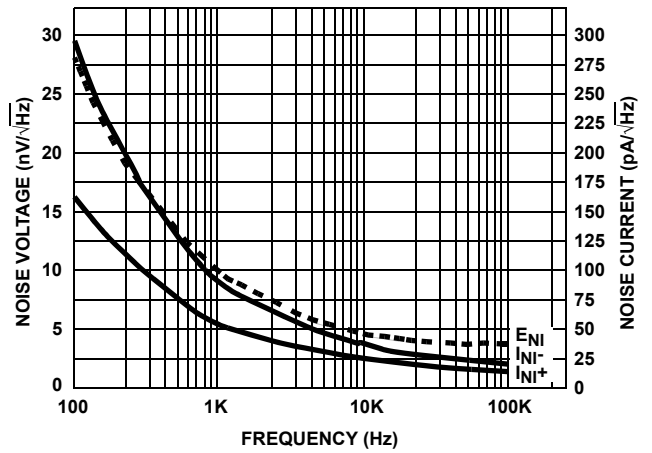

FIGURE 30. INPUT NOISE vs FREQUENCY

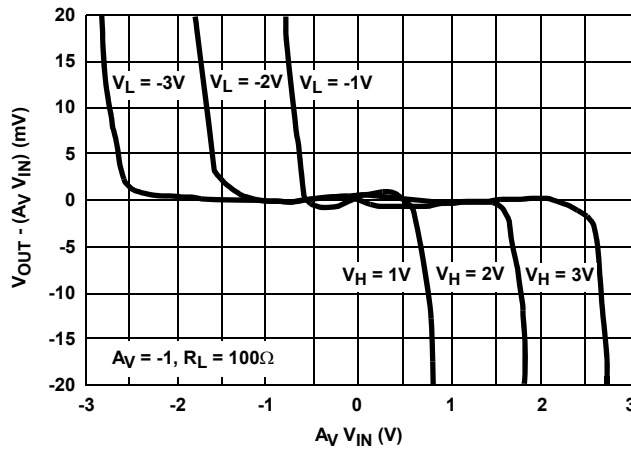

FIGURE 31. NON-LINEARITY NEAR CLAMP VOLTAGE

Die Characteristics

DIE DIMENSIONS:

63 mils x 44 mils x 19 mils
 1600µm x 1130µm

METALLIZATION:

Type: Metal 1: AlCu(2%)/TiW
 Thickness: Metal 1: 8kÅ ±0.4kÅ
 Type: Metal 2: AlCu(2%)
 Thickness: Metal 2: 16kÅ ±0.8kÅ

PASSIVATION:

Type: Nitride
 Thickness: 4kÅ ±0.5kÅ

TRANSISTOR COUNT:

52

SUBSTRATE POTENTIAL (Powered Up):

Floating (Recommend Connection to V-)

Metallization Mask Layout

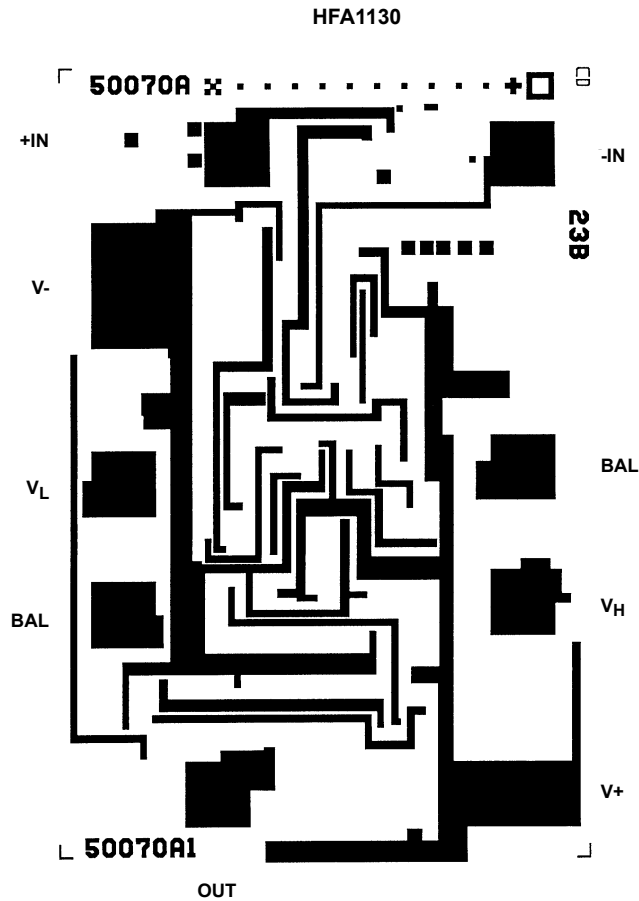

© Copyright Intersil Americas LLC 2002-2013. All Rights Reserved.
 All trademarks and registered trademarks are the property of their respective owners.

For additional products, see www.intersil.com/en/products.html

Intersil products are manufactured, assembled and tested utilizing ISO9001 quality systems as noted in the quality certifications found at www.intersil.com/en/support/qualandreliability.html

Intersil products are sold by description only. Intersil may modify the circuit design and/or specifications of products at any time without notice, provided that such modification does not, in Intersil's sole judgment, affect the form, fit or function of the product. Accordingly, the reader is cautioned to verify that datasheets are current before placing orders. Information furnished by Intersil is believed to be accurate and reliable. However, no responsibility is assumed by Intersil or its subsidiaries for its use; nor for any infringements of patents or other rights of third parties which may result from its use. No license is granted by implication or otherwise under any patent or patent rights of Intersil or its subsidiaries.

For information regarding Intersil Corporation and its products, see www.intersil.com