

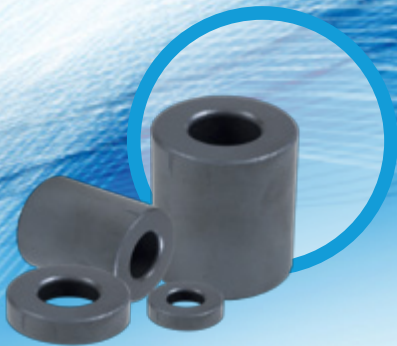

Smart Technology. Delivered.™

# Ferrite EMI Cable Cores





## About Laird

Laird is a global technology business focused on enabling wireless communication and smart systems, and providing components and systems that protect electronics. Laird operates through two divisions, Wireless Systems and Performance Materials. Wireless Systems solutions include antenna systems, embedded wireless modules, telematics products and wireless automation and control solutions. Performance Materials solutions include electromagnetic interference shielding, thermal management and signal integrity products. As a leader in the design, supply and support of innovative technology, our products allow people, organisations, machines and applications to connect effectively, helping to build a world where smart technology transforms the way of life. Custom products are supplied to major sectors of the electronics industry including the handset, telecommunications, IT, automotive, public safety, consumer, medical, rail, mining and industrial markets. Providing value and differentiation to our customers through innovation, reliable fulfilment and speed, Laird PLC is listed and headquartered in London, and employs over 9,000 people in more than 58 facilities located in 18 countries.



## TABLE OF CONTENTS

|   |    |
|---|----|
| Ferrite Material Impedance Comparison .....           | 3  |
| Design & Selection “Rules of Thumb” .....             | 3  |
| High Frequency (HFB-) Cylindrical Cores .....         | 4  |
| High Frequency (HFA-) Split, Snap-On Cores .....      | 5  |
| Broadband (28B-) Cylindrical Cores .....              | 6  |
| Broadband (28A-) Split, Snap-On Cores .....           | 9  |
| Low Frequency (LFB-) Cylindrical Cores .....          | 15 |
| Broadband (28R) Ribbon & Flex Cable Cores .....       | 16 |
| Broadband (28S) Split Ribbon & Flex Cable Cores ..... | 20 |
| Ferrite EMI Disks & Plates .....                      | 26 |
| Ferrite Plates for Wireless Charging .....            | 27 |
| Flexible Ferrite Sheets .....                         | 29 |
| Sample Kit Lists .....                                | 32 |



All parts listed in this catalog are lead free and RoHS compliant.

### NOTICE

Laird’s products or subcomponents are not specifically designed or tested by Laird for use in any medical applications, surgical applications, medical device manufacturing, or any similar procedure or process requiring approval, testing, or certification by the United States food and drug administration or other similar Governmental entity. Applications with unusual environmental requirements such as military, medical, life-support or Life-sustaining equipment are specifically not recommended without additional testing for such application.

## FERRITE MATERIAL COMPARISON

### LF, 28 & HF MATERIAL IMPEDANCE VS FREQUENCY (300 KHz - 2 GHz) Impedance Materials for Cable & Wiring Harness Cores

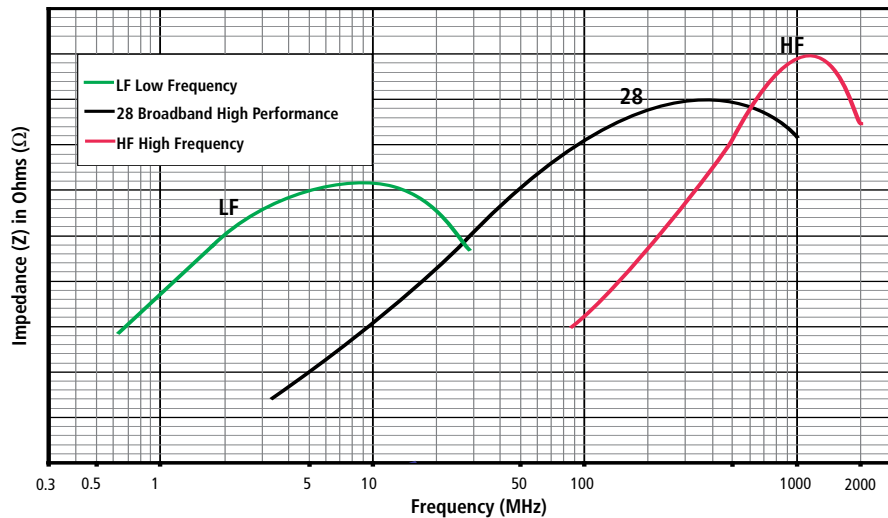

## DESIGN & SELECTION "RULES OF THUMB"

### SELECT THE APPROPRIATE FERRITE MATERIAL

For the EMI frequency range to be attenuated, refer to cable core material impedance vs. frequency chart above.

### FERRITE MATERIAL COMPOSITION AFFECTS CORE PERFORMANCE MOST

High-performance material is best. Cheap, low-performance materials require the use of larger, heavier cores.

### SHAPE (DESIGN) AND MASS OF THE FERRITE CORE SIGNIFICANTLY AFFECT IMPEDANCE

#### DON'T OVER SIZE

Use high-performance ferrite material and select the smallest core that will do the job. High-performance material allows the use of smaller, lighter and lower cost cores.

### SELECT A FERRITE CORE THAT FITS OVER THE CABLE'S OUTSIDE DIMENSIONS

Core should slide easily over the cable during installation.

### WHEN POSSIBLE, INSTALL A CABLE CORE OVER WIRES IN A COMMON MODE CONFIGURATION

(Out and back lines inside the same ferrite cable core). A differential cable pair inside the same core will make the ferrite core a common mode choke that is not susceptible to saturation from very high currents.

### INSTALL THE FERRITE CORE NEAR THE NOISE SOURCE

### ADDITIONAL TURNS THROUGH A CORE WILL PROVIDE MULTIPLE AMOUNTS OF PEAK IMPEDANCE

Example: Two wire turns provide four times the impedance of one turn (pass through) the ferrite core. Also, with each added turn, the peak impedance shifts to a slightly lower frequency.

### TWO-PIECE SPLIT CORES ARE AVAILABLE

One-piece cylindrical or flat ribbon ferrite core shapes are usually preferable, but split cores can be used in applications where cores cannot slide over cable ends and connectors. Some split cores are available with snap-on plastic cases or metal clips.

### SIDE-BY-SIDE IMPEDANCE TESTING OF FERRITE CORES IS THE BEST WAY TO COMPARE PERFORMANCE OF DIFFERENT CORES

Ferrite core impedance measurement equipment and test methods are not standardized in the industry. Every ferrite company has their own test methods. Catalog (web site) impedance data cannot be accurately compared.

Optimized, high-performance, low-cost custom part designs are available.

# HIGH FREQUENCY FERRITE CYLINDRICAL EMI CORES



## 300 MHZ TO 2 GHZ OPTIMIZED

Cylindrical Solid Ferrite Cores for Round Cables & Wiring Harnesses

### PART NUMBERING SYSTEM EXAMPLE

|               |              |                     |  |                             |   |
|---------------|--------------|---------------------|--|-----------------------------|---|
| <b>HF</b>     | <b>B</b>     | <b>075024</b>       | <b>-0</b>                                | <b>0</b>                    | <b>0</b>                                    |
| Material Type | Product Code | Part Size Code (mm) | Selected Dimension Code (Usually Length) | Additional Part Description | Additional Part Description or Coating Code |

| Part Number   | DIMENSIONS mm (inches) |               |               | Typical Impedance (Z) in Ohms (Ω) |           |           |         |
|---------------|------------------------|---------------|---------------|-----------------------------------|-----------|-----------|---------|
|               | A                      | B             | C             | @ 300 MHz                         | @ 500 MHz | @ 800 MHz | @ 1 GHz |
| HFB0473-200   | 12.00 (0.472)          | 3.55 (0.140)  | 25.00 (0.984) | 320                               | 378       | -         | 147     |
| HFB075024-000 | 7.50 (0.295)           | 2.40 (0.094)  | 10.00 (0.394) | 124                               | 136       | 138       | 133     |
| HFB095051-100 | 9.52 (0.375)           | 5.08 (0.200)  | 10.00 (0.394) | 64                                | 74        | 89        | 85      |
| HFB095051-200 | 9.52 (0.375)           | 5.08 (0.200)  | 19.00 (0.748) | 120                               | 135       | 151       | 147     |
| HFB123049-000 | 12.32 (0.485)          | 4.88 (0.192)  | 5.00 (0.197)  | 50                                | 56        | 63        | 61      |
| HFB123049-100 | 12.32 (0.485)          | 4.88 (0.192)  | 10.00 (0.394) | 97                                | 110       | 120       | 115     |
| HFB123049-300 | 12.32 (0.485)          | 4.88 (0.192)  | 25.40 (1.000) | 258                               | 287       | 300       | 246     |
| HFB143064-000 | 14.27 (0.562)          | 6.35 (0.250)  | 5.00 (0.197)  | 43                                | 50        | 58        | 60      |
| HFB143064-100 | 14.27 (0.562)          | 6.35 (0.250)  | 10.00 (0.394) | 85                                | 100       | 113       | 115     |
| HFB143064-300 | 14.27 (0.562)          | 6.35 (0.250)  | 28.58 (1.125) | 270                               | 315       | 270       | 200     |
| HFB150070-200 | 14.99 (0.590)          | 6.99 (0.275)  | 28.58 (1.125) | 242                               | 287       | 270       | 204     |
| HFB152034-000 | 15.24 (0.600)          | 3.38 (0.133)  | 10.00 (0.394) | 165                               | 190       | 189       | 185     |
| HFB157070-000 | 15.65 (0.616)          | 6.99 (0.275)  | 20.00 (0.787) | 170                               | 200       | 220       | 205     |
| HFB159079-000 | 15.88 (0.625)          | 7.87 (0.310)  | 20.00 (0.787) | 150                               | 175       | 186       | 195     |
| HFB159079-100 | 15.88 (0.625)          | 7.87 (0.310)  | 28.58 (1.125) | 235                               | 290       | 302       | 260     |
| HFB160093-200 | 16.00 (0.630)          | 9.25 (0.364)  | 19.00 (0.748) | 120                               | 145       | 155       | 170     |
| HFB160093-300 | 16.00 (0.630)          | 9.25 (0.364)  | 27.99 (1.102) | 170                               | 198       | 232       | 220     |
| HFB170070-000 | 16.99 (0.669)          | 7.01 (0.276)  | 10.00 (0.394) | 97                                | 115       | 127       | 140     |
| HFB170070-100 | 16.99 (0.669)          | 7.01 (0.276)  | 20.00 (0.787) | 185                               | 215       | 239       | 220     |
| HFB187102-100 | 18.67 (0.735)          | 10.16 (0.400) | 30.00 (1.181) | 205                               | 250       | 270       | 210     |
| HFB259128-100 | 25.91 (1.020)          | 12.83 (0.505) | 28.58 (1.125) | 175                               | 210       | 254       | 250     |

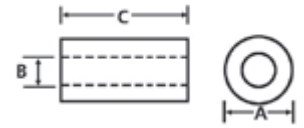

All impedance values for high frequency cores are NET; NET impedance is impedance of the ferrite core only. All impedance contribution from the test wire and fixtures has been removed.

# HIGH FREQUENCY FERRITE SPLIT / SNAP-ON, CORES IN PLASTIC CASES



## 300 MHZ TO 2 GHZ OPTIMIZED

Split, Snap-on Ferrite Cores in Plastic Cases

For retrofit and post-assembly operations, a selection of high frequency EMI “split” cores are offered. Similar in performance to one-piece cylindrical core designs, these split ferrite cores provide excellent common and differential mode high frequency EMI suppression on round cable and wire assemblies. Black plastic snap-on cases provide secure closure of the split cores onto the cable or wire bundle.

### PART NUMBERING SYSTEM EXAMPLE

|               |              |                     |  |                             |                         |
|---------------|--------------|---------------------|--|-----------------------------|-------------------------|
| <b>HF</b>     | <b>A</b>     | <b>100035</b>       | <b>-0</b>                                | <b>A</b>                    | <b>2</b>                |
| Material Type | Product Code | Part Size Code (mm) | Selected Dimension Code (Usually Length) | Additional Part Description | Plastic Case Color Code |

All impedance values for high frequency cores are NET; NET impedance is impedance of the ferrite core only. All impedance contribution from the test wire and fixtures has been removed.

| Part Number   | Fig # | PLASTIC CASE DIMENSIONS mm (inches) |               |               |               | Maximum Cable Diameter mm (inches) | Typical Impedance (Z) in Ohms (Ω) |           |           |         | Laird Solid Cylindrical Core Similar Parts (for reference) |
|---------------|-------|-------------------------------------|---------------|---------------|---------------|------------------------------------|-----------------------------------|-----------|-----------|---------|--|
|               |       | A                                   | B             | C             | D             |                                    | @ 300 MHz                         | @ 500 MHz | @ 800 MHz | @ 1 GHz |  |
| HFA100035-0A2 | 1     | 13.00 (0.511)                       | 3.50 (0.138)  | 25.20 (0.992) | 11.50 (0.453) | 3.51 (0.138)                       | 172                               | 192       | 190       | 150     | HFB123049-300  |
| HFA100049-0A2 | 1     | 13.72 (0.540)                       | 5.44 (0.214)  | 30.56 (1.203) | 13.72 (0.540) | 4.88 (0.192)                       | 133                               | 152       | 168       | 162     | HFB095051-200  |
| HFA150066-0A2 | 2     | 18.15 (0.715)                       | 7.05 (0.278)  | 32.50 (1.280) | 18.90 (0.744) | 6.60 (0.260)                       | 274                               | 350       | 340       | 256     | HFB143064-300  |
| HFA150068-0A2 | 1     | 21.00 (0.827)                       | 6.80 (0.268)  | 41.70 (1.642) | 21.00 (0.827) | 6.76 (0.266)                       | 275                               | 340       | 281       | 200     | HFB150070-200  |
| HFA163090-0A2 | 1     | 20.07 (0.790)                       | 9.07 (0.357)  | 41.55 (1.636) | 21.57 (0.849) | 9.01 (0.355)                       | 210                               | 260       | 262       | 200     | HFB160093-300  |
| HFA187102-0A2 | 2     | 22.88 (0.877)                       | 10.00 (0.394) | 32.77 (1.290) | 21.84 (0.860) | 10.16 (0.400)                      | 220                               | 290       | 281       | 210     | HFB187102-100  |
| HFA259131-0A2 | 2     | 29.00 (1.142)                       | 13.00 (0.512) | 32.50 (1.280) | 29.62 (1.166) | 13.06 (0.514)                      | 250                               | 315       | 272       | 200     | HFB259128-100  |

0A2 part number suffix designates black plastic case. Additional colors may be available, please inquire with Laird customer service.

Figure 1

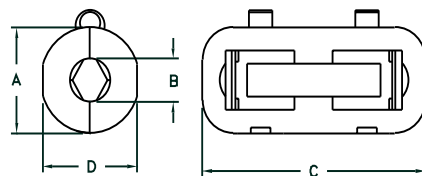
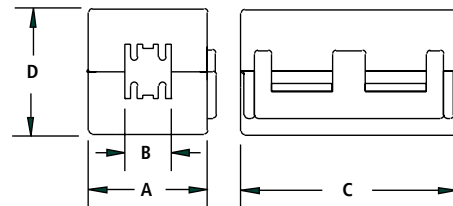

Figure 2



Please visit [lairdtech.com](http://lairdtech.com) for the most up to date information. Custom parts are available.

# BROADBAND EMI FERRITE CYLINDRICAL CORES



## FOR ROUND CABLES & WIRING HARNESSSES

### PART NUMBERING SYSTEM EXAMPLE

|               |              |                |  |                             |   |
|---------------|--------------|----------------|--|-----------------------------|---|
| <b>28</b>     | <b>B</b>     | <b>0141</b>    | <b>-0</b>                                | <b>0</b>                    | <b>0</b>                                    |
| Material Type | Product Code | Part Size Code | Selected Dimension Code (Usually Length) | Additional Part Description | Additional Part Description or Coating Code |

| Part Number | DIMENSIONS mm (inches) |              |               | Typical Impedance (Z) in Ohms (Ω) |           |           |
|-------------|------------------------|--------------|---------------|-----------------------------------|-----------|-----------|
|             | A                      | B            | C             | @ 25 MHz                          | @ 100 MHz | @ 300 MHz |
| 28B0141-000 | 3.50 (0.138)           | 1.50 (0.059) | 3.25 (0.128)  | 30                                | 79        | 192       |
| 28B0157-100 | 4.00 (0.157)           | 2.00 (0.079) | 10.00 (0.394) | 67                                | 121       | 236       |
| 28B0250-100 | 6.35 (0.250)           | 3.18 (0.125) | 15.88 (0.625) | 90                                | 182       | 300       |
| 28B0250-700 | 6.35 (0.250)           | 3.18 (0.125) | 10.00 (0.394) | 64                                | 135       | 255       |
| 28B0268-000 | 6.78 (0.267)           | 3.99 (0.157) | 14.22 (0.560) | 65                                | 138       | 260       |
| 28B0275-000 | 7.00 (0.276)           | 3.80 (0.150) | 13.50 (0.531) | 69                                | 146       | 268       |
| 28B0296-000 | 7.52 (0.296)           | 2.39 (0.94)  | 7.54 (0.297)  | 75                                | 160       | 270       |
| 28B0315-000 | 8.00 (0.315)           | 3.17 (0.125) | 4.78 (0.188)  | 43                                | 100       | 220       |
| 28B0315-100 | 8.00 (0.315)           | 3.17 (0.125) | 10.06 (0.396) | 76                                | 158       | 281       |
| 28B0339-000 | 8.60 (0.339)           | 3.80 (0.150) | 10.00 (0.394) | 68                                | 143       | 264       |
| 28B0355-000 | 9.00 (0.354)           | 4.75 (0.187) | 20.00 (0.787) | 110                               | 205       | 360       |
| 28B0375-000 | 9.53 (0.375)           | 5.08 (0.200) | 10.41 (0.410) | 57                                | 125       | 245       |
| 28B0375-100 | 9.53 (0.375)           | 5.08 (0.200) | 14.48 (0.570) | 74                                | 154       | 282       |
| 28B0375-300 | 9.53 (0.375)           | 5.08 (0.200) | 19.05 (0.750) | 100                               | 194       | 310       |
| 28B0375-400 | 9.52 (0.375)           | 5.08 (0.200) | 4.83 (0.190)  | 33                                | 81        | 200       |
| 28B0384-000 | 9.75 (0.384)           | 3.80 (0.150) | 10.00 (0.394) | 82                                | 159       | 286       |
| 28B0384-200 | 9.75 (0.384)           | 3.80 (0.150) | 25.00 (0.984) | 182                               | 322       | 473       |
| 28B0390-200 | 9.91 (0.390)           | 6.35 (0.250) | 15.00 (0.590) | 57                                | 128       | 248       |
| 28B0394-000 | 10.00 (0.394)          | 5.00 (0.197) | 5.00 (0.197)  | 34                                | 86        | 201       |
| 28B0395-000 | 10.01 (0.394)          | 5.97 (0.235) | 6.17 (0.243)  | 31                                | 83        | 199       |
| 28B0434-000 | 11.00 (0.433)          | 5.10 (0.201) | 32.00 (1.260) | 200                               | 349       | 481       |
| 28B0452-000 | 11.70 (0.461)          | 7.70 (0.303) | 15.00 (0.590) | 52                                | 116       | 235       |
| 28B0453-000 | 11.50 (0.453)          | 4.90 (0.193) | 25.00 (0.984) | 148                               | 262       | 378       |



Broadband (28) round cable parts are sorted by diameter (B) on pages 11 & 12 and sorted by impedance on pages 13 & 14.

Please refer to the separate Toroid Catalog from Laird for an extensive list of small ferrite inductor toroid core sizes and materials.



FERRITE EMI CABLE CORES

BROADBAND EMI FERRITE  
CYLINDRICAL CORES



| Part Number | DIMENSIONS mm<br>(inches) |                  |                  | Typical Impedance (Z)<br>in Ohms ( $\Omega$ ) |              |              |
|-------------|---------------------------|------------------|------------------|---|--------------|--------------|
|             | A                         | B                | C                | @ 25<br>MHz                                   | @ 100<br>MHz | @ 300<br>MHz |
| 28B0470-000 | 12.00<br>(0.472)          | 5.60<br>(0.220)  | 20.00<br>(0.787) | 109   | 211          | 344          |
| 28B0473-000 | 12.00<br>(0.472)          | 3.55<br>(0.140)  | 10.00<br>(0.394) | 101   | 195          | 320          |
| 28B0473-200 | 12.00<br>(0.472)          | 3.55<br>(0.140)  | 25.00<br>(0.984) | 240   | 424          | 558          |
| 28B0474-000 | 12.00<br>(0.472)          | 4.50<br>(0.177)  | 20.00<br>(0.787) | 138   | 245          | 370          |
| 28B0485-000 | 12.32<br>(0.485)          | 4.88<br>(0.192)  | 25.40<br>(1.000) | 170   | 320          | 450          |
| 28B0500-100 | 12.70<br>(0.500)          | 7.92<br>(0.312)  | 6.35<br>(0.250)  | 33  | 83           | 200          |
| 28B0500-300 | 12.70<br>(0.500)          | 7.92<br>(0.312)  | 12.70<br>(0.500) | 54  | 118          | 230          |
| 28B0562-000 | 14.27<br>(0.562)          | 6.35<br>(0.250)  | 10.16<br>(0.400) | 69  | 145          | 270          |
| 28B0562-100 | 14.27<br>(0.562)          | 6.35<br>(0.250)  | 13.46<br>(0.530) | 89  | 184          | 303          |
| 28B0562-200 | 14.27<br>(0.562)          | 6.35<br>(0.250)  | 28.58<br>(1.125) | 159   | 294          | 439          |
| 28B0562-500 | 14.27<br>(0.562)          | 6.35<br>(0.250)  | 38<br>(1.496)    | 196   | 358          | 487          |
| 28B0562-300 | 14.27<br>(0.562)          | 6.35<br>(0.250)  | 28.32<br>(1.115) | 150   | 270          | 420          |
| 28B0563-000 | 14.27<br>(0.562)          | 7.26<br>(0.286)  | 15.24<br>(0.600) | 85  | 173          | 295          |
| 28B0563-100 | 14.27<br>(0.562)          | 7.26<br>(0.286)  | 20.30<br>(0.800) | 109   | 217          | 333          |
| 28B0563-200 | 14.27<br>(0.562)          | 7.26<br>(0.286)  | 28.57<br>(1.125) | 149   | 287          | 406          |
| 28B0570-000 | 14.48<br>(0.570)          | 8.51<br>(0.335)  | 5.51<br>(0.217)  | 32  | 82           | 200          |
| 28B0590-000 | 14.99<br>(0.590)          | 6.99<br>(0.275)  | 27.94<br>(1.100) | 170   | 300          | 450          |
| 28B0591-200 | 15.00<br>(0.591)          | 5.90<br>(0.232)  | 35.00<br>(1.378) | 207   | 377          | 508          |
| 28B0592-000 | 15.00<br>(0.591)          | 4.50<br>(0.177)  | 40.00<br>(1.575) | 361   | 653          | 627          |
| 28B0616-000 | 15.65<br>(0.616)          | 6.99<br>(0.275)  | 28.58<br>(1.125) | 170   | 310          | 450          |
| 28B0625-000 | 15.88<br>(0.625)          | 7.87<br>(0.310)  | 14.27<br>(0.563) | 79  | 163          | 273          |
| 28B0625-100 | 15.88<br>(0.625)          | 7.87<br>(0.310)  | 28.58<br>(1.125) | 150   | 280          | 400          |
| 28B0629-000 | 16.00<br>(0.630)          | 10.00<br>(0.394) | 16.00<br>(0.630) | 60  | 129          | 248          |
| 28B0631-000 | 16.00<br>(0.630)          | 9.25<br>(0.364)  | 11.99<br>(0.472) | 60  | 130          | 250          |
| 28B0631-100 | 16.00<br>(0.630)          | 9.25<br>(0.364)  | 27.99<br>(1.102) | 124   | 243          | 370          |



Additional wire turns  
multiply impedance

# BROADBAND EMI FERRITE CYLINDRICAL CORES

| Part Number  | DIMENSIONS mm (inches) |               |               | Typical Impedance (Z) in Ohms ( $\Omega$ ) |           |           |
|--------------|------------------------|---------------|---------------|--|-----------|-----------|
|              | A                      | B             | C             | @ 25 MHz                                   | @ 100 MHz | @ 300 MHz |
| 28B0672-000  | 17.07 (0.672)          | 8.76 (0.345)  | 25.40 (1.000) | 130  | 245       | 360       |
| 28B0686-000  | 17.42 (0.686)          | 9.52 (0.375)  | 6.35 (0.250)  | 39   | 91        | 214       |
| 28B0686-100  | 17.42 (0.686)          | 9.52 (0.375)  | 12.70 (0.500) | 66   | 139       | 265       |
| 28B0686-200  | 17.42 (0.686)          | 9.53 (0.375)  | 28.58 (1.125) | 124  | 242       | 390       |
| 28B0734-000  | 18.67 (0.735)          | 11.18 (0.440) | 28.58 (1.125) | 116  | 229       | 370       |
| 28B0735-000  | 18.67 (0.735)          | 10.16 (0.400) | 28.58 (1.125) | 135  | 250       | 400       |
| 28B0735-300  | 18.67 (0.735)          | 10.16 (0.400) | 14.27 (0.562) | 73   | 150       | 270       |
| 28B0825-000  | 20.95 (0.825)          | 13.21 (0.520) | 6.35 (0.250)  | 31   | 79        | 204       |
| 28B0870-000  | 22.10 (0.870)          | 13.72 (0.540) | 6.35 (0.250)  | 34   | 85        | 205       |
| 28B0870-100  | 22.10 (0.870)          | 13.72 (0.540) | 12.70 (0.500) | 56   | 122       | 236       |
| 28B0886-20H  | 22.80 (0.898)          | 13.80 (0.543) | 8.80 (0.347)  | 37   | 90        | 199       |
| 28B0999-000  | 25.40 (1.000)          | 15.49 (0.610) | 12.70 (0.500) | 56   | 122       | 247       |
| 28B1000-000  | 25.40 (1.000)          | 12.70 (0.500) | 12.70 (0.500) | 73   | 151       | 278       |
| 28B1020-100  | 25.91 (1.020)          | 12.83 (0.505) | 28.58 (1.125) | 147  | 276       | 412       |
| 28B1122-100  | 28.50 (1.122)          | 13.77 (0.542) | 28.58 (1.125) | 160  | 307       | 440       |
| 28B1122-300  | 28.50 (1.122)          | 13.77 (0.542) | 20.00 (0.787) | 115  | 210       | 350       |
| 28B1142-000  | 29.01 (1.142)          | 19.00 (0.748) | 7.49 (0.295)  | 34   | 85        | 200       |
| 28B1142-100  | 29.01 (1.142)          | 19.00 (0.748) | 13.84 (0.545) | 54   | 114       | 235       |
| 28B1225-000  | 31.12 (1.225)          | 19.05 (0.750) | 15.93 (0.627) | 68   | 140       | 270       |
| 28B1225-100  | 31.12 (1.225)          | 19.05 (0.750) | 7.92 (0.312)  | 39   | 93        | 210       |
| 28B1225-300  | 31.12 (1.225)          | 19.05 (0.750) | 10.00 (0.394) | 46   | 110       | 240       |
| 28B1250-000  | 31.75 (1.250)          | 19.05 (0.750) | 22.22 (0.875) | 92   | 186       | 292       |
| 28B1417-200  | 36.00 (1.417)          | 23.00 (0.905) | 12.70 (0.500) | 52   | 115       | 230       |
| 28B1531-000* | 38.86 (1.530)          | 12.95 (0.510) | 28.58 (1.125) | 109  | 210       | 347       |
| 28B1540-000  | 39.12 (1.540)          | 16.76 (0.660) | 22.22 (0.875) | 130  | 254       | 405       |
| 28B2000-100  | 50.80 (2.000)          | 25.40 (1.000) | 28.70 (1.130) | 157  | 305       | 442       |
| 28B2400-000  | 60.96 (2.400)          | 35.56 (1.400) | 12.70 (0.500) | 60   | 135       | 285       |



| *Oval Core Part Number | DIMENSIONS mm (inches) |               |
|------------------------|------------------------|---------------|
|                        | D                      | E             |
| 28B1531-000            | 26.16 (1.030)          | 26.04 (1.025) |

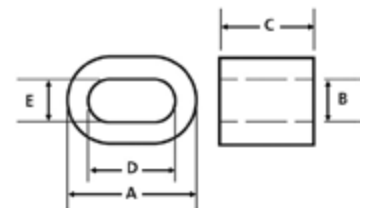

Broadband (28) round cable parts are sorted by diameter (B) on pages 11 & 12 and sorted by impedance on pages 13 & 14.

Custom parts are also available

# BROADBAND EMI FERRITE SPLIT / SNAP-ON CORES IN PLASTIC CASES



## FOR ROUND CABLES & WIRING HARNESES

For retrofit and post-assembly operations, Laird offers a selection of “split” cores. Similar in performance to the one-piece core designs, these split ferrite cores provide excellent common and differential mode EMI suppression on round cable and wire assemblies. Black or white plastic snap-on cases provide secure closure of the split cores onto the cable.

### PART NUMBERING SYSTEM EXAMPLE

|               |              |                |  |                             |  |  |
|---------------|--------------|----------------|--|-----------------------------|--|--|
| <b>28</b>     | <b>A</b>     | <b>0350</b>    | <b>-0</b>                                | <b>B</b>                    | <b>*0 (white case)<br/>*2 (black case)</b> | Broad Band High Performance Material is 28 |
| Material Type | Product Code | Part Size Code | Selected Dimension Code (Usually Length) | Additional Part Description | Plastic Case Color Code                    | High Frequency Material is HF              |

| Part Number | Fig # on page 10 | PLASTIC CASE DIMENSIONS mm (inches) |               |               |               | Maximum Cable Diameter mm (inches) | Typical Impedance (Z) in Ohms (Ω) |           |           | Laird Solid Cylindrical Core Similar Parts (for reference) |
|-------------|------------------|-------------------------------------|---------------|---------------|---------------|------------------------------------|-----------------------------------|-----------|-----------|--|
|             |                  | A                                   | B             | C             | D             |                                    | @ 25 MHz                          | @ 100 MHz | @ 300 MHz |  |
| 28A0350-0B2 | 1                | 13.00 (0.511)                       | 4.90 (0.193)  | 25.50 (1.004) | 11.70 (0.460) | 3.50 (0.138)                       | 100                               | 240       | 400       | 28B0472-090  |
| 28A0392-0A* | 1                | 13.72 (0.540)                       | 5.44 (0.214)  | 30.56 (1.203) | 13.72 (0.540) | 4.75 (0.187)                       | 75                                | 170       | 320       | 28B0375-300  |
| 28A0434-0A2 | 4                | 14.71 (0.579)                       | 5.44 (0.214)  | 43.03 (1.694) | 14.70 (0.579) | 5.05 (0.199)                       | 111                               | 277       | 449       | 28B0434-000  |
| 28A0592-0A2 | 4                | 18.75 (0.738)                       | 5.04 (0.198)  | 53.39 (2.102) | 18.75 (0.738) | 4.40 (0.137)                       | 232                               | 511       | 627       | 28B0592-000  |
| 28A0593-0A2 | 4                | 18.75 (0.738)                       | 6.75 (0.266)  | 52.91 (2.083) | 18.75 (0.738) | 6.50 (0.256)                       | 186                               | 407       | 575       | 28B0591-200  |
| 28A0640-0A* | 1                | 20.07 (0.790)                       | 9.07 (0.357)  | 41.55 (1.636) | 21.57 (0.849) | 8.95 (0.352)                       | 105                               | 240       | 390       | 28B0631-100  |
| 28A0807-0A2 | 4                | 24.82 (0.977)                       | 10.00 (0.394) | 55.91 (2.201) | 24.82 (0.977) | 10.00 (0.394)                      | 160                               | 348       | 514       | 28B0735-000  |
| 28A1507-0A2 | 3                | 15.00 (0.591)                       | 7.00 (0.276)  | 18.00 (0.709) | 22.00 (0.866) | 7.00 (0.276)                       | 56                                | 123       | 246       | 28B0563-100  |
| 28A2005-0A2 | 3                | 13.00 (0.512)                       | 5.00 (0.197)  | 25.50 (1.004) | 11.70 (0.461) | 2.50 (0.098)                       | 88                                | 190       | 330       | 28B0394-000  |
| 28A2024-0A* | 2                | 29.00 (1.142)                       | 13.00 (0.512) | 32.50 (1.280) | 29.62 (1.166) | 12.85 (0.506)                      | 130                               | 280       | 440       | 28B1020-100  |
| 28A2025-0A* | 2                | 18.15 (0.715)                       | 7.05 (0.278)  | 32.50 (1.280) | 18.90 (0.744) | 6.45 (0.254)                       | 130                               | 320       | 510       | 28B0562-200  |
| 28A2026-0A2 | 1                | 21.00 (0.827)                       | 6.80 (0.268)  | 41.70 (1.642) | 21.00 (0.827) | 6.45 (0.254)                       | 95                                | 270       | 460       | 28B0562-200  |
| 28A2029-0A* | 2                | 22.28 (0.877)                       | 10.00 (0.394) | 32.77 (1.290) | 21.84 (0.860) | 9.95 (0.392)                       | 95                                | 250       | 420       | 28B0734-000  |
| 28A2307-0A2 | 3                | 16.50 (0.650)                       | 7.00 (0.276)  | 30.50 (1.201) | 15.25 (0.600) | 7.00 (0.276)                       | 92                                | 183       | 315       | 28B0625-100  |
| 28A2432-0A2 | 3                | 19.20 (0.756)                       | 8.20 (0.323)  | 19.90 (0.783) | 23.10 (0.909) | 8.05 (0.317)                       | 62                                | 160       | 300       | 28B0672-000  |
| 28A2736-0A2 | 1                | 19.70 (0.776)                       | 9.00 (0.354)  | 35.10 (1.382) | 18.00 (0.709) | 8.90 (0.350)                       | 120                               | 220       | 360       | 28B0631-100  |
| 28A2809-0A2 | 3                | 19.70 (0.776)                       | 9.00 (0.354)  | 35.25 (1.388) | 18.25 (0.719) | 9.00 (0.354)                       | 120                               | 220       | 360       | 28B0631-000  |
| 28A2738-0A2 | 3                | 19.70 (0.776)                       | 9.00 (0.354)  | 35.10 (1.382) | 18.00 (0.709) | 8.00 (0.315)                       | 106                               | 233       | 366       | 28B0625-100  |
| 28A2913-0A2 | 3                | 23.50 (0.925)                       | 13.06 (0.514) | 36.25 (1.427) | 22.00 (0.866) | 13.00 (0.512)                      | 86                                | 177       | 305       | 28B1020-100  |
| 28A3039-0A2 | 3                | 24.55 (0.967)                       | 10.20 (0.402) | 13.60 (0.535) | 28.50 (1.122) | 10.15 (0.400)                      | 55                                | 130       | 250       | 28B0735-300  |
| 28A3851-0A2 | 1                | 30.00 (1.181)                       | 13.00 (0.512) | 33.70 (1.327) | 30.00 (1.181) | 12.85 (0.506)                      | 150                               | 260       | 410       | 28B1020-100  |
| 28A4155-0A2 | 3                | 28.80 (1.134)                       | 13.60 (0.535) | 15.40 (0.606) | 33.20 (1.307) | 13.55 (0.533)                      | 50                                | 120       | 230       | 28B0825-000  |
| 28A5131-0A2 | 5                | 56.64 (2.230)                       | 19.50 (0.768) | 45.00 (1.772) | 56.63 (2.230) | 25.40 (1.000)                      | 187                               | 425       | 533       | 28B2000-100  |
| 28A5776-0A2 | 2                | 29.20 (1.150)                       | 20.00 (0.787) | 42.00 (1.654) | 29.40 (1.157) | 19.40 (0.764)                      | 115                               | 210       | 360       | 28B1250-000  |

Broadband (28) round cable parts are sorted by diameter (B) on pages 11 & 12 and sorted by impedance on pages 13 & 14.

\*0A0 = White Plastic Snap On Case  
\*0A2 = Black Plastic Snap On Case

# HIGH FREQUENCY SPLIT / SNAP-ON, FERRITE CORES IN PLASTIC CASES

| Part Number   | Fig # | PLASTIC CASE DIMENSIONS mm (inches) |                  |                  |                  | Maximum Cable Diameter mm (inches) | Typical Impedance (Z) in Ohms (Ω) |           |           |         | Laird Technologies Solid Cylindrical Core Similar Parts (for reference) |
|---------------|-------|-------------------------------------|------------------|------------------|------------------|------------------------------------|-----------------------------------|-----------|-----------|---------|---|
|               |       | A                                   | B                | C                | D                |                                    | @ 300 MHz                         | @ 500 MHz | @ 800 MHz | @ 1 GHz |   |
| HFA100035-0A2 | 1     | 13.00<br>(0.511)                    | 3.50<br>(0.138)  | 25.20<br>(0.992) | 11.50<br>(0.453) | 3.51<br>(0.138)                    | 172                               | 192       | 190       | 150     | HFB100035-000   |
| HFA100049-0A2 | 1     | 13.72<br>(0.540)                    | 5.44<br>(0.214)  | 30.56<br>(1.203) | 13.72<br>(0.540) | 4.88<br>(0.192)                    | 133                               | 152       | 168       | 162     | HFB095051-200   |
| HFA150066-0A2 | 2     | 18.15<br>(0.715)                    | 7.05<br>(0.278)  | 32.50<br>(1.280) | 18.90<br>(0.744) | 6.60<br>(0.260)                    | 274                               | 350       | 340       | 256     | HFB143064-200   |
| HFA150068-0A2 | 1     | 21.00<br>(0.827)                    | 6.80<br>(0.268)  | 41.70<br>(1.642) | 21.00<br>(0.827) | 6.76<br>(0.266)                    | 275                               | 340       | 281       | 200     | HFB150070-200   |
| HFA163090-0A2 | 1     | 19.10<br>(0.752)                    | 9.09<br>(0.358)  | 40.36<br>(1.589) | 20.80<br>(0.819) | 9.01<br>(0.355)                    | 210                               | 260       | 262       | 200     | HFB160093-300   |
| HFA187102-0A2 | 2     | 22.28<br>(0.877)                    | 10.00<br>(0.394) | 32.77<br>(1.290) | 21.84<br>(0.860) | 10.16<br>(0.400)                   | 220                               | 290       | 281       | 210     | HFB187102-100   |
| HFA259131-0A2 | 2     | 29.00<br>(1.142)                    | 13.00<br>(0.512) | 32.50<br>(1.280) | 29.62<br>(1.166) | 13.06<br>(0.514)                   | 250                               | 315       | 272       | 200     | HFB259128-100   |

All impedance values for high frequency cores are NET; NET impedance is impedance of the ferrite core only. All impedance contribution from the test wire and fixtures has been removed.

-0A2 = Black Plastic Snap-On Case  
- Other parts may be available.  
Please contact Laird.

## PLASTIC CASE SPLIT / SNAP-ON PART DIAGRAMS

Figure 1

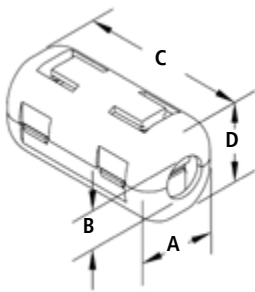

Figure 2

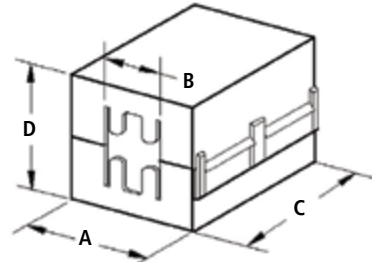

Figure 3

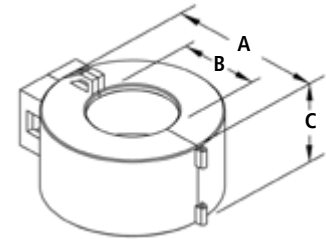

Figure 4

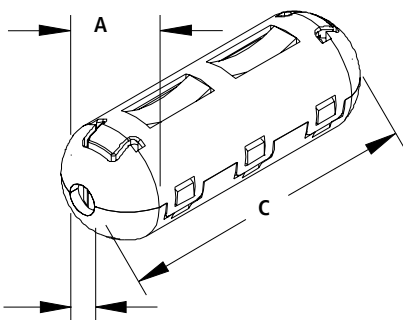
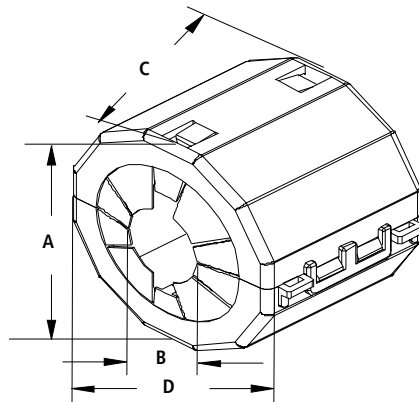

Figure 5



# REFERENCE CHART SORTED BY DIAMETER (B)

## BROADBAND 28 MATERIAL PARTS ONLY ONE-PIECE (28B) & SPLIT / SNAP-ON (28A) CORES FOR ROUND CABLES & WIRES

| PART NUMBER<br>Sorted by<br>Diameter (B) | DIMENSIONS in mm |      |       |       |
|--|------------------|------|-------|-------|
|  | A                | B    | C     | D     |
| 28B0141-000                              | 3.5              | 1.50 | 3.25  | -     |
| 28B0157-100                              | 4.00             | 2.00 | 10.00 | -     |
| 28B0296-000                              | 7.52             | 2.39 | 7.54  | -     |
| 28B0315-000                              | 8.00             | 3.17 | 4.78  | -     |
| 28B0315-100                              | 8.00             | 3.17 | 10.06 | -     |
| 28B0250-100                              | 6.35             | 3.18 | 15.88 | -     |
| 28B0250-700                              | 6.35             | 3.18 | 10.00 | -     |
| 28B0473-000                              | 12.00            | 3.55 | 10.00 | -     |
| 28B0473-200                              | 12.00            | 3.55 | 25.00 | -     |
| 28B0339-000                              | 8.60             | 3.80 | 10.00 | -     |
| 28B0384-000                              | 9.75             | 3.80 | 10.00 | -     |
| 28B0275-000                              | 7.00             | 3.80 | 13.50 | -     |
| 28B0384-200                              | 9.75             | 3.80 | 25.00 | -     |
| 28B0268-000                              | 6.78             | 3.99 | 14.22 | -     |
| 28B0474-000                              | 12.00            | 4.50 | 20.00 | -     |
| 28B0592-000                              | 15.00            | 4.50 | 40.00 | -     |
| 28B0355-000                              | 9.00             | 4.75 | 20.00 | -     |
| 28B0485-000                              | 12.32            | 4.88 | 25.40 | -     |
| 28A0350-0B2                              | 13.00            | 4.90 | 25.20 | 11.70 |
| 28B0453-000                              | 11.50            | 4.90 | 25.00 | -     |
| 28A2005-0A2                              | 13.00            | 5.00 | 25.50 | 11.70 |
| 28B0394-000                              | 10.00            | 5.00 | 5.00  | -     |
| 28A0592-0A2                              | 18.75            | 5.04 | 53.39 | 18.75 |
| 28B0375-400                              | 9.52             | 5.08 | 4.83  | -     |
| 28B0375-000                              | 9.53             | 5.08 | 10.41 | -     |
| 28B0375-100                              | 9.53             | 5.08 | 14.48 | -     |
| 28B0375-300                              | 9.53             | 5.08 | 19.05 | -     |

| PART NUMBER<br>Sorted by<br>Diameter (B) | DIMENSIONS in mm |      |       |       |
|--|------------------|------|-------|-------|
|  | A                | B    | C     | D     |
| 28B0434-000                              | 11.00            | 5.10 | 32.00 | -     |
| 28A0434-0A2                              | 14.71            | 5.44 | 43.03 | 14.70 |
| 28A0392-0A*                              | 13.72            | 5.44 | 30.56 | 13.72 |
| 28B0470-000                              | 12.00            | 5.60 | 20.00 | -     |
| 28B0591-200                              | 15.00            | 5.90 | 35.00 | -     |
| 28B0395-000                              | 10.01            | 5.97 | 6.17  | -     |
| 28B0562-000                              | 14.27            | 6.35 | 10.16 | -     |
| 28B0562-100                              | 14.27            | 6.35 | 13.46 | -     |
| 28B0390-200                              | 9.91             | 6.35 | 15.00 | -     |
| 28B0562-300                              | 14.27            | 6.35 | 28.32 | -     |
| 28B0562-500                              | 14.27            | 6.35 | 38.00 | -     |
| 28B0562-200                              | 14.27            | 6.35 | 28.58 | -     |
| 28A0593-0A2                              | 18.75            | 6.75 | 52.91 | 18.75 |
| 28A2026-0A2                              | 21.00            | 6.80 | 41.70 | 21.00 |
| 28B0590-000                              | 14.99            | 6.99 | 27.94 | -     |
| 28B0616-000                              | 15.65            | 6.99 | 28.58 | -     |
| 28A1507-0A2                              | 15.00            | 7.00 | 18.00 | 22.00 |
| 28A2307-0A2                              | 16.50            | 7.00 | 30.50 | 15.25 |
| 28A2025-0A*                              | 18.15            | 7.05 | 32.50 | 18.90 |
| 28B0563-000                              | 14.27            | 7.26 | 15.24 | -     |
| 28B0563-100                              | 14.27            | 7.26 | 20.30 | -     |
| 28B0563-200                              | 14.27            | 7.26 | 28.57 | -     |
| 28B0452-000                              | 11.70            | 7.70 | 15.00 | -     |
| 28B0625-000                              | 15.88            | 7.87 | 14.27 | -     |
| 28B0625-100                              | 15.88            | 7.87 | 28.58 | -     |
| 28B0500-100                              | 12.70            | 7.92 | 6.35  | -     |
| 28B0500-300                              | 12.70            | 7.92 | 12.70 | -     |
| 28A2432-0A2                              | 19.20            | 8.20 | 19.90 | 23.10 |
| 28B0570-000                              | 14.48            | 8.51 | 5.51  | -     |
| 28B0672-000                              | 17.07            | 8.76 | 25.40 | -     |

Refer to pages 6, 7, 8 & 9 for more broadband data.

All chart data can be sorted on [lairdtech.com](http://lairdtech.com).

# REFERENCE CHART SORTED BY DIAMETER (B)

## BROADBAND 28 MATERIAL PARTS ONLY ONE-PIECE (28B) & SPLIT / SNAP-ON (28A) CORES FOR ROUND CABLES & WIRES

| PART NUMBER<br>Sorted by<br>Diameter (B) | DIMENSIONS in mm |       |       |       |
|--|------------------|-------|-------|-------|
|  | A                | B     | C     | D     |
| 28A2736-0A2                              | 19.70            | 9.00  | 35.10 | 18.00 |
| 28A2809-0A2                              | 19.70            | 9.00  | 35.25 | 18.25 |
| 28A0640-0A*                              | 20.07            | 9.07  | 41.55 | 21.57 |
| 28B0631-000                              | 16.00            | 9.25  | 11.99 | -     |
| 28B0631-100                              | 16.00            | 9.25  | 27.99 | -     |
| 28B0686-000                              | 17.42            | 9.52  | 6.35  | -     |
| 28B0686-100                              | 17.42            | 9.52  | 12.70 | -     |
| 28B0686-200                              | 17.42            | 9.53  | 28.58 | -     |
| 28A2029-0A*                              | 22.28            | 10.00 | 32.77 | 21.84 |
| 28B0629-000                              | 16.00            | 10.00 | 16.00 | -     |
| 28B0735-300                              | 18.67            | 10.16 | 14.27 | -     |
| 28B0735-000                              | 18.67            | 10.16 | 28.58 | -     |
| 28A3039-0A2                              | 24.55            | 10.20 | 13.60 | 28.50 |
| 28B0734-000                              | 18.67            | 11.18 | 28.58 | -     |
| 28B1000-000                              | 25.40            | 12.70 | 12.70 | -     |
| 28B1020-100                              | 25.91            | 12.83 | 28.58 | -     |
| 28B1531-000                              | 38.86            | 12.95 | 28.58 | 26.16 |
| 28A2024-0A*                              | 29.00            | 13.00 | 32.50 | 29.62 |
| 28A3851-0A2                              | 30.00            | 13.00 | 33.70 | 30.00 |
| 28A2913-0A2                              | 23.50            | 13.06 | 36.25 | 22.00 |
| 28B0825-000                              | 20.95            | 13.21 | 6.35  | -     |
| 28A4155-0A2                              | 28.80            | 13.60 | 15.40 | 33.20 |
| 28B0870-000                              | 22.10            | 13.72 | 6.35  | -     |
| 28B0870-100                              | 22.10            | 13.72 | 12.70 | -     |
| 28B1122-300                              | 28.50            | 13.77 | 20.00 | -     |
| 28B1122-100                              | 28.50            | 13.77 | 28.58 | -     |
| 28B0886-20H                              | 22.80            | 13.80 | 8.80  | -     |
| 28B0999-000                              | 25.40            | 15.49 | 12.70 | -     |

| PART NUMBER<br>Sorted by<br>Diameter (B) | DIMENSIONS in mm |       |       |       |
|--|------------------|-------|-------|-------|
|  | A                | B     | C     | D     |
| 28B1540-000                              | 39.12            | 16.76 | 22.22 | -     |
| 28B1142-000                              | 29.01            | 19.00 | 7.49  | -     |
| 28B1142-100                              | 29.01            | 19.00 | 13.84 | -     |
| 28B1225-100                              | 31.12            | 19.05 | 7.92  | -     |
| 28B1225-300                              | 31.12            | 19.05 | 10.00 | -     |
| 28B1225-000                              | 31.12            | 19.05 | 15.93 | -     |
| 28B1250-000                              | 31.75            | 19.05 | 22.22 | -     |
| 28A5776-0A2                              | 29.20            | 19.30 | 42.00 | 29.40 |
| 28A5131-0A2                              | 56.64            | 19.50 | 45.00 | 56.63 |
| 28A5776-0A2                              | 29.20            | 20.00 | 42.00 | 29.40 |
| 28B1417-200                              | 36.00            | 23.00 | 12.70 | -     |
| 28B2000-100                              | 50.80            | 25.40 | 28.70 | -     |
| 28B2400-000                              | 60.96            | 35.56 | 12.70 | -     |

Refer to pages 6, 7, 8 & 9 for more broadband data.

All chart data can be sorted on [lairdtech.com](http://lairdtech.com).

# REFERENCE CHART

## SORTED BY IMPEDANCE @ 100 MHZ

### BROADBAND 28 MATERIAL PARTS ONLY

### ONE-PIECE (28B) & SPLIT / SNAP-ON (28A) CORES FOR ROUND CABLES & WIRES

| PART NUMBER<br>Sorted by<br>Impedance | Typical Impedance (Z)<br>in Ohms ( $\Omega$ ) |              |              |
|---------------------------------------|---|--------------|--------------|
|                                       | @ 25<br>MHz                                   | @ 100<br>MHz | @ 300<br>MHz |
| 28B0141-000                           | 30  | 79           | 192          |
| 28B0825-000                           | 31  | 79           | 204          |
| 28B0375-400                           | 33  | 81           | 200          |
| 28B0570-000                           | 32  | 82           | 200          |
| 28B0395-000                           | 31  | 83           | 199          |
| 28B0500-100                           | 33  | 83           | 200          |
| 28B1142-000                           | 34  | 85           | 200          |
| 28B0870-000                           | 34  | 85           | 205          |
| 28B0394-000                           | 34  | 86           | 201          |
| 28B0886-20H                           | 37  | 90           | 199          |
| 28B0686-000                           | 39  | 91           | 214          |
| 28B1225-100                           | 39  | 93           | 210          |
| 28B0315-000                           | 43  | 100          | 220          |
| 28B1225-300                           | 46  | 110          | 240          |
| 28B1142-100                           | 54  | 114          | 235          |
| 28B1417-200                           | 52  | 115          | 230          |
| 28B0452-000                           | 52  | 116          | 235          |
| 28B0500-300                           | 54  | 118          | 230          |
| 28A4155-0A2                           | 50  | 120          | 230          |
| 28B0157-100                           | 67  | 121          | 236          |
| 28B0870-100                           | 56  | 122          | 236          |
| 28B0999-000                           | 56  | 122          | 247          |
| 28A1507-0A2                           | 56  | 123          | 246          |
| 28B0375-000                           | 57  | 125          | 245          |
| 28B0390-200                           | 57  | 128          | 248          |
| 28B0629-000                           | 60  | 129          | 248          |
| 28A3039-0A2                           | 55  | 130          | 250          |
| 28B0631-000                           | 60  | 130          | 250          |

| PART NUMBER<br>Sorted by<br>Impedance | Typical Impedance (Z)<br>in Ohms ( $\Omega$ ) |              |              |
|---------------------------------------|---|--------------|--------------|
|                                       | @ 25<br>MHz                                   | @ 100<br>MHz | @ 300<br>MHz |
| 28B0250-700                           | 64  | 135          | 255          |
| 28B2400-000                           | 60  | 135          | 285          |
| 28B0268-000                           | 65  | 138          | 260          |
| 28B0686-100                           | 66  | 139          | 265          |
| 28B1225-000                           | 68  | 140          | 270          |
| 28B0339-000                           | 68  | 143          | 264          |
| 28B0562-000                           | 69  | 145          | 270          |
| 28B0275-000                           | 69  | 146          | 268          |
| 28B0735-300                           | 73  | 150          | 270          |
| 28B1000-000                           | 73  | 151          | 278          |
| 28B0375-100                           | 74  | 154          | 282          |
| 28B0315-100                           | 76  | 158          | 281          |
| 28B0384-000                           | 82  | 159          | 286          |
| 28B0296-000                           | 75  | 160          | 270          |
| 28A2432-0A2                           | 62  | 160          | 300          |
| 28B0625-000                           | 79  | 163          | 273          |
| 28A0392-0A*                           | 75  | 170          | 320          |
| 28B0563-000                           | 85  | 173          | 295          |
| 28A2913-0A2                           | 86  | 177          | 305          |
| 28B0250-100                           | 90  | 182          | 300          |
| 28A2307-0A2                           | 92  | 183          | 315          |
| 28B0562-100                           | 89  | 184          | 303          |
| 28B1250-000                           | 92  | 186          | 292          |
| 28A2005-0A2                           | 88  | 190          | 330          |
| 28B0375-300                           | 100   | 194          | 310          |
| 28B0473-000                           | 101   | 195          | 320          |

Refer to pages 6, 7, 8 & 9 for more broadband data.

Custom parts are also available

REFERENCE CHART

SORTED BY IMPEDANCE @ 100 MHZ

**BROADBAND 28 MATERIAL PARTS ONLY**

**ONE-PIECE (28B) & SPLIT / SNAP-ON (28A) CORES FOR ROUND CABLES & WIRES**

| PART NUMBER<br>Sorted by<br>Impedance | Typical Impedance (Z)<br>in Ohms ( $\Omega$ ) |              |              |
|---------------------------------------|---|--------------|--------------|
|                                       | @ 25<br>MHz                                   | @ 100<br>MHz | @ 300<br>MHz |
| 28B0355-000                           | 110   | 205          | 360          |
| 28B1531-000                           | 109   | 210          | 347          |
| 28B1122-300                           | 115   | 210          | 350          |
| 28A5776-0A2                           | 115   | 210          | 360          |
| 28B0470-000                           | 109   | 211          | 344          |
| 28B0563-100                           | 109   | 217          | 333          |
| 28A2736-0A2                           | 120   | 220          | 360          |
| 28A2809-0A2                           | 120   | 220          | 360          |
| 28B0734-000                           | 116   | 229          | 370          |
| 28A2738-0A2                           | 106   | 233          | 366          |
| 28A5776-0A2                           | 115   | 240          | 360          |
| 28A0350-0B2                           | 100   | 240          | 400          |
| 28A0640-0A*                           | 105   | 240          | 390          |
| 28B0686-200                           | 124   | 242          | 390          |
| 28B0631-100                           | 124   | 243          | 370          |
| 28B0474-000                           | 138   | 245          | 370          |
| 28B0672-000                           | 130   | 245          | 360          |
| 28B0735-000                           | 135   | 250          | 400          |
| 28A2029-0A*                           | 95  | 250          | 420          |
| 28B1540-000                           | 130   | 254          | 405          |
| 28A3851-0A2                           | 150   | 260          | 410          |
| 28B0453-000                           | 148   | 262          | 378          |
| 28B0562-300                           | 150   | 270          | 420          |
| 28A2026-0A2                           | 95  | 270          | 460          |
| 28B1020-100                           | 147   | 276          | 412          |

| PART NUMBER<br>Sorted by<br>Impedance | Typical Impedance (Z)<br>in Ohms ( $\Omega$ ) |              |              |
|---------------------------------------|---|--------------|--------------|
|                                       | @ 25<br>MHz                                   | @ 100<br>MHz | @ 300<br>MHz |
| 28A0434-0A2                           | 111   | 277          | 449          |
| 28B0625-100                           | 150   | 280          | 400          |
| 28A2024-0A*                           | 130   | 280          | 440          |
| 28A2024-0A0                           | 130   | 280          | 440          |
| 28A2024-0A2                           | 130   | 280          | 440          |
| 28B0563-200                           | 149   | 287          | 406          |
| 28B0562-200                           | 159   | 294          | 439          |
| 28B0590-000                           | 170   | 300          | 450          |
| 28B2000-100                           | 157   | 305          | 442          |
| 28B1122-100                           | 160   | 307          | 440          |
| 28B0616-000                           | 170   | 310          | 450          |
| 28B0485-000                           | 170   | 320          | 450          |
| 28A2025-0A*                           | 130   | 320          | 510          |
| 28B0384-200                           | 182   | 322          | 473          |
| 28B0434-000                           | 200   | 349          | 481          |
| 28B0562-500                           | 196   | 358          | 487          |
| 28B0591-200                           | 207   | 377          | 508          |
| 28B0562-600                           | 220   | 399          | 531          |
| 28A0593-0A2                           | 186   | 407          | 575          |
| 28B0473-200                           | 270   | 424          | 558          |
| 28A5131-0A2                           | 187   | 425          | 533          |
| 28A5131-0A4                           | 187   | 425          | 533          |
| 28A0592-0A2                           | 232   | 511          | 627          |
| 28B0592-000                           | 361   | 653          | 627          |

Refer to pages 6, 7, 8 & 9 for more broadband data.

Custom parts are also available



# LOW FREQUENCY FERRITE EMI CORES

## FOR ROUND CABLES & WIRING HARNESSES 300 KHZ TO 30 MHZ OPTIMIZED

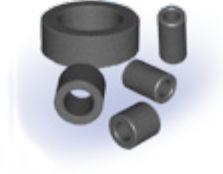

### PART NUMBERING SYSTEM EXAMPLE

|               |              |                |  |                             |   |
|---------------|--------------|----------------|--|-----------------------------|---|
| <b>LF</b>     | <b>B</b>     | <b>090050</b>  | <b>-0</b>                                | <b>0</b>                    | <b>0</b>                                    |
| Material Type | Product Code | Part Size Code | Selected Dimension Code (Usually Length) | Additional Part Description | Additional Part Description or Coating Code |

| PART NUMBER   | DIMENSIONS<br>mm<br>(inches) |                  |                  | Typical Impedance (Z) in Ohms (Ω) |     |      |                 |     |      |           |     |      |
|---------------|------------------------------|------------------|------------------|-----------------------------------|-----|------|-----------------|-----|------|-----------|-----|------|
|               |                              |                  |                  | Ω @ 500 KHz                       |     |      | Ω @ 1 MHz       |     |      | Ω @ 5 MHz |     |      |
|               | # of Wire Turns              |                  |                  | # of Wire Turns                   |     |      | # of Wire Turns |     |      |           |     |      |
|               | A                            | B                | C                | 1                                 | 2   | 5    | 1               | 2   | 5    | 1         | 2   | 5    |
| LFB090050-000 | 9.00<br>(0.354)              | 5.00<br>(0.197)  | 7.00<br>(0.275)  | 12                                | 58  | 370  | 21              | 90  | 558  | 36        | 140 | 867  |
| LFB095051-000 | 9.50<br>(0.374)              | 5.10<br>(0.201)  | 19.05<br>(0.750) | 36                                | 150 | 846  | 63              | 240 | 1464 | 86        | 340 | 2514 |
| LFB127079-000 | 12.70<br>(0.500)             | 7.92<br>(0.312)  | 7.00<br>(0.276)  | 9                                 | 45  | 301  | 16              | 70  | 436  | 25        | 102 | 593  |
| LFB143064-000 | 14.27<br>(0.562)             | 6.35<br>(0.250)  | 28.58<br>(1.125) | 70                                | 290 | 1757 | 122             | 490 | 2842 | 120       | 480 | 2646 |
| LFB143064-100 | 14.27<br>(0.562)             | 6.35<br>(0.250)  | 13.46<br>(0.530) | 33                                | 145 | 626  | 57              | 220 | 1169 | 53        | 215 | 1552 |
| LFB159079-000 | 15.88<br>(0.625)             | 7.87<br>(0.310)  | 28.58<br>(1.125) | 61                                | 250 | 1605 | 105             | 410 | 2615 | 100       | 390 | 2305 |
| LFB174095-000 | 17.40<br>(0.685)             | 9.50<br>(0.374)  | 28.58<br>(1.125) | 52                                | 200 | 1290 | 91              | 350 | 2184 | 85        | 340 | 2044 |
| LFB180100-000 | 18.10<br>(0.713)             | 10.00<br>(0.394) | 10.00<br>(0.394) | 18                                | 75  | 493  | 31              | 138 | 809  | 29        | 115 | 722  |
| LFB187102-000 | 18.67<br>(0.735)             | 10.16<br>(0.400) | 28.58<br>(1.125) | 53                                | 200 | 1182 | 91              | 350 | 1969 | 84        | 330 | 1863 |
| LFB220140-000 | 22.10<br>(0.870)             | 14.00<br>(0.551) | 12.70<br>(0.500) | 18                                | 72  | 469  | 30              | 120 | 818  | 28        | 110 | 699  |
| LFB250150-000 | 25.00<br>(0.984)             | 15.00<br>(0.591) | 13.00<br>(0.512) | 16                                | 70  | 562  | 34              | 105 | 850  | 26        | 80  | 624  |
| LFB259128-000 | 25.91<br>(1.020)             | 12.83<br>(0.505) | 28.58<br>(1.125) | 61                                | 220 | 1446 | 106             | 420 | 2647 | 62        | 240 | 1487 |
| LFB290190-000 | 28.98<br>(1.141)             | 19.05<br>(0.750) | 15.21<br>(0.599) | 19                                | 90  | 533  | 34              | 155 | 963  | 22        | 70  | 513  |
| LFB310190-000 | 31.00<br>(1.220)             | 19.00<br>(0.748) | 13.00<br>(0.512) | 19                                | 80  | 523  | 33              | 143 | 845  | 22        | 88  | 554  |
| LFB360230-300 | 36.00<br>(1.417)             | 23.00<br>(0.905) | 15.00<br>(0.591) | 24                                | 96  | 614  | 27              | 110 | 653  | 19        | 75  | 438  |

All impedance values for high frequency cores are NET; NET impedance is impedance of the ferrite core only. All impedance contribution from the test wire and fixtures has been removed.

This catalog lists a limited sample of available parts. Custom parts are also available..

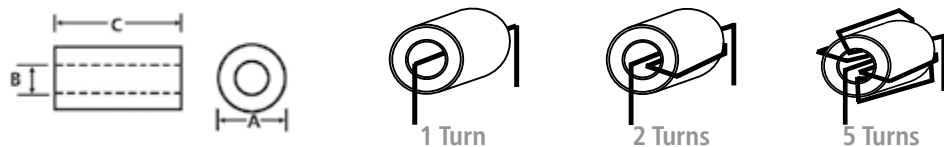

# BROADBAND FERRITE EMI CORES

## FOR RIBBON & FLEX CABLES



### PART NUMBERING SYSTEM EXAMPLE

|               |              |                |  |                             |   |
|---------------|--------------|----------------|--|-----------------------------|---|
| <b>28</b>     | <b>R</b>     | <b>0315</b>    | <b>-2</b>                                | <b>0</b>                    | <b>0</b>                                    |
| Material Type | Product Code | Part Size Code | Selected Dimension Code (Usually Length) | Additional Part Description | Additional Part Description or Coating Code |

| PART NUMBER | Fig # on page 19 | DIMENSIONS mm (inches) |                  |                  |                 |                 | Typical Impedance (Z) in Ohms (Ω) |           |           |
|-------------|------------------|------------------------|------------------|------------------|-----------------|-----------------|-----------------------------------|-----------|-----------|
|             |                  | A                      | B                | C*               | D               | E               | @ 25 MHz                          | @ 100 MHz | @ 300 MHz |
| 28R0315-200 | 2                | 8.00<br>(0.315)        | 6.00<br>(0.236)  | 12.00<br>(0.472) | 2.70<br>(0.106) | 0.70<br>(0.028) | 48                                | 102       | 250       |
| 28R0394-000 | 2                | 10.00<br>(0.394)       | 7.00<br>(0.276)  | 25.00<br>(0.984) | 5.00<br>(0.197) | 2.00<br>(0.079) | 92                                | 169       | 294       |
| 28R0453-200 | 2                | 11.50<br>(0.453)       | 8.00<br>(0.315)  | 12.00<br>(0.472) | 3.00<br>(0.118) | 0.70<br>(0.028) | 43                                | 104       | 260       |
| 28R0453-300 | 2                | 11.50<br>(0.453)       | 8.00<br>(0.315)  | 20.00<br>(0.787) | 3.00<br>(0.118) | 0.70<br>(0.028) | 72                                | 160       | 330       |
| 28R0480-000 | 2                | 12.20<br>(0.480)       | 8.00<br>(0.315)  | 18.00<br>(0.709) | 5.50<br>(0.217) | 1.00<br>(0.039) | 100                               | 190       | 320       |
| 28R0480-100 | 2                | 12.20<br>(0.480)       | 8.00<br>(0.315)  | 12.00<br>(0.472) | 5.50<br>(0.217) | 1.00<br>(0.039) | 68                                | 150       | 290       |
| 28R0492-100 | 2                | 12.50<br>(0.492)       | 8.30<br>(0.327)  | 12.00<br>(0.472) | 5.50<br>(0.217) | 1.00<br>(0.039) | 68                                | 150       | 290       |
| 28R0610-000 | 3                | 15.50<br>(0.610)       | 13.50<br>(0.531) | 10.00<br>(0.394) | 3.40<br>(0.134) | 1.40<br>(0.055) | 29                                | 80        | 216       |
| 28R0614-100 | 2                | 15.60<br>(0.614)       | 13.60<br>(0.535) | 12.00<br>(0.472) | 2.80<br>(0.110) | 0.70<br>(0.028) | 36                                | 98        | 245       |
| 28R0614-300 | 2                | 15.60<br>(0.614)       | 13.60<br>(0.535) | 18.00<br>(0.709) | 2.80<br>(0.110) | 0.70<br>(0.028) | 45                                | 125       | 280       |
| 28R0669-000 | 2                | 17.00<br>(0.669)       | 13.00<br>(0.512) | 12.00<br>(0.472) | 3.50<br>(0.138) | 0.75<br>(0.030) | 41                                | 110       | 270       |
| 28R0756-000 | 3                | 19.20<br>(0.756)       | 15.00<br>(0.591) | 10.00<br>(0.394) | 5.35<br>(0.211) | 1.15<br>(0.045) | 40                                | 107       | 258       |

Custom parts with double sided mounting tape are available.

\*Broadband (28) ribbon and flex cable cores are sorted by slot width on pages 22 & 23 and sorted by impedance on pages 24 & 25.

# BROADBAND FERRITE EMI CORES FOR RIBBON & FLEX CABLES

## PART NUMBERING SYSTEM EXAMPLE



|               |              |                |  |                             |   |
|---------------|--------------|----------------|--|-----------------------------|---|
| <b>28</b>     | <b>R</b>     | <b>0315</b>    | <b>-2</b>                                | <b>0</b>                    | <b>0</b>                                    |
| Material Type | Product Code | Part Size Code | Selected Dimension Code (Usually Length) | Additional Part Description | Additional Part Description or Coating Code |

| PART NUMBER | Fig # on page 19 | DIMENSIONS mm (inches) |                   |                  |                 |                 | Typical Impedance (Z) in Ohms (Ω) |           |           |
|-------------|------------------|------------------------|-------------------|------------------|-----------------|-----------------|-----------------------------------|-----------|-----------|
|             |                  | A                      | B                 | C*               | D               | E               | @ 25 MHz                          | @ 100 MHz | @ 300 MHz |
| 28R0756-200 | 3                | 19.20<br>(0.756)       | 15.00<br>(0.591)  | 16.00<br>(0.630) | 5.35<br>(0.211) | 1.15<br>(0.045) | 57                                | 140       | 308       |
| 28R0852-500 | 3                | 21.65<br>(0.852)       | 17.50<br>(0.689)  | 5.50<br>(0.317)  | 5.15<br>(0.203) | 1.00<br>(0.039) | 28                                | 83        | 210       |
| 28R0880-000 | 2                | 22.35<br>(0.880)       | 14.00<br>(0.551)  | 19.05<br>(0.750) | 7.75<br>(0.305) | 1.50<br>(0.059) | 93                                | 187       | 356       |
| 28R0900-100 | 2                | 22.80<br>(0.898)       | 18.70<br>(0.736)  | 12.00<br>(0.472) | 3.60<br>(0.142) | 0.70<br>(0.028) | 38                                | 116       | 266       |
| 28R0945-000 | 3                | 24.00<br>(0.945)       | 19.00<br>(0.748)  | 10.00<br>(0.394) | 6.25<br>(0.246) | 1.25<br>(0.049) | 43                                | 112       | 269       |
| 28R0983-000 | 3                | 25.00<br>(0.984)       | 21.00<br>(0.827)  | 15.00<br>(0.590) | 3.00<br>(0.118) | 0.80<br>(0.031) | 43                                | 123       | 276       |
| 28R0984-000 | 3                | 25.00<br>(0.984)       | 18.00<br>(0.709)  | 24.00<br>(0.945) | 7.70<br>(0.303) | 0.90<br>(0.035) | 100                               | 220       | 430       |
| 28R0984-200 | 3                | 25.00<br>(0.984)       | 18.00<br>(0.709)  | 16.00<br>(0.630) | 7.70<br>(0.303) | 0.90<br>(0.035) | 70                                | 170       | 370       |
| 28R1022-000 | 3                | 26.00<br>(1.022)       | 22.00<br>(0.866)  | 9.00<br>(0.354)  | 5.00<br>(0.197) | 1.20<br>(0.047) | 32                                | 91        | 227       |
| 28R1024-000 | 2                | 26.00<br>(1.024)       | 20.50<br>(0.807)  | 10.00<br>(0.394) | 6.00<br>(0.236) | 0.80<br>(0.031) | 48                                | 128       | 299       |
| 28R1025-000 | 3                | 26.00<br>(1.024)       | 21.40<br>(0.8425) | 10.00<br>(0.394) | 5.00<br>(0.197) | 0.75<br>(0.030) | 34                                | 97        | 242       |
| 28R1101-000 | 1                | 27.97<br>(1.101)       | 22.94<br>(0.903)  | 14.66<br>(0.577) | 7.75<br>(0.305) | 1.50<br>(0.059) | 55                                | 140       | 300       |
| 28R1102-000 | 2                | 28.00<br>(1.102)       | 23.00<br>(0.906)  | 15.00<br>(0.591) | 5.80<br>(0.228) | 0.80<br>(0.031) | 61                                | 154       | 340       |
| 28R1102-100 | 2                | 28.00<br>(1.102)       | 23.00<br>(0.906)  | 20.00<br>(0.787) | 5.80<br>(0.228) | 0.80<br>(0.031) | 75                                | 192       | 380       |
| 28R1103-000 | 2                | 28.00<br>(1.102)       | 23.00<br>(0.906)  | 27.00<br>(1.063) | 6.10<br>(0.240) | 1.10<br>(0.043) | 95                                | 230       | 480       |
| 28R1127-000 | 3                | 28.58<br>(1.125)       | 23.50<br>(0.925)  | 31.00<br>(1.220) | 7.70<br>(0.303) | 1.70<br>(0.067) | 100                               | 220       | 430       |

# BROADBAND FERRITE EMI CORES FOR RIBBON & FLEX CABLES

## PART NUMBERING SYSTEM EXAMPLE



|               |              |                |  |                             |   |
|---------------|--------------|----------------|--|-----------------------------|---|
| <b>28</b>     | <b>R</b>     | <b>0315</b>    | <b>-2</b>                                | <b>0</b>                    | <b>0</b>                                    |
| Material Type | Product Code | Part Size Code | Selected Dimension Code (Usually Length) | Additional Part Description | Additional Part Description or Coating Code |

| PART NUMBER | Fig # on page 19 | DIMENSIONS mm (inches) |               |               |               |              | Typical Impedance (Z) in Ohms (Ω) |           |           |
|-------------|------------------|------------------------|---------------|---------------|---------------|--------------|-----------------------------------|-----------|-----------|
|             |                  | A                      | B             | C*            | D             | E            | @ 25 MHz                          | @ 100 MHz | @ 300 MHz |
| 28R1127-200 | 3                | 28.58 (1.125)          | 23.50 (0.925) | 24.89 (0.980) | 7.70 (0.303)  | 1.70 (0.067) | 85                                | 191       | 410       |
| 28R1127-400 | 3                | 28.58 (1.125)          | 23.50 (0.925) | 17.00 (0.669) | 7.70 (0.303)  | 1.70 (0.067) | 60                                | 150       | 330       |
| 28R1127-500 | 3                | 28.58 (1.125)          | 23.50 (0.925) | 9.70 (0.382)  | 7.70 (0.303)  | 1.70 (0.067) | 40                                | 110       | 265       |
| 28R1128-100 | 3                | 28.58 (1.125)          | 24.00 (0.945) | 26.00 (1.024) | 5.38 (0.212)  | 0.80 (0.031) | 79                                | 204       | 399       |
| 28R1128-200 | 3                | 28.58 (1.125)          | 24.00 (0.945) | 14.00 (0.551) | 5.38 (0.212)  | 0.80 (0.031) | 52                                | 145       | 312       |
| 28R1227-100 | 2                | 31.12 (1.225)          | 24.77 (0.975) | 13.30 (0.525) | 8.26 (0.325)  | 1.91 (0.075) | 52                                | 128       | 300       |
| 28R1236-000 | 2                | 31.40 (1.236)          | 23.00 (0.906) | 19.00 (0.748) | 7.75 (0.305)  | 1.50 (0.059) | 78                                | 162       | 370       |
| 28R1261-100 | 3                | 32.00 (1.260)          | 25.10 (0.988) | 35.00 (1.378) | 7.75 (0.305)  | 0.90 (0.035) | 140                               | 350       | 700       |
| 28R1262-000 | 2                | 32.00 (1.260)          | 26.00 (1.024) | 30.00 (1.181) | 7.00 (0.276)  | 1.00 (0.039) | 110                               | 260       | 520       |
| 28R1262-200 | 2                | 32.00 (1.260)          | 26.00 (1.024) | 13.00 (0.512) | 7.00 (0.276)  | 1.00 (0.039) | 53                                | 141       | 344       |
| 28R1300-000 | 3                | 33.02 (1.300)          | 28.50 (1.122) | 3.00 (0.118)  | 5.00 (0.197)  | 0.59 (0.023) | 21                                | 72        | 200       |
| 28R1319-000 | 3                | 33.50 (1.312)          | 27.00 (1.063) | 12.00 (0.472) | 6.50 (0.256)  | 1.50 (0.059) | 43                                | 117       | 269       |
| 28R1340-100 | 3                | 34.00 (1.340)          | 28.00 (1.100) | 12.00 (0.472) | 7.00 (0.280)  | 1.00 (0.039) | 50                                | 139       | 315       |
| 28R1340-200 | 3                | 34.00 (1.340)          | 28.00 (1.100) | 25.00 (0.984) | 7.00 (0.280)  | 1.00 (0.039) | 86                                | 220       | 449       |
| 28R1417-000 | 2                | 36.00 (1.417)          | 26.00 (1.024) | 40.00 (1.575) | 11.00 (0.433) | 1.00 (0.039) | 187                               | 393       | 734       |
| 28R1418-000 | 3                | 36.00 (1.417)          | 33.00 (1.299) | 10.00 (0.394) | 4.00 (0.157)  | 1.00 (0.039) | 34                                | 104       | 245       |
| 28R1450-100 | 3                | 36.83 (1.450)          | 29.58 (1.165) | 10.00 (0.394) | 7.75 (0.305)  | 0.75 (0.030) | 48                                | 130       | 290       |

# BROADBAND FERRITE EMI CORES FOR RIBBON & FLEX CABLE



## PART NUMBERING SYSTEM EXAMPLE

|               |              |                |  |                             |   |
|---------------|--------------|----------------|--|-----------------------------|---|
| <b>28</b>     | <b>R</b>     | <b>0315</b>    | <b>-2</b>                                | <b>0</b>                    | <b>0</b>                                    |
| Material Type | Product Code | Part Size Code | Selected Dimension Code (Usually Length) | Additional Part Description | Additional Part Description or Coating Code |

| PART NUMBER | Fig # on page 19 | DIMENSIONS mm (inches) |               |               |               |              | Typical Impedance (Z) in Ohms (Ω) |           |           |
|-------------|------------------|------------------------|---------------|---------------|---------------|--------------|-----------------------------------|-----------|-----------|
|             |                  | A                      | B             | C*            | D             | E            | @ 25 MHz                          | @ 100 MHz | @ 300 MHz |
| 28R1457-400 | 3                | 37.01 (1.457)          | 33.00 (1.299) | 13.46 (0.530) | 4.50 (0.177)  | 0.51 (0.020) | 44                                | 140       | 310       |
| 28R1476-100 | 3                | 37.50 (1.476)          | 34.50 (1.358) | 13.00 (0.512) | 4.00 (0.157)  | 1.00 (0.039) | 38                                | 110       | 251       |
| 28R1496-000 | 2                | 38.00 (1.496)          | 30.00 (1.181) | 25.00 (0.984) | 9.25 (0.364)  | 1.25 (0.049) | 91                                | 239       | 479       |
| 28R1517-000 | 2                | 38.10 (1.500)          | 26.67 (1.050) | 25.40 (1.000) | 12.07 (0.475) | 1.91 (0.075) | 110                               | 230       | 520       |
| 28R1518-000 | 1                | 38.50 (1.516)          | 26.80 (1.055) | 25.40 (1.000) | 12.09 (0.476) | 1.91 (0.075) | 105                               | 235       | 478       |
| 28R1775-000 | 2                | 45.08 (1.775)          | 34.42 (1.355) | 28.58 (1.125) | 12.45 (0.490) | 1.52 (0.060) | 115                               | 260       | 530       |
| 28R1779-000 | 2                | 63.50 (2.500)          | 52.07 (2.050) | 28.58 (1.125) | 12.70 (0.500) | 1.68 (0.066) | 114                               | 298       | 588       |
| 28R1779-100 | 2                | 63.50 (2.500)          | 52.07 (2.050) | 12.98 (0.511) | 12.70 (0.500) | 1.68 (0.066) | 65                                | 170       | 375       |
| 28R1862-000 | 2                | 47.70 (1.878)          | 39.00 (1.535) | 31.00 (1.220) | 15.00 (0.590) | 3.00 (0.118) | 116                               | 261       | 561       |
| 28R1953-000 | 3                | 49.61 (1.953)          | 44.00 (1.732) | 12.00 (0.472) | 7.62 (0.300)  | 1.45 (0.057) | 45                                | 127       | 300       |
| 28R2000-200 | 2                | 50.80 (2.000)          | 40.60 (1.600) | 28.00 (1.102) | 12.20 (0.480) | 2.00 (0.079) | 103                               | 252       | 545       |
| 28R2170-000 | 2                | 55.12 (2.170)          | 43.69 (1.720) | 25.40 (1.000) | 12.70 (0.500) | 1.27 (0.050) | 110                               | 280       | 550       |
| 28R2170-100 | 2                | 55.12 (2.170)          | 43.69 (1.720) | 12.70 (0.500) | 12.70 (0.500) | 1.27 (0.050) | 62                                | 170       | 370       |
| 28R3149-000 | 2                | 79.98 (3.149)          | 68.58 (2.700) | 12.70 (0.500) | 11.99 (0.472) | 1.91 (0.075) | 51                                | 135       | 318       |

\*Broadband (28) ribbon and flex cable cores are sorted by slot width on pages 22 & 23 and sorted by impedance on pages 24 & 25.

Ferrite core shape and size affect frequency response and impedance.

Please visit [lairdtech.com](http://lairdtech.com) for the most up to date information. All dimensions & impedance values can be sorted and compared on [lairdtech.com](http://lairdtech.com). Custom parts are available.

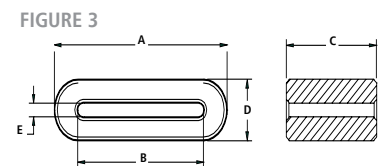
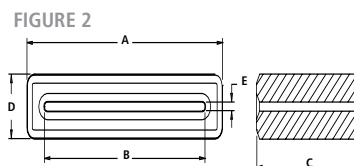
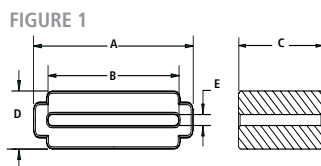

# BROADBAND SPLIT FERRITE CORES FOR RIBBON & FLEX CABLES



Laird Technologies offers a selection of broadband “split” ribbon and flex cores for retrofit and post-assembly operations. Similar in performance to one-piece core designs, these split ferrite cores provide excellent differential and common mode EMI suppression on flat cable assemblies. Lightweight, inexpensive metal or plastic end clips and cases provide secure closure of the ferrite onto the flat cable.

### PART NUMBERING SYSTEM EXAMPLE

|               |              |                |  |                   |                             |
|---------------|--------------|----------------|--|-------------------|-----------------------------|
| <b>28</b>     | <b>S</b>     | <b>0670</b>    | <b>-0</b>                                | <b>0*</b>         | <b>0</b>                    |
| Material Type | Product Code | Part Size Code | Selected Dimension Code (Usually Length) | Case or Clip Code | Additional Part Description |

- \*0 = No End Clip
- \*M = Metal Clip
- \*P = Plastic Clip
- \*A = Hinged Case

| PART NUMBER | Fig # on page 21 | *Available End Clip Types | DIMENSIONS mm (inches) |               |               |               |              | Typical Impedance (Z) in Ohms (Ω) |           |           |
|-------------|------------------|---------------------------|------------------------|---------------|---------------|---------------|--------------|-----------------------------------|-----------|-----------|
|             |                  |                           | A                      | B             | C*            | D             | E            | @ 25 MHz                          | @ 100 MHz | @ 300 MHz |
| 28S0670-000 | 2                | NA                        | 17.02 (0.670)          | 12.50 (0.492) | 14.99 (0.590) | 3.40 (0.134)  | 0.51 (0.020) | 60                                | 150       | 310       |
| 28S2001-0*0 | 1                | M, P                      | 63.50 (2.500)          | 52.07 (2.050) | 28.58 (1.125) | 6.35 (0.250)  | 0.84 (0.033) | 100                               | 280       | 590       |
| 28S2001-2A2 | 3                | Hinged Case               | 67.08 (2.641)          | 53.75 (2.116) | 27.53 (1.084) | 16.66 (0.656) | 1.91 (0.075) | 80                                | 230       | 480       |
| 28S2011-0*0 | 1                | M, P                      | 76.20 (3.000)          | 65.28 (2.570) | 28.58 (1.125) | 6.35 (0.250)  | 0.84 (0.033) | 100                               | 280       | 600       |
| 28S2012-0M0 | 1                | M                         | 88.90 (3.500)          | 78.23 (3.080) | 28.58 (1.125) | 6.48 (0.255)  | 0.84 (0.033) | 80                                | 240       | 630       |
| 28S2022-0*0 | 1                | M, P                      | 45.09 (1.775)          | 34.42 (1.355) | 28.58 (1.125) | 6.35 (0.250)  | 0.84 (0.033) | 100                               | 250       | 550       |
| 28S2023-0M0 | 1                | M                         | 38.10 (1.500)          | 26.67 (1.050) | 25.40 (1.000) | 6.35 (0.250)  | 0.84 (0.033) | 115                               | 250       | 520       |

Custom parts with double sided mounting tape and hinged case are available.

\*Broadband (28) ribbon and flex cable cores are sorted by slot width on pages 22 & 23 and sorted by impedance on pages 24 & 25.

\*\* The “D” & “E” dimensions for 28S, split, two piece cores must be doubled for total assembled dimensions. “D” & “E” dimensions shown for hinged case parts are for a complete assembly.

### PLASTIC CLIP DIAGRAM

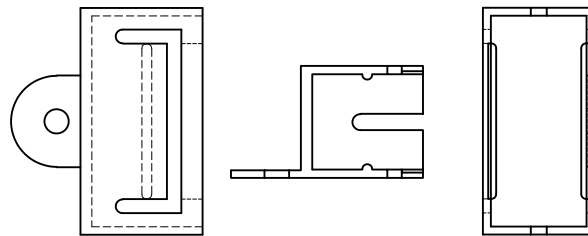

### METAL CLIP DIAGRAM

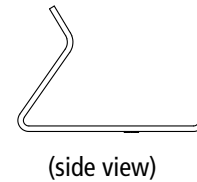

# SPLIT FERRITE CORES FOR RIBBON & FLEX CABLES

## PART #28S2001-2A2 SPLIT FERRITE CORE ASSEMBLY WITH HINGED BLACK PLASTIC CASE

\*\* To determine total inside slot gap (I.D.) of an assembled split ferrite ribbon core, multiply the "E" dimension by 2. Both the "D" and "E" dimensions must be doubled for assembled core dimensions.

FIGURE 1



FIGURE 2

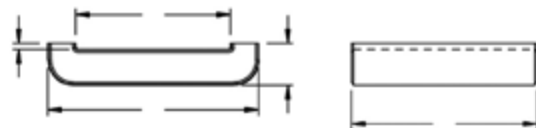
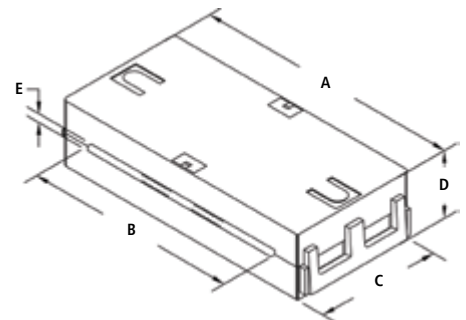
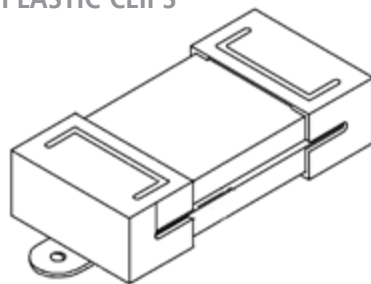

FIGURE 3



**SPLIT FERRITE CORES FOR FLAT / RIBBON CABLES ARE SOLD AS SINGLE SIDES. IT IS NECESSARY TO ORDER TWO SIDES TO FORM ONE SET. [EXCEPT 28S2001-2A2 (FIGURE 3) WHICH IS SOLD ASSEMBLED]**

### SPLIT CORE WITH WHITE PLASTIC CLIPS



### SPLIT CORE WITH METAL CLIPS

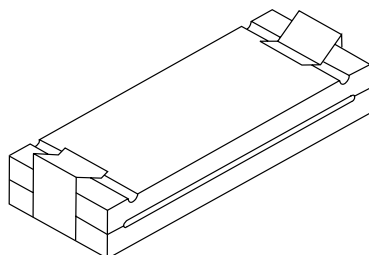

Plastic Clip Assemblies: To specify one core side and one white plastic clip together, replace the second ferrite core part number character after the dash with the letter "P" (example: 28S2022-0P0). One complete assembly of two ferrite core sides (28 material) with two plastic clips would be specified as follows: 2 of part # 28S2022-0P0. Attachment ears are standard.

Metal Clip Assemblies: To specify one core side and one metal clip together, replace the second ferrite core part number character after the dash with the letter "M" (example: 28S2022-0M0). One complete assembly of two ferrite cores (28 material) with two metal clips would be specified as follows: 2 of part # 28S2022-0M0.

Clips for Bulk Shipment: To order white plastic end clips (with attachment ears) separately in bulk, specify part number ASSE001-2. To order metal end clips separately in bulk, specify part number ASSE017-2. No standard clips are available for 28S2827-210.

# QUICK REFERENCE CHART SORTED BY SLOT WIDTH (B)

## BROADBAND 28 MATERIAL PARTS ONLY ONE-PIECE (28R) & SPLIT (28S) CORES FOR RIBBON & FLEX CABLES

| PART NUMBER<br>Sorted by<br>Slot Width | DIMENSIONS in mm |       |       |      |      |
|--|------------------|-------|-------|------|------|
|  | A                | B     | C     | D**  | E**  |
| 28R0315-200                            | 8.00             | 6.00  | 12.00 | 2.70 | 0.70 |
| 28R0394-000                            | 10.00            | 7.00  | 25.00 | 5.00 | 2.00 |
| 28R0453-200                            | 11.50            | 8.00  | 12.00 | 3.00 | 0.70 |
| 28R0480-000                            | 12.20            | 8.00  | 18.00 | 5.50 | 1.00 |
| 28R0480-100                            | 12.20            | 8.00  | 12.00 | 5.50 | 1.00 |
| 28R0453-300                            | 11.50            | 8.00  | 20.00 | 3.00 | 0.70 |
| 28R0492-100                            | 12.50            | 8.30  | 12.00 | 5.50 | 1.00 |
| 28S0670-000**                          | 17.02            | 12.50 | 14.99 | 3.40 | 0.51 |
| 28R0669-000                            | 17.00            | 13.00 | 12.00 | 3.50 | 0.75 |
| 28R0610-000                            | 15.50            | 13.50 | 10.00 | 3.40 | 1.40 |
| 28R0614-100                            | 15.60            | 13.60 | 12.00 | 2.80 | 0.70 |
| 28R0614-300                            | 15.60            | 13.60 | 18.00 | 2.80 | 0.70 |
| 28R0825-000                            | 20.95            | 14.00 | 19.05 | 7.75 | 0.80 |
| 28R0880-000                            | 22.35            | 14.00 | 19.05 | 7.75 | 1.50 |
| 28R0756-000                            | 19.20            | 15.00 | 10.00 | 5.35 | 1.15 |
| 28R0756-200                            | 19.20            | 15.00 | 16.00 | 5.35 | 1.15 |
| 28R0984-200                            | 25.00            | 18.00 | 16.00 | 7.70 | 0.90 |
| 28R0984-000                            | 25.00            | 18.00 | 24.00 | 7.70 | 0.90 |
| 28R0900-100                            | 22.80            | 18.70 | 12.00 | 3.60 | 0.70 |
| 28R0945-000                            | 24.00            | 19.00 | 10.00 | 6.25 | 1.25 |

\*\* The "D" & "E" dimensions for 28S split, two-piece cores must be doubled for total assembled dimensions.

Custom parts are also available.  
Refer to pages 16 - 20 for more data.

| PART NUMBER<br>Sorted by<br>Slot Width | DIMENSIONS in mm |       |       |       |      |
|--|------------------|-------|-------|-------|------|
|  | A                | B     | C     | D**   | E**  |
| 28R1024-000                            | 26.00            | 20.50 | 10.00 | 6.00  | 0.80 |
| 28R0983-000                            | 25.00            | 21.00 | 15.00 | 3.00  | 0.80 |
| 28R1025-000                            | 26.00            | 21.40 | 10.00 | 5.00  | 0.75 |
| 28R1101-000                            | 27.97            | 22.94 | 14.66 | 7.75  | 1.50 |
| 28R1102-000                            | 28.00            | 23.00 | 15.00 | 5.80  | 0.80 |
| 28R1236-000                            | 31.40            | 23.00 | 19.00 | 7.75  | 1.50 |
| 28R1102-100                            | 28.00            | 23.00 | 20.00 | 5.80  | 0.80 |
| 28R1103-000                            | 28.00            | 23.00 | 27.00 | 6.10  | 1.10 |
| 28R1127-500                            | 28.58            | 23.50 | 9.70  | 7.70  | 1.70 |
| 28R1127-400                            | 28.58            | 23.50 | 17.00 | 7.70  | 1.70 |
| 28R1127-200                            | 28.58            | 23.50 | 24.89 | 7.70  | 1.70 |
| 28R1127-000                            | 28.58            | 23.50 | 31.00 | 7.70  | 1.70 |
| 28R1128-100                            | 28.58            | 24.00 | 26.00 | 5.38  | 0.80 |
| 28R1128-200                            | 28.58            | 24.00 | 14.00 | 5.38  | 0.80 |
| 28R1227-100                            | 31.12            | 24.77 | 13.30 | 8.26  | 1.91 |
| 28R1261-200                            | 32.00            | 25.10 | 9.70  | 7.75  | 0.90 |
| 28R1261-100                            | 32.00            | 25.10 | 35.00 | 7.75  | 0.90 |
| 28R1262-000                            | 32.00            | 26.00 | 30.00 | 7.00  | 1.00 |
| 28R1417-000                            | 36.00            | 26.00 | 40.00 | 11.00 | 1.00 |
| 28R1517-000                            | 38.10            | 26.67 | 25.40 | 12.07 | 1.91 |
| 28S2023-0M0**                          | 38.10            | 26.67 | 25.40 | 6.35  | 0.84 |
| 28R1518-000                            | 38.50            | 26.80 | 25.40 | 12.09 | 1.91 |
| 28R1319-000                            | 33.50            | 27.00 | 12.00 | 6.50  | 1.50 |
| 28R1340-100                            | 34.00            | 28.00 | 12.00 | 7.00  | 1.00 |
| 28R1340-200                            | 34.00            | 28.00 | 25.00 | 7.00  | 1.00 |
| 28R1300-000                            | 33.02            | 28.50 | 3.00  | 5.00  | 0.59 |
| 28R1450-100                            | 36.83            | 29.58 | 10.00 | 7.75  | 0.75 |



# QUICK REFERENCE CHART SORTED BY SLOT WIDTH (B)

## BROADBAND 28 MATERIAL PARTS ONLY ONE-PIECE (28R) & SPLIT (28S) CORES FOR RIBBON & FLEX CABLES

| PART NUMBER<br>Sorted by<br>Slot Width | DIMENSIONS in mm |       |       |       |      |
|--|------------------|-------|-------|-------|------|
|  | A                | B     | C     | D**   | E**  |
| 28R1496-000                            | 38.00            | 30.00 | 25.00 | 9.25  | 1.25 |
| 28R1418-000                            | 36.00            | 33.00 | 10.00 | 4.00  | 1.00 |
| 28R1457-400                            | 37.01            | 33.00 | 13.46 | 4.50  | 0.51 |
| 28R1775-000                            | 45.08            | 34.42 | 28.58 | 12.45 | 1.52 |
| 28S2022-0*0**                          | 45.09            | 34.42 | 28.58 | 6.35  | 0.84 |
| 28R1476-100                            | 37.50            | 34.50 | 13.00 | 4.00  | 1.00 |
| 28R1862-000                            | 47.70            | 39.00 | 31.00 | 15.00 | 3.00 |
| 28R2000-200                            | 50.80            | 40.60 | 28.00 | 12.20 | 2.00 |
| 28R2170-100                            | 55.12            | 43.69 | 12.70 | 12.70 | 1.27 |
| 28R2170-000                            | 55.12            | 43.69 | 25.40 | 12.70 | 1.27 |
| 28R1953-000                            | 49.61            | 44.00 | 12.00 | 7.62  | 1.45 |
| 28R1779-100                            | 63.50            | 52.07 | 12.98 | 12.70 | 1.68 |
| 28R1779-000                            | 63.50            | 52.07 | 28.58 | 12.70 | 1.68 |
| 28S2001-0*0**                          | 63.50            | 52.07 | 28.58 | 6.35  | 0.84 |
| 28S2001-2A2**                          | 63.50            | 52.07 | 24.38 | 6.35  | 0.84 |
| 28S2011-0*0**                          | 76.20            | 65.28 | 28.58 | 6.35  | 0.84 |
| 28R3149-000                            | 79.98            | 68.58 | 12.70 | 11.99 | 1.91 |
| 28S2012-0M0**                          | 88.90            | 78.23 | 28.58 | 6.48  | 0.84 |

\*\* The "D" & "E" dimensions for 28S split, two-piece cores must be doubled for total assembled dimensions.

Custom parts are also available  
Refer to pages 16 - 20 for more data.

# QUICK REFERENCE CHART SORTED BY IMPEDANCE @ 100 MHZ

## BROADBAND 28 MATERIAL PARTS ONLY ONE-PIECE (28R) & SPLIT (28S) CORES FOR RIBBON & FLEX CABLES

| PART NUMBER<br>Sorted by<br>Impedance | Typical Impedance (Z)<br>in Ohms ( $\Omega$ ) |           |           |
|---------------------------------------|---|-----------|-----------|
|                                       | @ 25 MHz                                      | @ 100 MHz | @ 300 MHz |
| 28R1300-000                           | 21  | 72        | 200       |
| 28R0610-000                           | 29  | 80        | 216       |
| 28R0386-000                           | 36  | 96        | 224       |
| 28R1025-000                           | 34  | 97        | 242       |
| 28R0614-100                           | 36  | 98        | 245       |
| 28R0315-200                           | 48  | 102       | 250       |
| 28R1418-000                           | 34  | 104       | 245       |
| 28R0453-200                           | 43  | 104       | 260       |
| 28R0756-000                           | 40  | 107       | 258       |
| 28R1127-500                           | 40  | 110       | 265       |
| 28R1476-100                           | 38  | 110       | 251       |
| 28R0669-000                           | 41  | 110       | 270       |
| 28R0945-000                           | 43  | 112       | 269       |
| 28R1319-000                           | 43  | 117       | 269       |
| 28R0983-000                           | 43  | 123       | 276       |
| 28R0614-300                           | 45  | 125       | 280       |
| 28R1953-000                           | 45  | 127       | 300       |
| 28R1024-000                           | 48  | 128       | 299       |
| 28R1227-100                           | 52  | 128       | 300       |
| 28R1450-100                           | 48  | 130       | 290       |
| 28R1261-200                           | 50  | 135       | 310       |
| 28R3149-000                           | 51  | 135       | 318       |
| 28R1340-100                           | 50  | 139       | 315       |

| PART NUMBER<br>Sorted by<br>Impedance | Typical Impedance (Z)<br>in Ohms ( $\Omega$ ) |           |           |
|---------------------------------------|---|-----------|-----------|
|                                       | @ 25 MHz                                      | @ 100 MHz | @ 300 MHz |
| 28R1101-000                           | 55  | 140       | 300       |
| 28R0756-200                           | 57  | 140       | 308       |
| 28R1457-400                           | 44  | 140       | 310       |
| 28R1128-200                           | 52  | 145       | 312       |
| 28R0480-100                           | 68  | 150       | 290       |
| 28R0492-100                           | 68  | 150       | 290       |
| 28S0670-000                           | 60  | 150       | 310       |
| 28R1127-400                           | 60  | 150       | 330       |
| 28R1102-000                           | 61  | 154       | 340       |
| 28R0453-300                           | 72  | 160       | 330       |
| 28R1236-000                           | 78  | 162       | 370       |
| 28R0394-000                           | 92  | 169       | 294       |
| 28R2170-100                           | 62  | 170       | 370       |
| 28R0984-200                           | 70  | 170       | 370       |
| 28R1779-100                           | 65  | 170       | 375       |
| 28R0880-000                           | 93  | 187       | 356       |
| 28R0480-000                           | 100   | 190       | 320       |
| 28R0825-000                           | 96  | 190       | 363       |
| 28R1127-200                           | 85  | 191       | 410       |
| 28R1102-100                           | 75  | 192       | 380       |
| 28R1128-100                           | 79  | 204       | 399       |
| 28R0900-100                           | 38  | 116       | 266       |

All chart data can be sorted on [lairdtech.com](http://lairdtech.com)  
Refer to pages 16 - 20 for more data.

QUICK REFERENCE CHART  
SORTED BY IMPEDANCE @ 100 MHZ

**BROADBAND 28 MATERIAL PARTS ONLY**  
**ONE-PIECE (28R) & SPLIT (28S) CORES FOR RIBBON & FLEX CABLES**

| PART NUMBER<br>Sorted by<br>Impedance | Typical Impedance (Z)<br>in Ohms (Ω) |              |              |
|---------------------------------------|--------------------------------------|--------------|--------------|
|                                       | @ 25 MHz                             | @ 100<br>MHz | @ 300<br>MHz |
| 28R0984-000                           | 100                                  | 220          | 430          |
| 28R1127-000                           | 100                                  | 220          | 430          |
| 28R1340-200                           | 86                                   | 220          | 449          |
| 28S2001-2A2                           | 80                                   | 230          | 480          |
| 28R1103-000                           | 95                                   | 230          | 480          |
| 28R1517-000                           | 110                                  | 230          | 520          |
| 28R1518-000                           | 105                                  | 235          | 478          |
| 28R1496-000                           | 91                                   | 239          | 479          |
| 28S2012-0M0                           | 80                                   | 240          | 630          |
| 28S2023-0M0                           | 115                                  | 250          | 520          |
| 28S2022-0*0                           | 100                                  | 250          | 550          |
| 28R2000-200                           | 103                                  | 252          | 545          |
| 28R1262-000                           | 110                                  | 260          | 520          |
| 28R1775-000                           | 115                                  | 260          | 530          |
| 28R1862-000                           | 116                                  | 261          | 561          |
| 28R2170-000                           | 110                                  | 280          | 550          |
| 28S2001-0*0                           | 100                                  | 280          | 590          |
| 28S2011-0*0                           | 100                                  | 280          | 600          |
| 28R1779-000                           | 114                                  | 298          | 588          |
| 28R1261-100                           | 140                                  | 350          | 700          |
| 28R1417-000                           | 187                                  | 393          | 734          |

All chart data can be sorted on [lairdtech.com](http://lairdtech.com)  
Refer to pages 16 - 20 for more data.

# FERRITE EMI DISKS AND PLATES



Ferrite disks and plates provide a simple, cost-effective solution for radiated and inductively-coupled electromagnetic interference. After the PC board soldering process, a ferrite disk or plate can be installed directly on the source of EMI (such as active devices or unwanted antennas).

### FEATURES:

- Easy installation
- Each part for volume production is provided with permanent, double sided 3,5 mil acrylic adhesive with 218 oz. / inch<sup>2</sup> adhesion
- Samples and sample kits are available with removable and reusable adhesive for "trial and error" testing
- Variety of sizes offered
- Custom parts also available.

### APPLICATIONS:

- Ferrite disks and plates can be utilized either as inductively coupled components or EMI shields on PC board components and traces. Inductive coupling occurs when the ferrite affects the conducted wave form leaving the active component. The rise time of the wave form is effectively slowed by the ferrite, and the overshoot and associated ringing are attenuated. EMI shielding occurs when the ferrite absorbs the radiated emissions from active components, effectively protecting other boards or components in the vicinity from radiated contamination
- Can be used to locate unwanted EMI antennas
- Flat flex & ribbon cables
- Can also provide retrofit, auxiliary EMI attenuation

### EXAMPLE APPLICATION

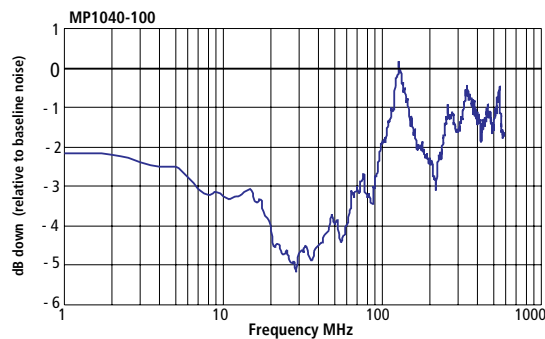

### EXAMPLE APPLICATION GRAPH EXPLANATION:

The zero line on the graph represents the base line noise recorded for an unprotected microprocessor. The curve (dB down) represent the performance of the Laird's ferrite plate relative to the baseline. The addition of the ferrite plates to the top of the processor in this specific application exhibits up to a 5 dB EMI reduction relative to the unprotected part. Performance can vary with different sizes, materials, processors and applications.

### PART NUMBER SYSTEM EXAMPLE

|              |                       |                             |                   |
|--------------|-----------------------|-----------------------------|-------------------|
| <b>M</b>     | <b>M</b>              | <b>0787</b>                 | <b>100</b>        |
| M - Material | M - Disk<br>P - Plate | Part Size<br>Identification | Thickness<br>Code |

| PART NUMBER | A mm (inches) | B mm (inches) | C mm (inches) |
|-------------|---------------|---------------|---------------|
| MM0650-100  | 16.51 (0.650) | —             | 1.27 (0.050)  |
| MM0787-100  | 20.00 (0.787) | —             | 1.27 (0.050)  |
| MM0787-200  | 20.00 (0.787) | —             | 1.91 (0.075)  |
| MM1400-200  | 35.56 (1.400) | —             | 1.91 (0.075)  |
| MM1400-300  | 35.56 (1.400) | —             | 2.54 (0.100)  |
| MP0315-200  | 8.00 (0.315)  | 8.00 (0.315)  | 2.00 (0.079)  |
| MP0350-000  | 26.42 (1.040) | 8.89 (0.350)  | 1.27 (0.050)  |
| MP0433-000  | 11.00 (0.433) | 11.00 (0.433) | 1.96 (0.077)  |
| MP0512-200  | 13.00 (0.512) | 13.00 (0.512) | 2.00 (0.079)  |
| MP0590-200  | 21.00 (0.827) | 15.00 (0.591) | 2.00 (0.079)  |
| MP0591-200  | 15.00 (0.591) | 15.00 (0.591) | 2.00 (0.079)  |
| MP0760-100  | 19.30 (0.760) | 19.30 (0.760) | 1.27 (0.050)  |
| MP1040-100  | 26.42 (1.040) | 26.42 (1.040) | 1.27 (0.050)  |
| MP1040-200  | 26.42 (1.040) | 26.42 (1.040) | 1.91 (0.075)  |
| MP1040-300  | 26.42 (1.040) | 26.42 (1.040) | 2.25 (0.089)  |
| MP1496-000  | 38.00 (1.496) | 38.00 (1.496) | 2.00 (0.079)  |

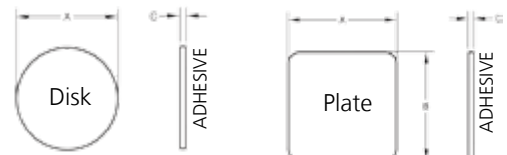

# MP & 33 SERIES



## FEATURES



- Ferrite materials are Wireless Power Consortium (WPC) listed, recommended & certified for interoperability test
- Optimized for highest charging efficiency
- Precise dimension control and automotive grade available
- -40°C to 125°C operating temperature
- Available in wide range of size selection, custom shapes are also available

## APPLICATIONS

- Wireless charger for general consumer electronics, transmitter (TX) or receiver (RX)
- Aftermarket charging pads
- Wireless charger for Office, Residential and Public Area applications
- Wireless charger embedded solution for automobile central console, arm-rest, etc.
- Power tools or any industrial devices that need power transmission without metallic contact

## DIMENSIONS

| PART NUMBER | A mm (inches)  | B mm (inches) | C mm (inches) | Fig. # |
|-------------|----------------|---------------|---------------|--------|
| MP1040-3M0  | 26.42 (1.040)  | 26.42 (1.040) | 2.25 (0.089)  | 1      |
| MP1496-0M0  | 38.00 (1.496)  | 38.00 (1.496) | 2.00 (0.079)  | 1      |
| MP2106-0M0  | 53.00 (2.087)  | 53.00 (2.087) | 2.50 (0.099)  | 1      |
| MP2126-0M0  | 53.80 (2.118)  | 53.80 (2.118) | 1.10 (0.043)  | 1      |
| MP2170-1M0  | 47.20 (1.858)  | 55.20 (2.173) | 2.50 (0.099)  | 1      |
| MP3940-0M0  | 100.00 (3.937) | 56.00 (2.205) | 1.10 (0.043)  | 1      |
| 33P2098-0M0 | 53.30 (2.099)  | 53.30 (2.099) | 2.50 (0.099)  | 1      |
| 33P3839-0M0 | 97.50 (3.839)  | 50.00 (1.969) | 1.10 (0.043)  | 2      |

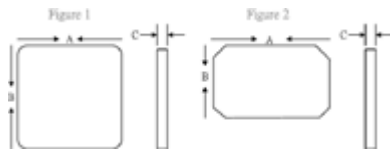

## PART NUMBER SYSTEM EXAMPLE

|                                 |       |                |   |
|---------------------------------|-------|----------------|---|
| 33                              | P     | 2098           | 0M0   |
| M-28 Material<br>33-33 Material | Plate | Part Size Code | Thickness Code<br>Catalog or Custom Information |

**MATERIAL SPECIFICATIONS**

| PROPERTY                | SYMBOL                   | UNIT             | 28 Material<br>(WPC Listed) | 33 Material         |
|-------------------------|--------------------------|------------------|-----------------------------|---------------------|
| Initial Permeability    | $\mu_i$                  |                  | 650                         | 2300                |
| Flux Density            | $B$                      | mT [Gauss]       | 280 [2800]                  | 390 [3900]          |
| @ Field Strength        | $H$                      | A/m [Oe]         | 800 [10]                    | 800 [10]            |
| Residual Field Strength | $B_r$                    | mT [Gauss]       | 130 [1300]                  | 55 [550]            |
| Coercive Strength       | $H_c$                    | A/m [Oe]         | 32 [0.4]                    | 9 [0.1]             |
| Loss Factor @ Frequency | $\tan \delta/\mu_i$<br>f | 10 <sup>-6</sup> | 500                         | 6                   |
|                         |                          | MHz              | 0.1                         | 0.1                 |
| Curie Temperature       | $T_c$                    | °C               | > 140                       | > 200               |
| Resistivity             | $\rho$                   | $\Omega$ -cm     | 10 <sup>5</sup>             | 5 x 10 <sup>2</sup> |

**TYPICAL ELECTRICAL CHARACTERISTICS**

**28 MATERIAL**

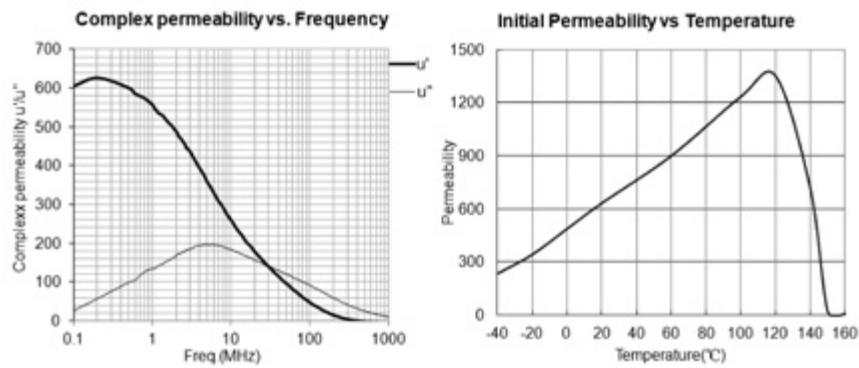

**33 MATERIAL**

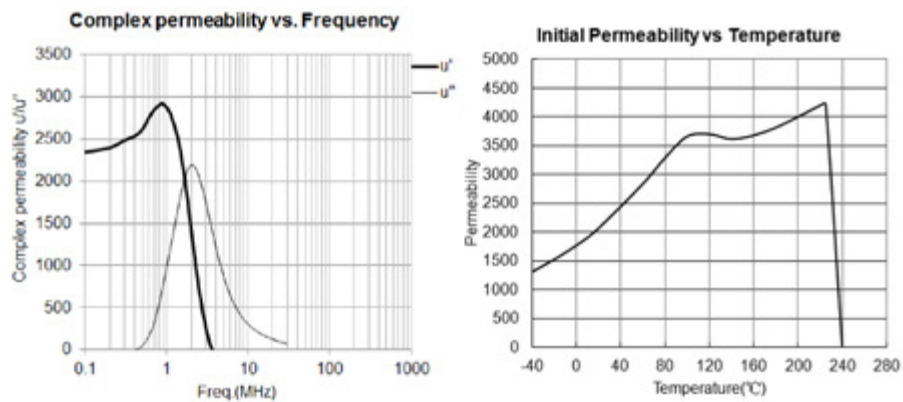

# MHLL SERIES



## FEATURES



- Flexible ferrite sheets for 13.56 MHz NFC, RFID application & wireless charging application
- Made by thin, high permeability sintered ferrite with PET film and adhesive tape
- Standard ferrite layer thickness 0.05mm, 0.1mm and 0.2mm
- Custom size or thickness available upon request
- Operating temperature -40°C to 85°C
- RoHS compliant

## APPLICATIONS

- NFC antenna for mobile phones
- NFC antenna for automobile
- NFC or RFID antenna for security & access control system
- Wireless charging for mobile phones and battery powered handheld electronic devices
- NFC or RFID read/write devices, improved read distance
- EMI suppression for IC or IC circuitry

## SHAPES AND DIMENSIONS

| PART NUMBER   | A mm (inches) | B mm (inches) | C mm (inches) | D mm (inches) |
|---------------|---------------|---------------|---------------|---------------|
| MHLL5040-000  | 50 (1.969)    | 40 (1.575)    | 0.20 (0.008)  | 0.35 (0.014)  |
| MHLL5040-200  | 50 (1.969)    | 40 (1.575)    | 0.10 (0.004)  | 0.20 (0.008)  |
| MHLL6060-300  | 60 (2.362)    | 60 (2.362)    | 0.05 (0.002)  | 0.09 (0.004)  |
| MHLL12060-000 | 120 (4.724)   | 60 (2.362)    | 0.20 (0.008)  | 0.35 (0.014)  |
| MHLL12060-200 | 120 (4.724)   | 60 (2.362)    | 0.10 (0.004)  | 0.20 (0.008)  |

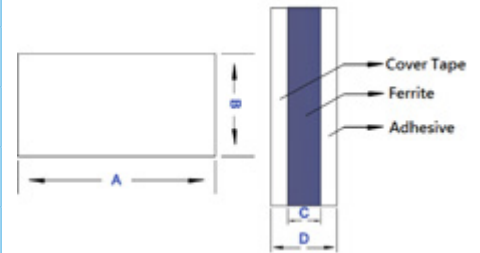

## PART NUMBER SYSTEM EXAMPLE

| MHLL          | 12060          | 000   |
|---------------|----------------|---|
| Material Code | Part Size Code | Thickness Code<br>Catalog or Custom Information |

## MATERIAL SPECIFICATIONS

| PROPERTY               | MHLL Series              |               |
|------------------------|--------------------------|---------------|
| Real Permeability      | $\mu'$ @ 13.56MHz, 0.1V  | 130 ± 20%     |
| Imaginary Permeability | $\mu''$ @ 13.56MHz, 0.1V | 5 max         |
| Operating Temperature  | °C                       | -40°C ~ +85°C |

## TYPICAL ELECTRICAL CHARACTERISTICS

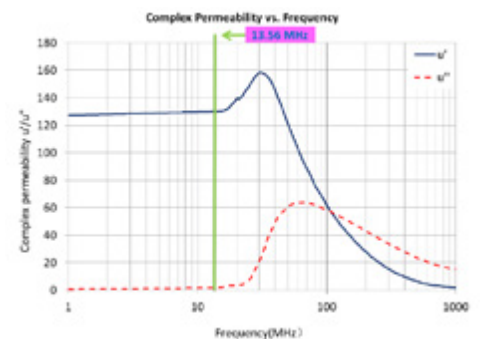

# MSLL SERIES



## FEATURES



- Flexible ferrite sheets for 13.56 MHz NFC, RFID application & wireless charging application
- Made by thin, high permeability sintered ferrite with PET film and adhesive tape
- Standard ferrite layer thickness 0.05mm, 0.1mm and 0.2mm
- Custom size or thickness available upon request
- Operating temperature -40°C to 85°C
- RoHS compliant

## APPLICATIONS

- NFC antenna for mobile phones
- NFC antenna for automobile
- NFC or RFID antenna for security & access control system
- Wireless charging for mobile phones and battery powered handheld electronic devices
- NFC or RFID read/write devices, improved read distance
- EMI suppression for IC or IC circuitry

## SHAPES AND DIMENSIONS

| PART NUMBER   | A mm (inches) | B mm (inches) | C mm (inches) | D mm (inches) |
|---------------|---------------|---------------|---------------|---------------|
| MSLL5040-000  | 50 (1.969)    | 40 (1.575)    | 0.20 (0.008)  | 0.35 (0.014)  |
| MSLL5040-200  | 50 (1.969)    | 40 (1.575)    | 0.10 (0.004)  | 0.20 (0.008)  |
| MSLL6060-300  | 60 (2.362)    | 60 (2.362)    | 0.05 (0.002)  | 0.09 (0.004)  |
| MSLL12060-000 | 120 (4.724)   | 60 (2.362)    | 0.20 (0.008)  | 0.35 (0.014)  |
| MSLL12060-200 | 120 (4.724)   | 60 (2.362)    | 0.10 (0.004)  | 0.20 (0.008)  |

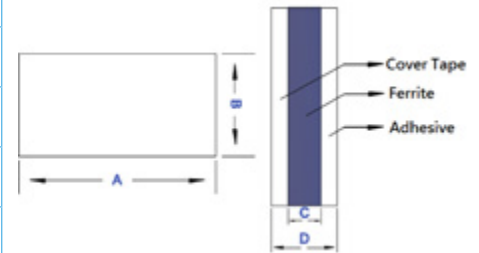

## PART NUMBER SYSTEM EXAMPLE

| MSLL          | 12060          | 000   |
|---------------|----------------|---|
| Material Code | Part Size Code | Thickness Code<br>Catalog or Custom Information |

## MATERIAL SPECIFICATIONS

| PROPERTY               |                          | MSLL Series   |
|------------------------|--------------------------|---------------|
| Real Permeability      | $\mu'$ @ 13.56MHz, 0.1V  | 100 ± 20%     |
| Imaginary Permeability | $\mu''$ @ 13.56MHz, 0.1V | 5 max         |
| Operating Temperature  | °C                       | -40°C ~ +85°C |

## TYPICAL ELECTRICAL CHARACTERISTICS

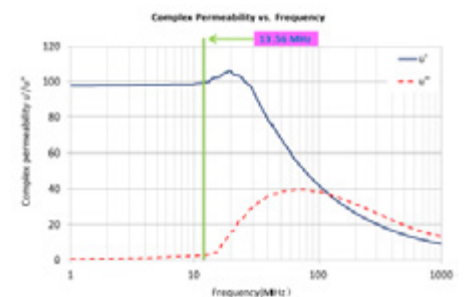



# MULL SERIES



## FEATURES



- Flexible ferrite sheets for 13.56 MHz NFC, RFID application & wireless charging application
- Made by thin, high permeability sintered ferrite with PET film and adhesive tape
- Standard ferrite layer thickness 0.05mm, 0.1 mm and 0.2mm
- Custom size or thickness available upon request
- Operating temperature -40°C to 85°C
- RoHS compliant

## APPLICATIONS

- NFC antenna for mobile phones
- NFC antenna for automobile
- NFC or RFID antenna for security & access control system
- Wireless charging for mobile phones and battery powered handheld electronic devices
- NFC or RFID read/write devices, improved read distance
- EMI suppression for IC or IC circuitry

## SHAPES AND DIMENSIONS

| PART NUMBER   | A mm (inches) | B mm (inches) | C mm (inches) | D mm (inches) |
|---------------|---------------|---------------|---------------|---------------|
| MULL5040-000  | 50 (1.969)    | 40 (1.575)    | 0.20 (0.008)  | 0.35 (0.014)  |
| MULL5040-200  | 50 (1.969)    | 40 (1.575)    | 0.10 (0.004)  | 0.20 (0.008)  |
| MULL6060-300  | 60 (2.362)    | 60 (2.362)    | 0.05 (0.002)  | 0.09 (0.004)  |
| MULL12060-000 | 120 (4.724)   | 60 (2.362)    | 0.20 (0.008)  | 0.35 (0.014)  |
| MULL12060-200 | 120 (4.724)   | 60 (2.362)    | 0.10 (0.004)  | 0.20 (0.008)  |

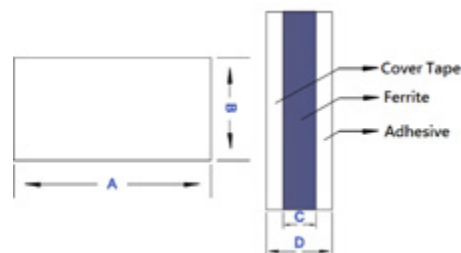

## PART NUMBER SYSTEM EXAMPLE

| MULL          | 12060          | 000   |
|---------------|----------------|---|
| Material Code | Part Size Code | Thickness Code<br>Catalog or Custom Information |

## MATERIAL SPECIFICATIONS

| PROPERTY               |                          | MULL Series   |
|------------------------|--------------------------|---------------|
| Real Permeability      | $\mu'$ @ 13.56MHz, 0.1V  | 150 ± 20%     |
| Imaginary Permeability | $\mu''$ @ 13.56MHz, 0.1V | 5 max         |
| Operating Temperature  | °C                       | -40°C ~ +85°C |

## TYPICAL ELECTRICAL CHARACTERISTICS

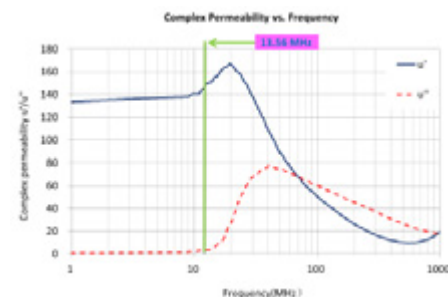

FERRITE EMI CABLE CORES

SAMPLE KIT LISTS

BROADBAND EMI FERRITE CYLINDRICAL EMI CORES, SPLIT/SNAP-ON CORES

PARTS AND SUPPLIES FOR SAMPLE KIT# K-401 EMI B

| PART NUMBER | QTY PER KIT | PART NUMBER | QTY PER KIT |
|-------------|-------------|-------------|-------------|
| 28A0640-0A0 | 1           | 28B0590-000 | 4           |
| 28A2024-0A0 | 1           | 28B0591-200 | 4           |
| 28A2025-0A0 | 1           | 28B0625-000 | 4           |
| 28A2029-0A0 | 1           | 28B0625-100 | 4           |
| 28B1122-100 | 1           | 28B0631-100 | 4           |
| 28B1250-000 | 1           | 28B0672-000 | 4           |
| 28B1531-000 | 1           | 28B0686-100 | 4           |
| 28A0593-0A2 | 2           | 28B0686-200 | 4           |
| 28B0616-000 | 2           | 28B0734-000 | 4           |
| 28B0870-100 | 2           | 28B0735-000 | 4           |
| 28B0999-000 | 2           | 28B0735-300 | 4           |
| 28B1020-100 | 2           | 28B0773-050 | 4           |
| 28B1142-100 | 2           | 28B0825-000 | 4           |
| 28B1417-200 | 2           | 28B0870-000 | 4           |
| 28B1225-100 | 3           | 28B1000-000 | 4           |
| 28B0500-300 | 4           | 28B0570-000 | 8           |
| 28B0562-100 | 4           | 28B0686-000 | 8           |
| 28B0562-200 | 4           | 28B0500-100 | 12          |
| 28B0563-100 | 4           |             |             |

PARTS AND SUPPLIES FOR SAMPLE KIT# K-402 EMI B SML

| PART NUMBER | QTY PER KIT | PART NUMBER | QTY PER KIT |
|-------------|-------------|-------------|-------------|
| 28A0350-0B2 | 2           | 28B0375-100 | 4           |
| 28A0392-0A2 | 2           | 28B0375-300 | 4           |
| 28A0434-0A2 | 1           | 28B0375-400 | 8           |
| 28B0250-100 | 6           | 28B0384-000 | 4           |
| 28B0268-000 | 6           | 28B0384-200 | 4           |
| 28B0275-000 | 6           | 28B0390-200 | 4           |
| 28B0296-000 | 6           | 28B0434-000 | 2           |
| 28B0315-000 | 6           | 28B0472-090 | 4           |
| 28B0315-100 | 6           | 28B0473-000 | 8           |
| 28B0339-000 | 8           | 28B0473-200 | 4           |
| 28B0355-000 | 4           | 28B0485-000 | 4           |
| 28B0375-000 | 4           | 28B0562-000 | 4           |

FERRITE EMI CABLE CORES

SAMPLE KIT LISTS

BROADBAND EMI FERRITE SPLIT/SNAP-ON CORES

PARTS AND SUPPLIES FOR SAMPLE KIT# K-403 EMI A DEMO

| PART NUMBER | QTY PER KIT |
|-------------|-------------|
| 28A0350-0B2 | 1           |
| 28A0392-0A2 | 1           |
| 28A0434-0A2 | 1           |
| 28A0592-0A2 | 1           |
| 28A0593-0A2 | 1           |
| 28A0640-0A2 | 1           |
| 28A2024-0A2 | 1           |
| 28A2025-0A2 | 1           |
| 28A2026-0A2 | 1           |
| 28A2029-0A2 | 1           |
| 28A2432-0A2 | 1           |
| 28A2736-0A2 | 1           |
| 28A3851-0A2 | 1           |
| 28A5776-0A2 | 1           |

PARTS AND SUPPLIES FOR SAMPLE KIT# K-404 EMI A

| PART NUMBER | QTY PER KIT |
|-------------|-------------|
| 28A0350-0B2 | 12          |
| 28A0392-0A2 | 12          |
| 28A0434-0A2 | 6           |
| 28A0592-0A2 | 6           |
| 28A0593-0A2 | 6           |
| 28A0807-0A2 | 4           |
| 28A2024-0A2 | 2           |
| 28A2025-0A2 | 4           |
| 28A2026-0A2 | 3           |
| 28A2029-0A2 | 4           |
| 28A2432-0A2 | 4           |
| 28A2736-0A2 | 4           |
| 28A3039-0A2 | 3           |
| 28A3851-0A2 | 2           |
| 28A4155-0A2 | 3           |
| 28A5776-0A2 | 1           |

FERRITE EMI CABLE CORES  
SAMPLE KIT LISTS

ONE-PIECE(28R) & SPLIT (28S)  
CORES FOR RIBBON & FLEX CABLES

**PARTS AND SUPPLIES FOR  
SAMPLE KIT# K-406 EMI R**

| PART NUMBER | QTY PER KIT |
|-------------|-------------|
| 28R0315-200 | 22          |
| 28R0453-200 | 18          |
| 28R0453-300 | 9           |
| 28R0480-000 | 6           |
| 28R0592-010 | 5           |
| 28R0610-000 | 20          |
| 28R0614-100 | 24          |
| 28R0669-000 | 18          |
| 28R0756-000 | 12          |
| 28R0756-200 | 12          |
| 28R0880-000 | 4           |
| 28R0898-100 | 20          |
| 28R0898-200 | 20          |
| 28R0945-000 | 10          |
| 28R0984-000 | 4           |
| 28R0984-200 | 8           |
| 28R1024-000 | 10          |
| 28R1102-000 | 10          |
| 28R1102-100 | 5           |
| 28R1127-200 | 4           |
| 28R1127-500 | 12          |
| 28R1141-010 | 3           |
| 28R1227-100 | 8           |
| 28R1236-000 | 4           |
| 28R1240-010 | 4           |
| 28R1261-100 | 4           |
| 28R1261-200 | 12          |
| 28R1262-000 | 4           |
| 28R1340-100 | 10          |
| 28R1340-200 | 4           |
| 28R1417-000 | 3           |
| 28R1450-100 | 12          |
| 28R1457-400 | 6           |
| 28R1496-000 | 3           |
| 28R1517-000 | 3           |
| 28R1654-010 | 8           |
| 28S0670-000 | 20          |
| 28S2023-0M0 | 4           |
| 28S2827-210 | 16          |

HIGH FREQUENCY FERRITE  
CYLINDRICAL, SPLIT, SNAP-ON CORES

**PARTS AND SUPPLIES FOR  
SAMPLE KIT# K-409 EMI HFB**

| PART NUMBER   | QTY PER KIT |
|---------------|-------------|
| HFA100049-0A2 | 6           |
| HFA150066-0A2 | 4           |
| HFA150068-0A2 | 4           |
| HFA163090-0A2 | 4           |
| HFA187102-0A2 | 4           |
| HFA259131-0A2 | 3           |
| HFB075024-000 | 12          |
| HFB095051-100 | 9           |
| HFB095051-200 | 12          |
| HFB123049-000 | 10          |
| HFB123049-100 | 12          |
| HFB123049-300 | 6           |
| HFB143064-000 | 8           |
| HFB143064-100 | 8           |
| HFB143064-300 | 6           |
| HFB150070-200 | 6           |
| HFB152034-000 | 12          |
| HFB157070-000 | 4           |
| HFB159079-100 | 6           |
| HFB160093-200 | 4           |
| HFB160093-300 | 6           |
| HFB170070-000 | 8           |
| HFB170070-100 | 6           |
| HFB187102-100 | 6           |
| HFB259128-100 | 3           |

SAMPLE KIT LISTS

LOW FREQUENCY FERRITE EMI CORES

PARTS AND SUPPLIES FOR SAMPLE KIT# K-408 EMI LFB

| PART NUMBER   | QTY PER KIT |
|---------------|-------------|
| LFB090050-000 | 24          |
| LFB095051-000 | 12          |
| LFB127079-000 | 24          |
| LFB143064-000 | 6           |
| LFB143064-100 | 12          |
| LFB159079-000 | 6           |
| LFB174095-000 | 6           |
| LFB180100-000 | 18          |
| LFB187102-000 | 6           |
| LFB220140-000 | 8           |
| LFB250150-000 | 8           |
| LFB259128-000 | 4           |
| LFB290190-000 | 6           |
| LFB310190-000 | 6           |
| LFB360230-300 | 4           |

FERRITE EMI DISKS AND PLATES

FERRITE PLATES FOR WIRELESS CHARGING

PARTS AND SUPPLIES FOR SAMPLE KIT# K-407 EMI DISC PL

| PART NUMBER | QTY PER KIT |
|-------------|-------------|
| MM0650-100  | 5           |
| MM0787-100  | 5           |
| MM0787-200  | 5           |
| MM1400-200  | 5           |
| MM1400-300  | 5           |
| MP0315-200  | 5           |
| MP0350-000  | 5           |
| MP0433-000  | 5           |
| MP0512-200  | 5           |
| MP0590-200  | 5           |
| MP0591-200  | 5           |
| MP0760-100  | 5           |
| MP1040-100  | 5           |
| MP1040-200  | 5           |
| MP1040-300  | 5           |
| MP1496-000  | 5           |

PARTS AND SUPPLIES FOR SAMPLE KIT# K-412 PLATES

| PART NUMBER | QTY PER KIT |
|-------------|-------------|
| MP1040-3M0  | 4           |
| MP1496-0M0  | 4           |
| MP2106-0M0  | 3           |
| MP2126-0M0  | 3           |
| MP2170-1M0  | 3           |
| MP3940-0M0  | 1           |
| 33P2098-0M0 | 2           |
| 33P3839-0M0 | 2           |

