

CATALOG NO.	TERMINAL TYPE	IP20 FINGER SAFE C		NO. OF POLES
		W/O INDICATION	INDICATION	
RM60030-1SR	SCREW	CVR-RH-60030	CVRI-RH-60030	1
RM60030-2SR	SCREW			2
RM60030-3SR	SCREW			3
RM60030-1PR	PRESSURE PLATE			1
RM60030-2PR	PRESSURE PLATE			2
RM60030-3PR	PRESSURE PLATE			3
RM60030-1CR*	BOX LUG	NA	NA	1
RM60030-2CR*	BOX LUG			2
RM60030-3CR*	BOX LUG			3
RM60030-1MW14	BOX LUG - 4 PORT MULTIWIRE	NA	NA	1
RM60030-2MW14	BOX LUG - 4 PORT MULTIWIRE			2
RM60030-3MW14	BOX LUG - 4 PORT MULTIWIRE			3

*-CHR ALSO AVAILABLE; SEE NOTE 11

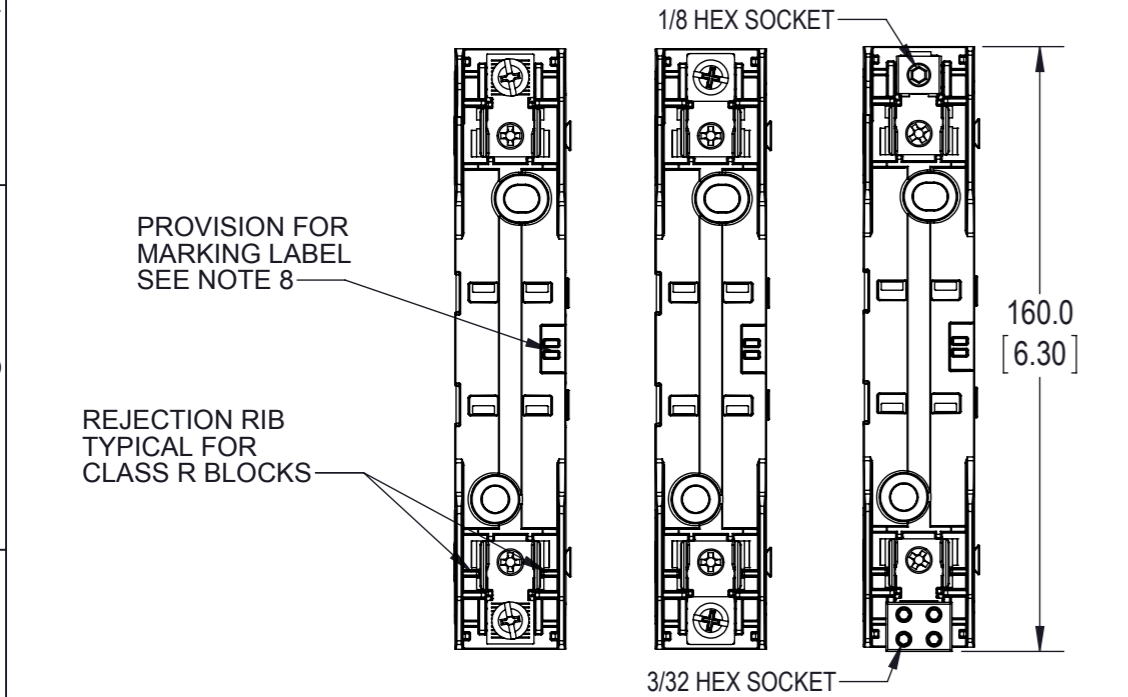

- NOTES:
- VOLTAGE RATING: 600V
 - AMPERAGE: 30A
 - WITHSTAND RATING: CLASS R = 200kA; CLASS H = 10kA
 - WIRE: CU75C/90C
 - CR WIRE RANGE:
 - (1) 2 - 14 AWG CU
 - 2-3: 50 lb-in (5.6 Nm)
 - 4-6, 45 lb-in (5.1 Nm)
 - 8, 40 lb-in (4.5 Nm)
 - 10-14, 35 lb-in (4.0 Nm)
 - (2) 12-14, 50 lb-in (5.6 Nm)
 - MW14 WIRE RANGE:
 - (1) 8-14 AWG CU
 - 8 AWG 3.4 Nm (30 in-lb)
 - 14-10 2.8 Nm (25 in-lb)
 - (2) 12-14 AWG CU
 - 12-14 3.4 Nm (30 in-lb)
 - (1) 8-10 AWG AL
 - 8 Str/10 Sol: 3.4 Nm (30 in-lb)
 - SR/PR WIRE RANGE: (1) 10-18 AWG CU ONLY
 - 10-18 AWG = 20 LB-IN (2.3NM)
 - USE 4MM DIA. CABLE LOCK OR 1/4 INCH DIA. HASP PADLOCK.
 - RECOMMEND USING DIN-RAIL END STOPS FOR DIN RAIL MOUNTED APPLICATIONS
BUSSMANN PART NUMBERS BRKT-ND OR BRKT-NDSCREW2
 - USE BUSMANN MAKER LABEL TM26CB
 - ALL DIMENSIONS ARE TYPICAL UNLESS OTHERWISE INDICATED
 - COVER NOT APPLICABLE FOR RM60030-xMW14 AND HM60030-xMW14 CONFIGURATIONS
 - CHR IS IDENTICAL TO THE -CR EXCEPT WITH A 1/8 INCH HEX WIRE CONNECTOR SCREW

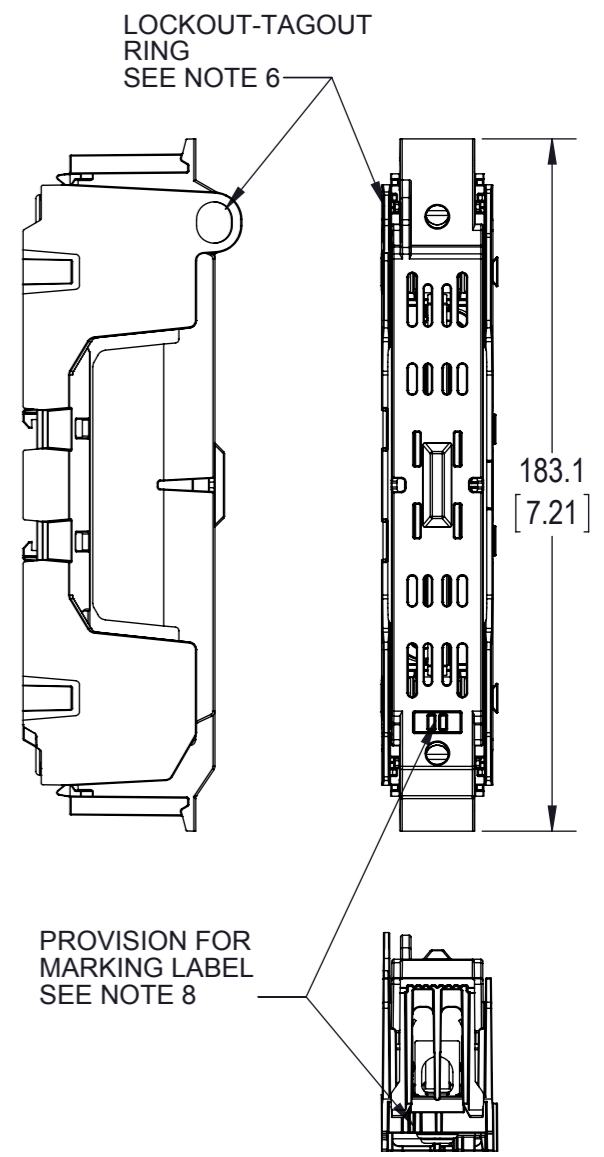
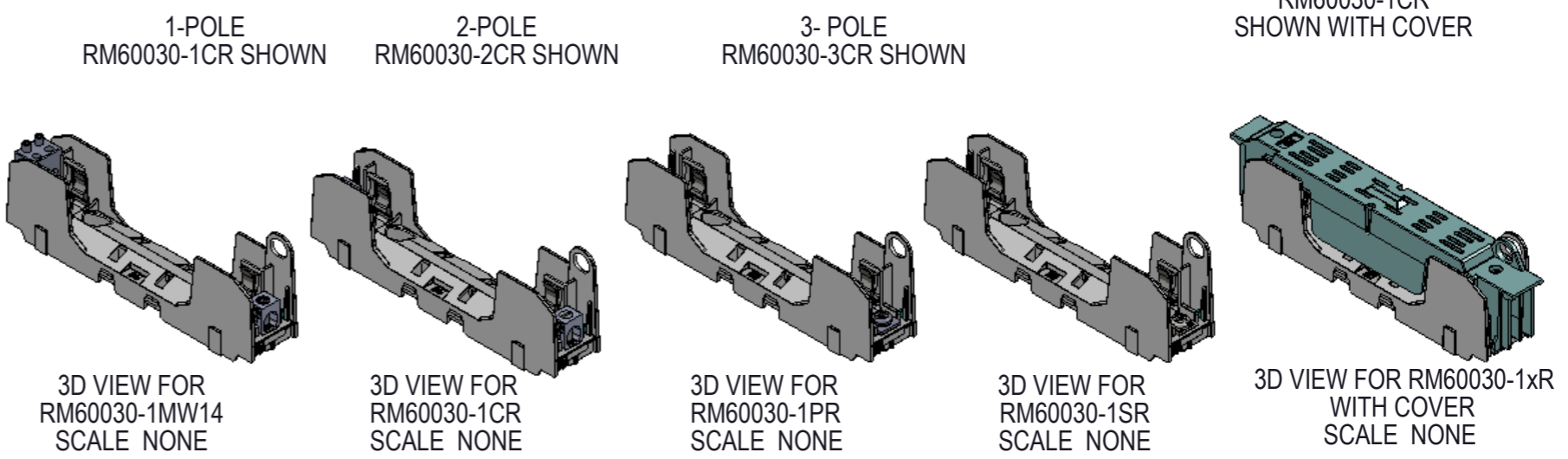
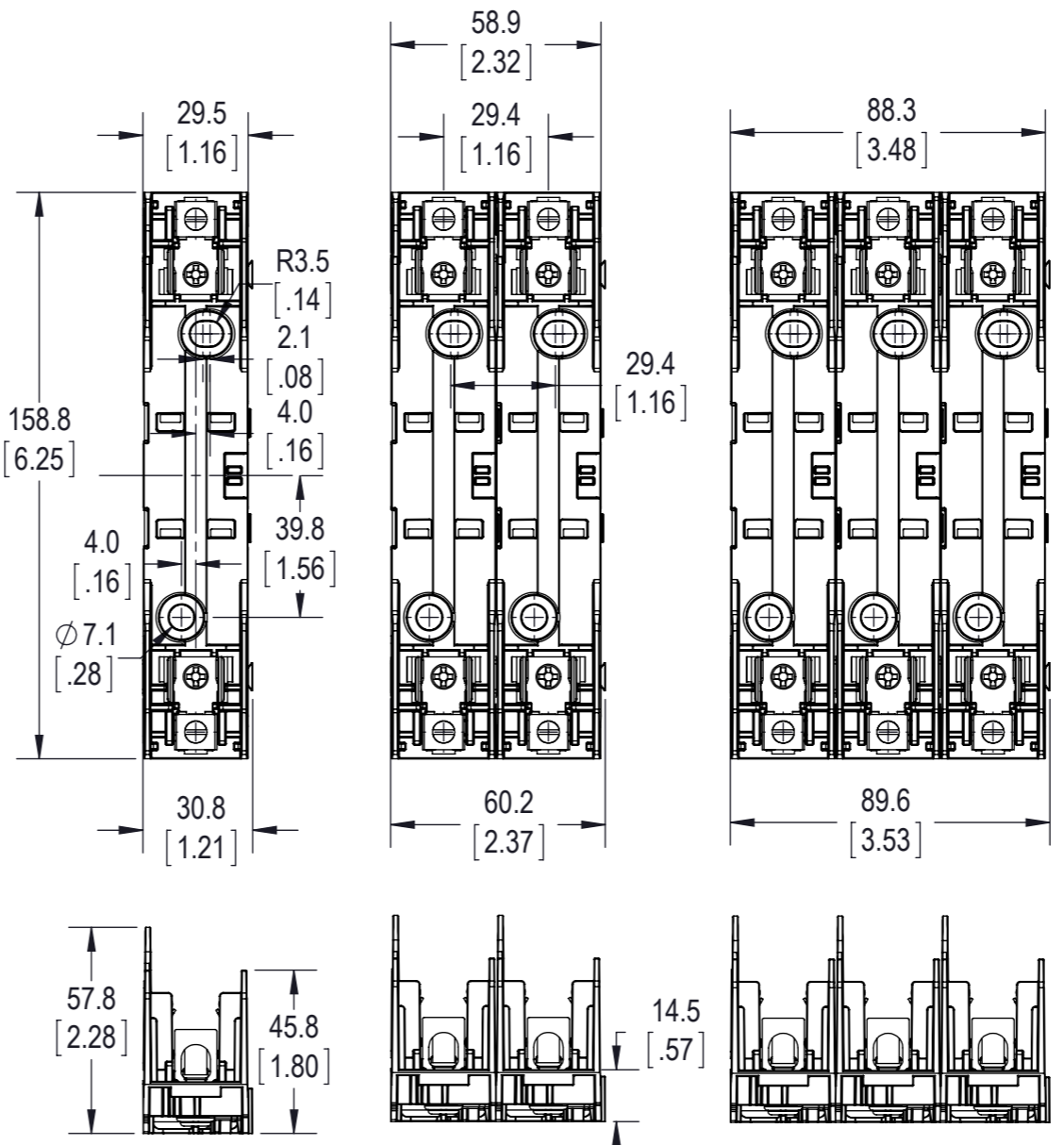

EATON CORPORATION - CONFIDENTIAL AND PROPRIETARY NOTICE TO PERSONS RECEIVING THIS DOCUMENT AND/OR TECHNICAL INFORMATION <small>THIS DOCUMENT, INCLUDING THE DRAWING AND INFORMATION CONTAINED THEREON, IS CONFIDENTIAL AND IS THE EXCLUSIVE PROPERTY OF EATON CORPORATION AND IS MERELY ON LOAN AND SUBJECT TO RECALL BY EATON AT ANY TIME. BY TAKING POSSESSION OF THE DOCUMENT, THE RECIPIENT ACKNOWLEDGES AND AGREES THAT THIS DOCUMENT CANNOT BE USED IN ANY MANNER ADVERSE TO THE INTERESTS OF EATON AND THAT NO PORTION OF THIS DOCUMENT MAY BE COPIED OR OTHERWISE REPRODUCED WITHOUT THE PRIOR WRITTEN CONSENT OF EATON IN THE CASE OF CONFLICTING CONTRACTUAL PROVISIONS. THIS NOTICE SHALL GOVERN THE STATUS OF THIS DOCUMENT.</small> © 2012 Eaton Corporation. All Rights Reserved.		THIS DRAWING IS AN UNCONTROLLED COPY IF PRINTED OR SENT ELECTRONICALLY. DO NOT SCALE DRAWING GENERAL DRAWING PRACTICES IN ACCORDANCE WITH ASME - Y14.100-2004 DIMENSIONS AND TOLERANCES IN ACCORDANCE WITH ASME - Y14.5M-1994 UNLESS OTHERWISE SPECIFIED DIMENSIONS ARE IN MILLIMETERS UNLESS OTHERWISE SPECIFIED TOLERANCES TO BE MILLIMETERS ±.13 mm ANGULAR ± 1°	
CUSTOMER PRINT THIRD ANGLE PROJECTION		EATON BUSSMANN SERIES TITLE: 600V / 30AMP CLASS R & H FUSE BLOCK SIZE: A3 DWG NO.: RM60030-HM60030-SERIES-CP REV: B SCALE: 1:2 SHEET 1 OF 3	

CATALOG NO.	TERMINAL TYPE	IP20 FINGER SAFE C		NO. OF POLES
		W/O INDICATION	INDICATION	
HM60030-1SR	SCREW	CVR-RH-60030	CVRI-RH-60030	1
HM60030-2SR	SCREW			2
HM60030-3SR	SCREW			3
HM60030-1PR	PRESSURE PLATE			1
HM60030-2PR	PRESSURE PLATE			2
HM60030-3PR	PRESSURE PLATE			3
HM60030-1CR	BOX LUG	NA	NA	1
HM60030-2CR	BOX LUG			2
HM60030-3CR	BOX LUG			3
HM60030-1MW14	BOX LUG - 4 PORT MULTIWIRE			1
HM60030-2MW14	BOX LUG - 4 PORT MULTIWIRE			2
HM60030-3MW14	BOX LUG - 4 PORT MULTIWIRE			3

* -CHR ALSO AVAILABLE; SEE NOTE 11

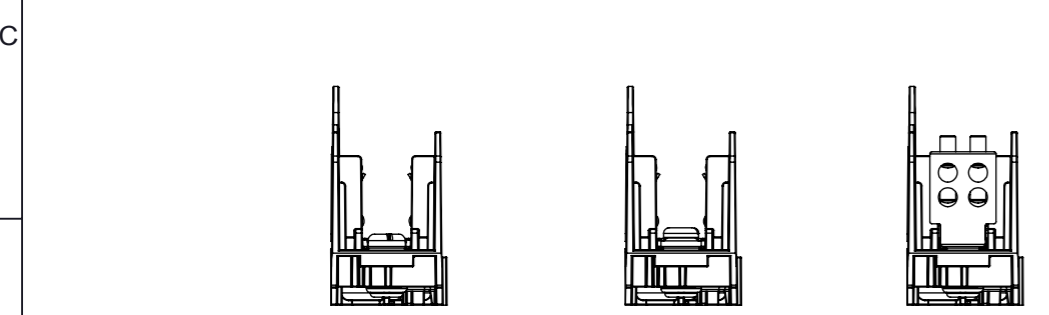
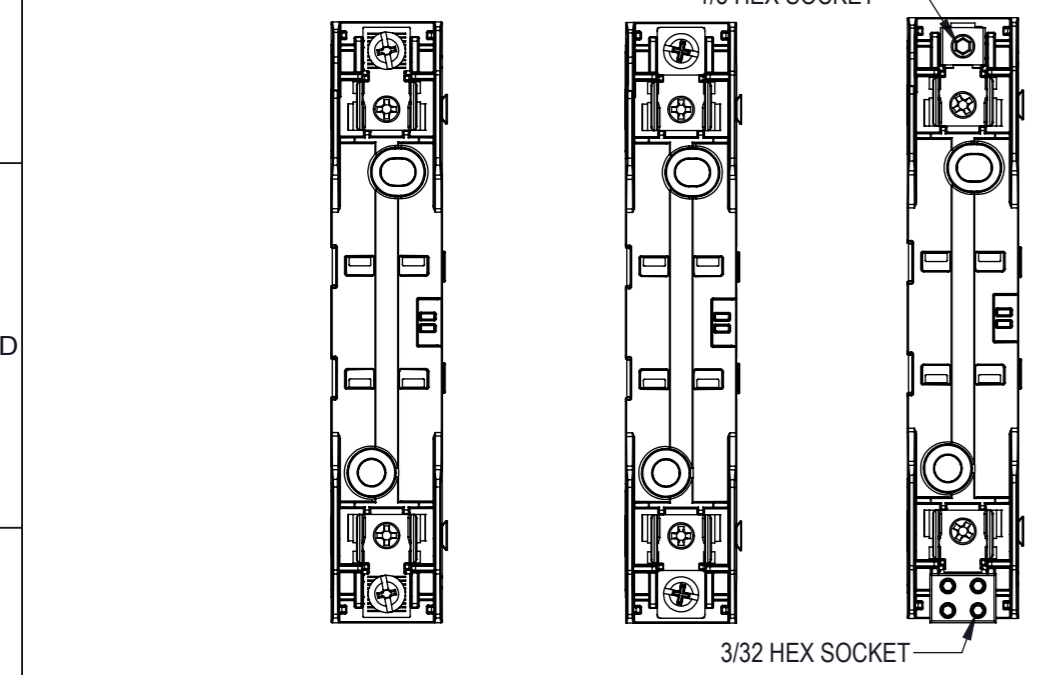

HM60030-1SR HM60030-1PR HM60030-1MW14

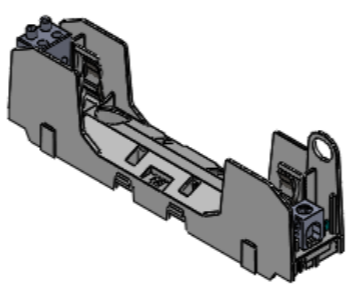

3D VIEW FOR HM60030-1MW14
SCALE NONE

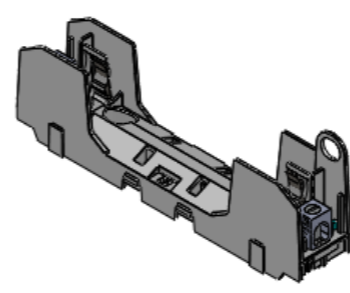

3D VIEW FOR HM60030-1CR
SCALE NONE

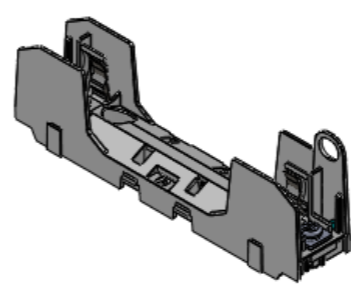

3D VIEW FOR HM60030-1PR
SCALE NONE

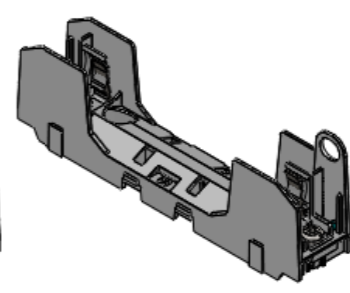

3D VIEW FOR HM60030-1SR
SCALE NONE

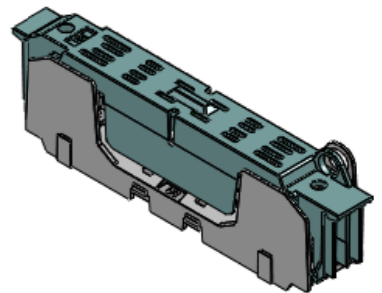

3D VIEW FOR HM60030-1xR
WITH COVER
SCALE NONE

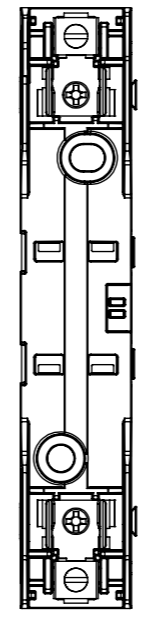

1-POLE
HM60030-1CR SHOWN

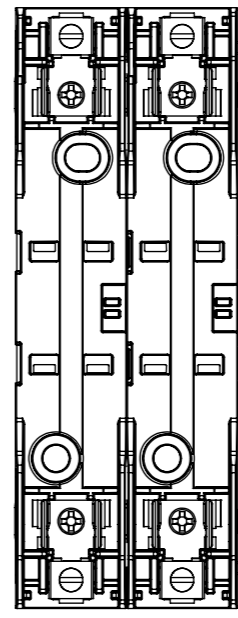

2-POLE
HM60030-2CR SHOWN

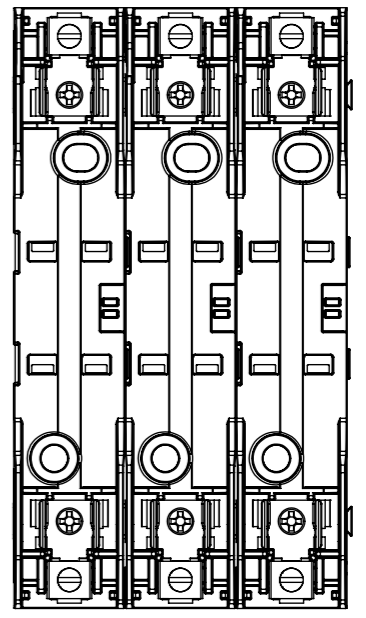

3-POLE
HM60030-3CR SHOWN

EATON BUSSMANN SERIES

TITLE: 600V / 30AMP CLASS R & H FUSE BLOCK

SIZE: A3 DWG NO.: RM60030-HM60030-SERIES-CP REV: B

SCALE: 1:2 SHEET: 2 OF 3