

## HMA SERIES – AMPLIFIED PRESSURE SENSORS

The HMA pressure sensors provide amplified analog output signals and utilize precision digital signal conditioning to achieve high accuracies. The sensors offer an increased media compatibility to measure gases and liquids. 5 V and 3 V supply versions are available. Very small SIL and DIP housings allow for space- saving PCB-mounting. All HMA pressure sensors can be modified according to customer specific requirements.

### Features

- Pressure ranges from 2.5 mbar to 10 bar, 1 psi to 150 psi gage or differential pressure
- Increased media compatibility <sup>(1)</sup>
- Analog output
- Precision ASIC signal conditioning
- Calibrated and temperature compensated <sup>(2)</sup>
- SIL and DIP housings

### Applications

- Industrial controls
- Pneumatic controls
- Environmental controls
- HVAC
- Analytical instruments

### Certificates

- Quality Management System according to EN ISO 13485:2003 and EN ISO 9001:2008
- RoHS and REACH compliant

### Media compatibility <sup>(1), (2)</sup>

High pressure port: To be used with gases and liquids which are compatible with the wetted materials (high temperature polyamide, ceramic AL<sub>2</sub>O<sub>3</sub>, epoxy, fluorosilicate, glass, silicon).

Low pressure port: To be used with non-corrosive, non-ionic working fluids such as clean dry air, dry gases and the like.

[CLICK HERE >](#)  
**CONNECT WITH A SPECIALIST**

## HMA SERIES – AMPLIFIED PRESSURE SENSORS

### Maximum ratings

Parameter		Min.	Typ.	Max.	Unit
Supply voltage (V <sub>S</sub> ) <sup>(3)</sup>	HMAxxx3	2.7	3.0	4.2	V <sub>DC</sub>
	HMAxxx5	4.2	5.0	5.5	
Output current	Sink		1		mA
	Source		1		
Temperature ranges	Compensated	-20		+85	°C
	Operating	-20		+85	
	Storage <sup>(4)</sup>	-40		+125	
Humidity limits (non-condensing) <sup>(5)</sup>				95	%RH
Vibration	10 to 2000 Hz, random (EN 60068-2-64)			10	g
Mechanical shock	11 ms (EN60068-2-27)			50	
Lead solder temperature	(JESD22-B106D)			270	°C

### Pressure sensor characteristics

Part no.	Operating pressure	Proof pressure <sup>(6)</sup>
HMAM2x5Uxxx	0 to 2.5 mbar	100 mbar
HMAM2x5Bxxx	0 to ±2.5 mbar	
HMAM005Uxxx	0 to 5 mbar	
HMAM005Bxxx	0 to ±5 mbar	
HMAM010Uxxx	0 to 10 mbar	
HMAM010Bxxx	0 to ±10 mbar	
HMAM020Uxxx	0 to 20 mbar	300 mbar
HMAM020Bxxx	0 to ±20 mbar	
HMAM050Uxxx	0 to 50 mbar	
HMAM050Bxxx	0 to ±50 mbar	
HMAM100Uxxx	0 to 100 mbar	2 bar
HMAM100Bxxx	0 to ±100 mbar	
HMAM250Uxxx	0 to 250 mbar	5 bar
HMAM250Bxxx	0 to ±250 mbar	
HMAB001Uxxx	0 to 1 bar	10 bar
HMAB001Bxxx	0 to ±1 bar	
HMAB2x5Uxxx	0 2.5 bar	14 bar
HMAB005Uxxx	0 to 5 bar	
HMAB010Uxxx	0 to 10 bar	30 psi
HMAP001Uxxx	0 to 1 psi	
HMAP001Bxxx	0 to ±1 psi	
HMAP100Uxxx	0 to 100 psi	200 psi

Other pressure ranges are available on request. Please contact your local sensors representative.

## HMA SERIES – AMPLIFIED PRESSURE SENSORS

### Performance characteristics – 5 V devices <sup>(7)</sup>

(V<sub>S</sub>=5.0 V<sub>DC</sub>, T<sub>A</sub>=25 °C, RH=50 %, analog output signal is ratiometric to V<sub>S</sub> in the range of V<sub>S</sub> =4.2 to 5.5 V)

Parameter	Min.	Typ.	Max.	Unit
Non-linearity (-20...85 °C) <sup>(8)</sup>			±0.25	%FSS
Accuracy <sup>(9)</sup>			±0.25	
Total accuracy (-20...85 °C) <sup>(10)</sup>	up to 5 mbar		±2	
	10 mbar to 50 mbar / 1 psi		±1.25	
	all others		±0.75	
Response delay <sup>(11)</sup>		0.5		ms
A/D resolution		12		bit
D/A resolution			11	
Current consumption	<1 bar	4.2		mA
	All others	5.3		

### Pressure ranges up to 5 mbar

#### Unidirectional devices

Parameter	Min.	Typ.	Max.	Unit
Zero pressure offset	0.42	0.50	0.58	V
Full scale span (FSS) <sup>(12)</sup>		4.00		
Full scale output	4.42	4.50	4.58	

#### Bidirectional devices

Parameter	Min.	Typ.	Max.	Unit	
Zero pressure offset	2.42	2.50	2.58	V	
Full scale span (FSS) <sup>(12)</sup>		4.00			
Full scale output	@ max. specified pressure	4.42	4.50		4.58
	@ min. specified pressure	0.42	0.50		0.58

### Pressure ranges from 10 mbar to 50 mbar / 1 psi

#### Unidirectional devices

Parameter	Min.	Typ.	Max.	Unit
Zero pressure offset	0.45	0.50	0.55	V
Full scale span (FSS) <sup>(12)</sup>		4.00		
Full scale output	4.45	4.50	4.55	

#### Bidirectional devices

Parameter	Min.	Typ.	Max.	Unit	
Zero pressure offset	2.45	2.50	2.55	V	
Full scale span (FSS) <sup>(12)</sup>		4.00			
Full scale output	@ max. specified pressure	4.45	4.50		4.55
	@ min. specified pressure	0.45	0.50		0.55

## HMA SERIES – AMPLIFIED PRESSURE SENSORS

### Performance characteristics – 5 V devices (cont.)<sup>(7)</sup>

( $V_S=5.0 V_{DC}$ ,  $T_A=25\text{ }^\circ\text{C}$ ,  $RH=50\%$ , analog output signal is ratiometric to  $V_S$  in the range of  $V_S = 4.2$  to  $5.5 V$ )

#### All other pressure ranges

##### Unidirectional devices

Parameter	Min.	Typ.	Max.	Unit
Zero pressure offset	0.47	0.50	0.53	V
Full scale span (FSS) <sup>(12)</sup>		4.00		
Full scale output	4.47	4.50	4.53	

##### Bidirectional devices

Parameter	Min.	Typ.	Max.	Unit
Zero pressure offset	2.47	2.50	2.53	V
Full scale span (FSS) <sup>(12)</sup>		4.00		
Full scale output	@ max. specified pressure	4.47	4.53	
	@ min. specified pressure	0.47	0.50	

### Performance characteristics – 3 V devices<sup>(7)</sup>

( $V_S=3.0 V_{DC}$ ,  $T_A=25\text{ }^\circ\text{C}$ ,  $RH=50\%$ , analog output signal is ratiometric to  $V_S$  in the range of  $V_S = 2.7$  to  $4.2 V$ )

Parameter	Min.	Typ.	Max.	Unit
Non-linearity (-20...85 °C) <sup>(8)</sup>			±0.25	%FSS
Accuracy <sup>(9)</sup>			±0.25	
Total accuracy (-20...85 °C) <sup>(10)</sup>	up to 5 mbar		±2	
	10 mbar to 50 mbar / 1 psi		±1.25	
	all others		±0.75	
Response delay <sup>(11)</sup>		0.5		ms
A/D resolution		12		bit
D/A resolution			11	
Current consumption	<1 bar	3.7		mA
	All others	4.5		

#### Pressure ranges up to 5 mbar

##### Unidirectional devices

Parameter	Min.	Typ.	Max.	Unit
Zero pressure offset	0.252	0.30	0.348	V
Full scale span (FSS) <sup>(12)</sup>		2.40		
Full scale output	2.652	2.70	2.748	

##### Bidirectional devices

Parameter	Min.	Typ.	Max.	Unit
Zero pressure offset	1.452	1.50	1.548	V
Full scale span (FSS) <sup>(12)</sup>		2.40		
Full scale output	@ max. specified pressure	2.652	2.748	
	@ min. specified pressure	0.252	0.348	

## HMA SERIES – AMPLIFIED PRESSURE SENSORS

### Performance characteristics – 3 V devices (cont.) <sup>(7)</sup>

( $V_S=3.0 V_{DC}$ ,  $T_A=25\text{ }^\circ\text{C}$ ,  $RH=50\%$ , analog output signal is ratiometric to  $V_S$  in the range of  $V_S = 2.7$  to  $4.2 V$ )

### Pressure ranges from 10 mbar to 50 mbar / 1 psi

#### Unidirectional devices

Parameter	Min.	Typ.	Max.	Unit
Zero pressure offset	0.27	0.30	0.33	V
Full scale span (FSS) <sup>(12)</sup>		2.40		
Full scale output	2.67	2.70	2.73	

#### Bidirectional devices

Parameter	Min.	Typ.	Max.	Unit
Zero pressure offset	1.47	1.50	1.53	V
Full scale span (FSS) <sup>(12)</sup>		2.40		
Full scale output	@ max. specified pressure	2.70	2.73	
	@ min. specified pressure	0.30	0.33	

### All other pressure ranges

#### Unidirectional devices

Parameter	Min.	Typ.	Max.	Unit
Zero pressure offset	0.282	0.30	0.318	V
Full scale span (FSS) <sup>(12)</sup>		2.40		
Full scale output	2.682	2.70	2.718	

#### Bidirectional devices

Parameter	Min.	Typ.	Max.	Unit
Zero pressure offset	1.482	1.50	1.518	V
Full scale span (FSS) <sup>(12)</sup>		2.40		
Full scale output	@ max. specified pressure	2.70	2.718	
	@ min. specified pressure	0.30	0.318	

# HMA SERIES – AMPLIFIED PRESSURE SENSORS

## Dimensional drawing

### HMAxxxU1xxx (SIL, axial no ports)

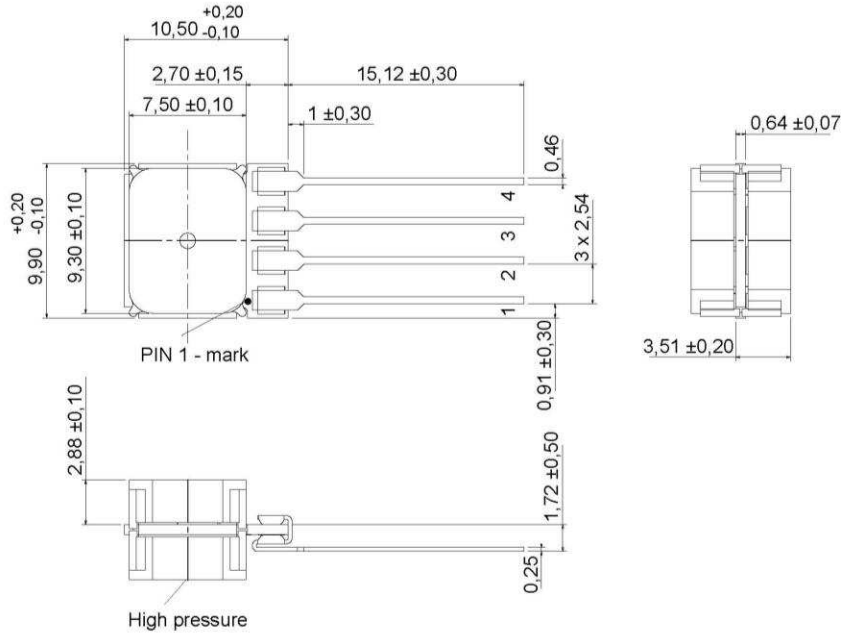

## Electrical connection

Pin	connection
1	+Vs
2	GND
3	+Vout
4	C

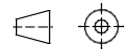

first angle projection  
dimensions in mm

### HMAxxxW1xxx (DIP, axial no ports)

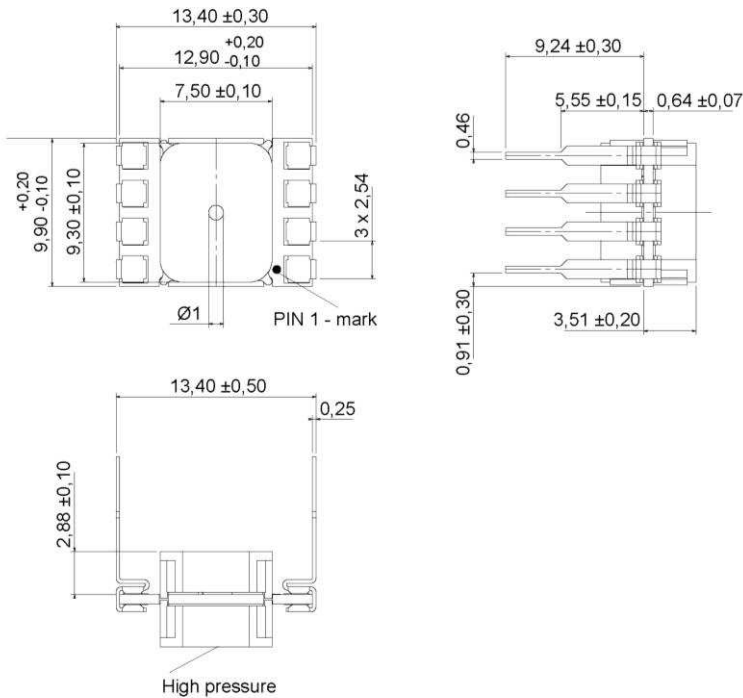

Pin	connection
1	+Vs
2	GND
3	+Vout
4	C
5	I/C*
6	I/C*
7	I/C*
8	I/C*

\*internal connection. Do not connect for any reason

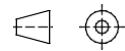

first angle projection  
dimensions in mm

# HMA SERIES – AMPLIFIED PRESSURE SENSORS

## Dimensional drawing

### HMAxxxX7xxx (SIL, 1 port axial, barbed)

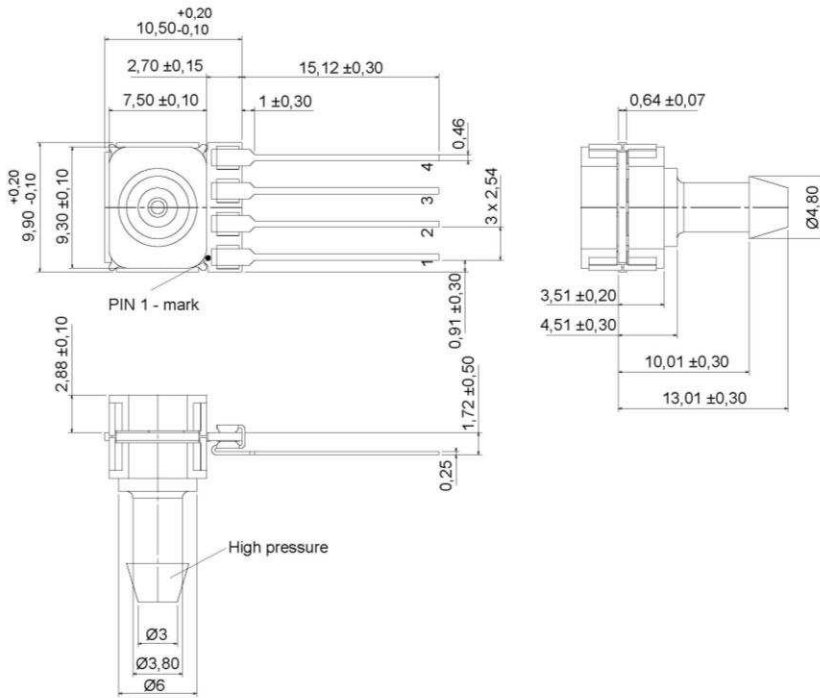

## Electrical connection

Pin	connection
1	+Vs
2	GND
3	+Vout
4	C

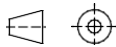
  
first angle projection  
dimensions in mm

### HMAxxxU7xxx (SIL, 2 ports axial, opposite side, barbed)

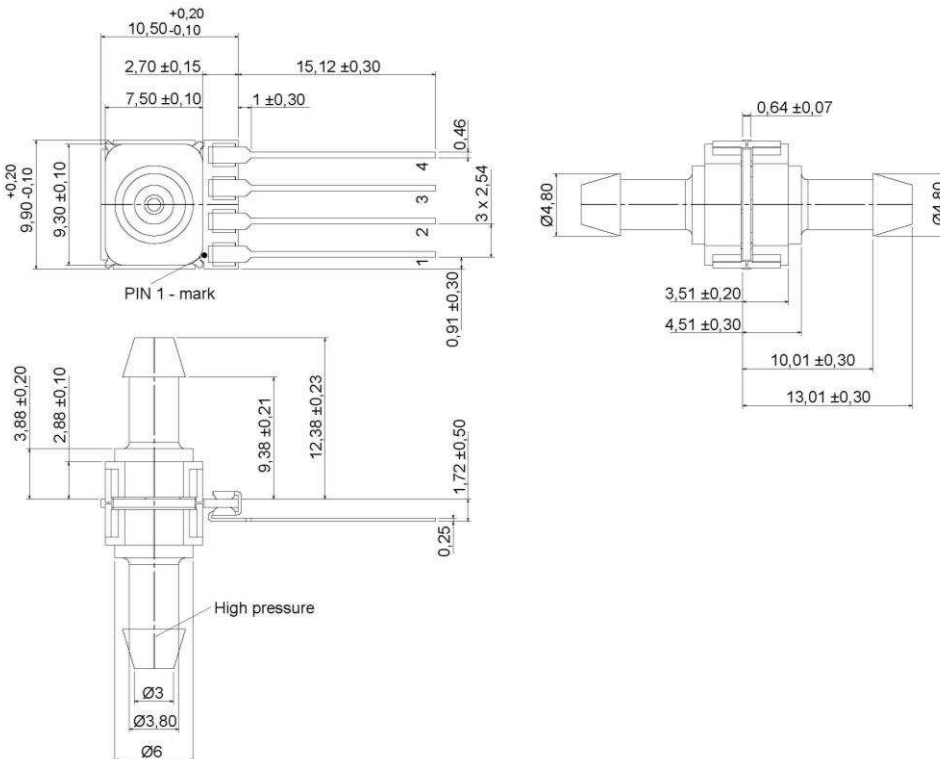

Pin	connection
1	+Vs
2	GND
3	+Vout
4	C

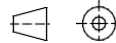
  
first angle projection  
dimensions in mm

# HMA SERIES – AMPLIFIED PRESSURE SENSORS

## Dimensional drawing

### HMAxxxZ7xxx (DIP, 1 port axial, barbed)

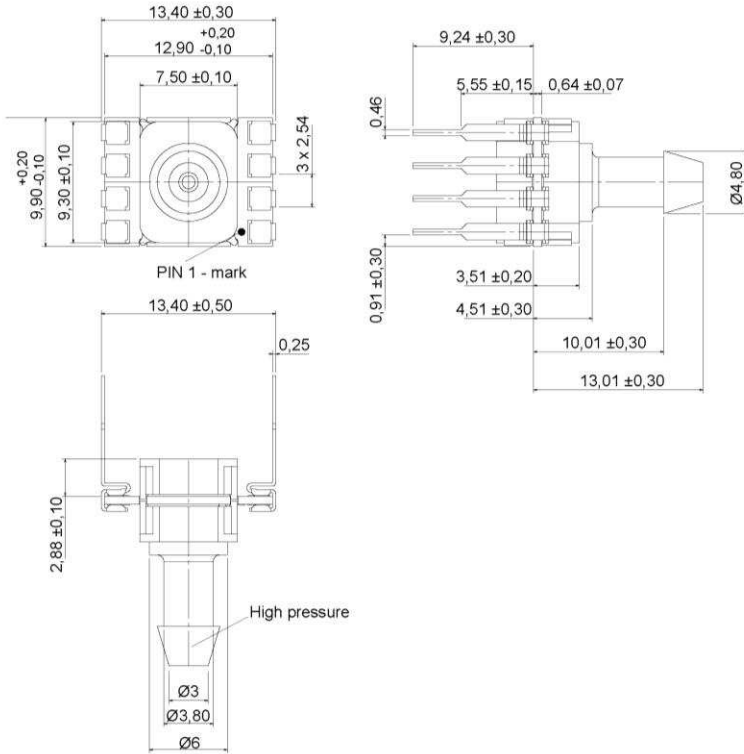

## Electrical connection

Pin	connection
1	+Vs
2	GND
3	+Vout
4	C
5	I/C*
6	I/C*
7	I/C*
8	I/C*

\* internal connection. Do not connect for any reason

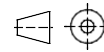

first angle projection  
dimensions in mm

### HMAxxxU6xxx (SIL, 2 ports axial, opposite side, straight big)

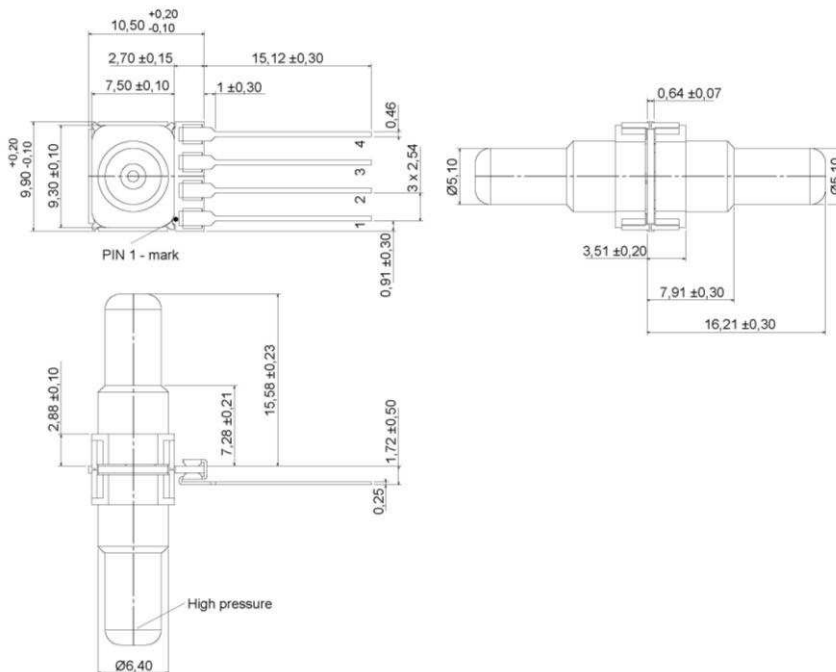

Pin	connection
1	+Vs
2	GND
3	+Vout
4	C



first angle projection  
dimensions in mm



# HMA SERIES – AMPLIFIED PRESSURE SENSORS

## Dimensional drawing

### HMAxxxX6xxx (SIL, 1 port axial, straight big)

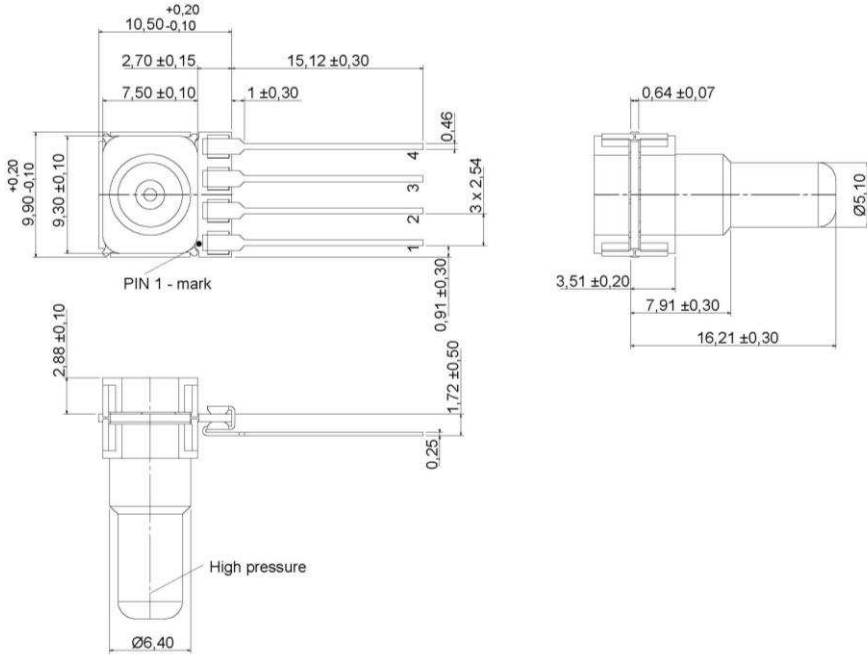

## Electrical connection

Pin	connection
1	+Vs
2	GND
3	+Vout
4	C

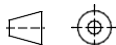
  
first angle projection  
dimensions in mm

### HMAxxxZ6xxx (DIP, 1 port axial, straight big)

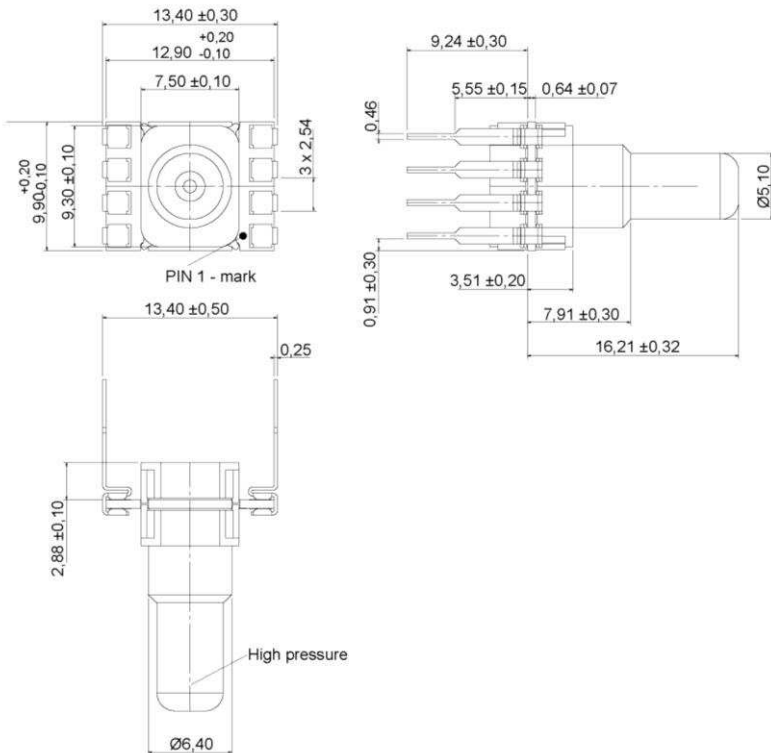

Pin	connection
1	+Vs
2	GND
3	+Vout
4	C
5	I/C*
6	I/C*
7	I/C*
8	I/C*

\* internal connection. Do not connect for any reason

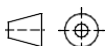
  
first angle projection  
dimensions in mm

# HMA SERIES – AMPLIFIED PRESSURE SENSORS

## Dimensional drawing

### HMAxxxU5xxx (SIL, 2 ports axial, opposite side, needle big)

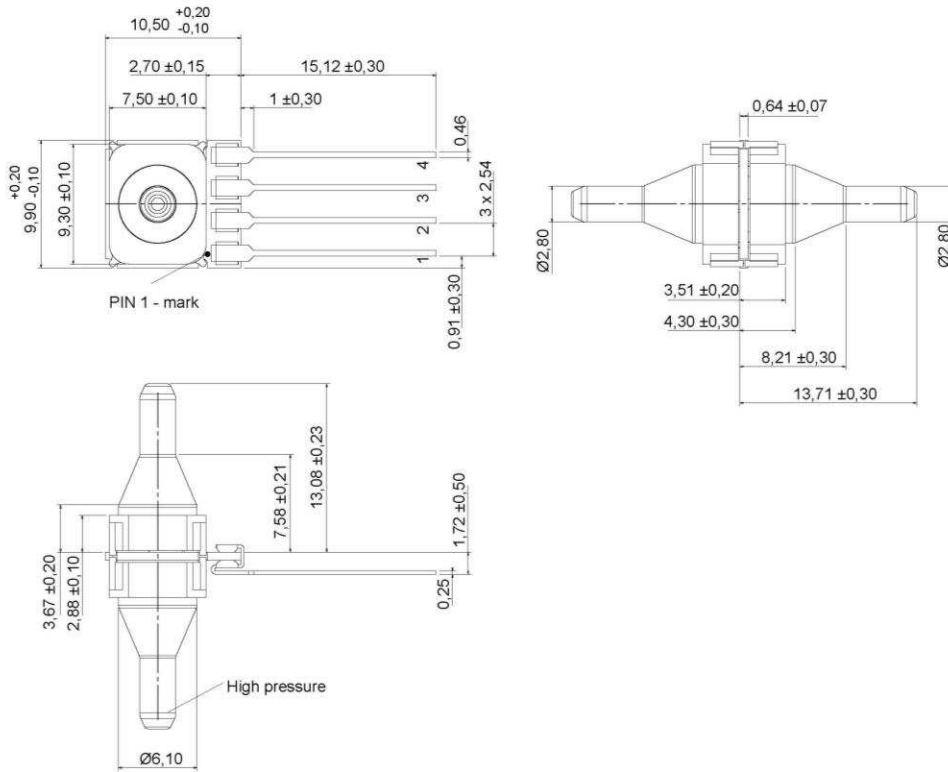

## Electrical connection

Pin	connection
1	+Vs
2	GND
3	+Vout
4	C

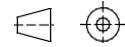

first angle projection  
dimensions in mm

### HMAxxxX5xxx (SIL, 1 port axial, needle big)

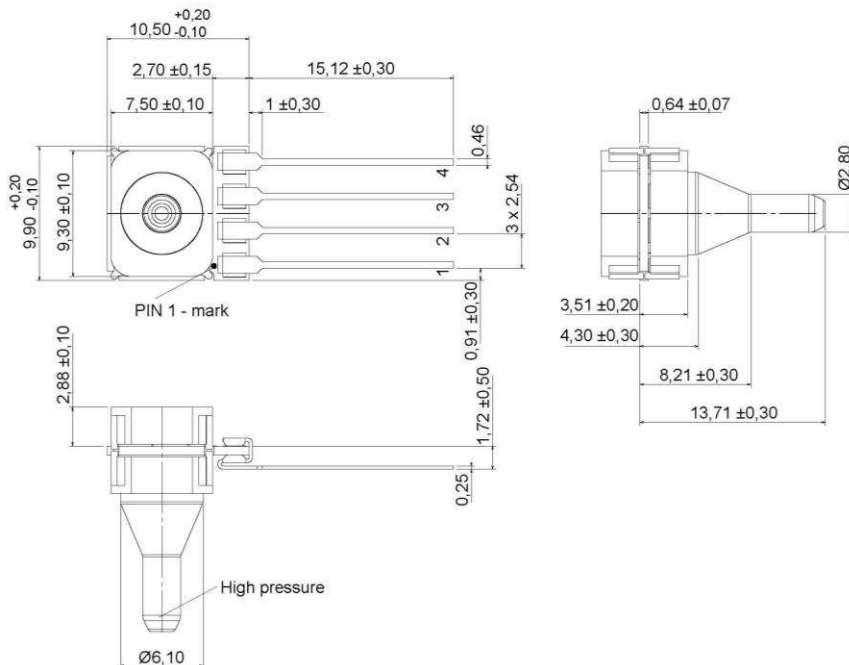

Pin	connection
1	+Vs
2	GND
3	+Vout
4	C

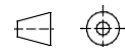

first angle projection  
dimensions in mm

# HMA SERIES – AMPLIFIED PRESSURE SENSORS

## Dimensional drawing

HMAxxxZ5xxx (DIP, 1 port axial, needle big)

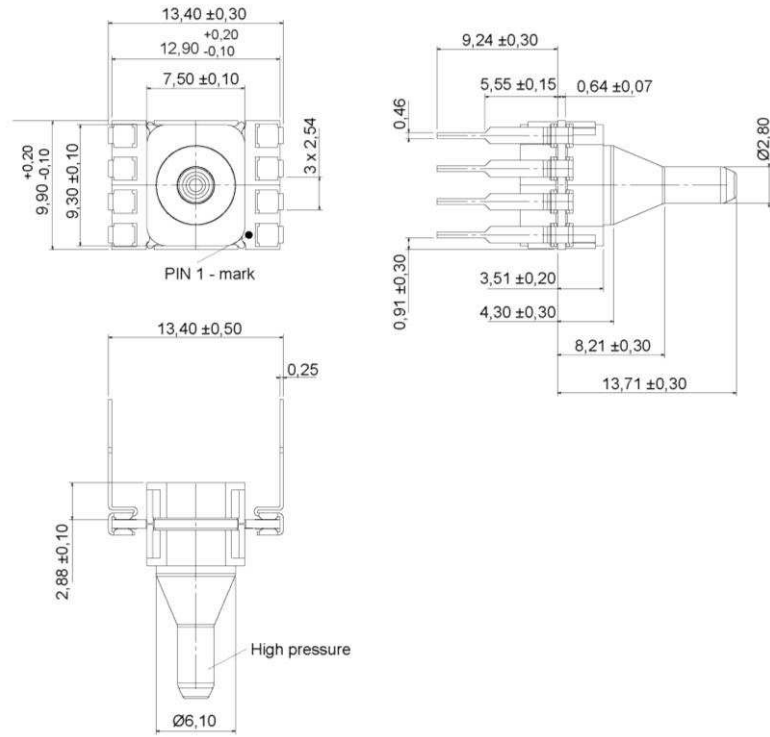

## Electrical connection

Pin	connection
1	+Vs
2	GND
3	+Vout
4	C
5	I/C*
6	I/C*
7	I/C*
8	I/C*

\*Internal connection. Do not connect for any reason.

 first angle projection  
dimensions in mm

## Electrical connection (cont.)

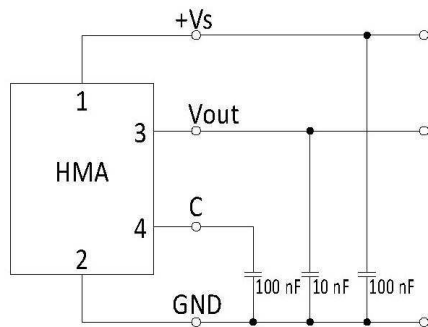

# HMA SERIES – AMPLIFIED PRESSURE SENSORS

## Part numbering key

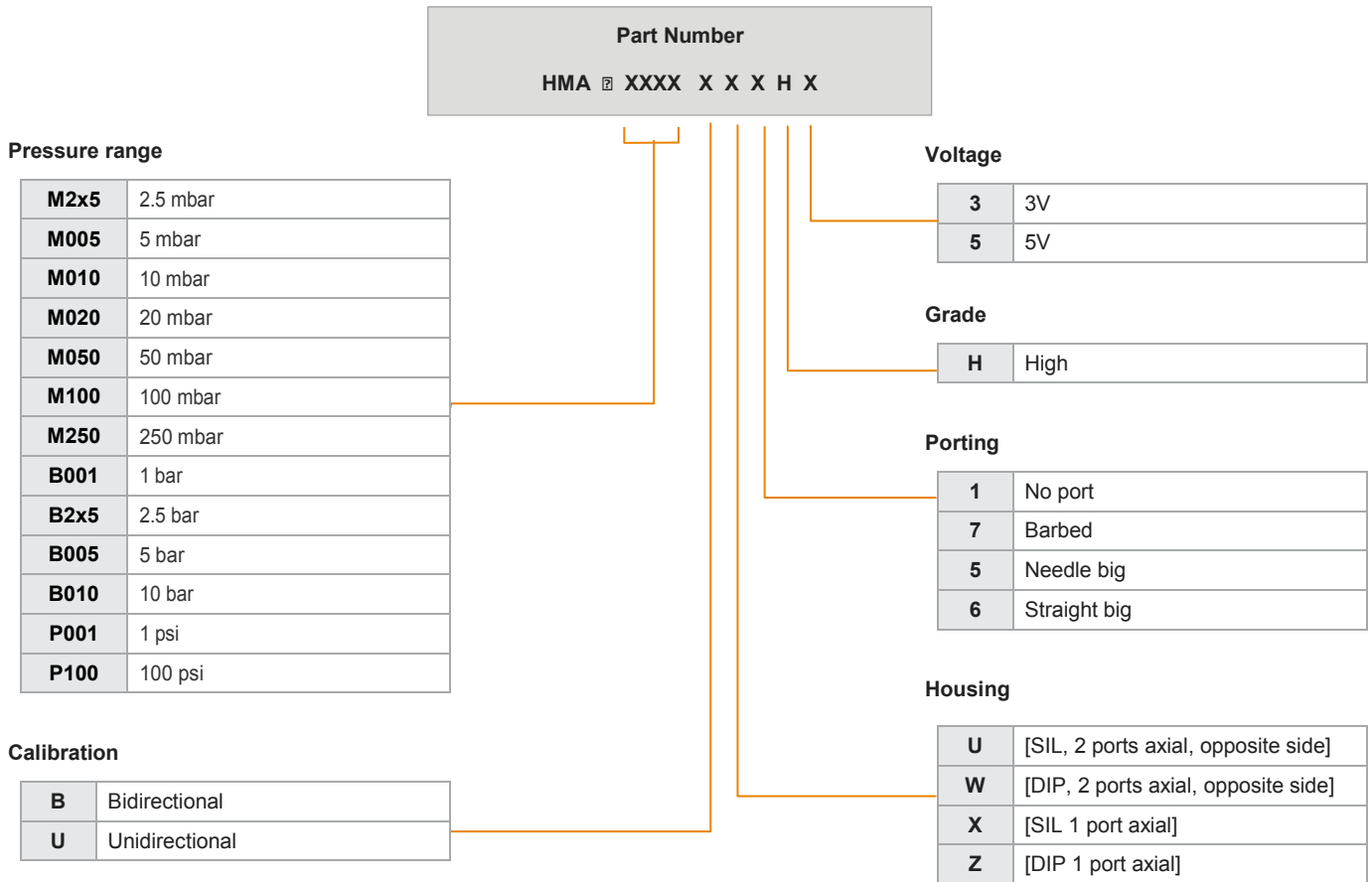

**Order code example: HMAB001BX7H5**

## HMA SERIES – AMPLIFIED PRESSURE SENSORS

### Label information

Digit	1	2	3	4	5	6	7	8	9	10	11	12	13	14			
	Series			Pressure range		Calibration		Housing		Porting		Grade / voltage		Rev	Date code (year)	Production code	
Char	M	A	HMA	1	2.5 mbar	U	Unidirectional	U	SIL, 2 ports axial, opposite side	1	no port	-	High, 5 V				
				2	5 mbar	B	Bidirectional			7	Barbed	/	High, 3 V				
				3	10 mbar			W	DIP, 2 ports axial, opposite side	5	Needle big						
				4	20 mbar					6	Straight big						
				5	50 mbar			X	SIL, 1 port axial								
				6	1 psi			Z	DIP; 1 port axial								
				7	100 mbar												
				8	250 mbar												
				A	1 bar												
				B	2.5 bar												
				C	5 bar												
				L	100 psi												
				M	10 bar												

### Ordering information (standard configurations)

Description	TE Part Number	Pressure Range	Calibration	Housing	Porting	Grade	Voltage
HMAM250UU7H5	2003564-F	250 mbar	Unidirectional	SIL, 2 ports axial, opposite side	Barbed	High	5 V
HMAB001BZ7H5	2003649-F	1 bar	Bidirectional	DIP 1 port axial	Barbed	High	5 V
HMAB2X5UW1H3	2003885-F	2.5 bar	Unidirectional	DIP, 2 ports axial, opposite side	No port	High	3 V
HMAP100UZ5H5	2003752-F	100 psi	Unidirectional	DIP 1 port axial	Needle big	High	5 V
HMAB010UZ7H5	2003574-F	10 bar	Unidirectional	DIP 1 port axial	Barbed	High	5 V

#### Note:

The above product listings are examples of possible product configurations. More standard product configurations are available on request. In addition, custom specific pressure and temperature ranges as well as mechanical or electronic sensor modifications are widely available. Please note, not all possible sensor configurations are active products. MOQ may apply. Please contact your local sensors representative to learn more.