

### Typical Applications

The HMC253ALC4 is ideal for:

- Basestations & Repeaters
- WiMAX/WiBro & Fixed Wireless
- Cellular/3G Infrastructure
- CATV/DBS
- Military & Hi-Rel

### Features

- Ceramic, RoHS Compliant 4x4 mm SMT Package
- Non-Reflective Topology
- Low Insertion Loss: 1.6 dB
- Single Positive Supply:  $V_{dd} = +5V$
- Integrated 3:8 TTL/CMOS Decoder: 0/+3V

### Functional Diagram

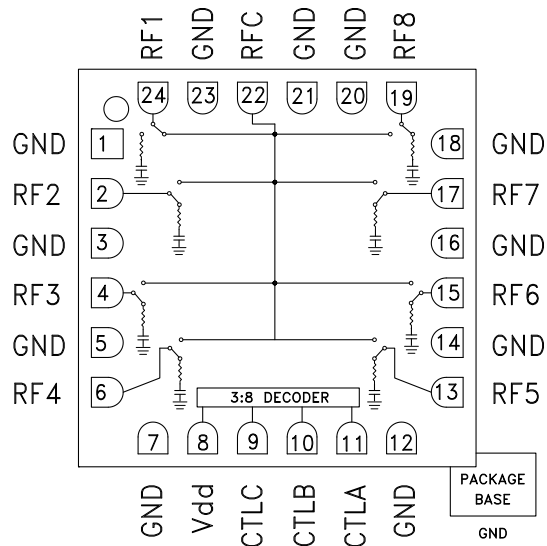

### General Description

The HMC253ALC4 is a non-reflective SP8T switch in a leadless RoHS compliant 4x4 mm ceramic SMT package featuring wideband operation from DC to 3.5 GHz. The switch offers a single positive bias and true TTL/CMOS compatibility enabling it to operate with 0/+3V control and a +5V supply. A 3:8 decoder is integrated on the switch requiring only 3 control lines and a positive bias to select each path. The HMC253ALC4 SP8T will replace multiple configurations of SP4T and SPDT MMIC switches.

### Electrical Specifications,

$T_A = +25^\circ C$ , For TTL Control and  $V_{dd} = +5V$  in a 50 Ohm system

Parameter	Frequency	Min.	Typ.	Max.	Units
Insertion Loss	DC - 2.0 GHz		1.1	1.5	dB
	DC - 3.0 GHz		1.6	2.0	dB
	DC - 3.5 GHz		1.9	2.4	dB
Isolation	DC - 2.0 GHz	38	43		dB
	DC - 3.0 GHz	34	39		dB
	DC - 3.5 GHz	30	35		dB
Return Loss	"On State"	0.3 - 3.0 GHz		13	dB
		0.3 - 3.5 GHz		10	dB
Return Loss (RF1-8)	"Off State"	0.3 - 3.5 GHz		10	dB
		0.5 - 3.5 GHz		14	dB
Input Power for 1 dB Compression	0.5 - 3.5 GHz	20	24		dBm
Input Third Order Intercept (Two-Tone Input Power = +10 dBm Each Tone)	0.5 - 3.5 GHz	40	43		dBm
Switching Characteristics	0.3 - 3.5 GHz				
tRISE, tFALL (10/90% RF)			30		ns
tON, tOFF (50% CTL to 10/90% RF)			100		ns



**GaAs MIMIC SP8T NON-REFLECTIVE SWITCH, DC - 3.5 GHz**

**Insertion Loss**

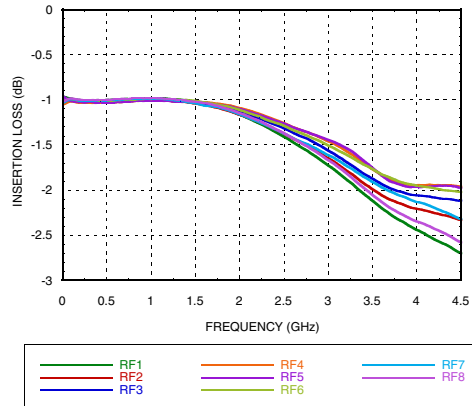

**Insertion Loss vs. Temperature**

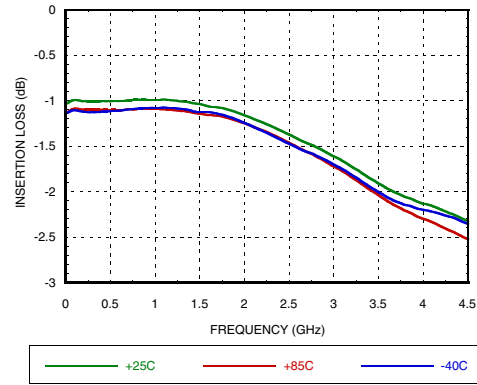

**Return Loss**

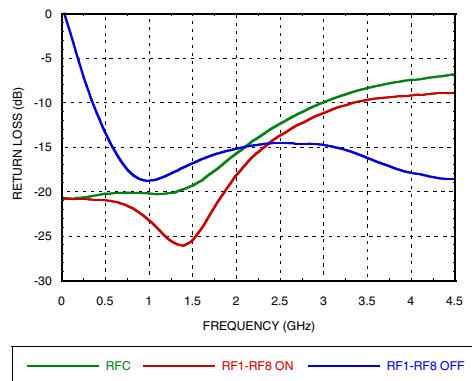

**Isolation**

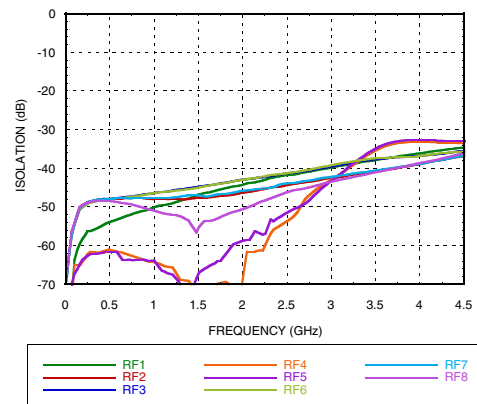

**Input IP3**

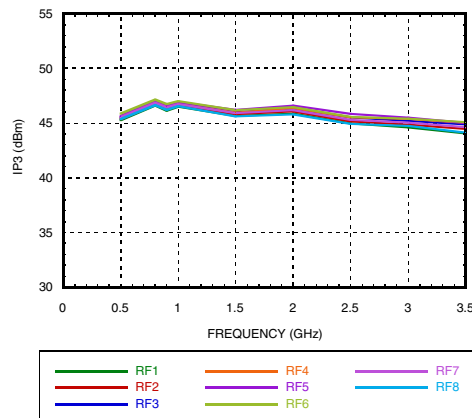

**Input Compression**

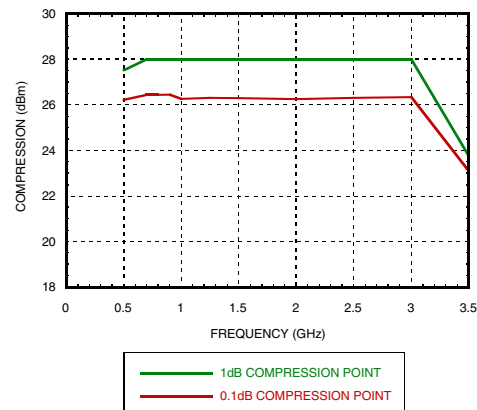

**GaAs MIMIC SP8T NON-REFLECTIVE SWITCH, DC - 3.5 GHz**
**Bias Voltage & Current**

Vdd Range = +5 Vdc ± 10%		
Vdd (Vdc)	Idd (Typ.) (mA)	Idd (Max.) (mA)
+5	4.5	7.5

**TTL/CMOS Control Voltages**

State	Bias Condition
Low	0 to +0.8 Vdc @ <1 μA Typ.
High	+2.0 to +5 Vdc @ 60 μA Typ.

**NOTE:**

DC Blocking capacitors are required at ports RFC and RF1, 2, 3, 4, 5, 6, 7, 8.

**Truth Table**

Control Input			Signal Path State
A	B	C	RFCOM to:
Low	Low	Low	RF1
High	Low	Low	RF2
Low	High	Low	RF3
High	High	Low	RF4
Low	Low	High	RF5
High	Low	High	RF6
Low	High	High	RF7
High	High	High	RF8

**ELECTROSTATIC SENSITIVE DEVICE  
OBSERVE HANDLING PRECAUTIONS**
**Absolute Maximum Ratings**

Bias Voltage Range (Port Vdd)	+7.0 Vdc
Control Voltage Range (A, B, C)	-0.5V to Vdd +1Vdc
Channel Temperature	150 °C
Thermal Resistance (channel to package ground paddle)	
Through Path	183 °C/W
Termination Path	274 °C/W
Storage Temperature	-65 to +150 °C
Operating Temperature	-40 to +85 °C
Maximum Input Power (Vdd = +5V)	
Through Path	+20 dBm (0.05 - 0.5 GHz) +25 dBm (0.5 - 3.5 GHz)
Terminated Path	+20 dBm (0.05 - 0.5 GHz) +23.5 dBm (0.5 - 3.5 GHz)
ESD Sensitivity (HBM)	Class 1A

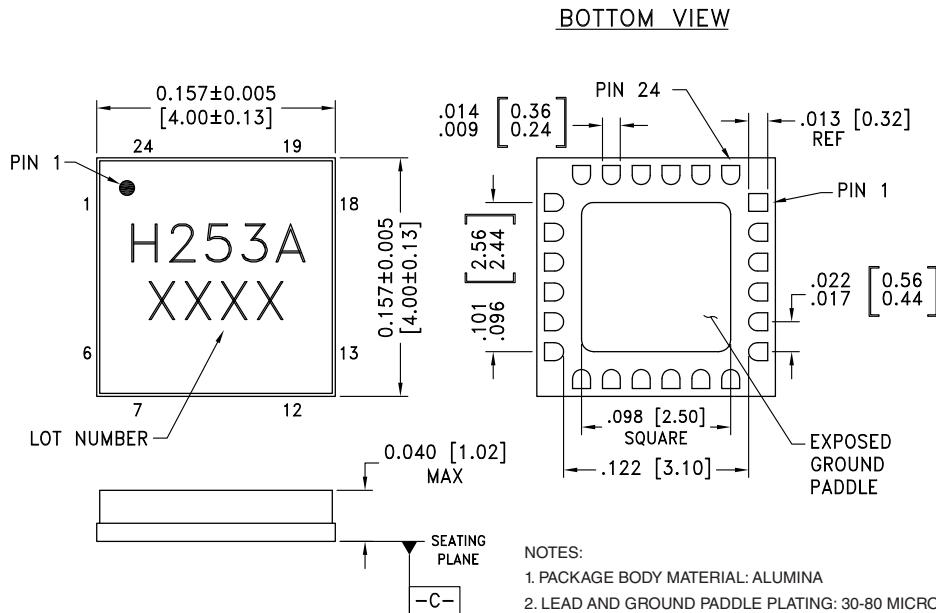
**GaAs MIMIC SP8T NON-REFLECTIVE SWITCH, DC - 3.5 GHz**
**Outline Drawing**

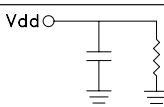
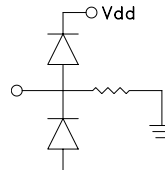
**Pin Descriptions**

Pin Number	Function	Description	Interface Schematic
1, 3, 5, 7, 12, 14, 16, 18, 20, 21, 23	GND	Package bottom has exposed metal paddle that must also be connected to RF ground.	
2, 4, 6, 13, 15, 17, 19, 22, 24	RF1 - RF8 & RFC	This pin is DC coupled and matched to 50 Ohms. Blocking capacitors are required.	
8	Vdd	Supply Voltage +5 Vdc ±10%	
9	CTL C	See truth table and control voltage table.	
10	CTL B		
11	CTL A		