



GaAs MMIC SUB-HARMONIC SMT MIXER, 21 - 31 GHz

Typical Applications

The HMC264LC3B is ideal for:

- Point-to-Point Radios
- Point-to-Multi-Point Radios & VSAT
- Test Equipment & Sensors
- Military End-Use

Features

- Integrated LO Amplifier: -4 to +4 dBm Input
- Sub-Harmonically Pumped (x2) LO
- High 2LO/RF Isolation: 30 dB
- DC - 6 GHz Wideband IF
- 12 Lead 3x3mm SMT Package: 9mm²

Functional Diagram

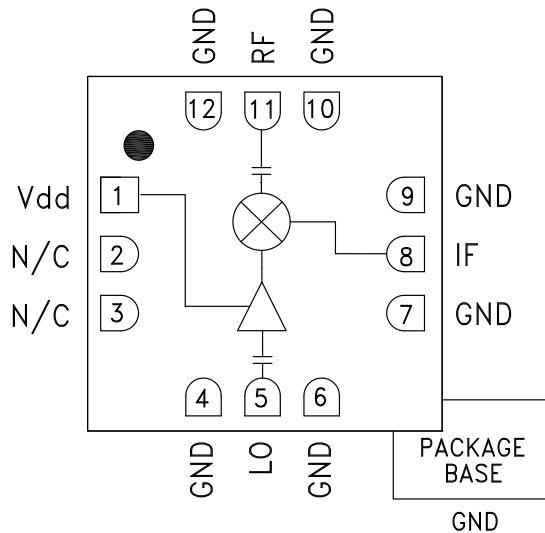

General Description

The HMC264LC3B is a 21 - 31 GHz Sub-harmonically Pumped (x2) MMIC Mixer with an integrated LO amplifier in a leadless "Pb Free" SMT package. The 2LO to RF isolation is excellent at 30 dB, eliminating the need for additional filtering. The LO amplifier is a single bias (+3V to +4V) design with only -4 to +4 dBm drive requirement. The RF and LO ports are DC blocked and matched to 50 Ohms for ease of use while the IF covers DC to 6 GHz. The HMC264LC3B eliminates the need for wire bonding, allowing use of surface mount manufacturing techniques.

Electrical Specifications, $T_A = +25\text{ }^\circ\text{C}$, As a Function of LO Drive & Vdd

Parameter	IF = 1 GHz LO = -4 dBm & Vdd = +4V			IF = 1 GHz LO = -4 dBm & Vdd = +3V			Units
	Min.	Typ.	Max.	Min.	Typ.	Max.	
Frequency Range, RF	21 - 31			22 - 31			GHz
Frequency Range, LO	10.5 - 15.5			11 - 15.5			GHz
Frequency Range, IF	DC - 6			DC - 6			GHz
Conversion Loss		9	12		9	12	dB
Noise Figure (SSB)		9	12		9	12	dB
2LO to RF Isolation	20	30		18	30		dB
2LO to IF Isolation	25	40		25	40		dB
IP3 (Input)		12			10		dBm
1 dB Compression (Input)		+3			+1		dBm
Supply Current (I _{dd})		28			25		mA

*Unless otherwise noted, all measurements performed as downconverter, IF = 1 GHz.



GaAs MMIC SUB-HARMONIC SMT MIXER, 21 - 31 GHz

Conversion Gain vs. Temperature @ LO = -4 dBm, Vdd = +4V

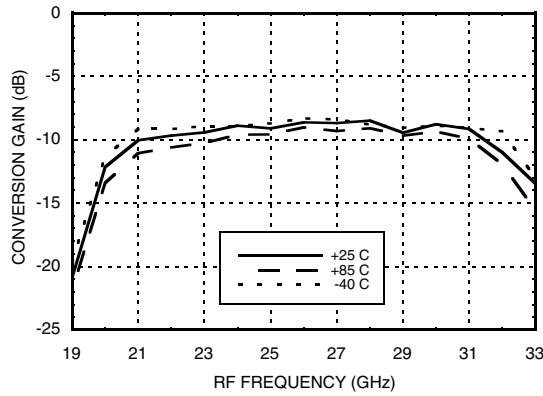

Conversion Gain vs. Temperature @ LO = -4 dBm, Vdd = +3V

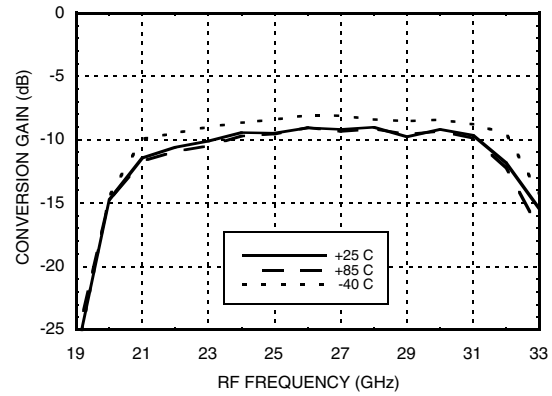

Conversion Gain vs. LO Drive @ Vdd = +4V

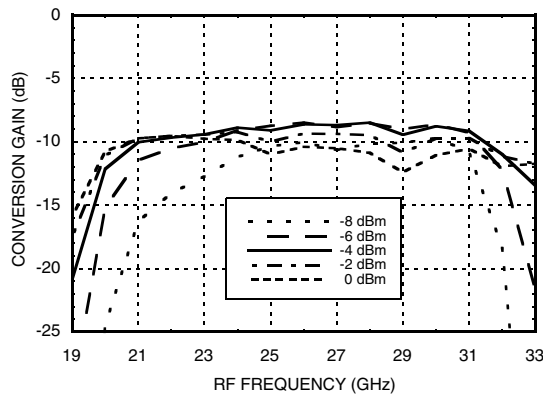

Conversion Gain vs. LO Drive @ Vdd = +3V

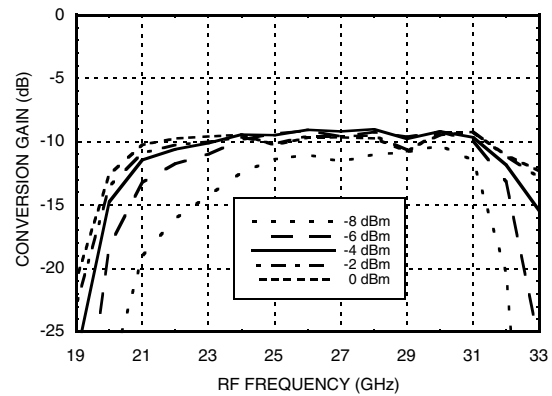

Isolation @ LO = -4 dBm, Vdd = +4V

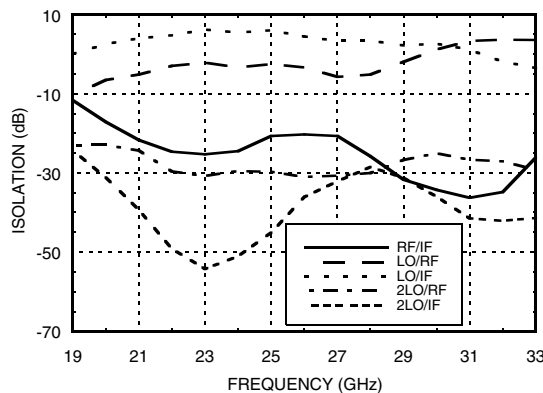

Isolation @ LO = -4 dBm, Vdd = +3V

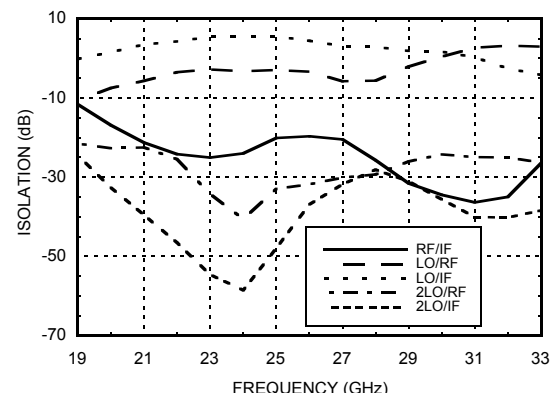



GaAs MMIC SUB-HARMONIC SMT MIXER, 21 - 31 GHz

Input IP3 vs. LO Drive @ Vdd = +4V *

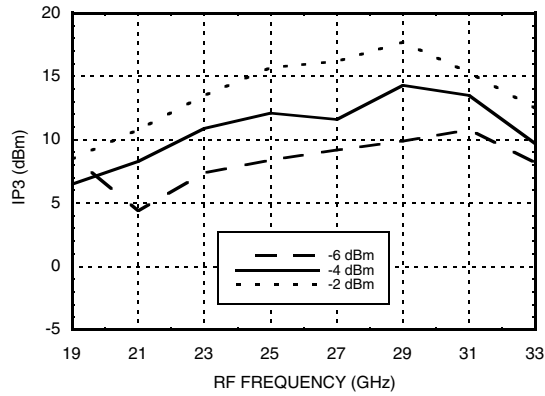

Input IP3 vs. LO Drive @ Vdd = +3V *

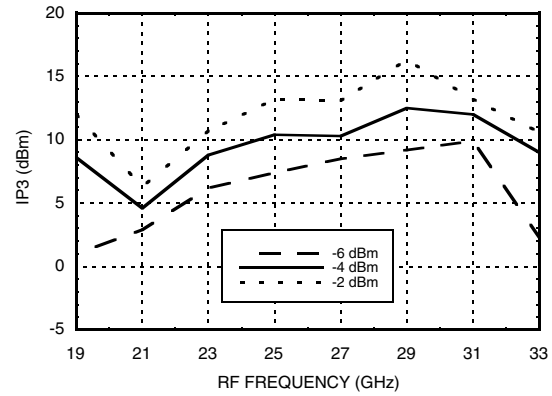

Input IP2 vs. LO Drive @ Vdd = +4V *

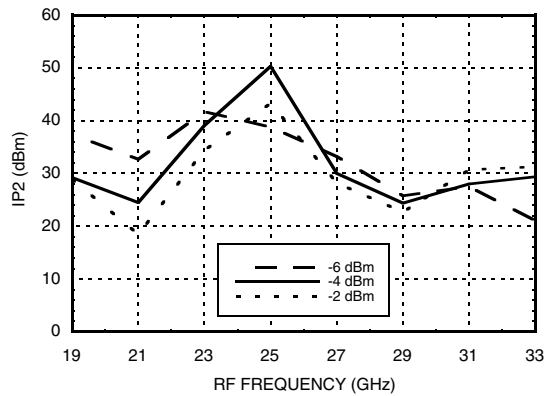

Input IP2 vs. LO Drive @ Vdd = +3V *

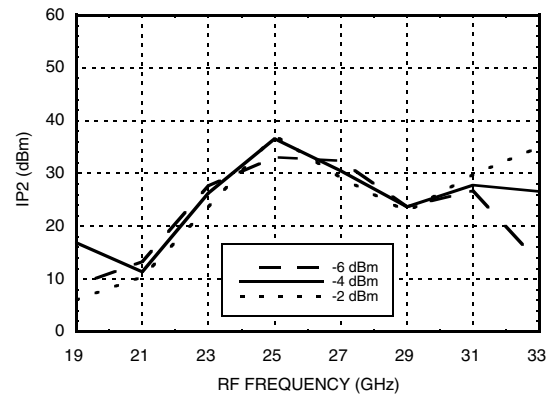

Input P1dB vs. Temperature @ LO = -4 dBm, Vdd = +4V

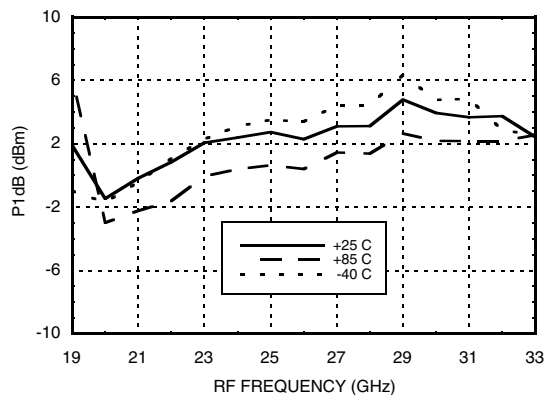

Input P1dB vs. Temperature @ LO = -4 dBm, Vdd = +3V

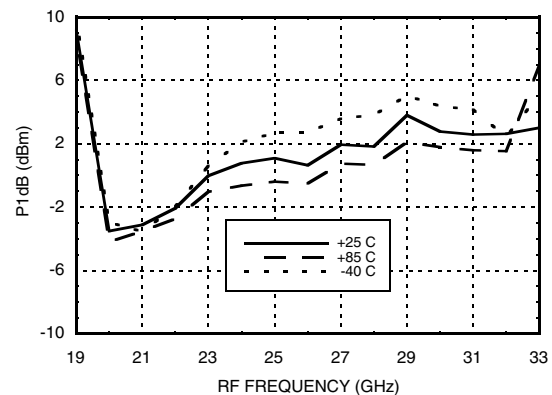

* Two-tone input power = -10 dBm each tone, 1 MHz spacing.

Information furnished by Analog Devices is believed to be accurate and reliable. However, no responsibility is assumed by Analog Devices for its use, nor for any infringements of patents or other rights of third parties that may result from its use. Specifications subject to change without notice. No license is granted by implication or otherwise under any patent or patent rights of Analog Devices. Trademarks and registered trademarks are the property of their respective owners.

For price, delivery, and to place orders: Analog Devices, Inc., One Technology Way, P.O. Box 9106, Norwood, MA 02062-9106 Phone: 781-329-4700 • Order online at www.analog.com Application Support: Phone: 1-800-ANALOG-D



GaAs MMIC SUB-HARMONIC SMT MIXER, 21 - 31 GHz

**Upconverter Performance
Conversion Gain @ LO = -4 dBm**

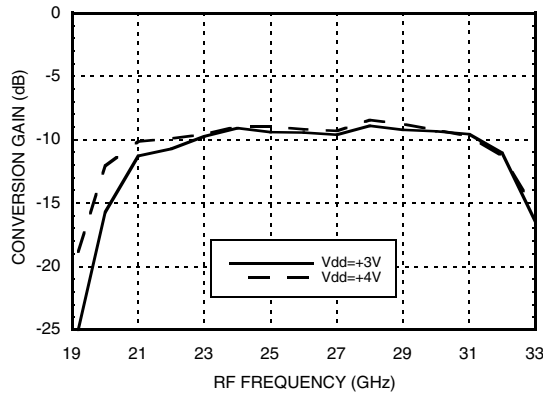

IF Bandwidth @ LO = -4 dBm

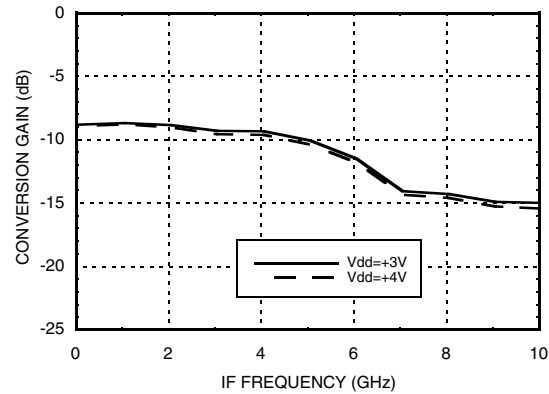

RF & LO Return Loss @ LO = -4 dBm

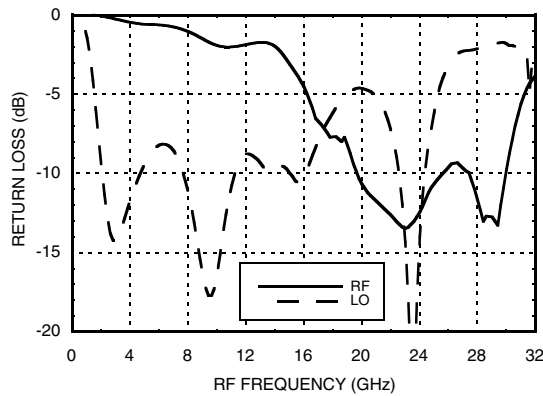

IF Return Loss @ LO = -4 dBm

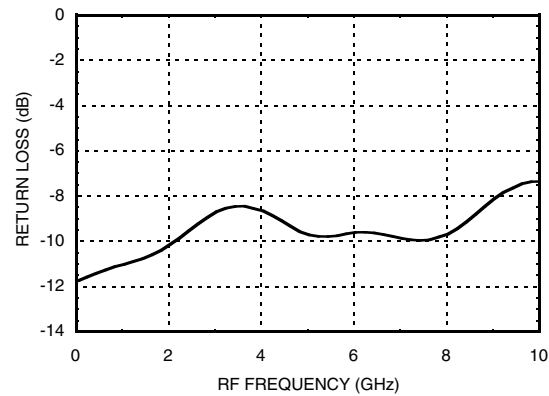

**MxN Spurious Outputs
@ LO = -4 dBm, Vdd = +4V**

mRF	nLO					
	±5	±4	±3	±2	±1	0
-2	30					
-1	60	39	31			
0			17	14	-17	
1				X	35	25
2		46	42	64	64	
3	82	80	82			

RF = 30 GHz @ -10 dBm
LO = 13.5 GHz @ -4 dBm
All values in dBc below IF power level.



GaAs MMIC SUB-HARMONIC SMT MIXER, 21 - 31 GHz

Absolute Maximum Ratings

RF / IF Input (Vdd = +5V)	+13 dBm
LO Drive (Vdd = +5V)	+13 dBm
Vdd	5.5V
Channel Temperature	175 °C
Continuous P _{diss} (Ta = 85 °C) (derate 2.52 mW/°C above 85 °C)	227 mW
Thermal Resistance (junction to ground paddle)	397 °C/W
Storage Temperature	-65 to +150 °C
Operating Temperature	-40 to +85 °C



ELECTROSTATIC SENSITIVE DEVICE
OBSERVE HANDLING PRECAUTIONS

Outline Drawing

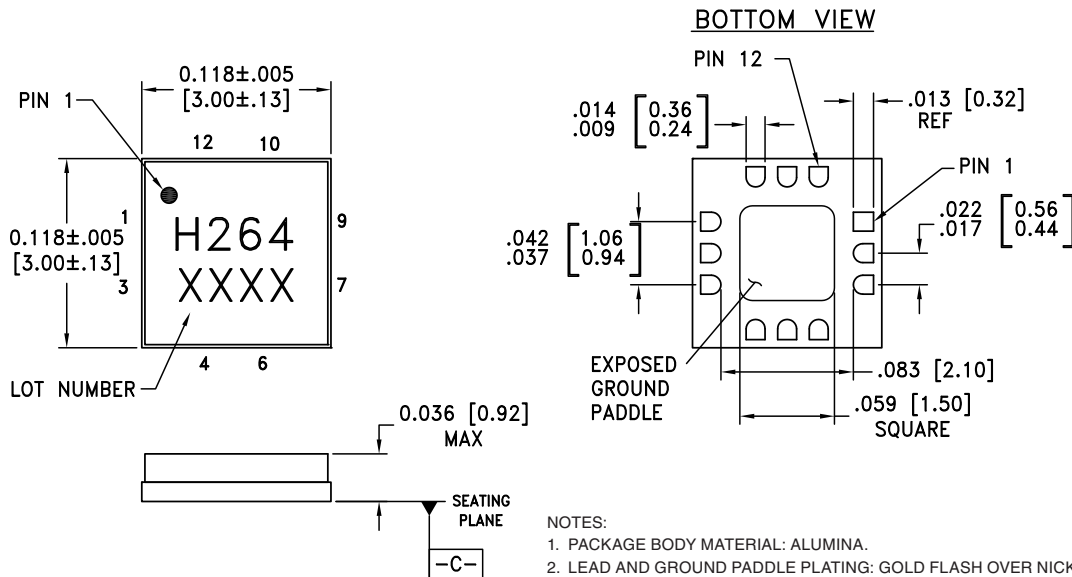

- NOTES:
1. PACKAGE BODY MATERIAL: ALUMINA.
 2. LEAD AND GROUND PADDLE PLATING: GOLD FLASH OVER NICKEL.
 3. DIMENSIONS ARE IN INCHES (MILLIMETERS).
 4. LEAD SPACING TOLERANCE IS NON-CUMULATIVE.
 5. CHARACTERS TO BE HELVETICA MEDIUM, .025 HIGH, BLACK INK, OR LASER MARK LOCATED APPROX. AS SHOWN.
 6. PACKAGE WARP SHALL NOT EXCEED 0.05MM DATUM $\overline{-C-}$
 7. ALL GROUND LEADS AND GROUND PADDLE MUST BE SOLDERED TO PCB RF GROUND.

Package Information

Part Number	Package Body Material	Lead Finish	MSL Rating	Package Marking ^[2]
HMC264LC3B	Alumina, White	Gold over Nickel	MSL3 ^[1]	H264 XXXX

[1] Max peak reflow temperature of 260 °C

[2] 4-Digit lot number XXXX



GaAs MMIC SUB-HARMONIC SMT MIXER, 21 - 31 GHz

Pin Descriptions

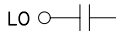
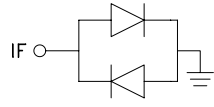
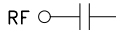
Pin Number	Function	Description	Interface Schematic
1	Vdd	Power supply for the LO Amplifier. External RF bypass capacitors are required as close to the package as possible.	
2, 3	N/C	No connection required. These pins may be connected to RF/DC ground without affecting performance.	
4, 6, 7, 9, 10, 12	GND	Package bottom must also be connected to RF/DC ground.	
5	LO	LO Port. This pin is AC coupled and matched to 50 Ohms from 10.5 - 15.5 GHz.	
8	IF	IF Port. This pin is DC coupled and should be DC blocked externally using a series capacitor whose value has been chosen to pass the necessary IF frequency range. Any applied DC voltage to this pin will result in die non-function and possible die failure.	
11	RF	RF Port. This pin is AC coupled and matched to 50 Ohms from 21 - 31 GHz.	



**GaAs MMIC SUB-HARMONIC
SMT MIXER, 21 - 31 GHz**

Evaluation PCB

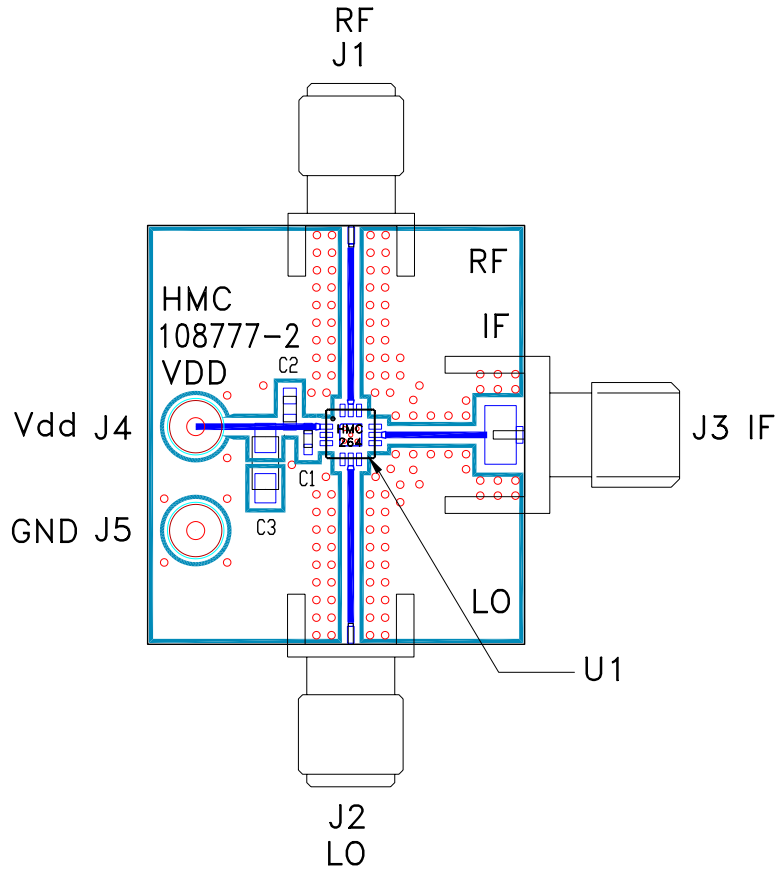

List of Materials for Evaluation PCB 108779 [1]

Item	Description
J1 - J3	PCB Mount SMA Connector
J4, J5	DC Pin
C1	100 pF Capacitor, 0402 Pkg.
C2	1000 pF Capacitor, 0603 Pkg
C3	2.2 μF Capacitor, Tantalum
U1	HMC264LC3B Mixer
PCB [2]	108777 Evaluation PCB

[1] Reference this number when ordering complete evaluation PCB

[2] Circuit Board Material: Rogers 4350

The circuit board used in this application should use RF circuit design techniques. Signal lines should have 50 Ohm impedance while the package ground leads and exposed paddle should be connected directly to the ground plane similar to that shown. A sufficient number of via holes should be used to connect the top and bottom ground planes. The evaluation board should be mounted to an appropriate heat sink. The evaluation circuit board shown is available from Hittite upon request.