



## SMT GaAs HBT MMIC DIVIDE-BY-2, 0.01 - 13 GHz

### Typical Applications

Prescaler for 10 MHz to 13 GHz PLL Applications:

- Point-to-Point / Multi-Point Radios
- VSAT Radios
- Fiber Optic
- Test Equipment
- Space & Military

### Features

- Ultra Low SSB Phase Noise: -148 dBc/Hz
- Wide Bandwidth
- Output Power: 3 dBm
- Single DC Supply: +5V
- 8 Lead Hermetic SMT Package

### Functional Diagram

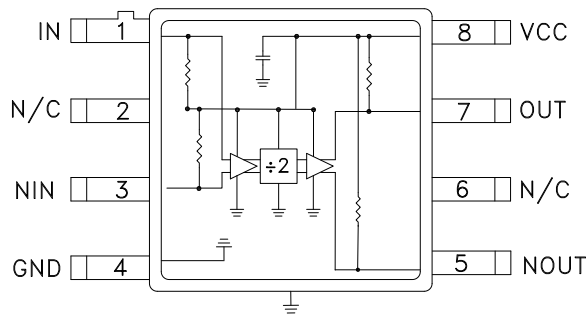

### General Description

The HMC361G8 is a low noise N=2 static divider in an 8 lead glass/metal surface mount (hermetic) package. This device operates from 10 MHz (with a square wave input) to 13 GHz input frequency with a single +5V DC supply. The low additive SSB phase noise of -148 dBc/Hz at 100 kHz offset helps the user maintain good system noise performance.

### Electrical Specifications, $T_A = +25^\circ\text{C}$ , 50 Ohm System, $V_{CC} = 5V$

Parameter	Conditions	Min.	Typ.	Max.	Units
Maximum Input Frequency	Sine Wave or Square Wave input	13			GHz
Minimum Input Frequency	Sine Wave or Square Wave Input. {1}			0.20	GHz
Minimum Input Frequency	Square Wave {1} {2}			0.01	GHz
Input Power Range	$F_{in} = 0.01$ to 0.20 GHz (square wave)	-10		10	dBm
	$F_{in} = 0.20$ to 0.5 GHz (sine)	0		10	dBm
	$F_{in} = 0.5$ to 1 GHz (sine)	-10		10	dBm
	$F_{in} = 1$ to 8 GHz (sine)	-15		10	dBm
	$F_{in} = 8$ to 13 GHz (sine)	-15		2	dBm
Output Power	$F_{in} = 0.20$ GHz		4.5		dBm
	$F_{in} = 6$ GHz		3.6		dBm
	$F_{in} = 9$ GHz		1.6		dBm
	$F_{in} = 13$ GHz		-2.5		dBm
Reverse Leakage	Both RF Outputs Terminated		40		dB
SSB Phase Noise (100 kHz offset)	$P_{in} = 0$ dBm, $F_{in} = 6$ GHz (sine)		-148		dBc/Hz
Output Transition Time	$P_{in} = 0$ dBm, $F_{out} = 882$ MHz		100		ps
Supply Current ( $I_{CC}$ ) ( $V_{CC} = +5V$ )			84		mA

1. Divider will operate down to 0.01 GHz with a square-wave input signal.

2. Square wave input waveform is recommended for operation below 200 MHz. Recommended transition times are < 100 ps.



**SMT GaAs HBT MMIC  
DIVIDE-BY-2, 0.01 - 13 GHz**

**Input Sensitivity Window,  $T = 25\text{ }^{\circ}\text{C}$**

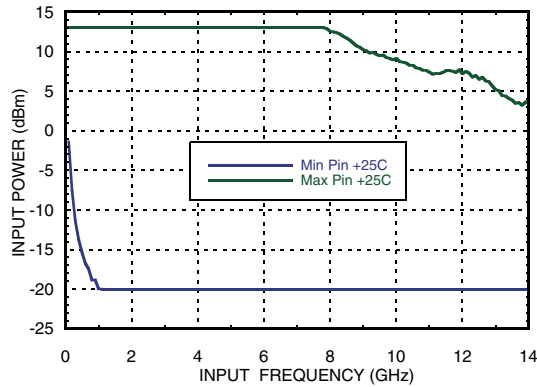

**Input Sensitivity Window vs. Temperature**

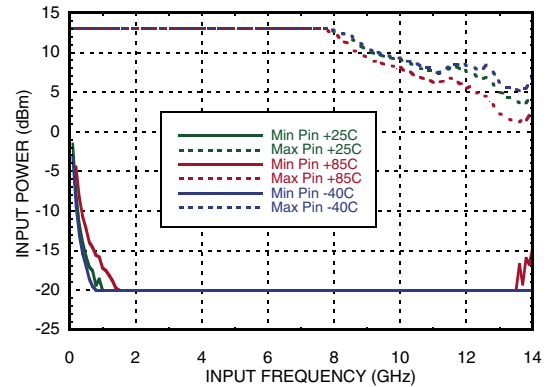

**Output Power vs. Temperature**

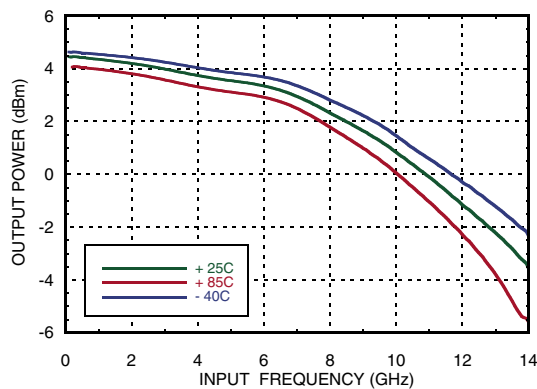

**SSB Phase Noise Performance vs. Temperature,  $P_{in} = 0\text{ dBm}$ ,  $F_{in} = 6\text{ GHz}$**

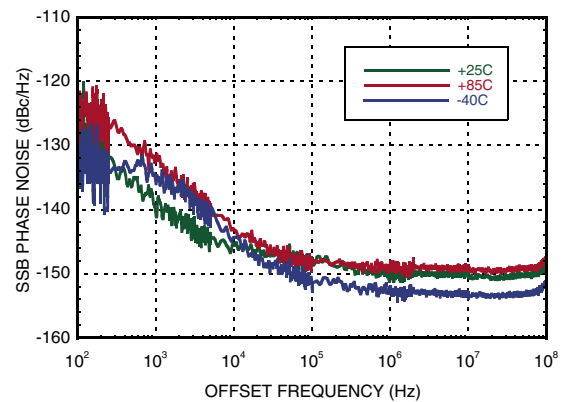

**Output Harmonic Content,  $P_{in} = 0\text{ dBm}$ ,  $T = 25\text{ }^{\circ}\text{C}$**

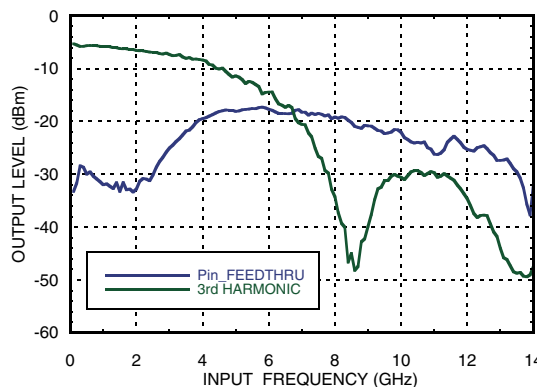

**Reverse Leakage,  $P_{in} = 0\text{ dBm}$ ,  $T = 25\text{ }^{\circ}\text{C}$**

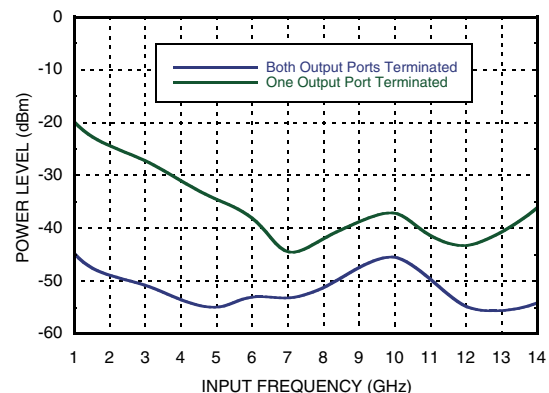

Information furnished by Analog Devices is believed to be accurate and reliable. However, no responsibility is assumed by Analog Devices for its use, nor for any infringements of patents or other rights of third parties that may result from its use. Specifications subject to change without notice. No license is granted by implication or otherwise under any patent or patent rights of Analog Devices. Trademarks and registered trademarks are the property of their respective owners.

For price, delivery, and to place orders: Analog Devices, Inc., One Technology Way, P.O. Box 9106, Norwood, MA 02062-9106 Phone: 781-329-4700 • Order online at [www.analog.com](http://www.analog.com) Application Support: Phone: 1-800-ANALOG-D



## SMT GaAs HBT MMIC DIVIDE-BY-2, 0.01 - 13 GHz

**Output Voltage Waveform,**  
*Pin= 0 dBm, Fout= 882 MHz, T= 25 °C*

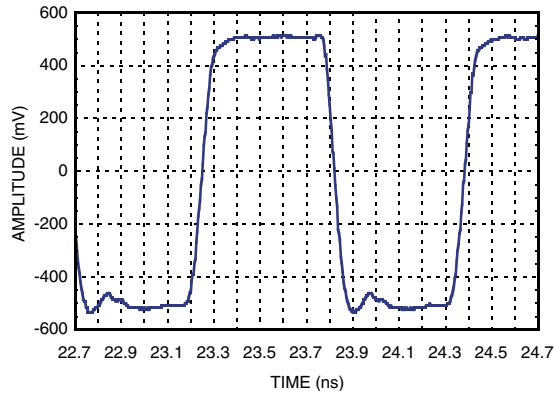

### Absolute Maximum Ratings

RF Input (Vcc = +5V)	+13 dBm
Vcc	+5.5V
Storage Temperature	-65 to +150 °C
ESD Sensitivity (HBM)	100V

### Reliability Information

Junction Temperature to Maintain 1 Million Hour MTTF	135 °C
Nominal Junction Temperature (T = 85 °C and Pin = + 10 dBm)	126 °C
Thermal Resistance (Rth) (Junction to GND Paddle, 5V Supply)	96.9 °C/W
Operating Temperature	-40 to +85 °C

**Typical Supply Current vs. Vcc, T= 25 °C**

Vcc (V)	Icc (mA)
4.75	76
5.0	84
5.25	90

Note: Divider will operate over full voltage range shown above



**ELECTROSTATIC SENSITIVE DEVICE  
OBSERVE HANDLING PRECAUTIONS**

### Outline Drawing

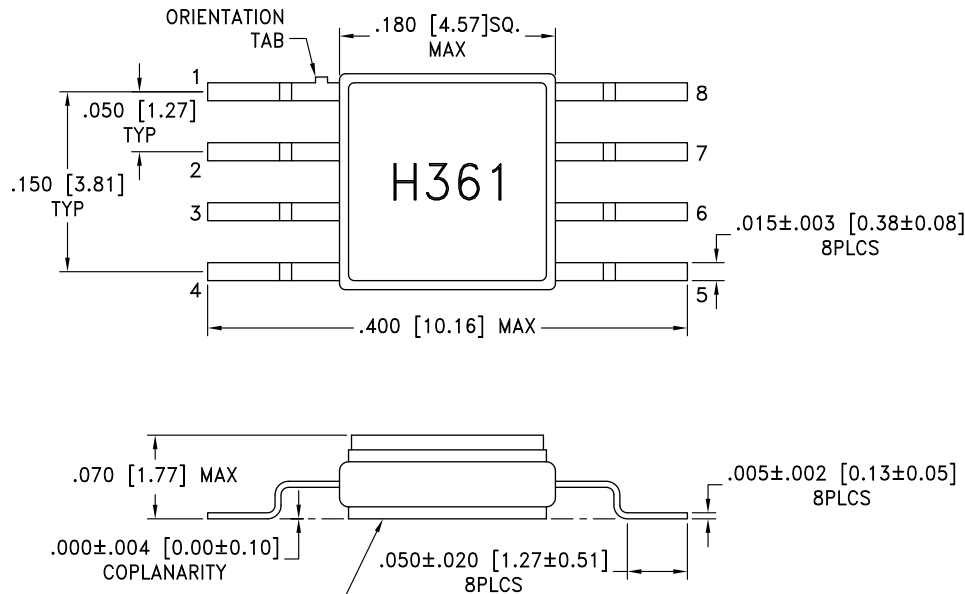

**NOTES:**

- PACKAGE MATERIAL: ALUMINA LOADED BOROSILICATE GLASS.
- LEAD, BASE, COVER MATERIAL: KOVAR™ (#7052 CORNING).
- PLATING: ELECTROLYTIC GOLD 50 MICROINCHES MIN., OVER ELECTROLYTIC NICKEL 50 MICROINCHES MIN.
- DIMENSIONS ARE IN INCHES [MILLIMETERS].
- TOLERANCES: ±.005 [0.13] UNLESS OTHERWISE SPECIFIED.
- ALL GROUND LEADS AND GROUND PADDLE MUST BE SOLDERED TO PCB RF GROUND.



Information furnished by Analog Devices is believed to be accurate and reliable. However, no responsibility is assumed by Analog Devices for its use, nor for any infringements of patents or other rights of third parties that may result from its use. Specifications subject to change without notice. No license is granted by implication or otherwise under any patent or patent rights of Analog Devices. Trademarks and registered trademarks are the property of their respective owners.

For price, delivery, and to place orders: Analog Devices, Inc., One Technology Way, P.O. Box 9106, Norwood, MA 02062-9106 Phone: 781-329-4700 • Order online at [www.analog.com](http://www.analog.com) Application Support: Phone: 1-800-ANALOG-D

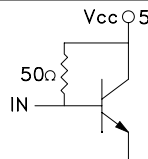
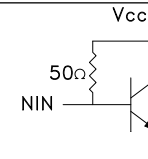

## SMT GaAs HBT MMIC DIVIDE-BY-2, 0.01 - 13 GHz

### Pin Description

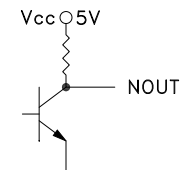
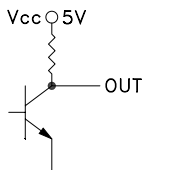
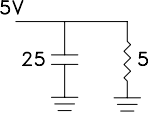
Pin Number	Function	Description	Interface Schematic
1	IN	RF Input, must be DC blocked.	
2, 6	N/C	These pins are not connected internally; however, all data shown herein was measured with the pins connected to RF/DC ground.	
3	NIN	RF Input 180° out of phase with pin 1 for differential operation. Must be DC blocked. AC ground for single ended operation.	
4	GND	Pin and exposed paddle must be connected to RF/DC ground.	
5	NOUT	Divided output 180° out of phase with pin 7, must be DC blocked.	
7	OUT	Divided Output, must be DC blocked.	
8	Vcc	Supply voltage 5V ± 0.25V.	



**SMT GaAs HBT MMIC  
DIVIDE-BY-2, 0.01 - 13 GHz**

**Evaluation PCB**

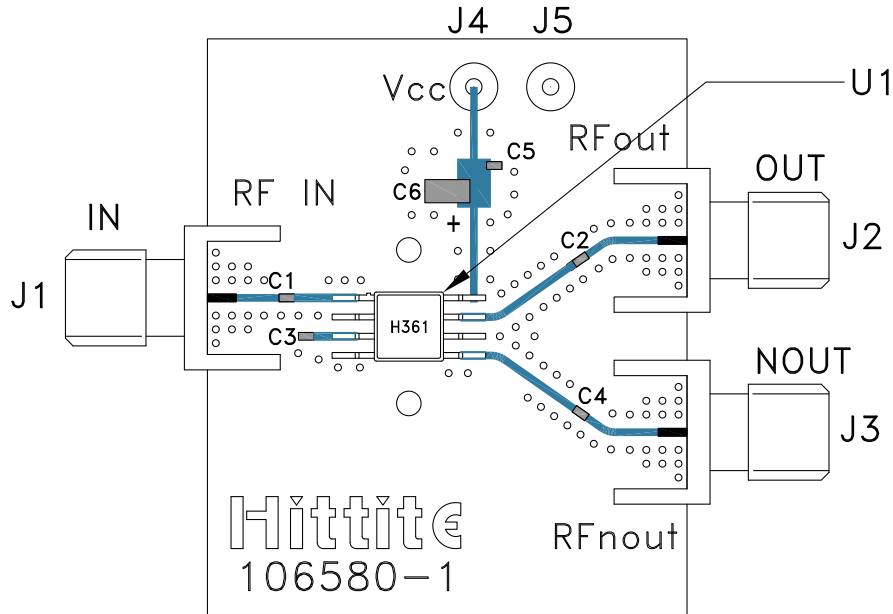

**List of Materials for Evaluation PCB EVAL01-HMC361G8 [1]**

Item	Description
J1 - J3	Connector, SMA, Female
J4, J5	DC Pins
C1 - C4	ATC530L, Broadband Capacitor, 0402 Pkg.
C5	1000 pF Capacitor, 0603 Pkg.
C6	10 uF Tantalum Capacitor, 1206 Pkg.
U1	HMC361G8
PCB [2]	106580 Evaluation PCB

[1] Reference this number when ordering complete evaluation PCB

[2] Circuit Board Material: Rogers 4350

The circuit board used in the application should use RF circuit design techniques. Signal lines should have 50 Ohm impedance while the package ground leads and backside ground slug should be connected directly to the ground plane similar to that shown. A sufficient number of via holes should be used to connect the top and bottom ground planes. The evaluation circuit board shown is available from Hittite upon request. This evaluation board is designed for single ended input testing. J2 and J3 provide differential output signals.