



GaAs pHEMT MMIC MEDIUM POWER AMPLIFIER, 6.5 - 13.5 GHz

Typical Applications

The HMC441LP3 / HMC441LP3E is a medium PA for:

- Point-to-Point Radios
- Point-to-Multi-Point Radios
- VSAT
- LO Driver for HMC Mixers
- Military EW & ECM

Features

- Gain: 14 dB
- Saturated Power: +20 dBm @ 20% PAE
- Single Supply Voltage: +5V w/ Optional Gate Bias
- 50 Ohm Matched Input/Output
- 16 Lead 3x3mm SMT Package: 9mm²

Functional Diagram

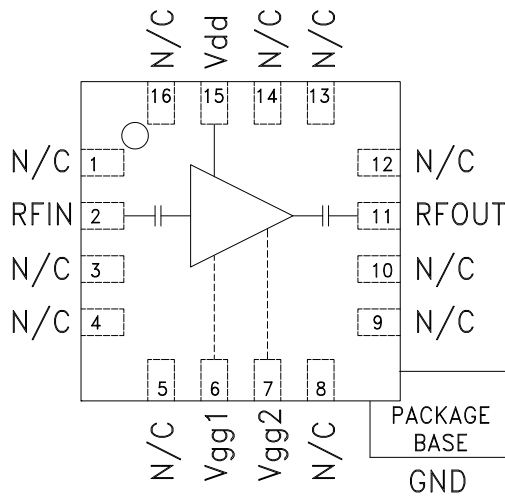

TOP VIEW

Vgg1, Vgg2: Optional Gate Bias

General Description

The HMC441LP3 & HMC441LP3E are broadband GaAs PHEMT MMIC Medium Power Amplifiers which operate between 6.5 and 13.5 GHz. The leadless plastic QFN surface mount packaged amplifier provides 14 dB of gain, +20 dBm saturated power at 20% PAE from a +5V supply voltage. An optional gate bias is provided to allow adjustment of gain, RF output power, and DC power dissipation. This 50 Ohm matched amplifier does not require any external components making it an ideal linear gain block or driver for HMC SMT mixers.

Electrical Specifications, $T_A = +25^\circ\text{C}$, $V_{dd} = 5\text{V}$, $V_{gg1} = V_{gg2} = \text{Open}$

Parameter	Min.	Typ.	Max.	Min.	Typ.	Max.	Min.	Typ.	Max.	Units
Frequency Range	6.5 - 8.0			8.0 - 11.0			11.0 - 13.5			GHz
Gain	10	13		12	14		10	13		dB
Gain Variation Over Temperature		0.02	0.025		0.02	0.025		0.02	0.025	dB/°C
Input Return Loss		12			15			14		dB
Output Return Loss		12			15			13		dB
Output Power for 1 dB Compression (P1dB)	13	16		15	18		14	17		dBm
Saturated Output Power (Psat)		18.5			20			19.5		dBm
Output Third Order Intercept (IP3)	23	26		26	29		26	29		dBm
Noise Figure		5.0			4.5			4.75		dB
Supply Current (Idd)		90	115		90	115		90	115	mA



**GaAs pHEMT MMIC MEDIUM
POWER AMPLIFIER, 6.5 - 13.5 GHz**

Broadband Gain & Return Loss

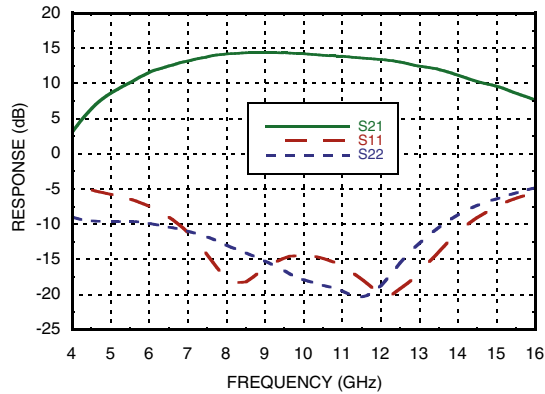

Gain vs. Temperature

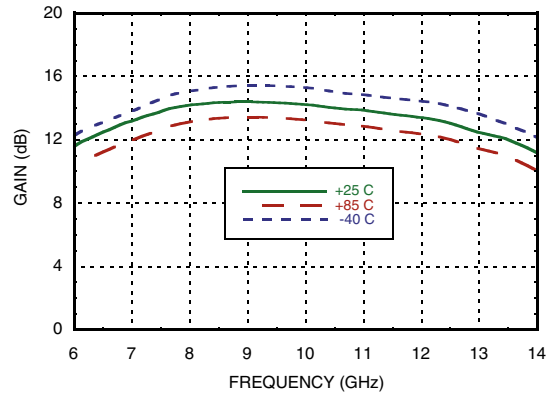

Input Return Loss vs. Temperature

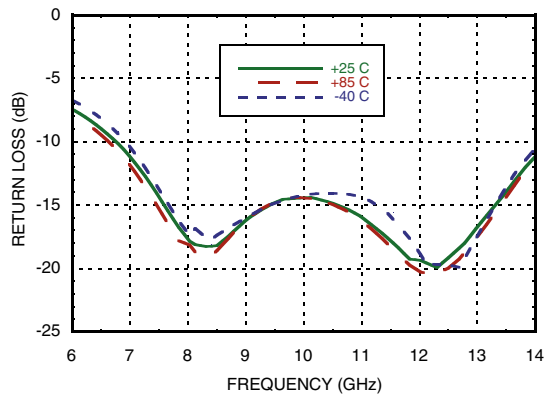

Output Return Loss vs. Temperature

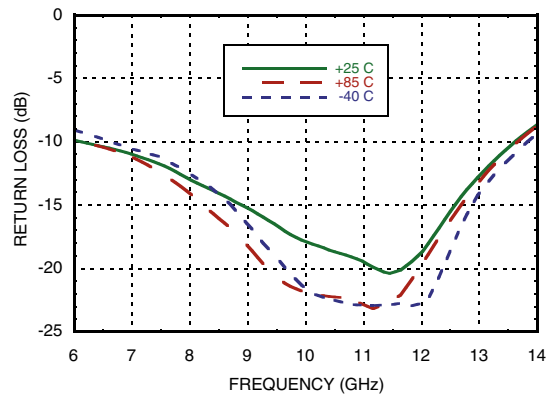

P1dB vs. Temperature

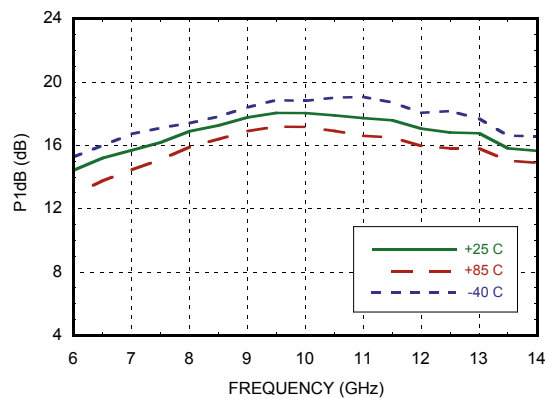

Psat vs. Temperature

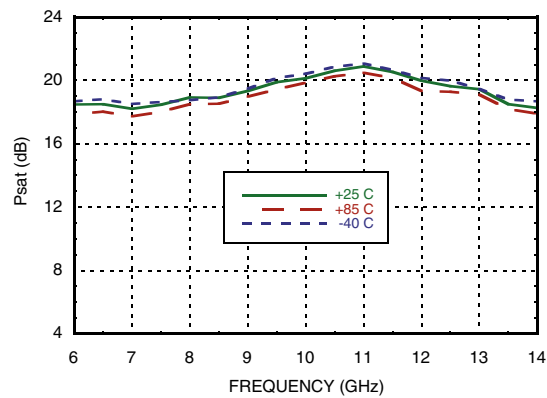

Information furnished by Analog Devices is believed to be accurate and reliable. However, no responsibility is assumed by Analog Devices for its use, nor for any infringements of patents or other rights of third parties that may result from its use. Specifications subject to change without notice. No license is granted by implication or otherwise under any patent or patent rights of Analog Devices. Trademarks and registered trademarks are the property of their respective owners.

For price, delivery, and to place orders: Analog Devices, Inc., One Technology Way, P.O. Box 9106, Norwood, MA 02062-9106 Phone: 781-329-4700 • Order online at www.analog.com Application Support: Phone: 1-800-ANALOG-D



Power Compression @ 10 GHz

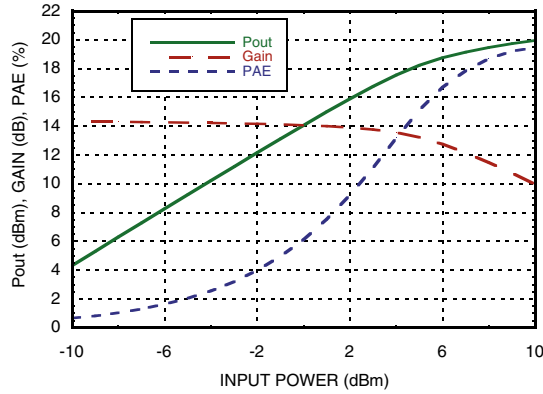

Output IP3 vs. Temperature

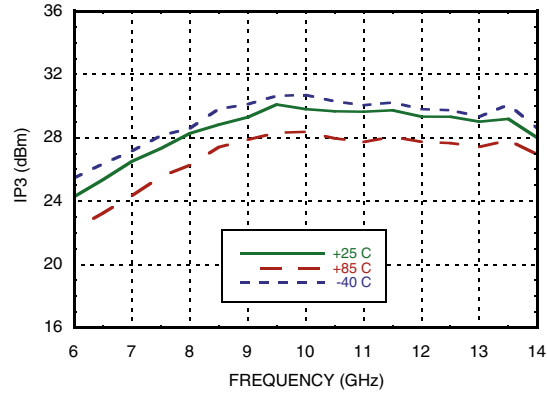

Gain, Power & Output IP3 vs. Supply Voltage @ 10 GHz

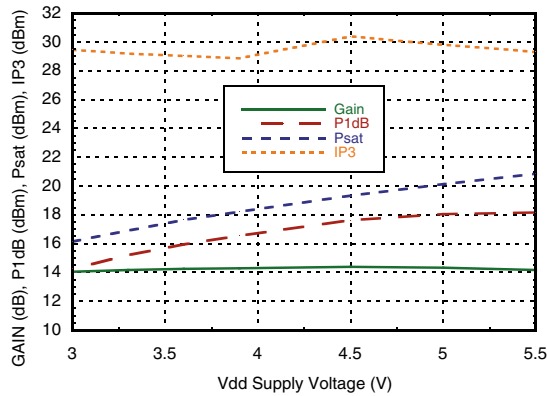

Gain, Power & Idd vs. Gate Voltage @ 10 GHz

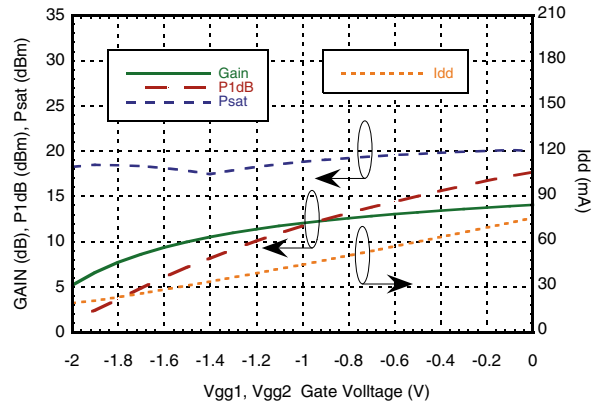

Noise Figure vs. Temperature

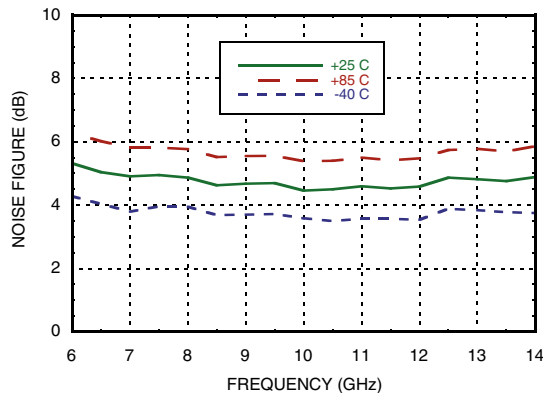

Reverse Isolation vs. Temperature

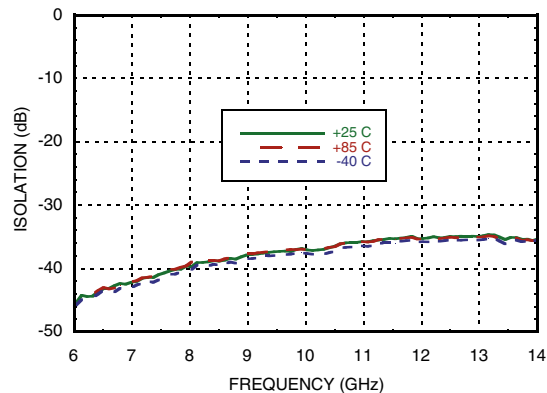

Information furnished by Analog Devices is believed to be accurate and reliable. However, no responsibility is assumed by Analog Devices for its use, nor for any infringements of patents or other rights of third parties that may result from its use. Specifications subject to change without notice. No license is granted by implication or otherwise under any patent or patent rights of Analog Devices. Trademarks and registered trademarks are the property of their respective owners.

For price, delivery, and to place orders: Analog Devices, Inc., One Technology Way, P.O. Box 9106, Norwood, MA 02062-9106 Phone: 781-329-4700 • Order online at www.analog.com Application Support: Phone: 1-800-ANALOG-D



GaAs pHEMT MMIC MEDIUM POWER AMPLIFIER, 6.5 - 13.5 GHz

Absolute Maximum Ratings

Drain Bias Voltage (Vdd)	+6 Vdc
Gate Bias Voltage (Vgg1,Vgg2)	-8 to 0 Vdc
RF Input Power (RFIN)(Vdd = +5 Vdc)	+15 dBm
Channel Temperature	175 °C
Continuous Pdiss (T = 85 °C) (derate 8.5 mW/°C above 85 °C)	0.76 W
Thermal Resistance (channel to ground paddle)	118.2 °C/W
Storage Temperature	-65 to +150 °C
Operating Temperature	-40 to +85 °C

Typical Supply Current vs. Vdd

Vdd (V)	Idd (mA)
+5.5	92
+5.0	90
+4.5	88
+3.3	83
+3.0	82

Note: Amplifier will operate over full voltage range shown above



ELECTROSTATIC SENSITIVE DEVICE
OBSERVE HANDLING PRECAUTIONS

Outline Drawing

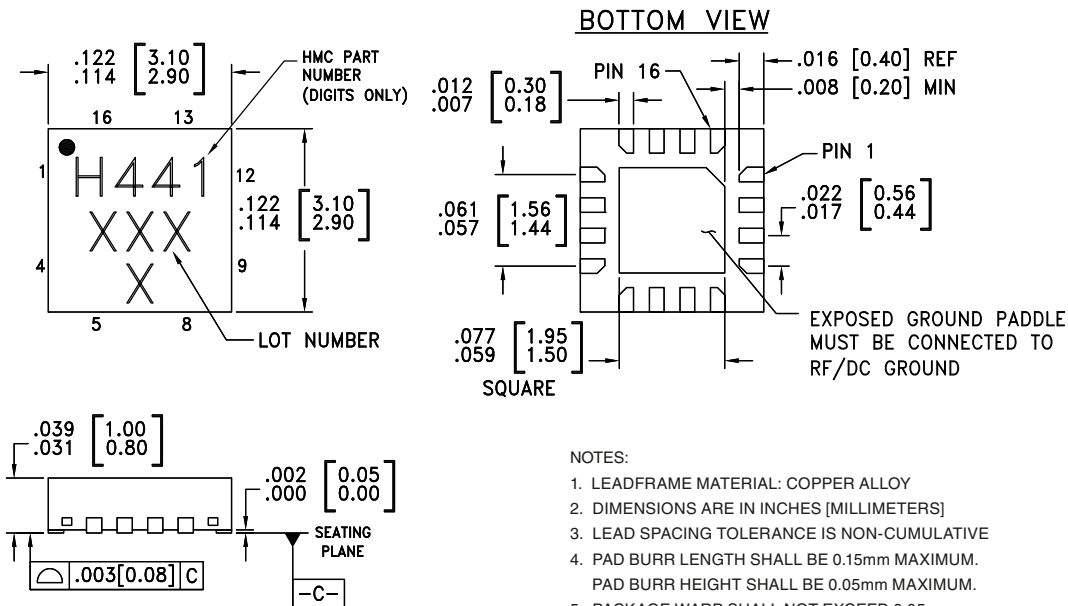

NOTES:

- LEADFRAME MATERIAL: COPPER ALLOY
- DIMENSIONS ARE IN INCHES [MILLIMETERS]
- LEAD SPACING TOLERANCE IS NON-CUMULATIVE
- PAD BURR LENGTH SHALL BE 0.15mm MAXIMUM.
PAD BURR HEIGHT SHALL BE 0.05mm MAXIMUM.
- PACKAGE WARP SHALL NOT EXCEED 0.05mm.
- ALL GROUND LEADS AND GROUND PADDLE MUST BE SOLDERED TO PCB RF GROUND.
- REFER TO HITTITE APPLICATION NOTE FOR SUGGESTED LAND PATTERN.

Package Information

Part Number	Package Body Material	Lead Finish	MSL Rating	Package Marking ^[3]
HMC441LP3	Low Stress Injection Molded Plastic	Sn/Pb Solder	MSL1 ^[1]	441 XXXX
HMC441LP3E	RoHS-compliant Low Stress Injection Molded Plastic	100% matte Sn	MSL1 ^[2]	441 XXXX

[1] Max peak reflow temperature of 235 °C

[2] Max peak reflow temperature of 260 °C

[3] 4-Digit lot number XXXX



GaAs pHEMT MMIC MEDIUM POWER AMPLIFIER, 6.5 - 13.5 GHz

Pin Descriptions

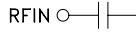
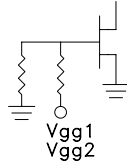
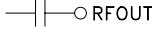
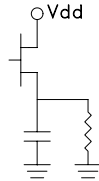
Pin Number	Function	Description	Interface Schematic
1, 3-5, 8-10, 12-14, 16	N/C	This pin may be connected to RF/DC ground.	
2	RFIN	This pin is AC coupled and matched to 50 Ohms.	RFIN 
6, 7	Vgg1, Vgg2	Optional gate control for amplifier. If left open, the amplifier will run at standard current. Negative voltage applied will reduce current.	
11	RFOUT	This pin is AC coupled and matched to 50 Ohms.	
15	Vdd	Power Supply Voltage for the amplifier. An external bypass capacitor of 100 pF is required.	
	GND	Package bottom must be connected to RF/DC ground.	