

Typical Applications

The HMC546MS8G(E) is ideal for:

- LNA Protection, WiMAX, WiBro
- Cellular/PCS/3G Infrastructure
- Private Mobile Radio and Public Safety Handsets
- Automotive Telematics

Features

- High Input P0.1dB: +40 dBm Tx
- Low Insertion Loss: 0.4 dB
- High IIP3: +65 dBm
- Positive Control: 0/+3V to 0/+8V
- Failsafe Operation: Tx "on" When Unpowered

Functional Diagram

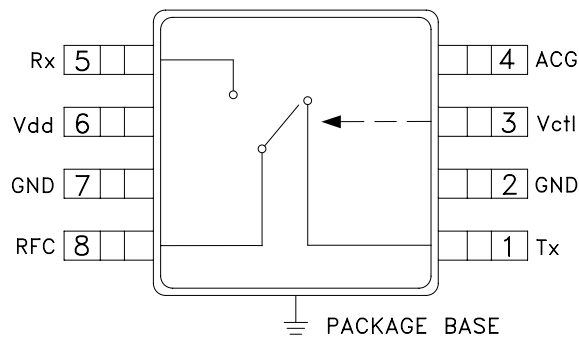

General Description

The HMC546MS8G(E) is a low-cost SPDT switch in 8-lead MSOP8G surface mount package for use in transmit-receive applications which require very low distortion at high signal power levels, up to 10 watts. The device can control signals from 200 - 2200 MHz* and is especially suited for cellular booster, PMR and automotive telematic applications. The design provides exceptional P0.1dB of +40 dBm and +65 dBm IIP3 on the Transmit (Tx) port. The failsafe topology allows the switch to provide a low loss path from RFC to Tx, when no DC power is available.

Electrical Specifications, $T_A = +25^\circ\text{C}$, $V_{dd} = 3\text{V}$, $V_{ctl} = 0/+3\text{Vdc}$, 50 Ohm System*

| Parameter | Min. | Typ. | Max. | Min. | Typ. | Max. | Min. | Typ. | Max. | Min. | Typ. | Max. | Units |
|---|---------------------------|------|------|-----------|------|------|-------------|------|------|-------------|------|------|-------|
| Frequency Range | 216 - 222 | | | 869 - 960 | | | 2010 - 2025 | | | 2110 - 2170 | | | MHz |
| Insertion Loss | Tx - RFC | 0.4 | 0.7 | | 0.4 | 0.7 | | 0.3 | 0.6 | | 0.4 | 0.7 | dB |
| | RFC - Rx | 0.4 | 0.7 | | 0.5 | 0.8 | | 0.5 | 0.8 | | 1.1 | 1.5 | dB |
| Isolation | Tx - RFC | 25 | 30 | | 20 | 24 | | 17 | 20 | | 8 | 12 | dB |
| | RFC - Rx | 33 | 40 | | 23 | 30 | | 25 | 30 | | 25 | 30 | dB |
| Return Loss | Tx - RFC | | 20 | | | 25 | | | 23 | | | 16 | dB |
| | RFC - Rx | | 20 | | | 25 | | | 20 | | | 13 | dB |
| Input Power for 0.1 dB Compression | Tx - RFC | 37 | 39 | | 37 | 39 | | 38 | >40 | | 38 | >40 | dBm |
| | RFC - Rx | 19 | 21 | | 19 | 21 | | 17.5 | 19.5 | | 17.5 | 19.5 | dBm |
| Input Power for 1 dB Compression | Tx - RFC | 43 | | | 43 | | | 43 | | | 43 | | dBm |
| | RFC - Rx | 22 | | | 22 | | | 22 | | | 22 | | dBm |
| Input Third Order Intercept (Two-tone input power = +19 dBm each tone) | Tx - RFC | | 60 | | | 66 | | | 67 | | | 67 | dBm |
| | Vctl = 0/+3V RFC - Rx | | 31 | | | 32 | | | 31 | | | 31 | dBm |
| | Tx - RFC | | 60 | | | 66 | | | 67 | | | 67 | dBm |
| | Vctl = 0/+5V RFC - Rx | | 57 | | | 48 | | | 37 | | | 43 | dBm |
| Switching Characteristics | tRISE, tFALL (10%/90% RF) | | 21 | | | 21 | | | 21 | | | 21 | ns |
| | tON, (50% CTL to 90% RF) | | 102 | | | 102 | | | 102 | | | 102 | ns |
| | tOFF (50% CTL to 10% RF) | | 36 | | | 36 | | | 36 | | | 36 | ns |

* Specifications and data reflect HMC546MS8G(E) measured using the respective application circuits for each designated frequency band found herein



Insertion Loss vs. Temperature, Tx with 220 MHz Tuning

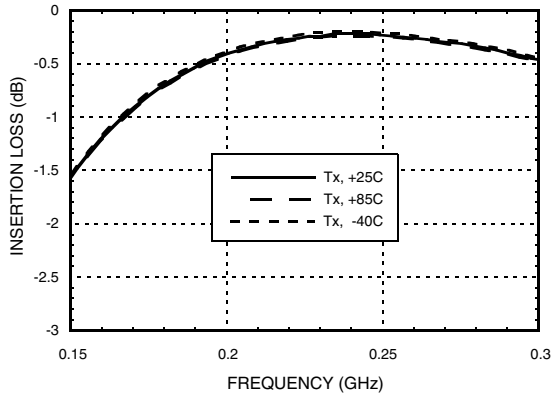

Insertion Loss vs. Temperature, Rx with 220 MHz Tuning

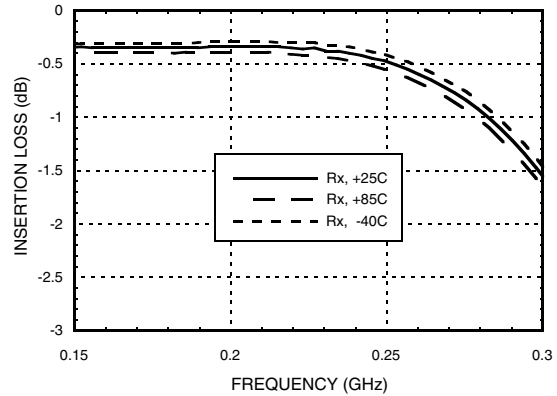

Isolation with 220 MHz Tuning

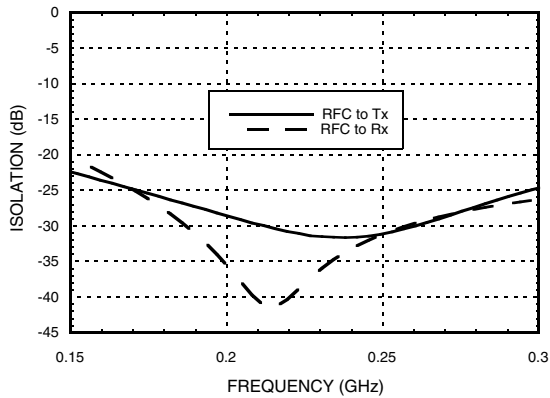

Return Loss with 220 MHz Tuning

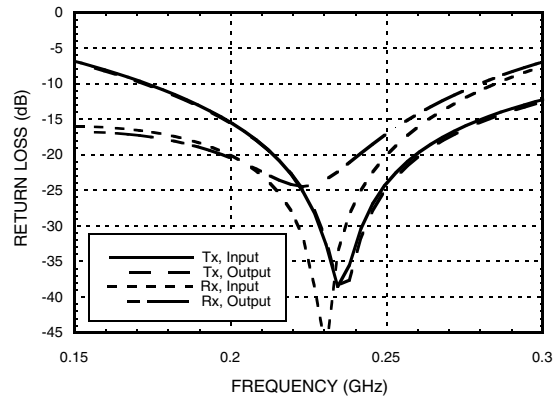

Input IP3 vs. Voltage with 220 MHz Tuning

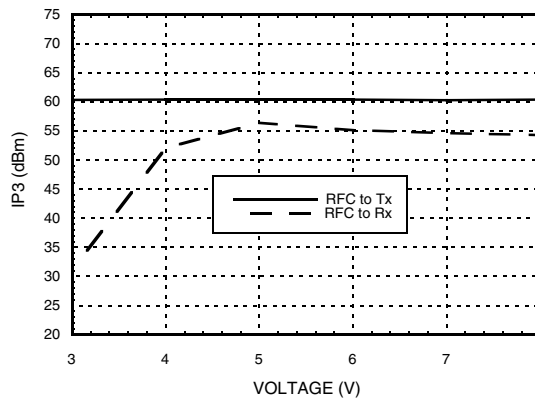



GaAs MMIC 20W FAILSAFE SWITCH
0.2 - 2.2 GHz

SWITCHES -SPDT T/R-SMT

Insertion Loss vs. Temperature, Tx with 457 MHz Tuning

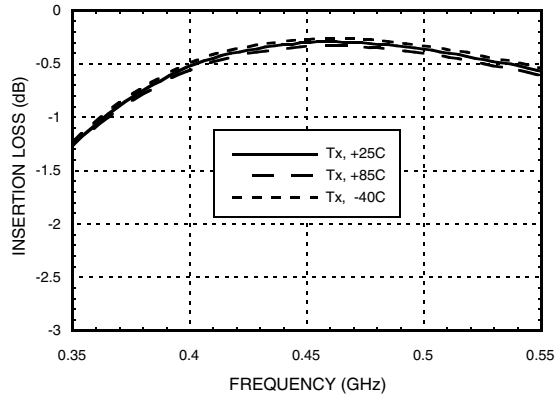

Insertion Loss vs. Temperature, Rx with 457 MHz Tuning

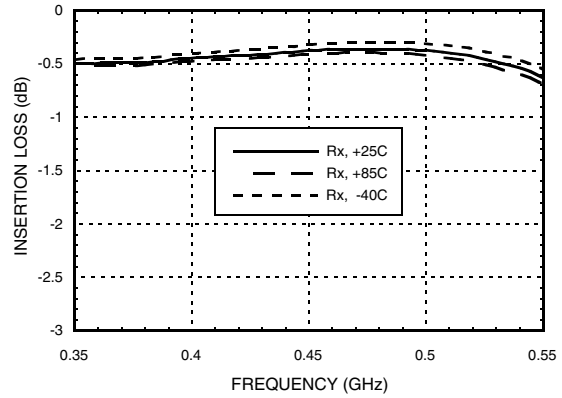

Isolation with 457 MHz Tuning

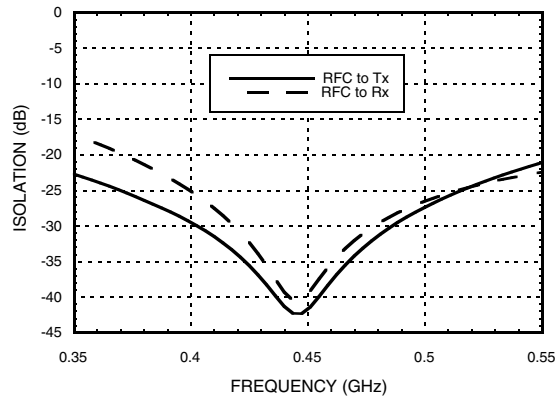

Return Loss with 457 MHz Tuning

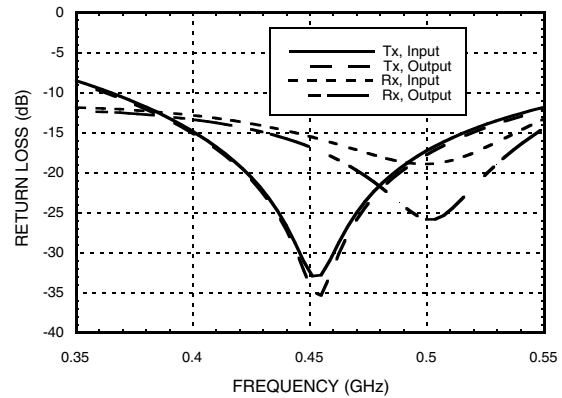

Input IP3 vs. Voltage with 457 MHz Tuning

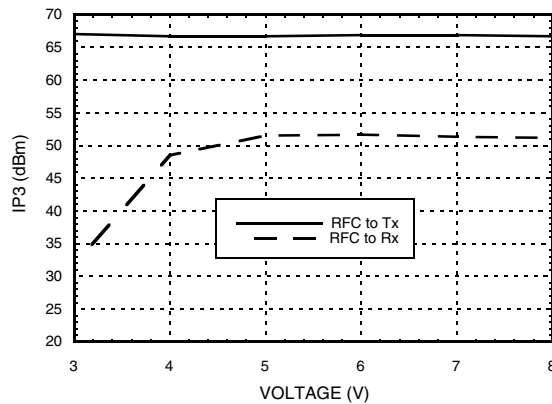



Insertion Loss vs. Temperature, Tx with 785 MHz Tuning

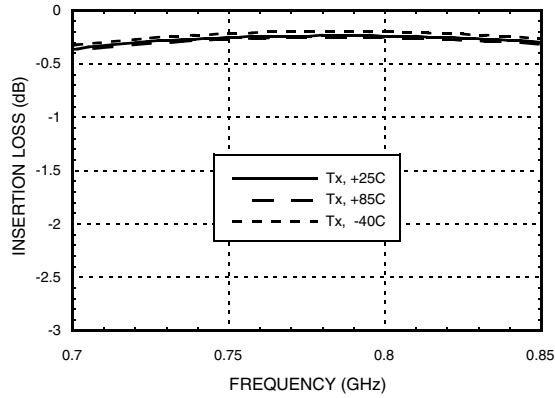

Insertion Loss vs. Temperature, Rx with 785 MHz Tuning

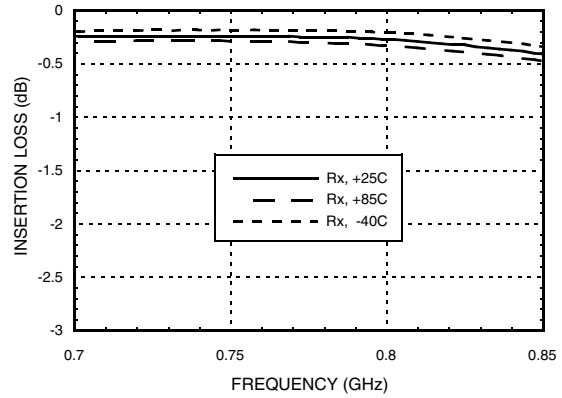

Isolation with 785 MHz Tuning

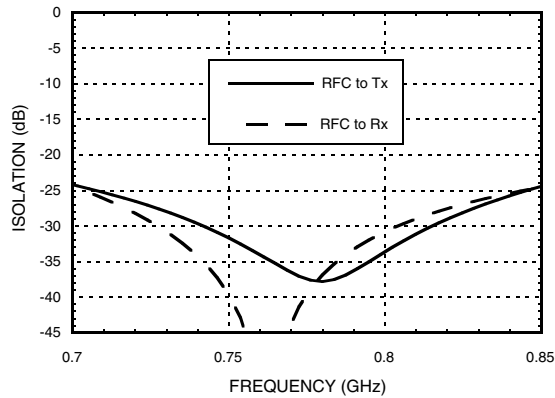

Return Loss with 785 MHz Tuning

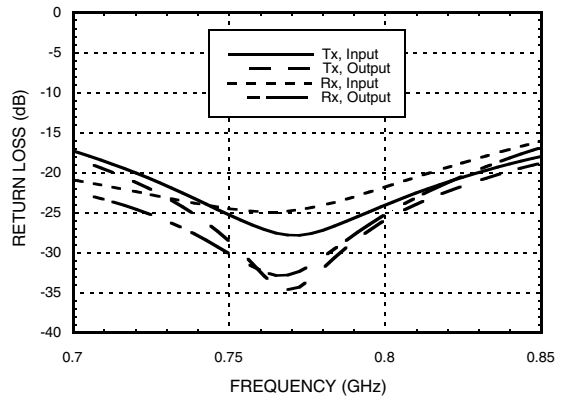

Input IP3 vs. Voltage with 785 MHz Tuning

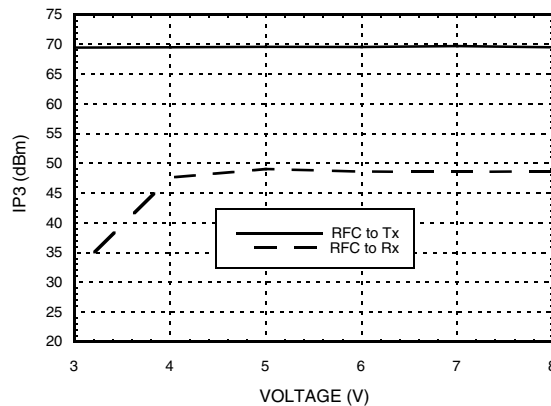



GaAs MMIC 20W FAILSAFE SWITCH
0.2 - 2.2 GHz

SWITCHES -SPDT T/R-SMT

Insertion Loss vs. Temperature, Tx with 915 MHz Tuning

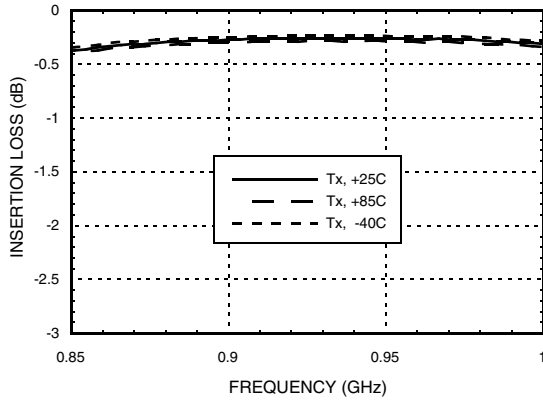

Insertion Loss vs. Temperature, Rx with 915 MHz Tuning

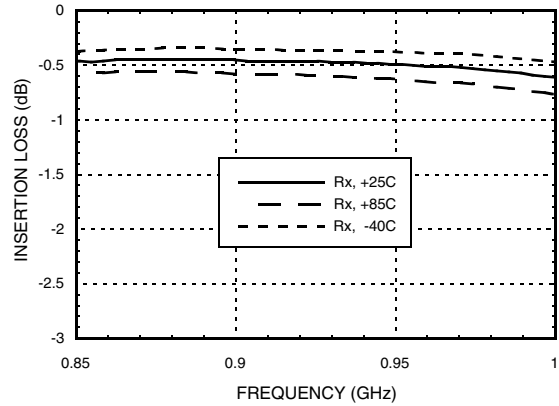

Isolation with 915 MHz Tuning

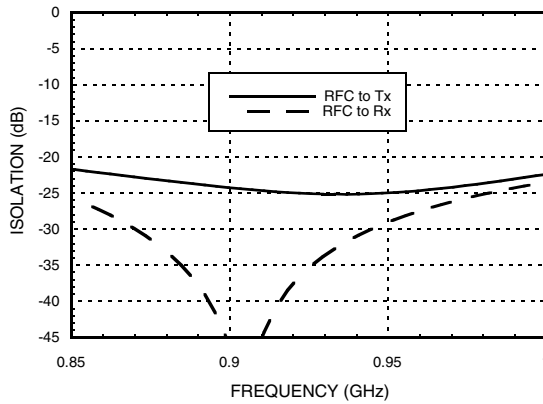

Return Loss with 915 MHz Tuning

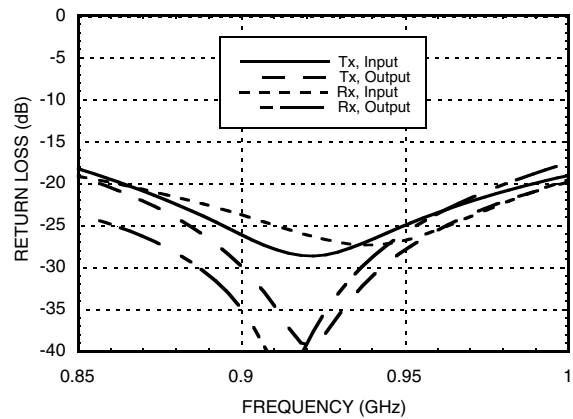

Input IP3 vs. Voltage with 915 MHz Tuning

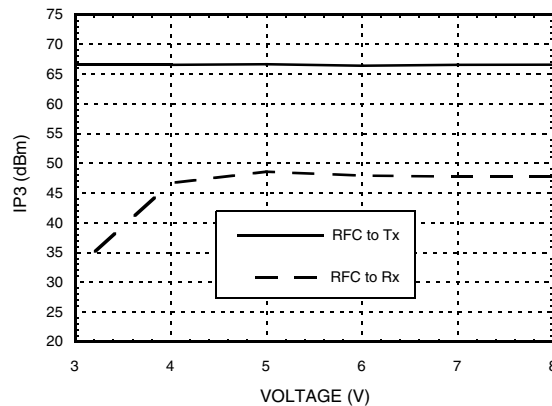



Insertion Loss vs. Temperature, Tx with 1843 MHz Tuning

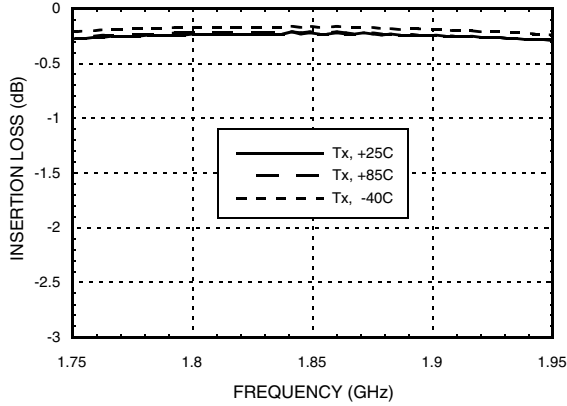

Insertion Loss vs. Temperature, Rx with 1843 MHz Tuning

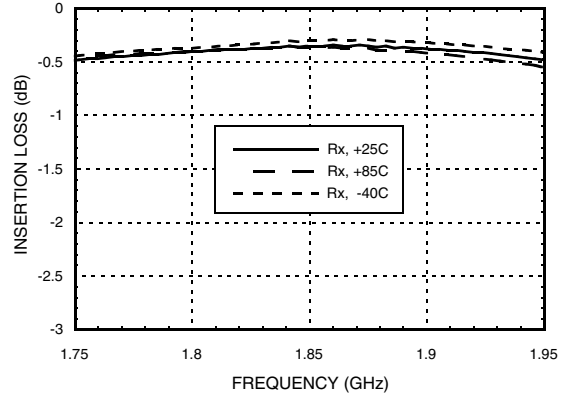

Isolation with 1843 MHz Tuning

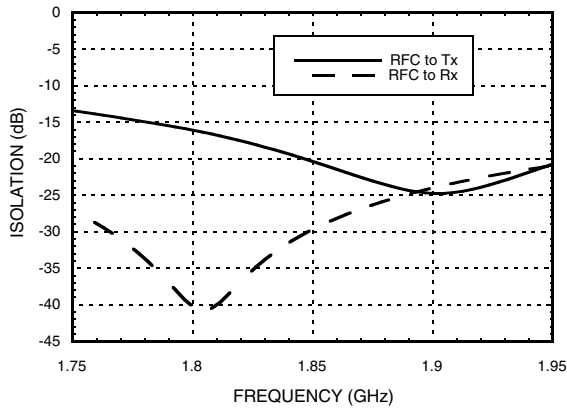

Return Loss with 1843 MHz Tuning

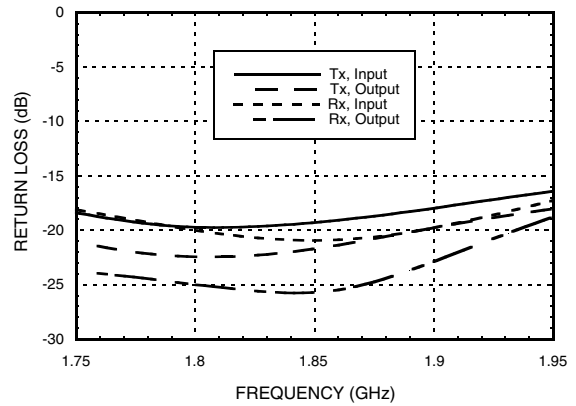

Input IP3 vs. Voltage with 1843 MHz Tuning

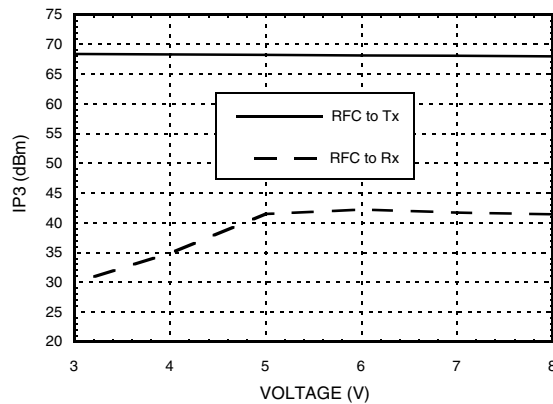



**GaAs MMIC 20W FAILSAFE SWITCH
0.2 - 2.2 GHz**

SWITCHES -SPDT T/R-SMT

Insertion Loss vs. Temperature, Tx with 1960 MHz Tuning

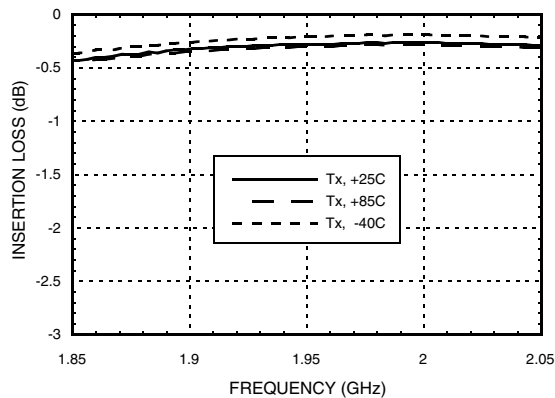

Insertion Loss vs. Temperature, Rx with 1960 MHz Tuning

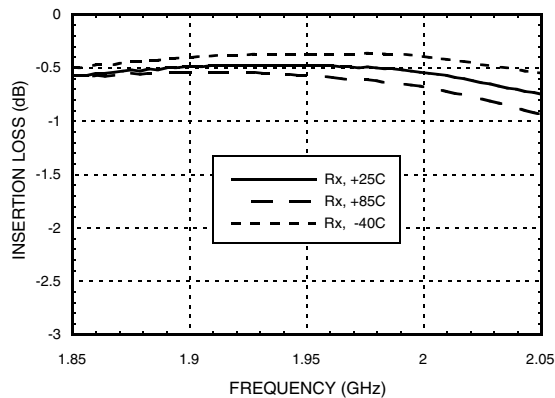

Isolation with 1960 MHz Tuning

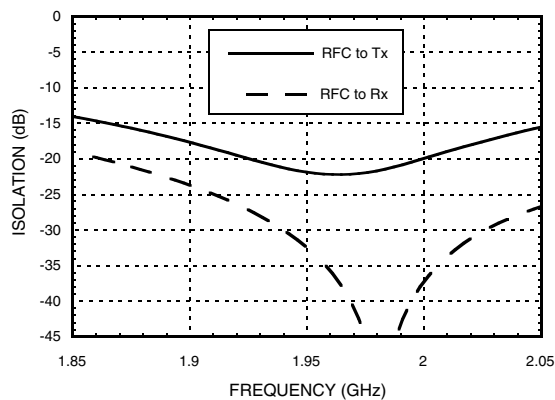

Return Loss with 1960 MHz Tuning

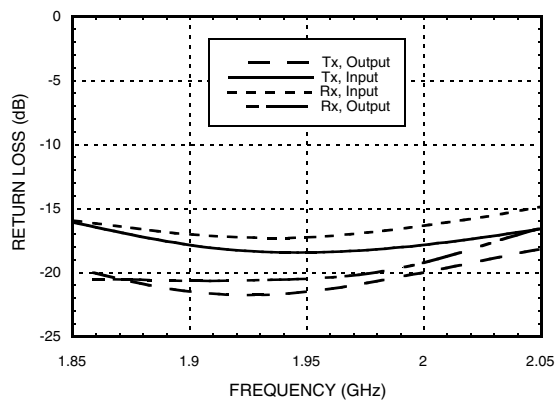

Input IP3 vs. Voltage with 1960 MHz Tuning

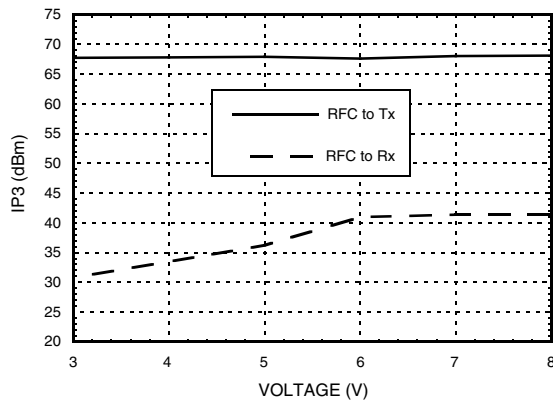



Insertion Loss vs. Temperature, Tx with 2015 MHz Tuning

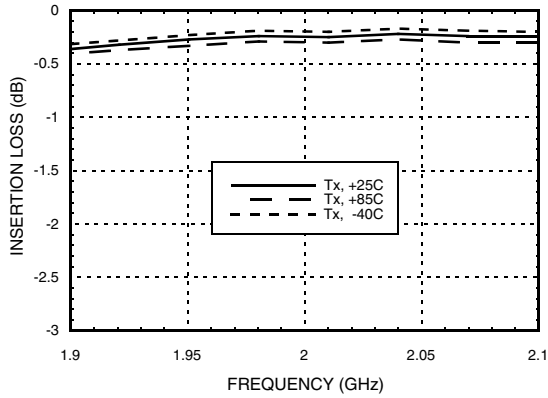

Insertion Loss vs. Temperature, Rx with 2015 MHz Tuning

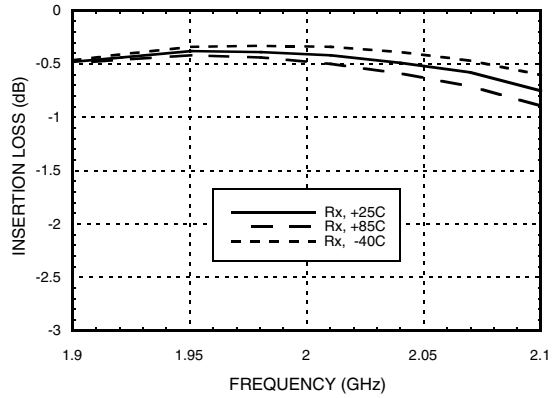

Isolation with 2015 MHz Tuning

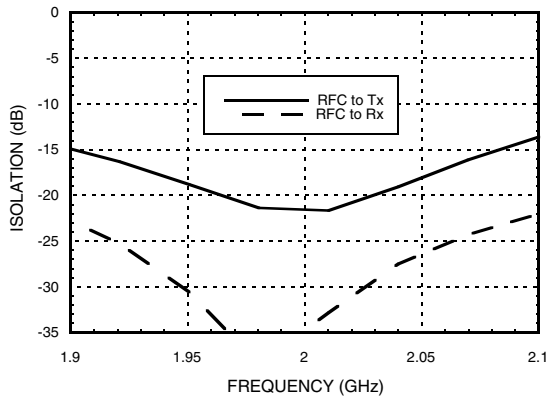

Return Loss with 2015 MHz Tuning

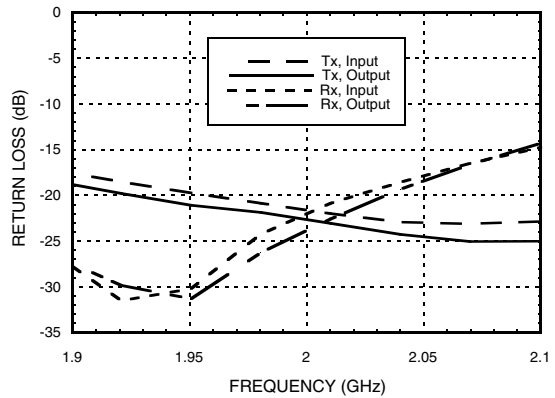

Input IP3 vs. Voltage with 2015 MHz Tuning

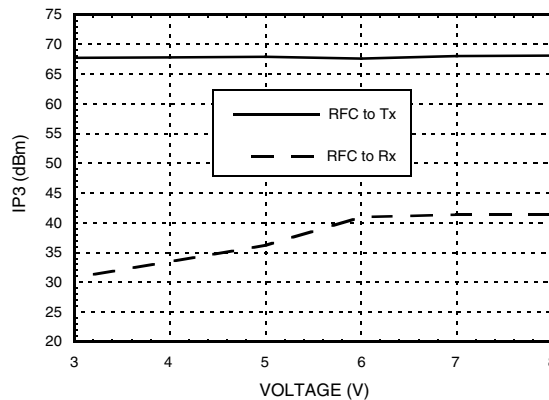



**GaAs MMIC 20W FAILSAFE SWITCH
0.2 - 2.2 GHz**

SWITCHES -SPDT T/R-SMT

Insertion Loss vs. Temperature, Tx with 2140 MHz Tuning

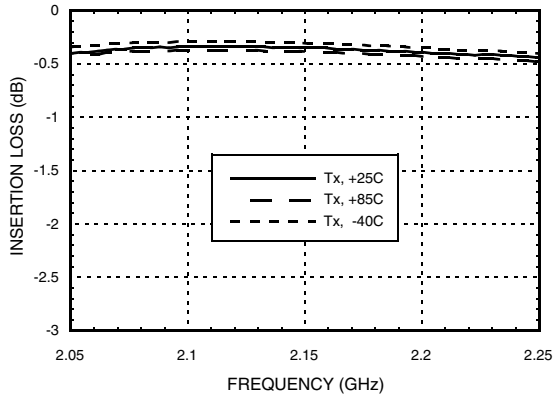

Insertion Loss vs. Temperature, Rx with 2140 MHz Tuning

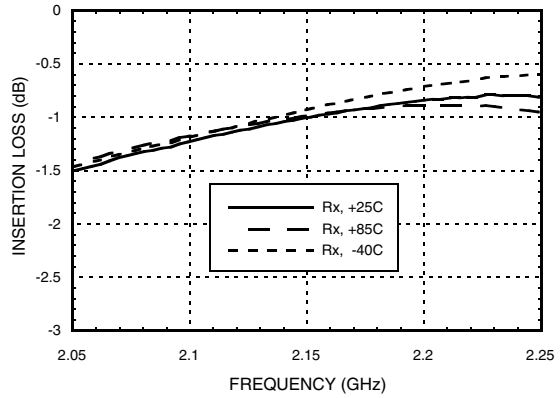

Isolation with 2140 MHz Tuning

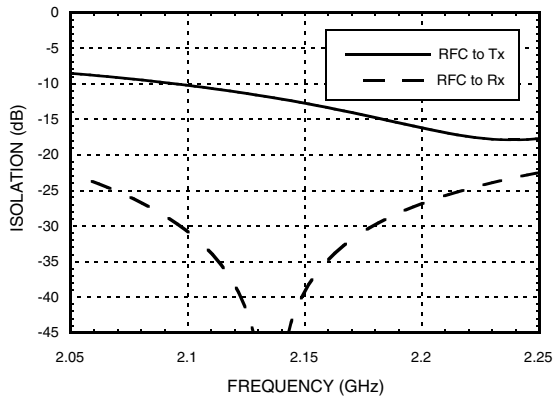

Return Loss with 2140 MHz Tuning

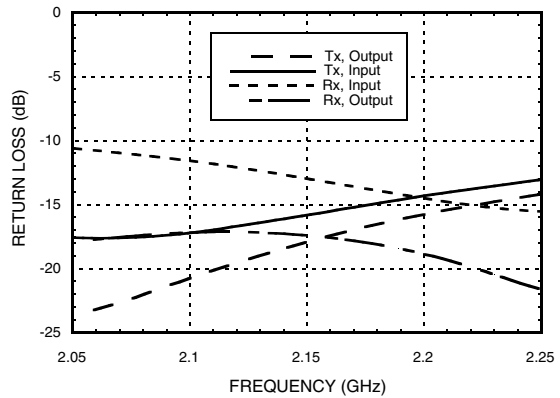

Input IP3 vs. Voltage with 2140 MHz Tuning

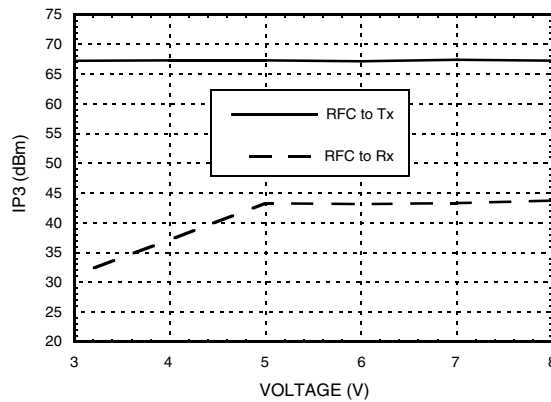

Absolute Maximum Ratings

| | | 3V | 5V |
|------------------------------|---------|------------------|---------|
| Max. CW Input Power [1][2] | Tx Port | 40 dBm | 40 dBm |
| | Rx Port | 24 dBm | 29 dBm |
| Max Channel Temp. | | 150 °C | 150 °C |
| Thermal Resistance | Tx Port | 54 °C/W | 54 °C/W |
| | Rx Port | 68 °C/W | 86 °C/W |
| Continuous Dissipated Power | Tx Port | 1.12 W | 1.12 W |
| | Rx Port | 73 mW | 232 mW |
| Supply Voltage (Vdd) | | +10V | |
| Control Voltage Range (Vctl) | | -0.2 to Vdd + 1V | |
| Storage Temperature | | -65 to +150 °C | |
| Operating Temperature | | -40 to +85 °C | |
| ESD Sensitivity (HBM) | | Class 1A | |

[1] Do not "hot switch" power levels greater than +24 dBm.
[2] Max input power can be higher for duty cycle <100%

Truth Table

| Control Input Vctl (V) | Signal Path State | |
|---------------------------|-------------------|-----------|
| | RFC To Tx | RFC to Rx |
| 0.0 | OFF | ON |
| Vdd | ON | OFF |

Vdd = +3V to +8V
Control Input Voltage Tolerances are ± 0.2 Vdc.

DC blocking capacitors are required at ports RFC, Tx and Rx.



ELECTROSTATIC SENSITIVE DEVICE
OBSERVE HANDLING PRECAUTIONS

Outline Drawing

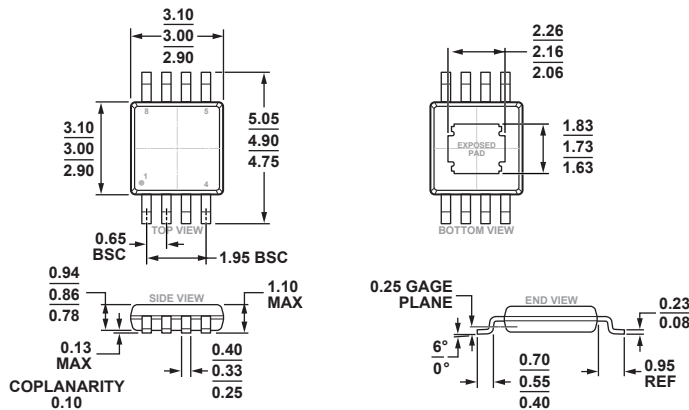

COMPLIANT TO JEDEC STANDARDS MO-187-AA-T

8-Lead Mini Small Outline Package with Exposed Pad [MINI_SO_EP]
(RH-8-1)
Dimensions shown in millimeters

Package Information

| Part Number | Package Body Material | Lead Finish | MSL Rating [1] | Package Marking [2] |
|---------------|--|---------------|----------------|---------------------|
| HMC546MS8GE | RoHS-compliant Low Stress Injection Molded Plastic | 100% matte Sn | MSL3 | H546 XXXX |
| HMC546MS8GETR | RoHS-compliant Low Stress Injection Molded Plastic | 100% matte Sn | MSL3 | H546 XXXX |

[1] Max peak reflow temperature of 260 °C

[2] 4-Digit lot number XXXX



GaAs MMIC 20W FAILSAFE SWITCH 0.2 - 2.2 GHz

Pin Descriptions

| Pin Number | Function | Description | Interface Schematic |
|------------|----------|---|---------------------|
| 1 | Tx | This pin is DC coupled and matched to 50 Ohms. | |
| 2, 7 | GND | This pin must be connected to PCB RF ground. | |
| 3 | Vctl | See Truth Table. | |
| 4 | ACG | External capacitor to ground is required. See application circuit herein. | |
| 5 | Rx | This pin is DC coupled and matched to 50 Ohms. | |
| 6 | Vdd | Supply Voltage | |
| 8 | RFc | This pin is DC coupled and matched to 50 Ohms. | |

Application Circuit

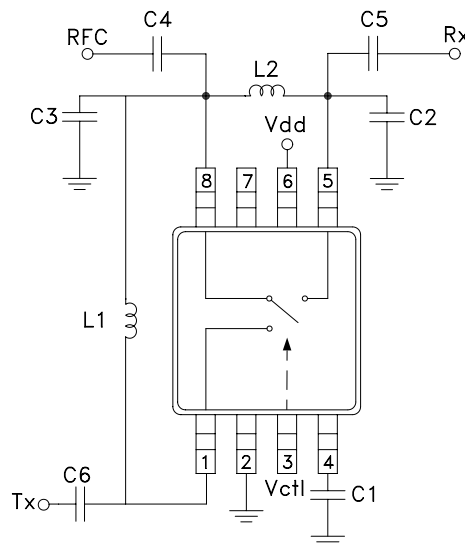

Components for Selected Frequencies

| Tuned Frequency | 220 MHz | 457 MHz | 785 MHz | 915 MHz | 1843 MHz | 1960 MHz | 2015 MHz | 2140 MHz |
|-----------------------|------------|------------|-----------|------------|------------|------------|------------|------------|
| Evaluation PCB Number | 110123 | 110124 | 110125 | 110126 | 110127 | 110128 | 115708 | 110129 |
| C1 | 150 pF | 33 pF | 11 pF | 8 pF | 1.6 pF | 1.5 pF | 1.3 pF | 1.2 pF |
| C2 | 12 pF | 6.2 pF | 2 pF | 1.8 pF | N/A | N/A | N/A | N/A |
| C3 | 12 pF | 7 pF | 3 pF | 2.7 pF | 1 pF | 1 pF | 0.9 pF | 1 pF |
| C4-C6 [1] | 1000pF | 1000pF | 1000pF | 1000pF | 1000pF | 1000pF | 1000pF | 1000pF |
| L1 | 390 nH [2] | 100 nH [4] | 33 nH [4] | 23 nH [3] | 3.3 nH [3] | 2.4 nH [3] | 2.2 nH [3] | 1 nH [3] |
| L2 | 36 nH [3] | 15 nH [3] | 10 nH [3] | 8.2 nH [3] | 3.9 nH [3] | 3.6 nH [3] | 3.6 nH [3] | 2.7 nH [4] |

[1] DC blocking capacitors

[2] Coilcraft 0603LS series inductor, 5% tolerance

[3] Coilcraft 0402CS series inductor, 5% tolerance

[4] Toko LL1005-FH series inductor, 5% tolerance

For price, delivery, and to place orders: Analog Devices, Inc., One Technology Way, P.O. Box 9106, Norwood, MA 02062-9106
Phone: 781-329-4700 • Order online at www.analog.com
Application Support: Phone: 1-800-ANALOG-D