

## GaAs MMIC 6-BIT DIGITAL PHASE SHIFTER, 2.9 - 3.9 GHz

### Typical Applications

The HMC648ALP6E is ideal for:

- EW Receivers
- Weather & Military Radar
- Satellite Communications
- Beamforming Modules
- Phase Cancellation

### Functional Diagram

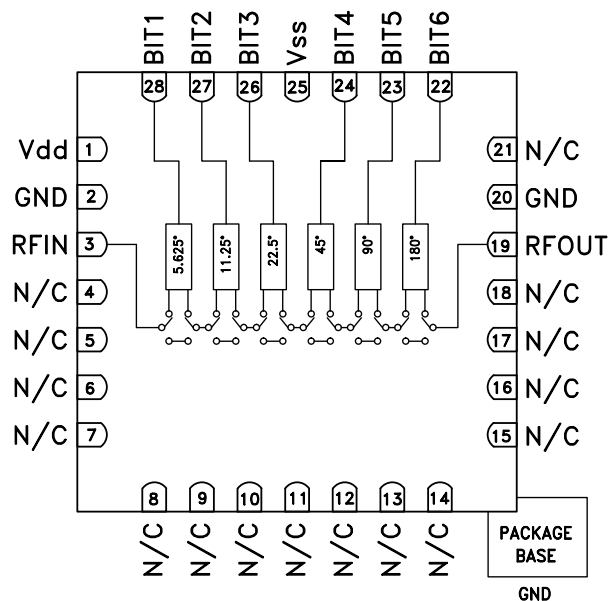

### Features

- Low RMS Phase Error: 1.2°
- Low Insertion Loss: 5 dB
- High Linearity: +45 dBm
- Positive Control Logic
- 360° Coverage, LSB = 5.625°
- 28 Lead 6x6mm SMT Package: 36mm<sup>2</sup>

### General Description

The HMC648ALP6E is a 6-bit digital phase shifter which is rated from 2.9 - 3.9 GHz, providing 360 degrees of phase coverage, with a LSB of 5.625 degrees. The HMC648ALP6E features very low RMS phase error of 1.2 degrees and extremely low insertion loss variation of  $\pm 0.5$  dB across all phase states. This high accuracy phase shifter is controlled with positive control logic of 0/+5V. The HMC648ALP6E is housed in a compact 6x6 mm plastic leadless SMT package and is internally matched to 50 Ohms with no external components.

### Electrical Specifications

$T_A = +25^\circ\text{C}$ ,  $V_{SS} = -5\text{V}$ ,  $V_{DD} = +5\text{V}$ , Control Voltage = 0/ +5V, 50 Ohm System

| Parameter   | Min. | Typ.      | Max.      | Units         |
|---|------|-----------|-----------|---------------|
| Frequency Range   | 2.9  |           | 3.9       | GHz           |
| Insertion Loss*   |      | 5         | 8         | dB            |
| Input Return Loss*  |      | 16        |           | dB            |
| Output Return Loss*   |      | 17        |           | dB            |
| Phase Error*  |      | $\pm 5$   | +10 / -15 | deg           |
| RMS Phase Error   |      | 1.2       |           | deg           |
| Amplitude Settling Time (50% cntl to +/- 0.1dB margin of final RFout) |      | 175       |           | nS            |
| Phase Settling Time (50% cntl to +/- 1 degree margin of final RFout)  |      | 125       |           | nS            |
| Insertion Loss Variation*   |      | $\pm 0.5$ |           | dB            |
| Input Power for 1 dB Compression                                      |      | 31        |           | dBm           |
| Input Third Order Intercept   |      | 45        |           | dBm           |
| Control Voltage Current   |      | 35        | 250       | $\mu\text{A}$ |
| Bias Control Current  |      | 5         | 15        | mA            |

\*Note: Major States Shown

**GaAs MMIC 6-BIT DIGITAL  
PHASE SHIFTER, 2.9 - 3.9 GHz**

**Insertion Loss, Major States Only**

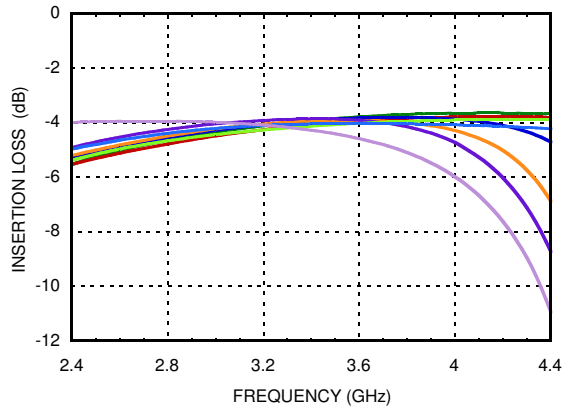

**Normalized Loss, Major States Only**

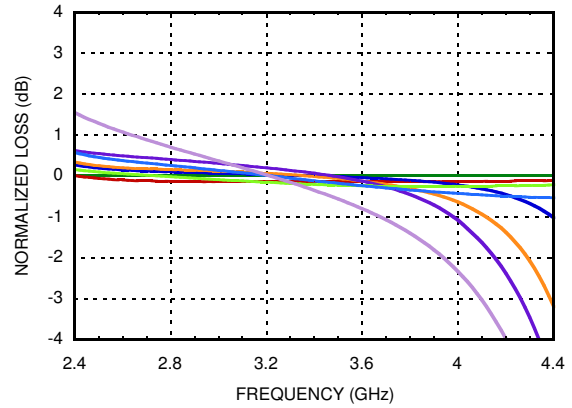

**Input Return Loss, Major States Only**

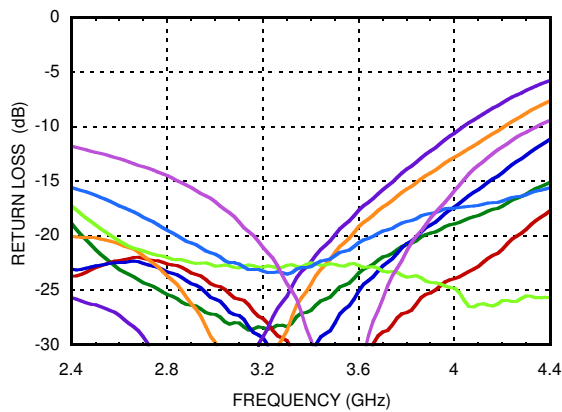

**Phase Error, Major States Only**

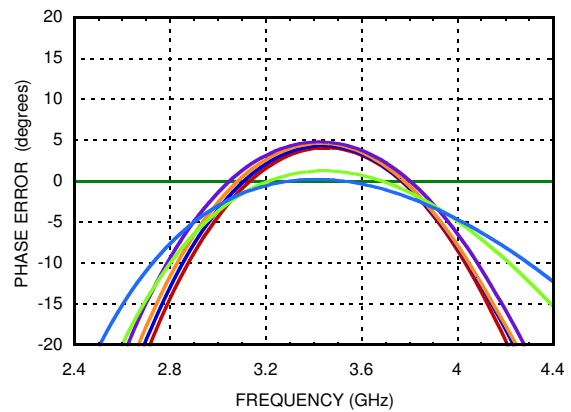

**Output Return Loss, Major States Only**

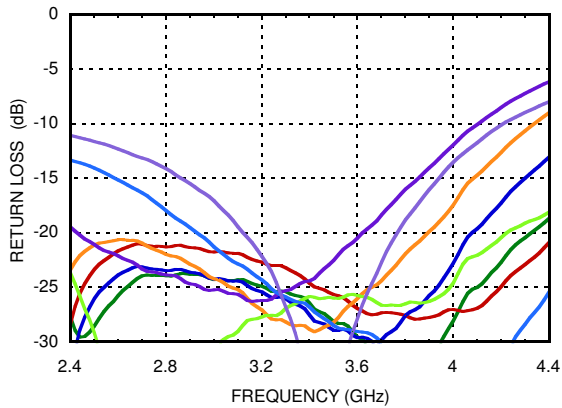

**Relative Phase Shift  
Major States Including All Bits**

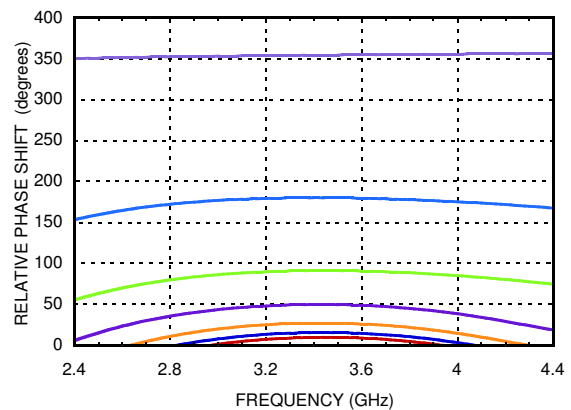

**GaAs MMIC 6-BIT DIGITAL  
PHASE SHIFTER, 2.9 - 3.9 GHz**

**Relative Phase Shift,  
RMS, Average, Max, All States**

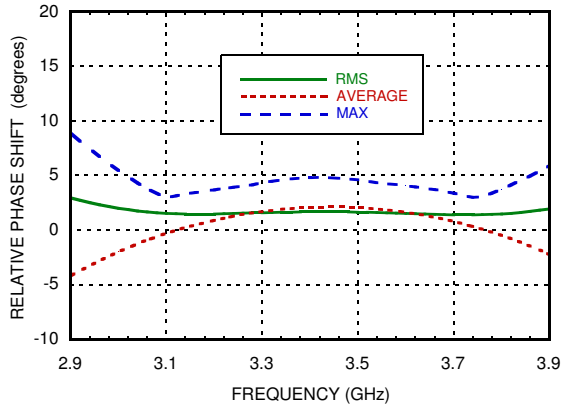

**Input IP3, Major States Only**

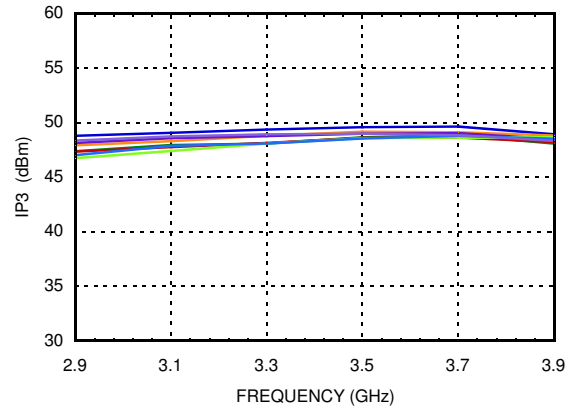

**Input P1dB, Major States Only**

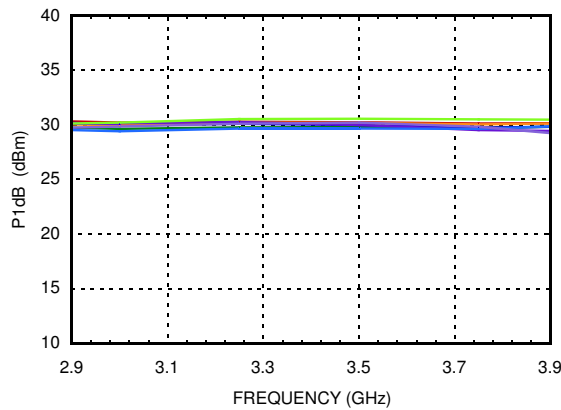

**RMS Phase Error vs. Temperature**

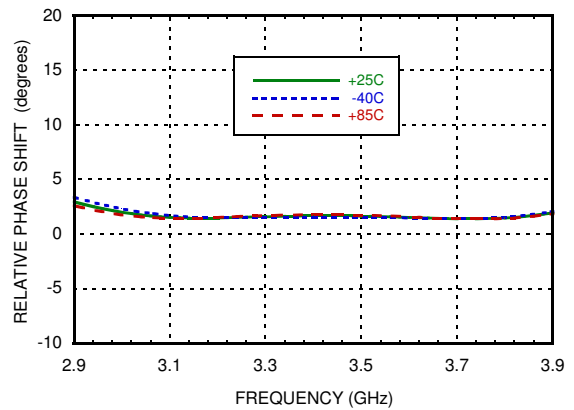

**Insertion Loss vs. Temperature,  
Major States Only**

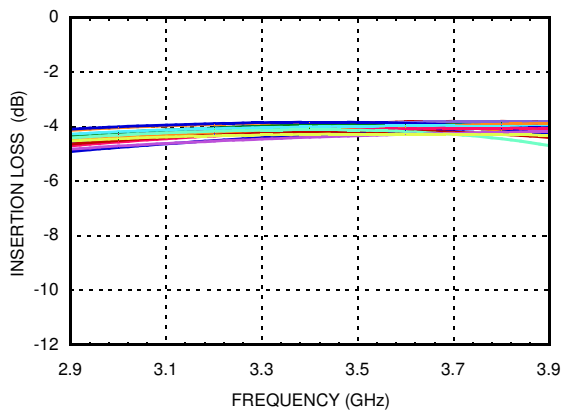

**Phase Error vs. State**

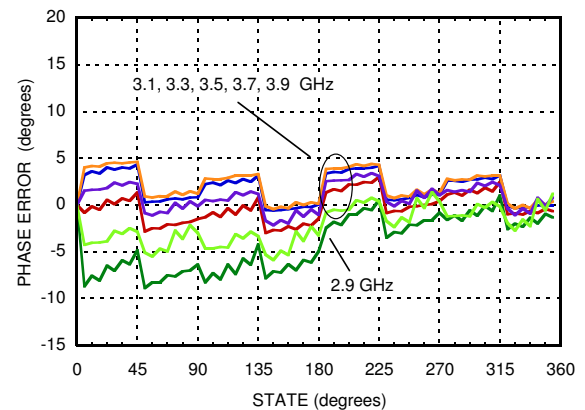

**GaAs MMIC 6-BIT DIGITAL  
PHASE SHIFTER, 2.9 - 3.9 GHz**
**Absolute Maximum Ratings**

|  |                     |
|--|---------------------|
| Input Power (RFIN)                               | 33 dBm (T= +85 °C)  |
| Bias Voltage Range (Vdd)                         | -0.2 to +12V        |
| Bias Voltage Range (Vss)                         | +0.2 to -12V        |
| Channel Temperature (Tc)                         | 150 °C              |
| Thermal Resistance<br>(channel to ground paddle) | 120 °C/W            |
| Storage Temperature                              | -65 to +150 °C      |
| Operating Temperature                            | -40 to +85 °C       |
| ESD Sensitivity                                  | Class1A Passed 250V |



**ELECTROSTATIC SENSITIVE DEVICE  
OBSERVE HANDLING PRECAUTIONS**

**Bias Voltage & Current**

|      |       |
|------|-------|
| Vdd  | Idd   |
| 5.0  | 5.2mA |
| Vss  | Iss   |
| -5.0 | 5.2mA |

**Control Voltage**

|          |                           |
|----------|---------------------------|
| State    | Bias Condition            |
| Low (0)  | 0 to 0.2 Vdc              |
| High (1) | Vdd ±0.2 Vdc @ 35 µA Typ. |

**Truth Table**

| Control Voltage Input |       |       |       |       |       | Phase Shift<br>(Degrees)<br>RFIN - RFOUT |
|-----------------------|-------|-------|-------|-------|-------|--|
| Bit 1                 | Bit 2 | Bit 3 | Bit 4 | Bit 5 | Bit 6 |  |
| 0                     | 0     | 0     | 0     | 0     | 0     | Reference*                               |
| 1                     | 0     | 0     | 0     | 0     | 0     | 5.625                                    |
| 0                     | 1     | 0     | 0     | 0     | 0     | 11.25                                    |
| 0                     | 0     | 1     | 0     | 0     | 0     | 22.5                                     |
| 0                     | 0     | 0     | 1     | 0     | 0     | 45.0                                     |
| 0                     | 0     | 0     | 0     | 1     | 0     | 90.0                                     |
| 0                     | 0     | 0     | 0     | 0     | 1     | 180.0                                    |
| 1                     | 1     | 1     | 1     | 1     | 1     | 354.375                                  |

Any combination of the above states will provide a phase shift approximately equal to the sum of the bits selected.

\*Reference corresponds to monotonic setting

## GaAs MMIC 6-BIT DIGITAL PHASE SHIFTER, 2.9 - 3.9 GHz

### Outline Drawing

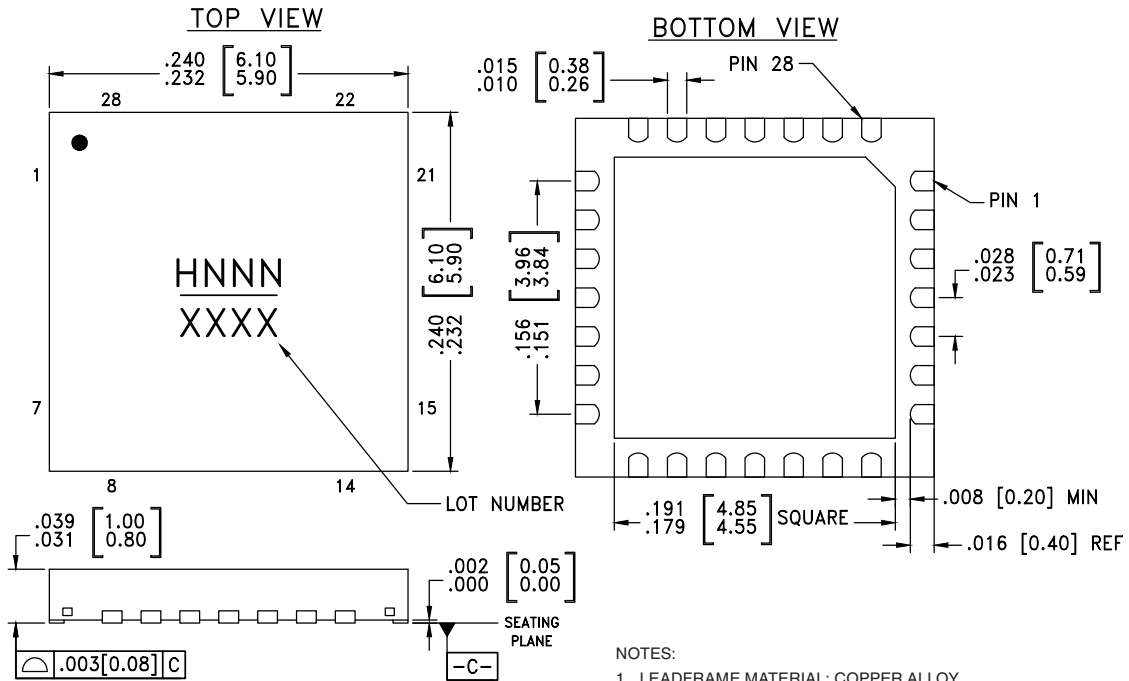

NOTES:

1. LEADFRAME MATERIAL: COPPER ALLOY
2. DIMENSIONS ARE IN INCHES [MILLIMETERS].
3. DIMENSION DOES NOT INCLUDE MOLDFLASH OF 0.15mm PER SIDE.
4. DIMENSION DOES NOT INCLUDE MOLDFLASH OF 0.25mm PER SIDE.
5. ALL GROUND LEADS MUST BE SOLDERED TO PCB RF GROUND.
6. CLASSIFIED AS MOISTURE SENSITIVITY LEVEL (MSL) 3.

### Package Information

| Part Number | Package Body Material                              | Lead Finish   | MSL Rating          | Package Marking <sup>[2]</sup> |
|-------------|--|---------------|---------------------|--------------------------------|
| HMC648ALP6E | RoHS-compliant Low Stress Injection Molded Plastic | 100% matte Sn | MSL3 <sup>[1]</sup> | H648A<br>XXXX                  |

[1] Max peak reflow temperature of 260 °C

[2] 4-Digit lot number XXXX

**GaAs MMIC 6-BIT DIGITAL  
PHASE SHIFTER, 2.9 - 3.9 GHz**
**Pin Descriptions**

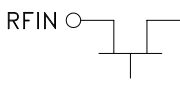
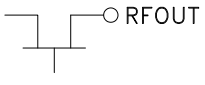
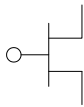
| Pin Number          | Function                              | Description  | Interface Schematic  |
|---------------------|---------------------------------------|--|--|
| 1                   | Vdd                                   | Voltage supply.  |  |
| 2, 20               | GND                                   | These pins and exposed ground paddle must be connected to RF/DC ground.  |   |
| 3                   | RFIN                                  | This port is DC coupled and matched to 50 Ohms.  |   |
| 4 - 18              | N/C                                   | The pins are not connected internally; however, all data shown herein was measured with these pins connected to RF/DC ground externally. |  |
| 19                  | RFOUT                                 | This port is DC coupled and matched to 50 Ohms.  |   |
| 22 - 24,<br>26 - 28 | BIT6, BIT5, BIT4,<br>BIT3, BIT2, BIT1 | Control Input. See truth table and control voltage tables.   |  |
| 25                  | Vss                                   | Voltage supply.  |  |

## GaAs MMIC 6-BIT DIGITAL PHASE SHIFTER, 2.9 - 3.9 GHz

### Evaluation PCB

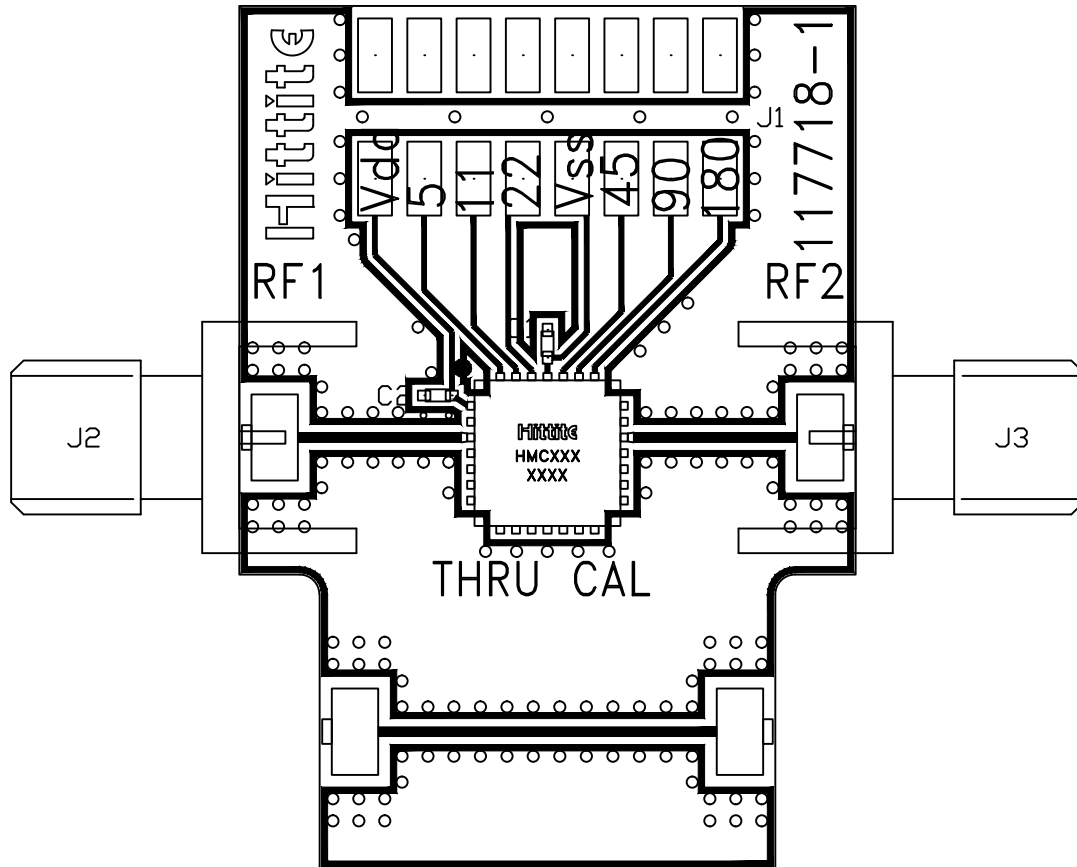

### List of Materials for Evaluation PCB 117720 <sup>[1][3]</sup>

| Item    | Description                             |
|---------|---|
| J1 - J2 | PCB Mount SMA RF Connector              |
| J3      | Header 2mm, 16 Pin                      |
| C1, C2  | 1000pF Capacitor, 0402 Pkg.             |
| U1      | HMC648ALP6E 6-Bit Digital Phase Shifter |
| PCB [2] | 117718 Evaluation PCB                   |

[1] Reference this number when ordering complete evaluation PCB

[2] Circuit Board Material: Rogers 4350

[3] Please refer to part's pin description and functional diagram for pin out assignments on evaluation board.

The circuit board used in the final application should use RF circuit design techniques. Signal lines should have 50 ohm impedance while the package ground leads and exposed paddle should be connected directly to the ground plane similar to that shown. A sufficient number of via holes should be used to connect the top and bottom ground planes. The evaluation board should be mounted to an appropriate heat sink. The evaluation circuit board shown is available from Analog Devices upon request.