

GaAs MMIC I/Q DOWNCONVERTER 37 - 44 GHz

Typical Applications

The HMC6789BLC5A is ideal for:

- Point-to-Point and Point-to-Multi-Point Radios
- Military Radar, EW & ELINT
- Satellite Communications
- Sensors

Features

- Conversion Gain: 14 dB
- Image Rejection: 25 dBc
- Input Third-Order Intercept (IP3): -1 dBm
- LO Drive Range: -3 to +6 dBm
- Gain Flatness: ± 1.5 dB
- 16 Terminal, 5 mm x 5 mm Ceramic Leadless Chip Carrier (LCC) Package

Functional Diagram

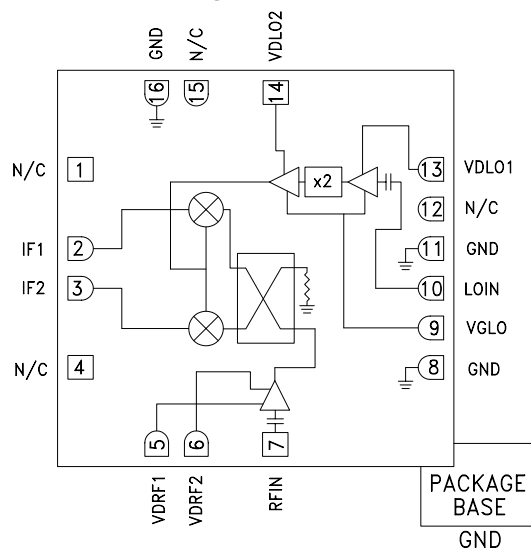

General Description

The HMC6789BLC5A is a compact GaAs MMIC I/Q downconverter in a 12-terminal, RoHS compliant, ceramic leadless chip carrier (LCC) package. This device provides a small signal conversion gain of 14 dB with 25 dBc of image rejection. The HMC6789BLC5A utilizes a low noise amplifier to drive the I/Q mixer where the LO is driven by a x2 multiplier. IF1 and IF2 mixer inputs are provided and an external 90° hybrid is needed to select the required sideband. The I/Q mixer topology reduces the need for filtering of the unwanted sideband. The HMC6789BLC5A is a much smaller alternative to hybrid style single sideband downconverter assemblies and it eliminates the need for wire bonding by allowing the use of surface mount manufacturing techniques.

Electrical Specifications, $T_A = 25^\circ\text{C}$, IF = 3.3 GHz, LO = 3 dBm, VDLO1 = 3 V, VDLO2 = 3 V, VDRF1 = 3 V, VDRF2 = 3 V. [1][2]

Parameter	Min.	Typ.	Max.	Units
RF Frequency Range	37		44	GHz
LO Frequency Range	16.5		24	GHz
IF Frequency Range	DC		4	GHz
Conversion Gain	10	14		dB
Image Rejection	20	25		dBc
Output Power for 1 dB Compression [3]		1		dBm
Input Third-Order Intercept (IP3)	-4	-1		dBm
Noise Figure [4]		3.5		dB
Amplitude Balance		± 1.5		dB
Phase Balance		-18		degree
2 x LO Leakage at RFIN		-25		dBm
Supply Current, IDLO1 + IDLO2 quiescent [2]		150		mA
Supply Current, IDRF1 + IDRF2		75		mA

[1] All measurements performed with upper sideband selected and external 90° hybrid at the IF ports, unless otherwise noted.

[2] Adjust VGLO between -2 V and 0 V to achieve typical total IDLO (IDLO1 + IDLO2) = 150 mA with RF turned off.

[3] Board loss and hybrid loss not subtracted out.

[4] Measurement performed at LO = 4 dBm.

**GaAs MMIC I/Q DOWNCONVERTER
37 - 44 GHz**

Data Taken with Upper Sideband Selected, $T_A = 25^\circ\text{C}$, $IF = 3.3\text{ GHz}$, $RFIN = -26\text{ dBm}$, $LO\text{ Drive} = 3\text{ dBm}$, Unless Otherwise Noted

Conversion Gain vs. RF Frequency over Temperature

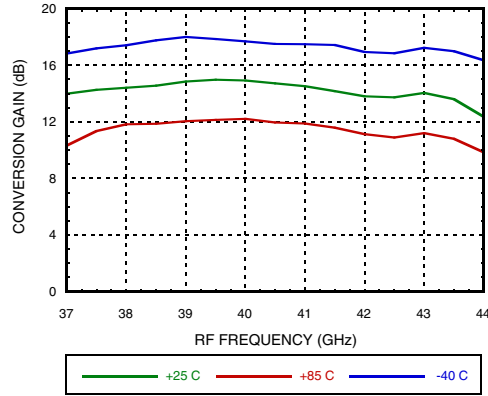

Conversion Gain vs. RF Frequency at Various LO Drives

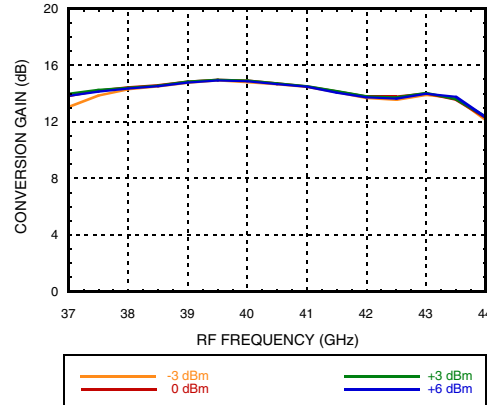

Image Rejection vs. RF Frequency over Temperature

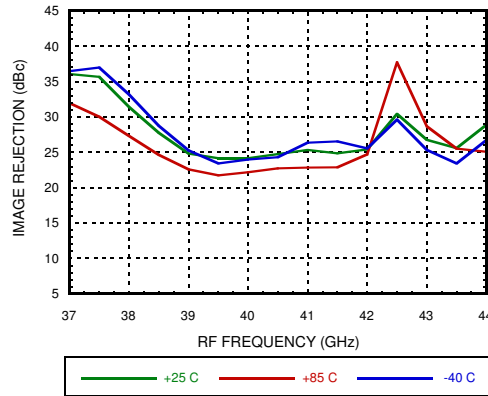
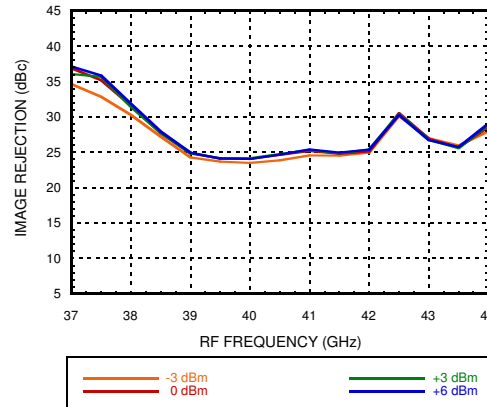
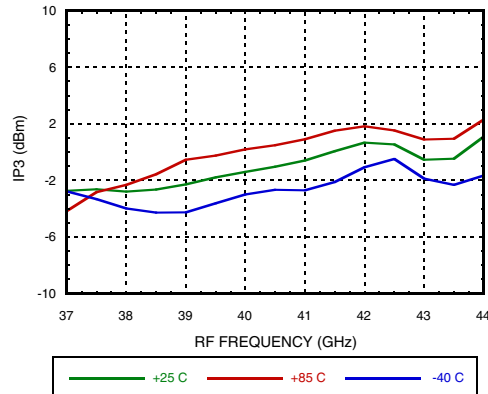

Image Rejection vs. RF Frequency at Various LO Drives



Input IP3 vs. RF Frequency over Temperature



Output IP3 vs. RF Frequency over Temperature

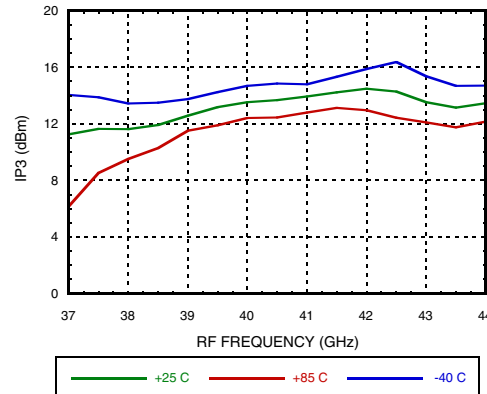

GaAs MMIC I/Q DOWNCONVERTER 37 - 44 GHz

Data Taken with Upper Sideband Selected, $T_A = 25^\circ\text{C}$, $IF = 3.3\text{ GHz}$, $RFIN = -26\text{ dBm}$, $LO\text{ Drive} = 3\text{ dBm}$, Unless Otherwise Noted

Input IP3 vs. RF Frequency at Various LO Drives

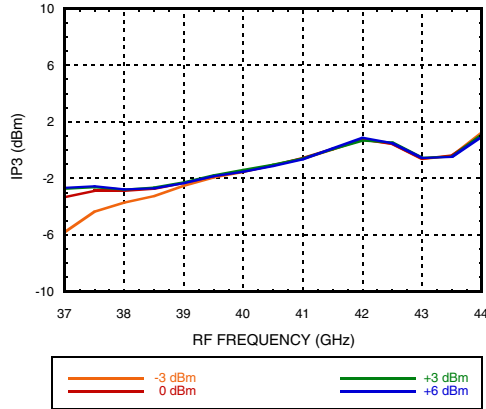

Output IP3 vs. RF Frequency at Various LO Drives

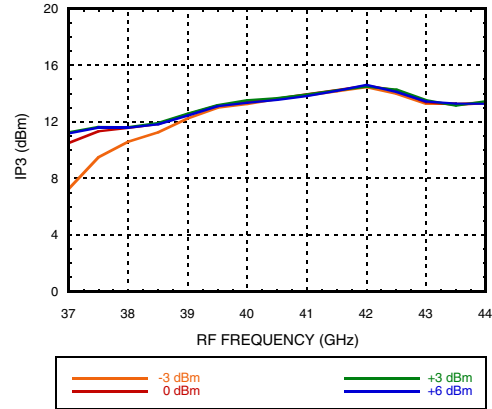

Input P1dB vs. RF Frequency over Temperature [1]

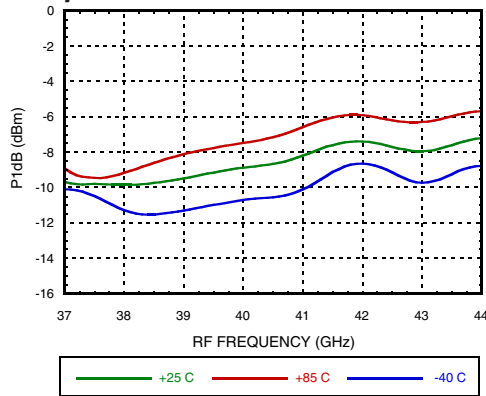

Output P1dB vs. RF Frequency over Temperature [1]

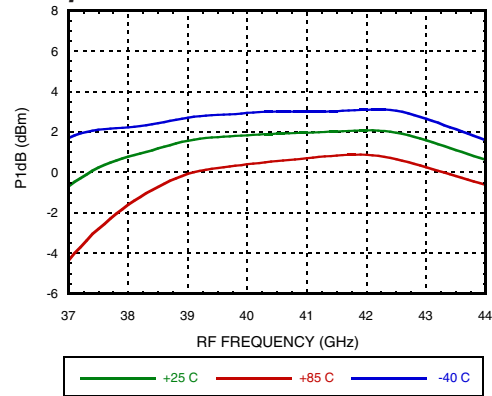

Noise Figure vs. RF Frequency over Temperature, LO Drive = 4 dBm

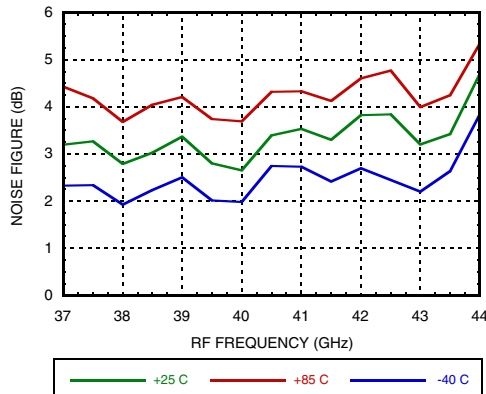

Noise Figure vs. RF Frequency at Various LO Drives

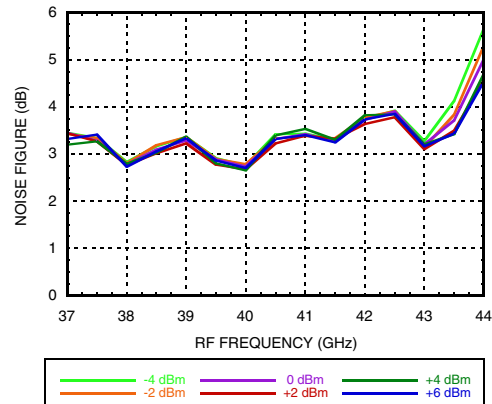

[1] Not compensated for board loss and hybrid loss

GaAs MMIC I/Q DOWNCONVERTER 37 - 44 GHz

Data Taken With Upper Sideband Selected, $T_A = 25^\circ\text{C}$, $IF = 3.3\text{ GHz}$, $RFIN = -26\text{ dBm}$, $LO\text{ Drive} = 3\text{ dBm}$, Unless Otherwise Noted

Amplitude Balance vs. RF Frequency over Temperature

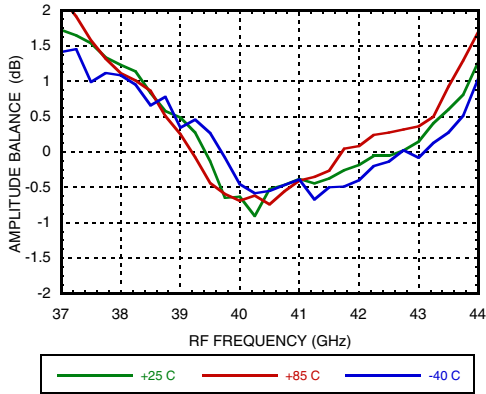

Amplitude Balance vs. RF Frequency at Various LO Drives

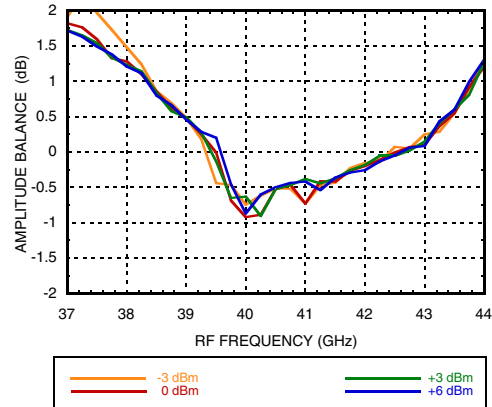

Phase Balance vs. RF Frequency over Temperature

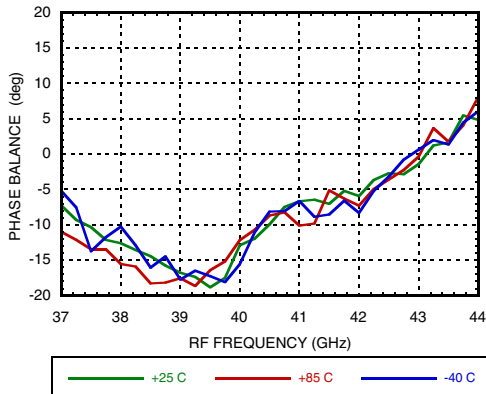

Phase Balance vs. RF Frequency at Various LO Drives

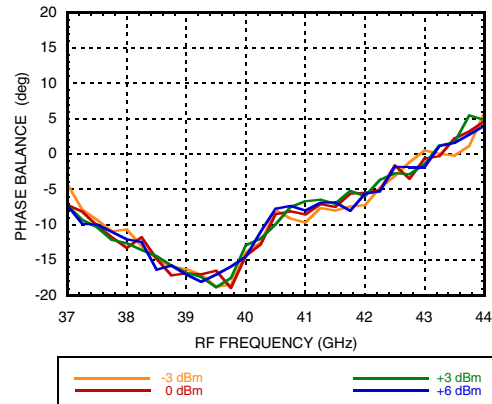

**GaAs MMIC I/Q DOWNCONVERTER
37 - 44 GHz**

Data Taken With Upper Sideband Selected, $T_A = 25^\circ\text{C}$, $IF = 2\text{ GHz}$, $RFIN = -26\text{ dBm}$, LO Drive = 3 dBm , Unless Otherwise Noted

Conversion Gain vs. RF Frequency over Temperature

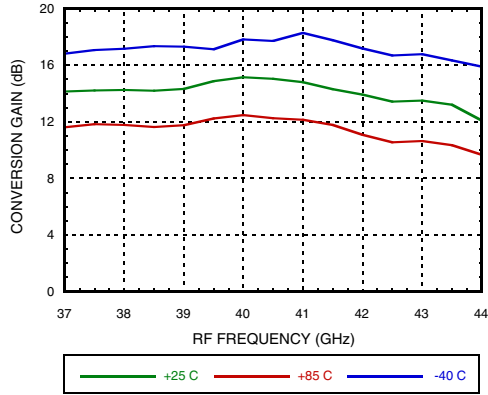

Conversion Gain vs. RF Frequency at Various LO Drives

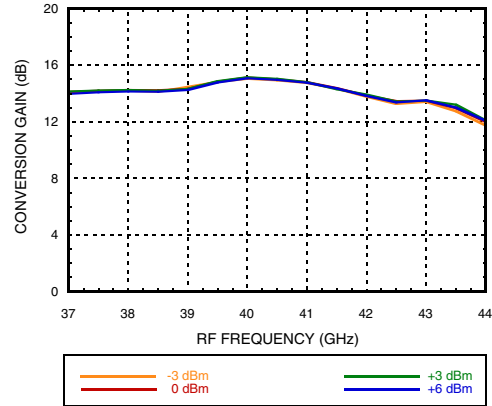

Image Rejection vs. RF Frequency over Temperature

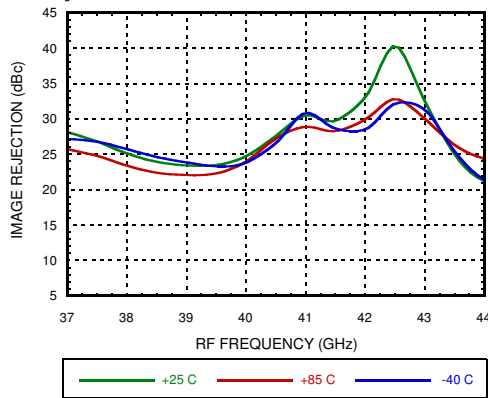
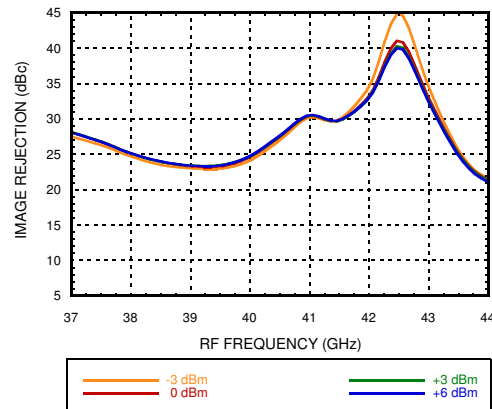
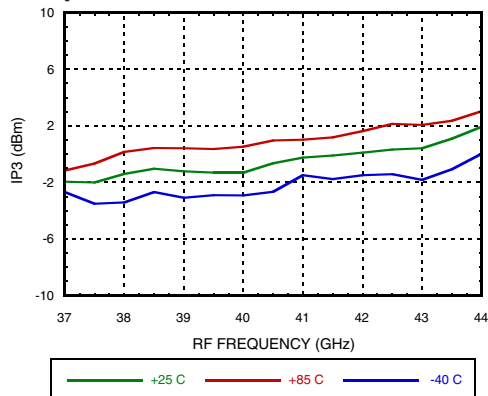

Image Rejection vs. RF Frequency at Various LO Drives



Input IP3 vs. RF Frequency over Temperature



Output IP3 vs. RF Frequency over Temperature

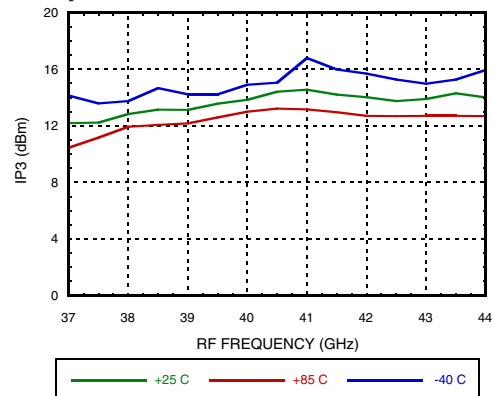

GaAs MMIC I/Q DOWNCONVERTER 37 - 44 GHz

Data Taken With Upper Sideband Selected, $T_A = 25^\circ\text{C}$, $IF = 2\text{ GHz}$, $RFIN = -26\text{ dBm}$, $LO\text{ Drive} = 3\text{ dBm}$, Unless Otherwise Noted

Input IP3 vs. RF Frequency at Various LO Drives

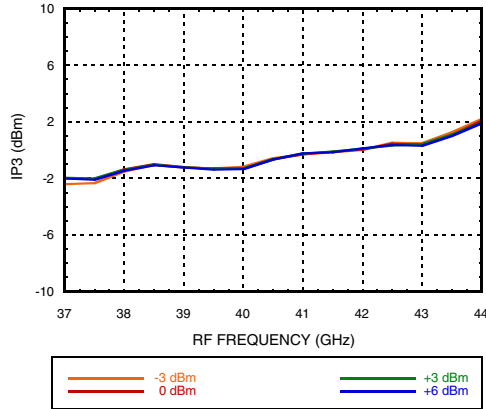

Output IP3 vs. RF Frequency at Various LO Drives

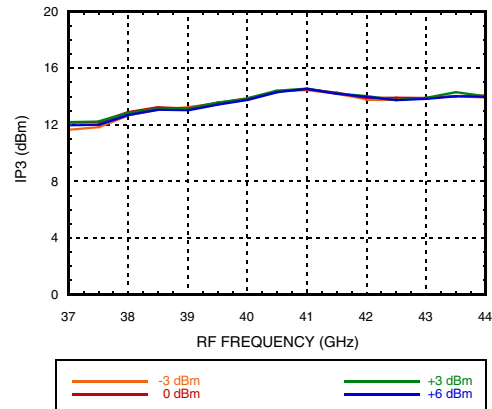

Input P1dB vs. RF Frequency over Temperature [1]

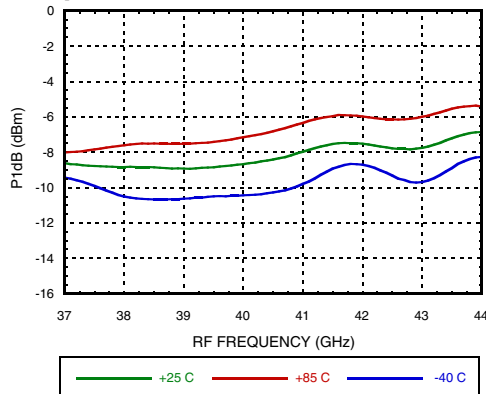

Output P1dB vs. RF Frequency over Temperature [1]

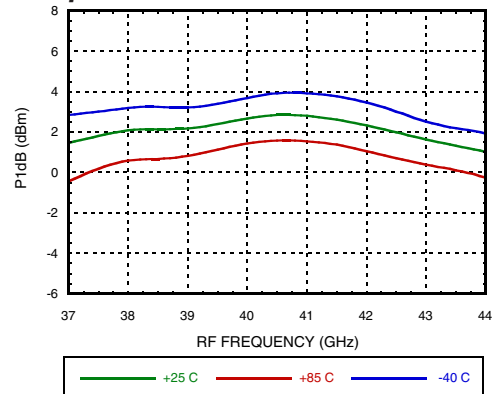

Noise Figure vs. RF Frequency over Temperature

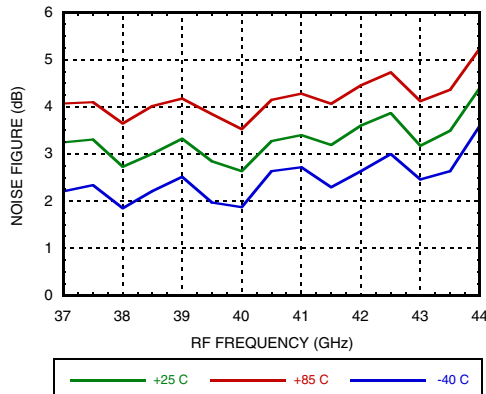

Noise Figure vs. RF Frequency at Various LO Drives

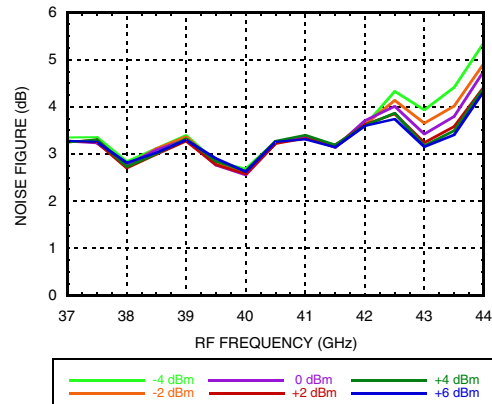

[1] Not compensated for board loss and hybrid loss.

**GaAs MMIC I/Q DOWNCONVERTER
37 - 44 GHz**

Data Taken With Upper Sideband Selected, $T_A = 25^\circ\text{C}$, $IF = 1\text{ GHz}$, $RFIN = -26\text{ dBm}$, LO Drive = 3 dBm , Unless Otherwise Noted

Conversion Gain vs. RF Frequency over Temperature

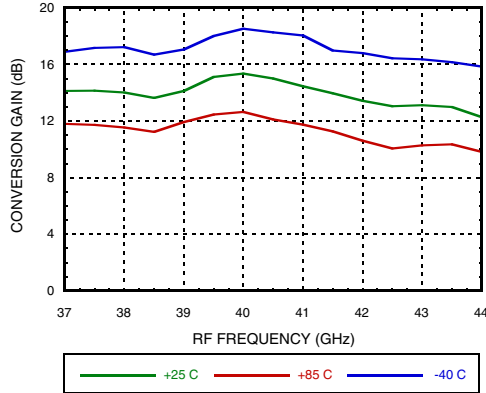

Conversion Gain vs. RF Frequency at Various LO Drives

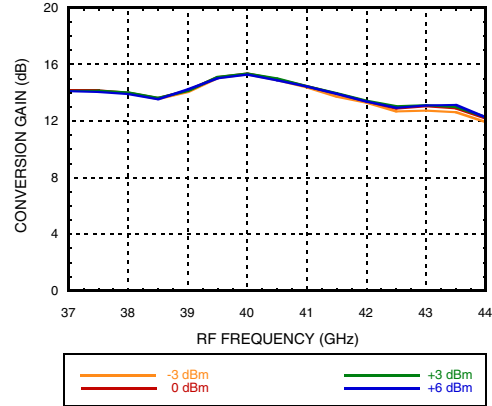

Image Rejection vs. RF Frequency over Temperature

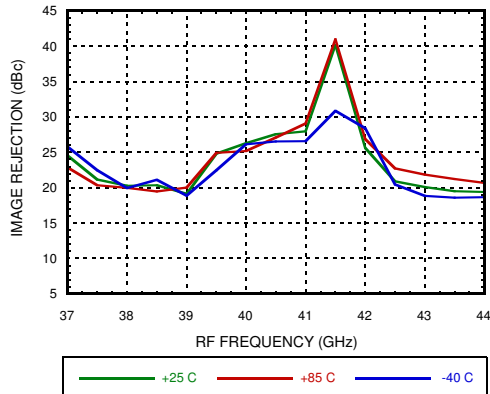
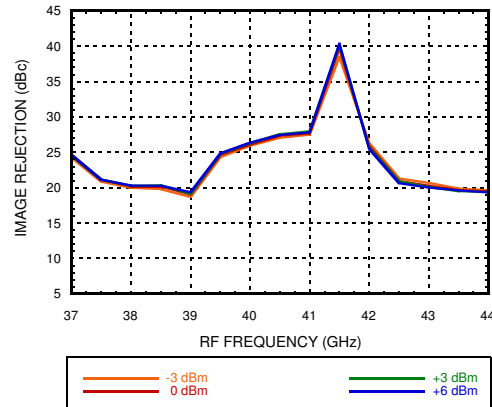
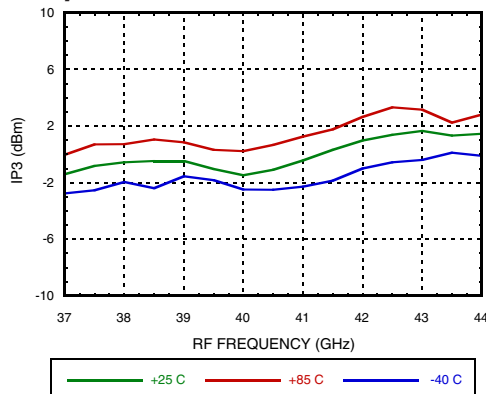

Image Rejection vs. RF Frequency at Various LO Drives



Input IP3 vs. RF Frequency over Temperature



Output IP3 vs. RF Frequency over Temperature

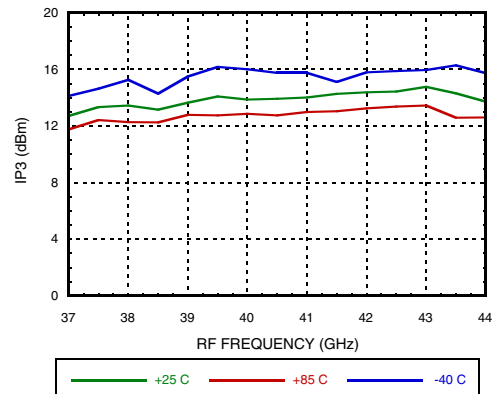

**GaAs MMIC I/Q DOWNCONVERTER
37 - 44 GHz**

Data Taken With Upper Sideband Selected, $T_A = 25^\circ\text{C}$, $IF = 1\text{ GHz}$, $RFIN = -26\text{ dBm}$, LO Drive = 3 dBm, Unless Otherwise Noted

Input IP3 vs. RF Frequency at Various LO Drives

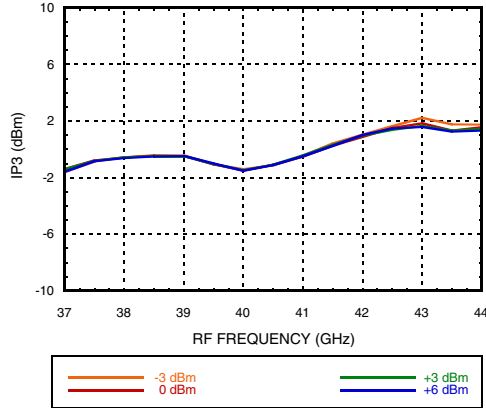

Output IP3 vs. RF Frequency at Various LO Drives

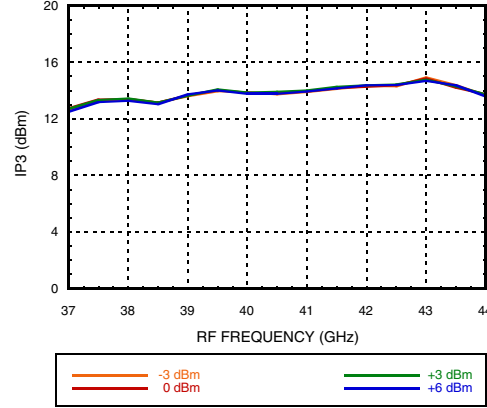

Input P1dB vs. RF Frequency over Temperature [1]

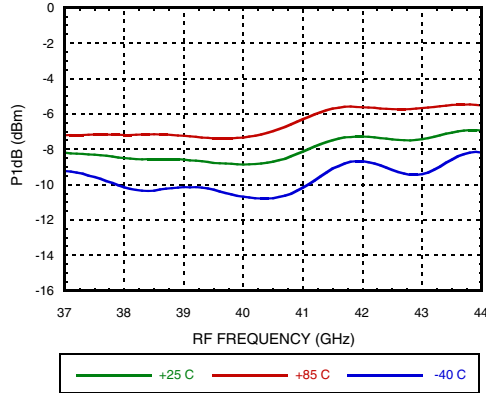

Output P1dB vs. RF Frequency over Temperature [1]

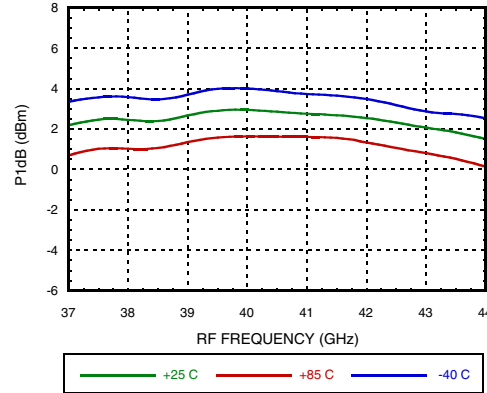

Noise Figure vs. RF Frequency over Temperature, LO Drive = 4 dBm

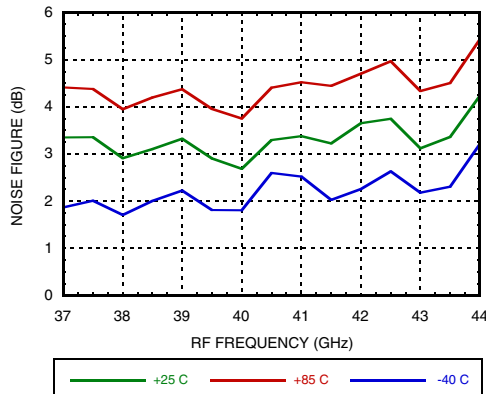

Noise Figure vs. RF Frequency at Various LO Drives

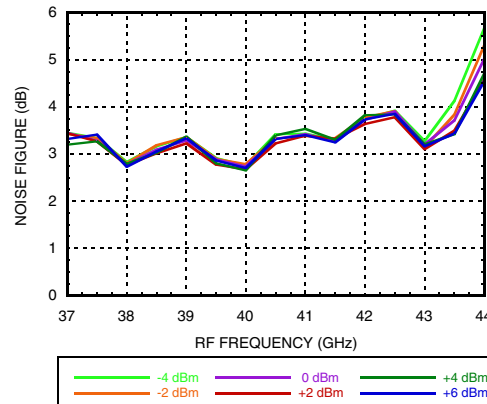

[1] Not compensated for board loss and hybrid loss.

GaAs MMIC I/Q DOWNCONVERTER 37 - 44 GHz

Data Taken With Upper Sideband Selected, $T_A = 25^\circ\text{C}$, $IF = 1\text{ GHz}$, $R_{FIN} = -26\text{ dBm}$,
LO Drive = 3 dBm, Unless Otherwise Noted

Amplitude Balance vs. RF Frequency over Temperature

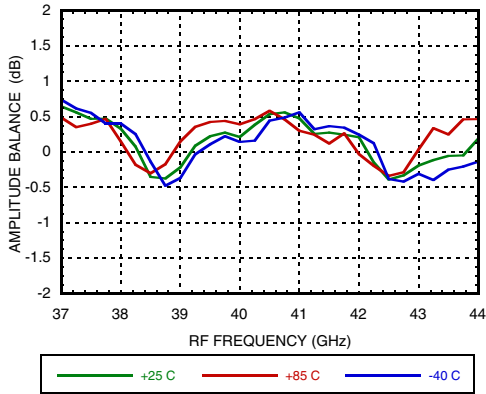

Amplitude Balance vs. RF Frequency at Various LO Drives

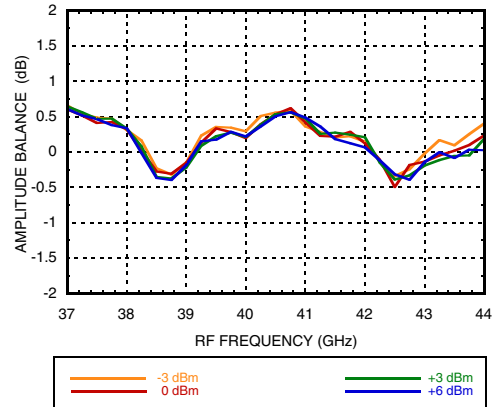

Phase Balance vs. RF Frequency over Temperature

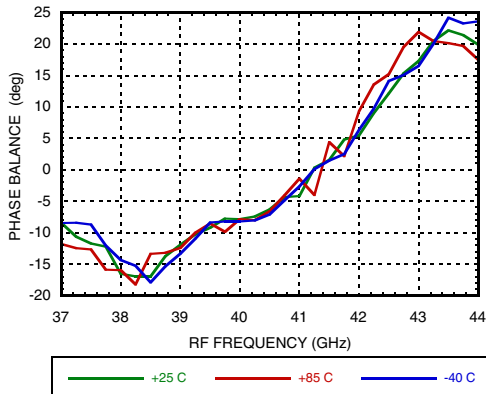

Phase Balance vs. RF Frequency at Various LO Drives

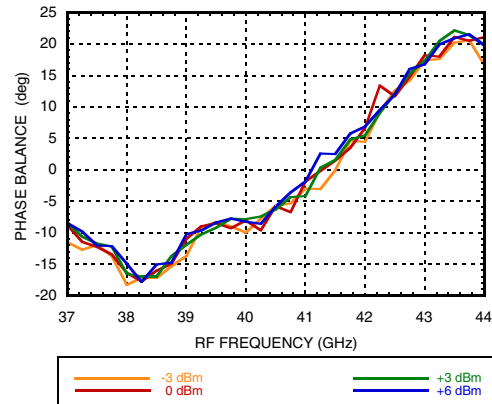

**GaAs MMIC I/Q DOWNCONVERTER
37 - 44 GHz**

IF Bandwidth vs. IF Frequency over Temperature, IFIN = -30 dBm [1]

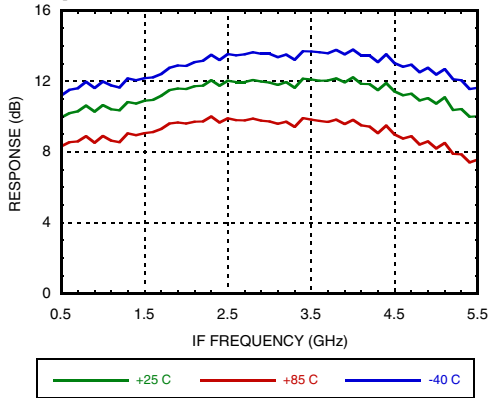

RF Return Loss vs. Frequency over Temperature, LO Drive = 3 dBm @ 21 GHz

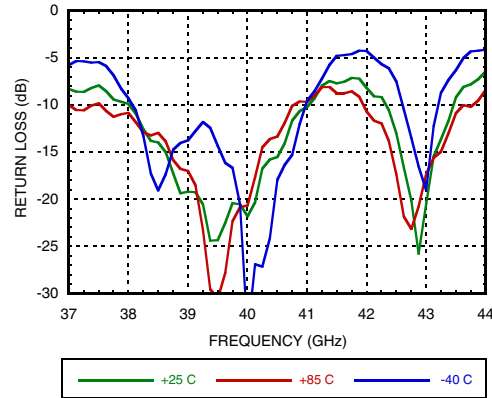

LO Return Loss vs. LO Frequency over Temperature, LO Drive = 3 dBm

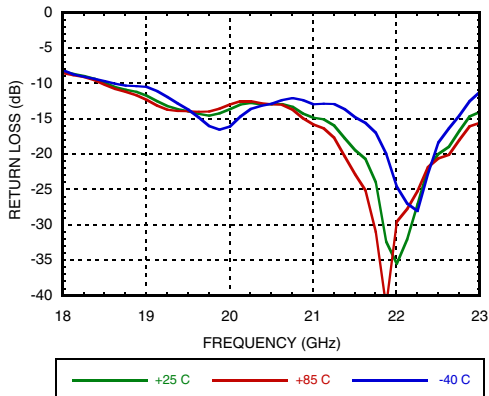

IF Return Loss vs. Frequency, IFIN = -25 dBm, LO Drive = 3 dBm @ 21 GHz [2]

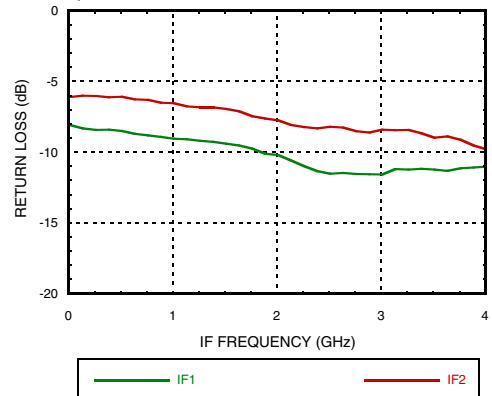

2 x LO Leakage at IFOUT & RFIN vs. LO Frequency, LO Drive = 3 dBm

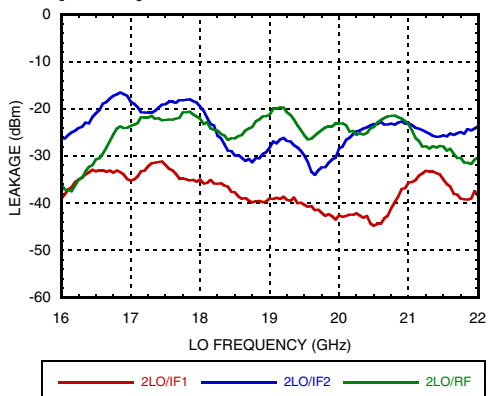

1 x LO Leakage at IFOUT & RFIN vs. LO Frequency, LO Drive = 3 dBm

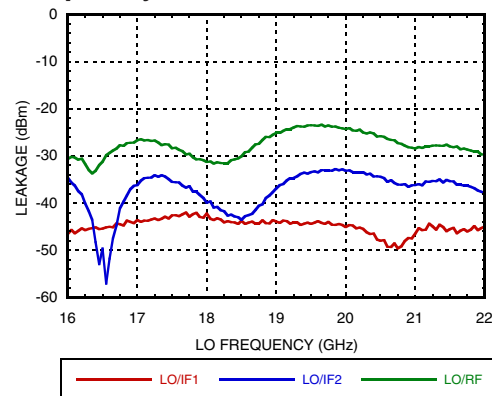

[1] Not compensated for board loss and hybrid loss.

[2] Data taken without external 90° IF hybrid.

GaAs MMIC I/Q DOWNCONVERTER 37 - 44 GHz

MxN Spurious Outputs, IF = 1 GHz ^[1]

mRF	nLO					
	0	2	4	6	8	10
0	xx	10.6				
1	19.3		38			
2		63.8	50.7	67.1		
3			63	74.2	70.6	
4				66.2	87.5	71.5
5					62.9	87.9

RF = 40 GHz @ -26 dBm

LO = 19.5 GHz @ +3 dBm

All values in dBc below IF power level (RF - 2LO)

Spur values are (M x RF) - (N x LO)

MxN Spurious Outputs, IF = 2 GHz ^[1]

mRF	nLO					
	0	2	4	6	8	10
0	xx	13.5				
1	18.4		30.5			
2		40.3	50.9	63.1		
3			64.3	74.4	75.7	
4				59.7	85	78.2
5					62.6	86.5

RF = 40 GHz @ -26 dBm

LO = 19 GHz @ +3 dBm

All values in dBc below IF power level (RF - 2LO)

Spur values are (M x RF) - (N x LO)

MxN Spurious Outputs, IF = 3.3 GHz ^[1]

mRF	nLO					
	0	2	4	6	8	10
0	xx	9.1				
1	17.7		28.6			
2		55.4	59.9	70.4		
3			50.7	75.2	71.9	
4				47	73.1	68.2
5						70.5

RF = 40 GHz @ -26 dBm

LO = 18.35 GHz @ +3 dBm

All values in dBc below IF power level (RF - 2LO)

Spur values are (M x RF) - (N x LO)

[1] Data taken without external IF 90° hybrid

GaAs MMIC I/Q DOWNCONVERTER 37 - 44 GHz

Data Taken With Lower Sideband Selected, $T_A = 25^\circ\text{C}$, $IF = 3.3\text{ GHz}$, $RFIN = -26\text{ dBm}$, LO Drive = 3 dBm , Unless Otherwise Noted

Conversion Gain vs. RF Frequency over Temperature

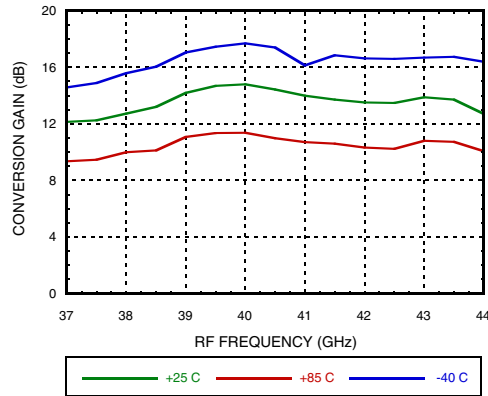

Conversion Gain vs. RF Frequency at Various LO Drives

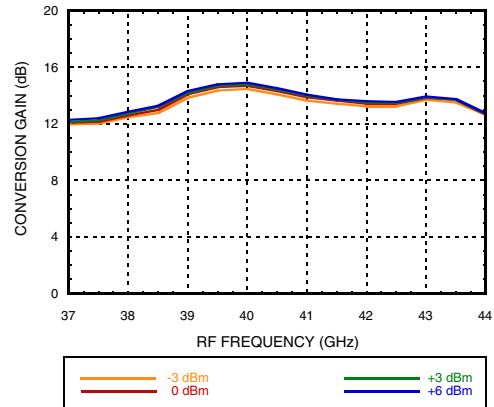

Image Rejection vs. RF Frequency over Temperature

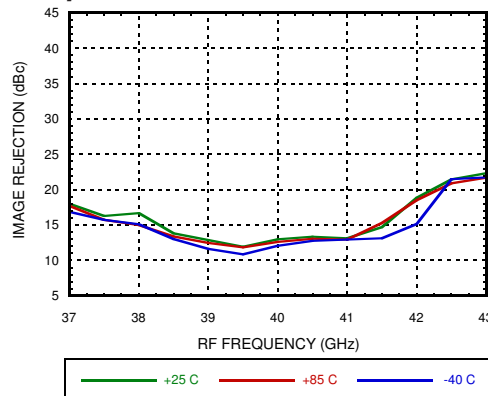
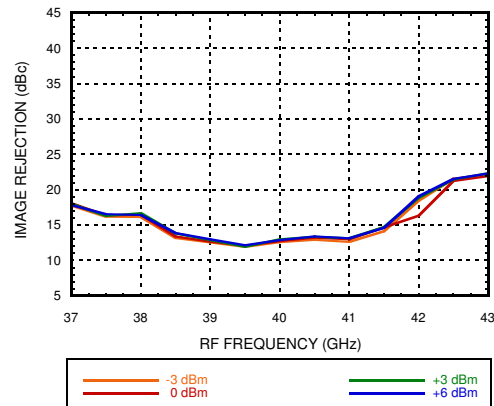
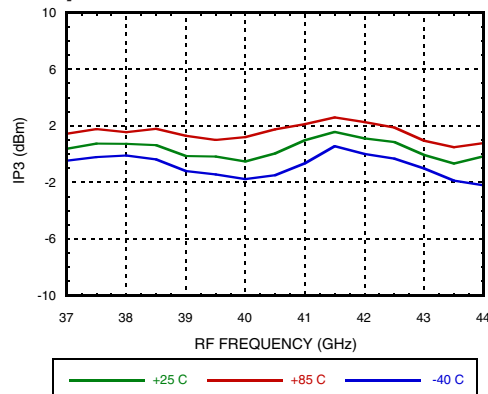

Image Rejection vs. RF Frequency at Various LO Drives



Input IP3 vs. RF Frequency over Temperature



Output IP3 vs. RF Frequency over Temperature

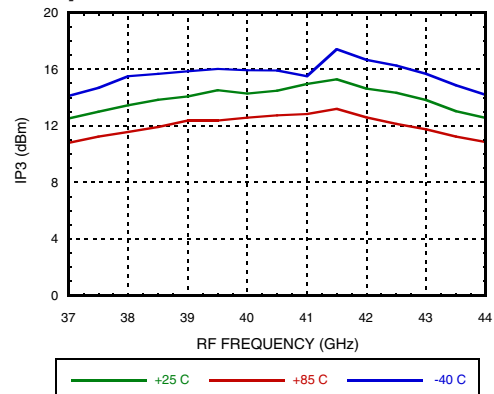

GaAs MMIC I/Q DOWNCONVERTER 37 - 44 GHz

Data Taken With Lower Sideband Selected, $T_A = 25^\circ\text{C}$, $IF = 3.3\text{ GHz}$, $RFIN = -26\text{ dBm}$, LO Drive = 3 dBm, Unless Otherwise Noted

Input IP3 vs. RF Frequency at Various LO Drives

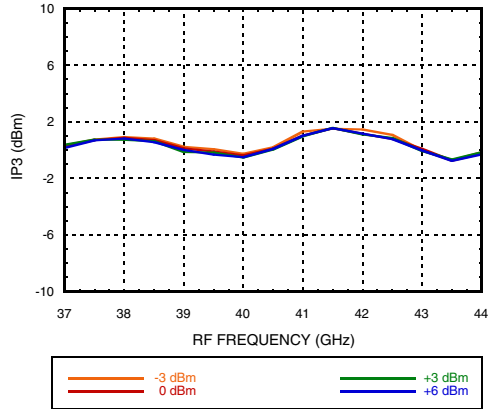

Output IP3 vs. RF Frequency at Various LO Drives

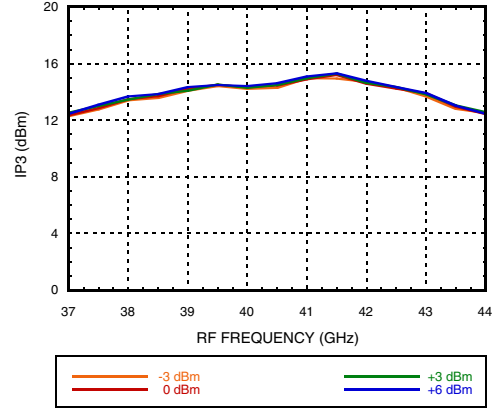

Input P1dB vs. RF Frequency over Temperature [1]

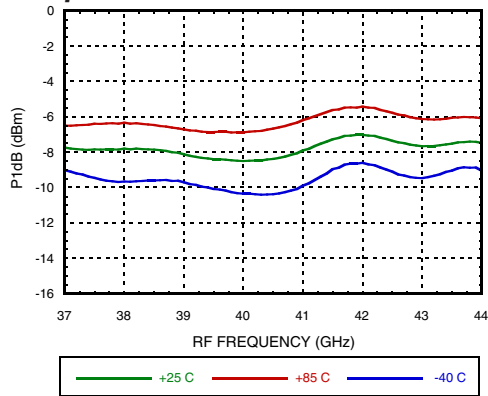

Output P1dB vs. RF Frequency over Temperature [1]

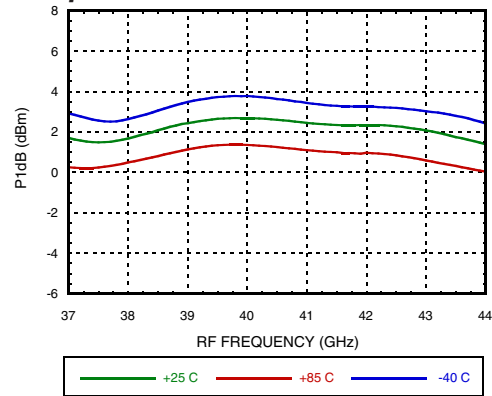

Noise Figure vs. RF Frequency over Temperature, LO Drive = 4 dBm

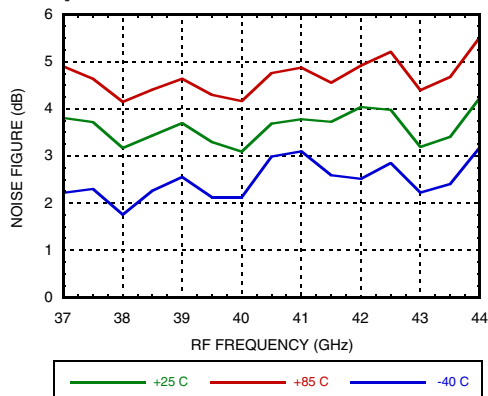

Noise Figure vs. RF Frequency at Various LO Drives

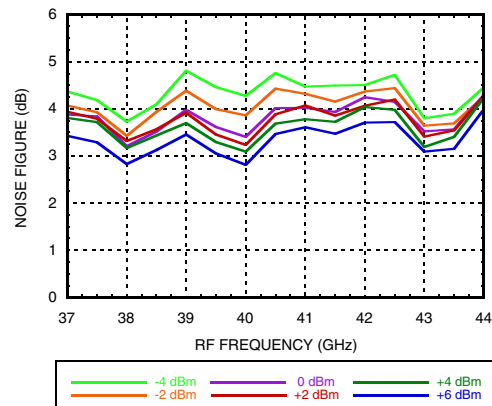

[1] Not compensated for board loss and hybrid loss

GaAs MMIC I/Q DOWNCONVERTER 37 - 44 GHz

Data Taken With Lower Sideband Selected, $T_A = 25^\circ\text{C}$, $IF = 3.3\text{ GHz}$, $RFIN = -26\text{ dBm}$, $LO\text{ Drive} = 3\text{ dBm}$, Unless Otherwise Noted

Amplitude Balance vs. RF Frequency over Temperature

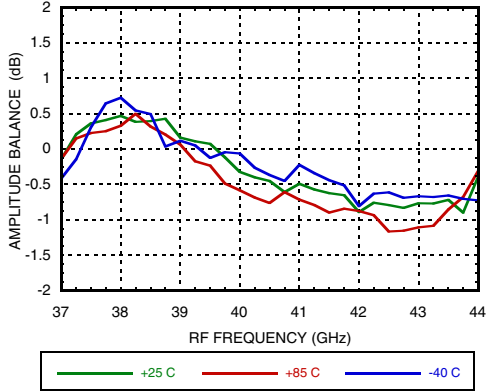

Amplitude Balance vs. RF Frequency at Various LO Drives

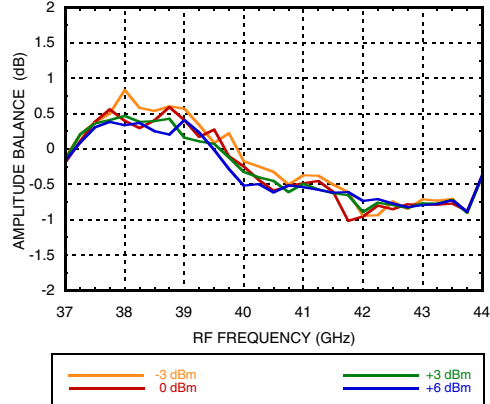

Phase Balance vs. RF Frequency over Temperature

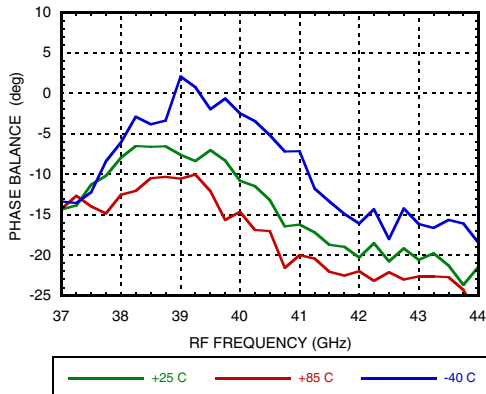

Phase Balance vs. RF Frequency at Various LO Drives

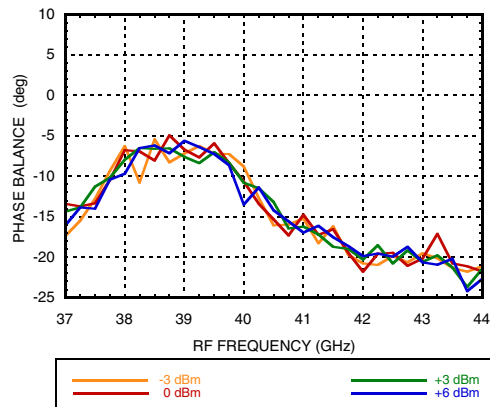

**GaAs MMIC I/Q DOWNCONVERTER
37 - 44 GHz**

Data Taken With Lower Sideband Selected, $T_A = 25^\circ\text{C}$, $IF = 2\text{ GHz}$, $RFIN = -26\text{ dBm}$, LO Drive = 3 dBm , Unless Otherwise Noted

Conversion Gain vs. RF Frequency over Temperature

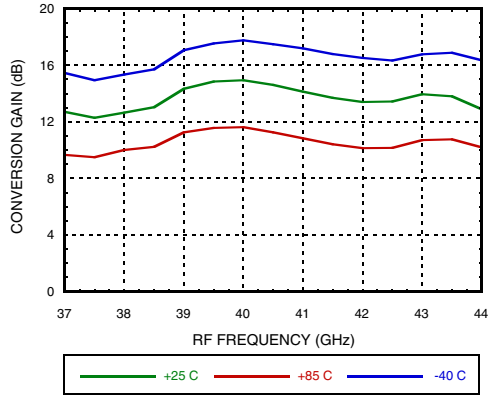

Conversion Gain vs. RF Frequency at Various LO Drives

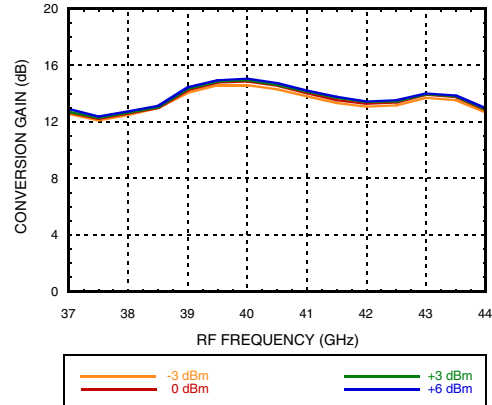

Image Rejection vs. RF Frequency over Temperature

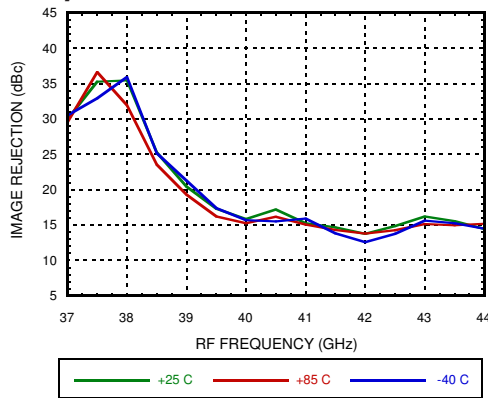
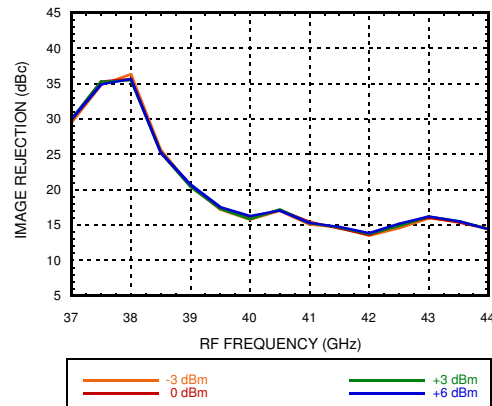
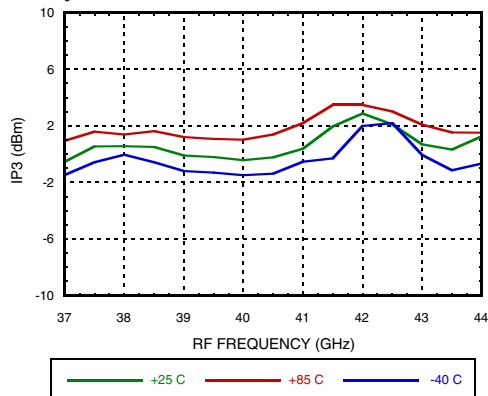

Image Rejection vs. RF Frequency at Various LO Drives



Input IP3 vs. RF Frequency over Temperature



Output IP3 vs. RF Frequency over Temperature

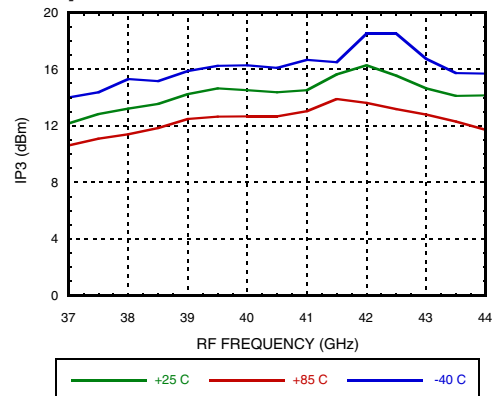

GaAs MMIC I/Q DOWNCONVERTER 37 - 44 GHz

Data Taken With Lower Sideband Selected, $T_A = 25^\circ\text{C}$, $IF = 2\text{ GHz}$, $RFIN = -26\text{ dBm}$, LO Drive = 3 dBm, Unless Otherwise Noted

Input IP3 vs. RF Frequency at Various LO Drives

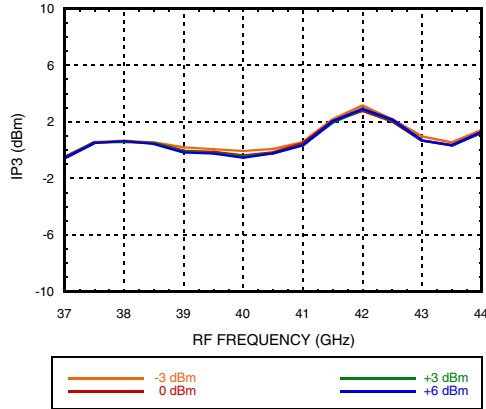

Output IP3 vs. RF Frequency at Various LO Drives

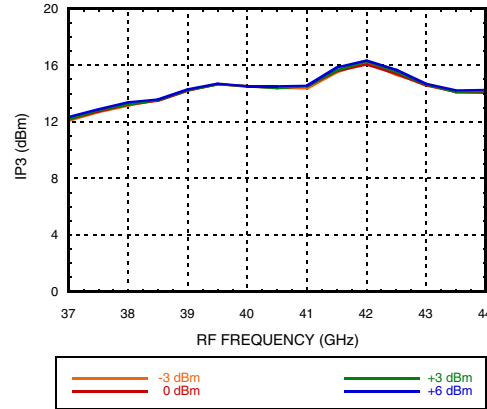

Input P1dB vs. RF Frequency over Temperature [1]

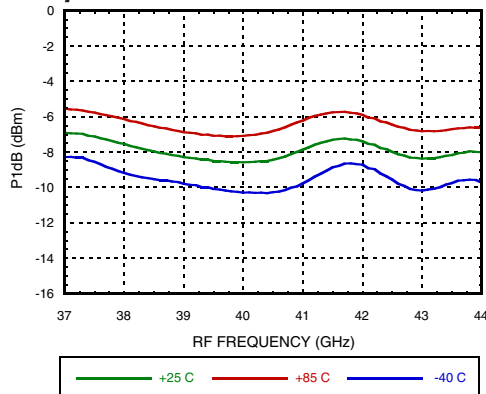

Output P1dB vs. RF Frequency over Temperature [1]

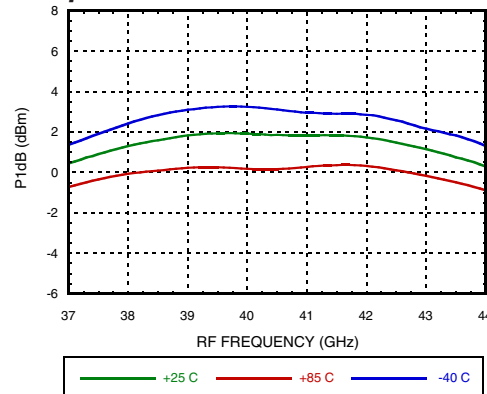

Noise Figure vs. RF Frequency over Temperature

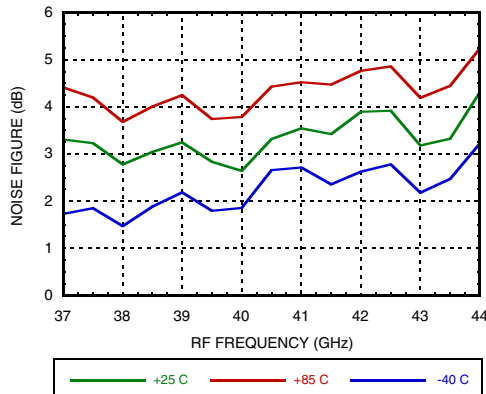

Noise Figure vs. RF Frequency at Various LO Drives

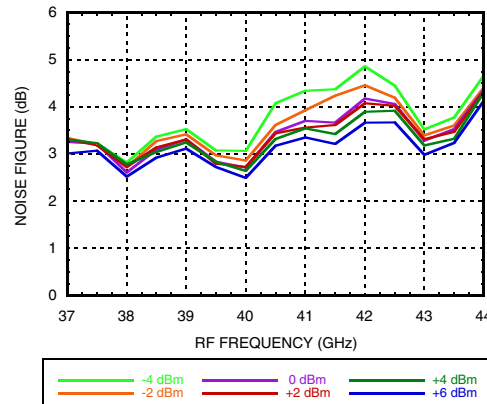

[1] Not compensated for board loss and hybrid loss

GaAs MMIC I/Q DOWNCONVERTER 37 - 44 GHz

Data Taken With Lower Sideband Selected, $T_A = 25^\circ\text{C}$, $IF = 1\text{ GHz}$, $RFIN = -26\text{ dBm}$, LO Drive = 3 dBm , Unless Otherwise Noted

Conversion Gain vs. RF Frequency over Temperature

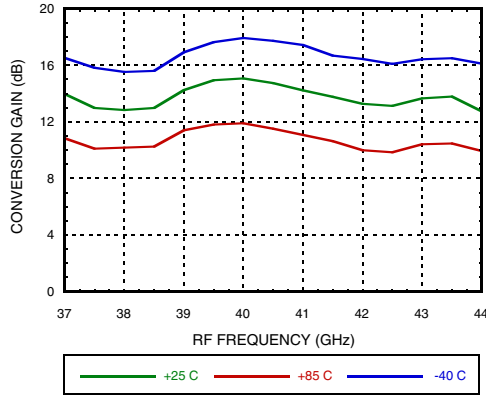

Conversion Gain vs. RF Frequency at Various LO Drives

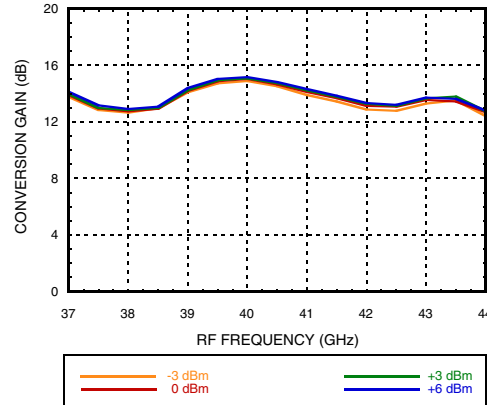

Image Rejection vs. RF Frequency over Temperature

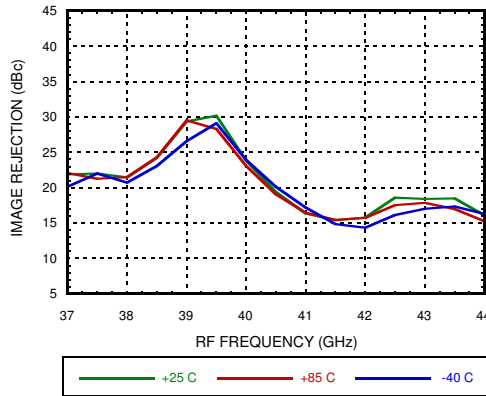
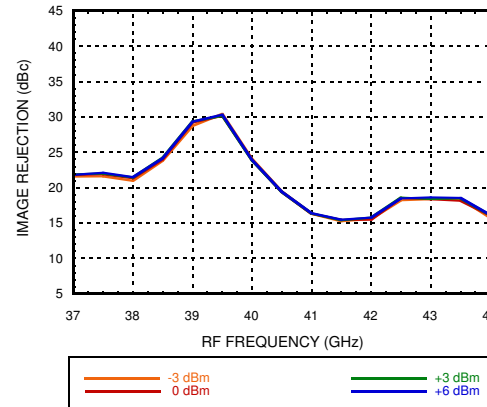
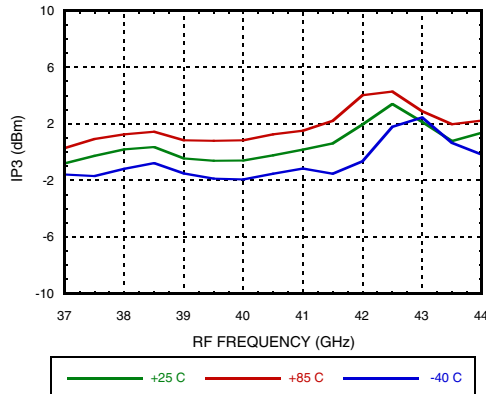

Image Rejection vs. RF Frequency at Various LO Drives



Input IP3 vs. RF Frequency over Temperature



Output IP3 vs. RF Frequency over Temperature

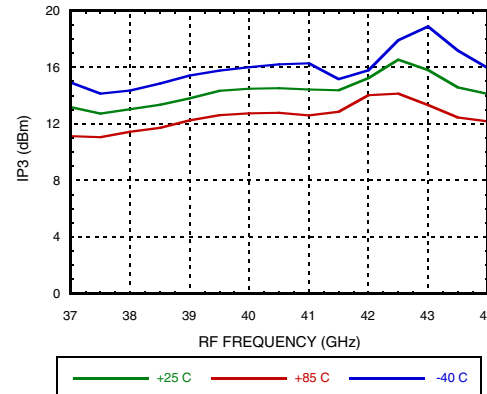

GaAs MMIC I/Q DOWNCONVERTER
37 - 44 GHz

Data Taken With Lower Sideband Selected, $T_A = 25^\circ\text{C}$, $IF = 1\text{ GHz}$, $RFIN = -26\text{ dBm}$, LO Drive = 3 dBm, Unless Otherwise Noted

Input IP3 vs. RF Frequency at Various LO Drives

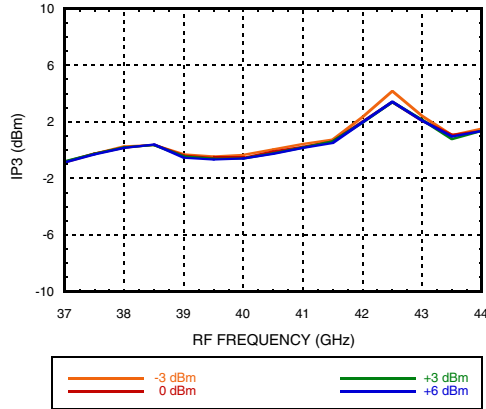

Output IP3 vs. RF Frequency at Various LO Drives

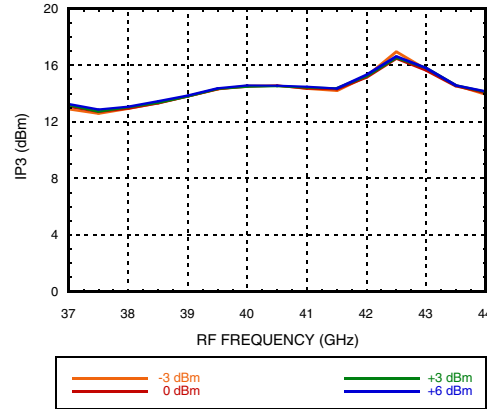

Input P1dB vs. RF Frequency over Temperature [1]

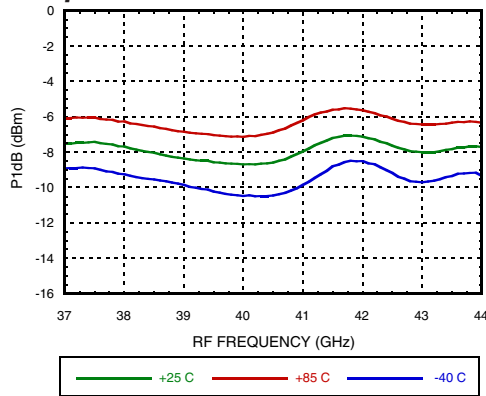

Output P1dB vs. RF Frequency over Temperature [1]

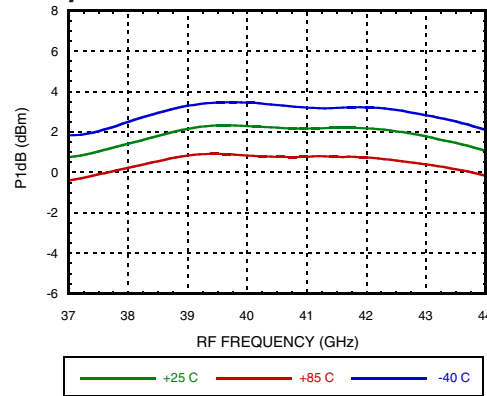

Noise Figure vs. RF Frequency over Temperature, LO Drive = 4 dBm

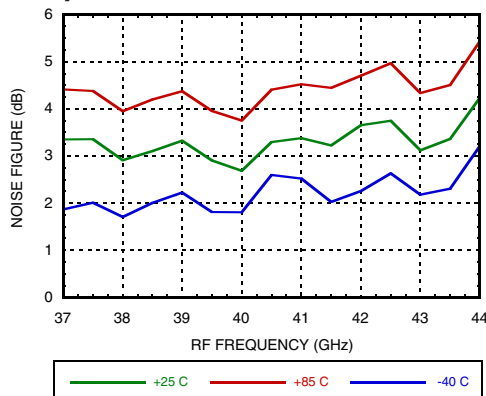

Noise Figure vs. RF Frequency at Various LO Drives

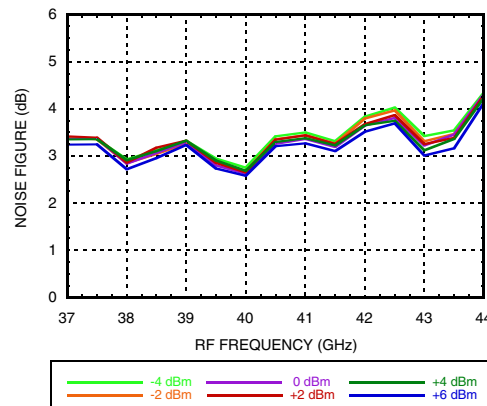

[1] Not compensated for board loss and hybrid loss

**GaAs MMIC I/Q DOWNCONVERTER
37 - 44 GHz**

Data Taken With Lower Sideband Selected, $T_A = 25^\circ\text{C}$, $IF = 1\text{ GHz}$, $R_{FIN} = -26\text{ dBm}$, LO Drive = 3 dBm , Unless Otherwise Noted

Amplitude Balance vs. RF Frequency over Temperature

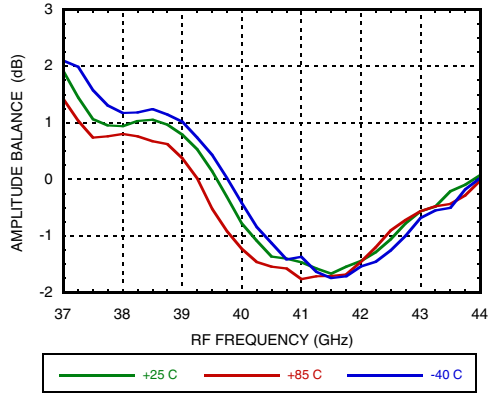

Amplitude Balance vs. RF Frequency at Various LO Drives

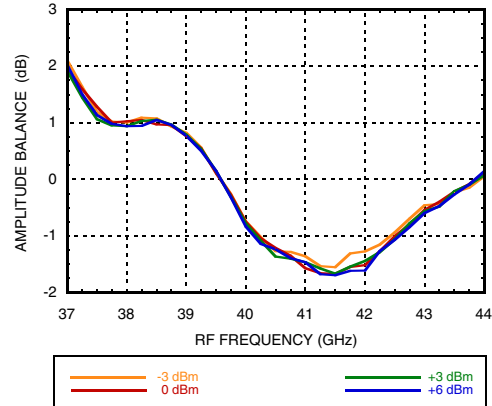

Phase Balance vs. RF Frequency over Temperature

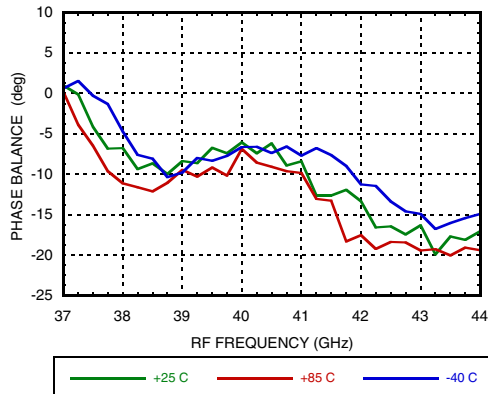

Phase Balance vs. RF Frequency at Various LO Drives

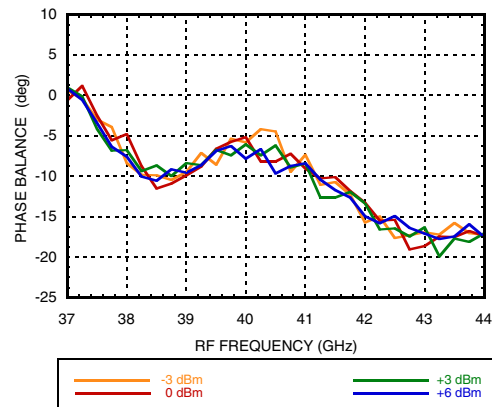

GaAs MMIC I/Q DOWNCONVERTER 37 - 44 GHz

Absolute Maximum Ratings

RF Input	+8 dBm
LO Input	+10 dBm
Bias Voltage, VDLO and VDRF	+3.5 V
Channel Temperature	175 °C
Continuous P _{diss} (T = 85°C) (derate 17.8 mW/°C above 85°C)	1.6 W
Thermal Resistance (channel to ground paddle)	56 °C/W
Storage Temperature	-65 to +150 °C
Operating Temperature	-40 to +85 °C
ESD Sensitivity (HBM)	250 V (Class 1A)



**ELECTROSTATIC SENSITIVE DEVICE
OBSERVE HANDLING PRECAUTIONS**

Outline Drawing

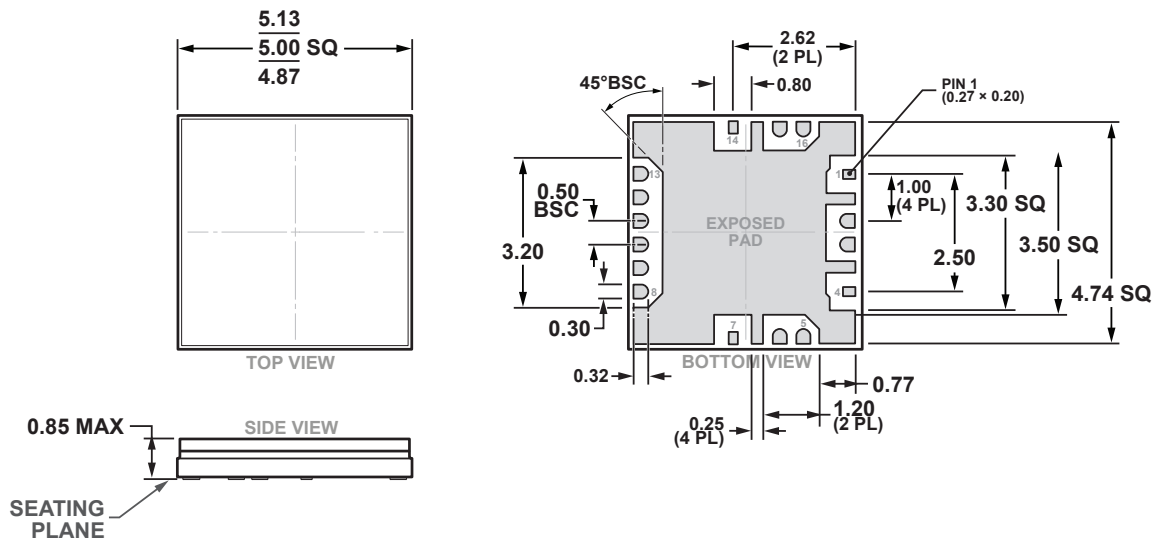

PVG-004832

05-07-2016-A

Package Information

Part Number	Package Body Material	Lead Finish	MSL Rating [2]	Package Marking [1]
HMC6789BLC5A	Alumina, White	Gold over Nickel	MSL3	H6789B XXXX

[1] 4-Digit lot number XXXX

[2] Max peak reflow temperature of 260 °C

GaAs MMIC I/Q DOWNCONVERTER 37 - 44 GHz

Pin Descriptions

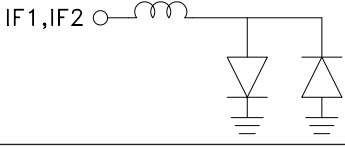
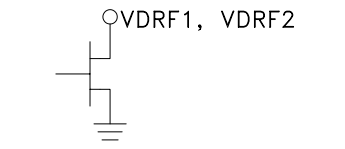
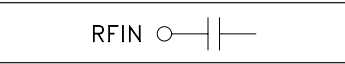
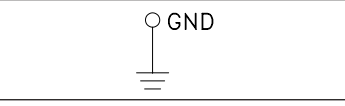
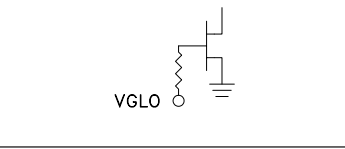
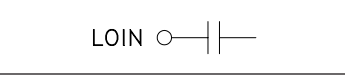
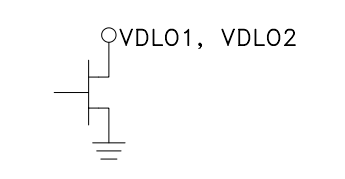
Pin Number	Function	Description	Interface Schematic
1, 4, 12, 15	N/C	No connection required. The pins are not connected internally; however, all data shown herein was measured with these pins connected to RF/DC ground externally.	
2	IF1	Quadrature IF Inputs. For applications not requiring operation to dc, use an off chip dc blocking capacitor. For operation to dc, these pins must not source/sink more than ± 3 mA of current or device malfunction and failure may result	
3	IF2		
5	VDRF1	Drain Voltage for the LNA. The recommended dc voltage is 3 V. Refer to application circuit for required external components.	
6	VDRF2		
7	RFIN	This pin is ac-coupled and matched to 50 Ohms.	
8, 11, 16	GND	These pins and exposed ground paddle must be connected to RF/dc ground.	
9	VGLO	Gate Voltage for the Local Oscillator. Adjust VGLO for -2 V to 0 V to set the multiplier quiescent current to 150mA. Refer to application circuit for required external components.	
10	LOIN	LO Input Port. The recommended LO Power is -3 to 6 dBm.	
13	VDLO1	Drain Voltage for Multiplier input Buffer Amp. The recommended dc voltage is 3 V. Refer to application circuit for required external components.	
14	VDLO2		

GaAs MMIC I/Q DOWNCONVERTER 37 - 44 GHz

Application Circuit

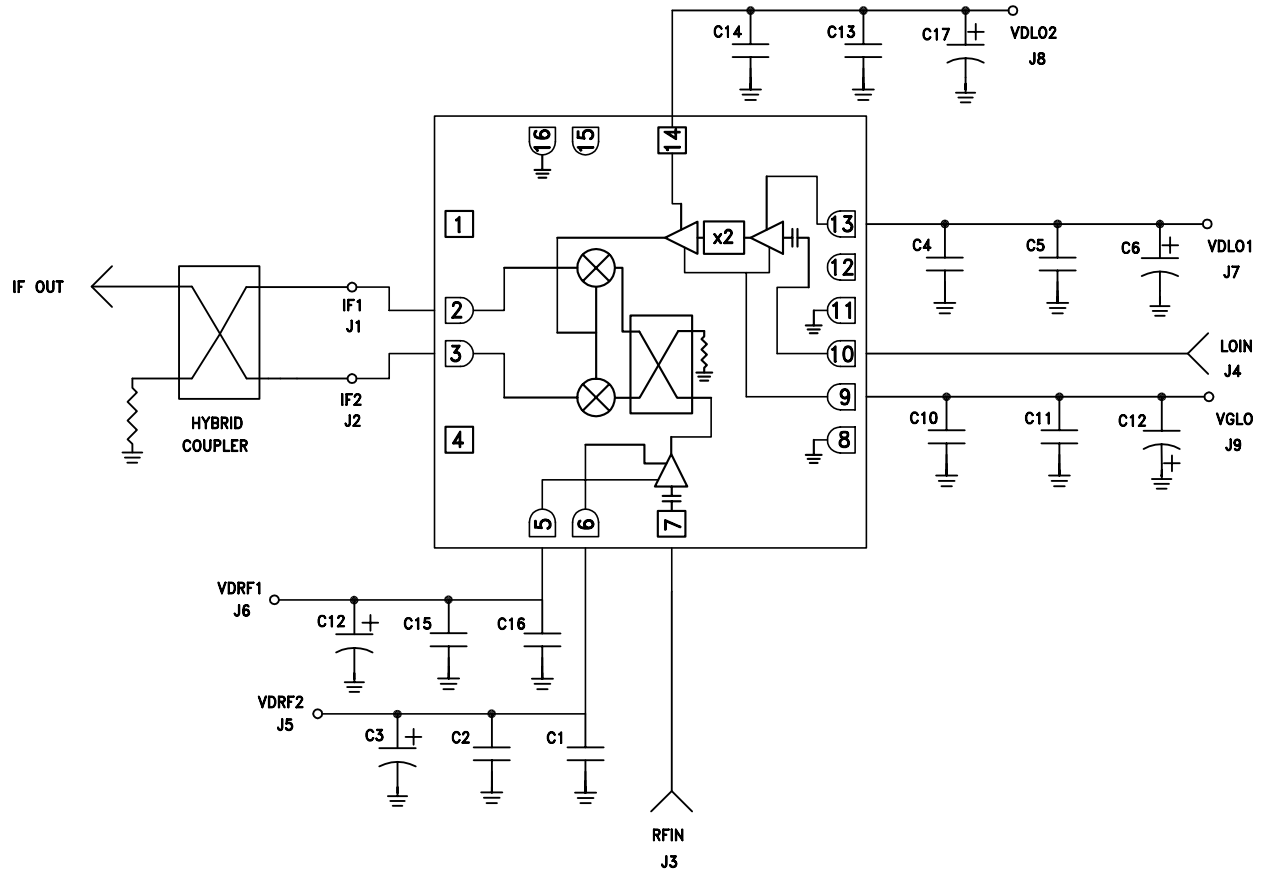

C1, C4, C10, C14, C16	100 pF Capacitor, 0402 Pkg.
C2, C5, C11, C13, C15	0.1µF Capacitor, 0402 Pkg.
C3, C6, C12, C17, C19	4.7 µF Capacitor, Case A Pkg.

Evaluation PCB

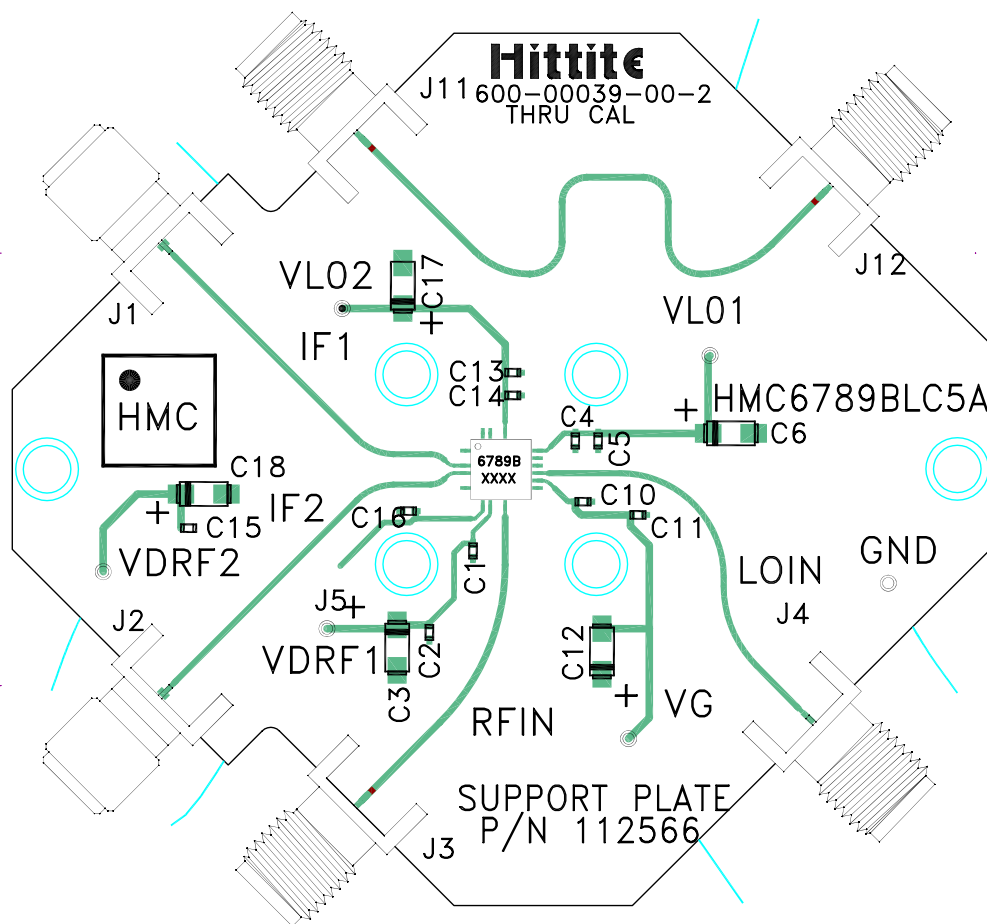

Evaluation Order Information

Item	Contents	Part Number
Evaluation PCB Only	Evaluation PCB Assembly	EV1HMC6789BLC5A ^[1] ^[2]

[1] Reference this number when ordering Evaluation PCB Only.
 [2] Heatsink is required for proper operation.

List of Materials for Evaluation PCB EV1HMC6789BLC5A

Item	Description
J1, J2	SMA Connector, SRI
J3, J4, J11, J12	K Connector, SRI
C1, C4, C10, C14, C16	100 pF Capacitor, 0402 Pkg.
C2, C5, C11, C13, C15	0.1 μF Capacitor, 0402 Pkg.
C3, C6, C12, C17, C18	4.7 μF Capacitor, Case A
U1	HMC6789BLC5A Downconverter
PCB ^[1]	600-00039-00 A/H PCB

[1] Circuit Board Material: Arlon 25FR, FR4 or Rogers 4350

The circuit board used in the application should use RF circuit design techniques. Signal lines should have 50 Ohm impedance while the package ground leads and exposed paddle should be connected directly to the ground plane similar to that shown. A sufficient number of via holes should be used to connect the top and bottom ground planes. The evaluation circuit board shown is available from Analog Devices upon request.