



## 14 Gbps, FAST RISE TIME D-TYPE FLIP-FLOP

### Typical Applications

The HMC727LC3C is ideal for:

- 16 G Fiber Channel
- RF ATE Applications
- Broadband Test & Measurement
- Serial Data Transmission up to 14 Gbps
- Digital Logic Systems up to 14 GHz

### Features

- Supports High Data Rates: up to 14 Gbps
- Differential or Single-Ended Operation
- Fast Rise and Fall Times: 19 / 17 ps
- Low Power Consumption: 260 mW typ.
- Propagation Delay: 105 ps
- Single Supply: -3.3 V
- 16 Lead Ceramic 3x3 mm SMT Package: 9 mm<sup>2</sup>

### Functional Diagram

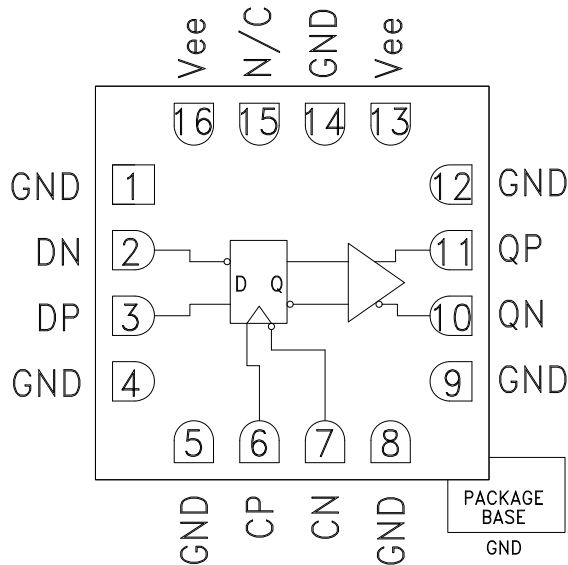

### General Description

The HMC727LC3C is a D-Type Flip-Flop designed to support data transmission rates of up to 14 Gbps, and clock frequencies as high as 14 GHz. During normal operation, data is transferred to the outputs on the positive edge of the clock. Reversing the clock inputs allows for negative-edge triggered applications.

All differential inputs to the HMC727LC3C are CML and terminated on-chip with 50 Ohms to the positive supply, GND, and may be DC or AC coupled. The differential CML outputs are source terminated to 50 Ohms and may also be AC or DC coupled. Outputs can be connected directly to a 50 Ohm ground-terminated system or drive devices with CML logic input. The HMC727LC3C operates from a single -3.3 V supply and is available in ROHS-compliant 3x3 mm SMT package.

### Electrical Specifications, $T_A = +25\text{ }^\circ\text{C}$ , $V_{ee} = -3.3\text{ V}$

Parameter	Conditions	Min.	Typ.	Max	Units
Power Supply Voltage		-3.6	-3.3	-3.0	V
Power Supply Current			80		mA
Maximum Data Rate			14		Gbps
Maximum Clock Rate			14		GHz
Input Voltage Range		-1.5		0.5	V
Input Differential Range		0.1		2.0	Vp-p
Input Return Loss	Frequency <14 GHz		10		dB
Output Amplitude	Single-Ended, peak-to-peak		550		mVp-p
	Differential, peak-to-peak		1100		mVp-p
Output High Voltage			-10		mV
Output Low Voltage			-560		mV
Output Rise / Fall Time	Differential, 20% - 80%		19 / 17		ps

Information furnished by Analog Devices is believed to be accurate and reliable. However, no responsibility is assumed by Analog Devices for its use, nor for any infringements of patents or other rights of third parties that may result from its use. Specifications subject to change without notice. No license is granted by implication or otherwise under any patent or patent rights of Analog Devices. Trademarks and registered trademarks are the property of their respective owners.

For price, delivery, and to place orders: Analog Devices, Inc., One Technology Way, P.O. Box 9106, Norwood, MA 02062-9106  
Phone: 781-329-4700 • Order online at [www.analog.com](http://www.analog.com)  
Application Support: Phone: 1-800-ANALOG-D



## 14 Gbps, FAST RISE TIME D-TYPE FLIP-FLOP

### Electrical Specifications (continued)

Parameter	Conditions	Min.	Typ.	Max	Units
Output Return Loss	Frequency <14 GHz		10		dB
Random Jitter Jr	rms			0.2	ps rms
Deterministic Jitter, Jd	peak-to-peak, 2 <sup>15</sup> -1 PRBS input [1]		2		ps, p-p
Propagation Delay Clock to Data, td			105		ps
Clock Phase Margin	13 GHz		320		deg
Set Up & Hold Time, t <sub>SH</sub>			6		ps

[1] Deterministic jitter calculated by simultaneously measuring the jitter of a 300 mV, 13 GHz, 2<sup>15</sup>-1 PRBS input, and a single-ended output

#### DC Current vs. Supply Voltage [1]

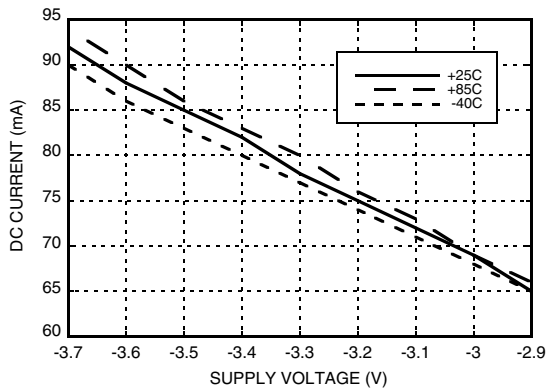

#### Output Differential Voltage vs. Supply Voltage [2]

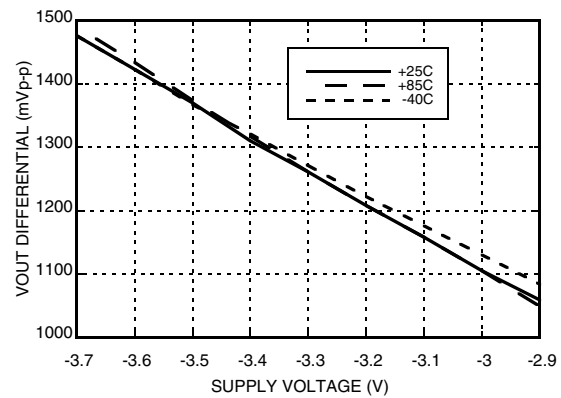

#### Rise / Fall Time vs. Supply [1]

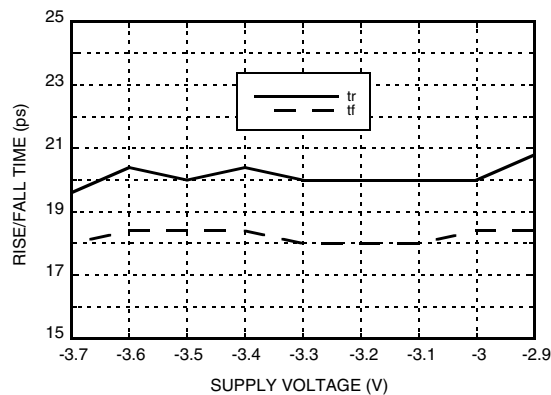

[1] Data rate = 13 Gbps

[2] Frequency = 10 GHz

[3] Vee = -3.3 V



**14 Gbps, FAST RISE TIME  
D-TYPE FLIP-FLOP**

**Output Return Loss vs. Frequency**

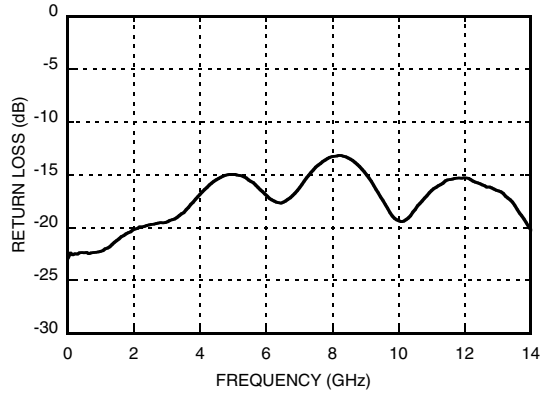

**Input Return Loss vs. Frequency**

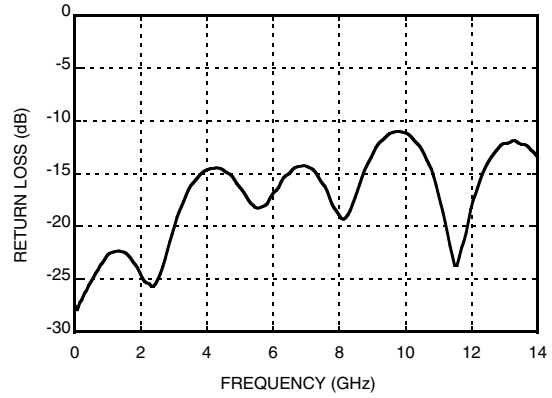



**14 Gbps, FAST RISE TIME  
D-TYPE FLIP-FLOP**

**Eye Diagram**

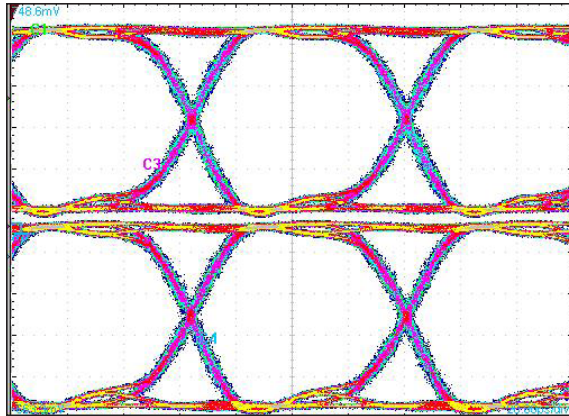

[1] Test Conditions:  
 Pattern generated with an Agilent N4903A Serial BERT.  
 Eye Diagram presented on a Tektronix CSA 8000.  
 Device input = 13 Gbps PN code, Vin = 300 mVp-p differential.  
 Both output channels shown.

**Timing Diagram**

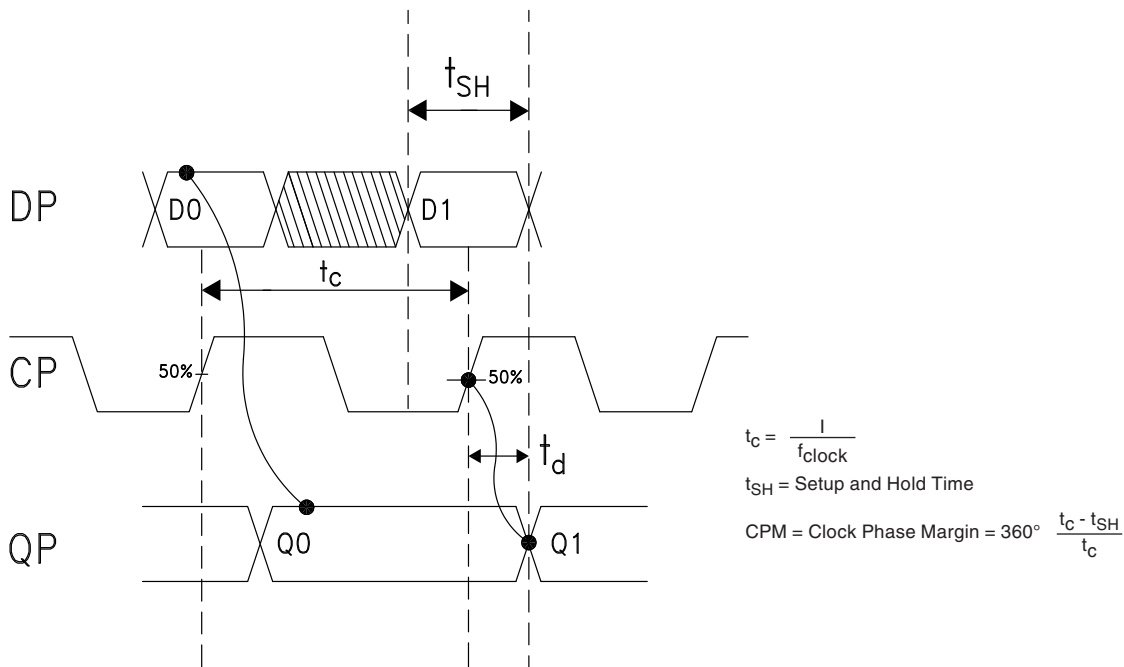

**Truth Table**

Input		Outputs
D	C	Q
L	L -> H	L
H	L -> H	H

Notes:  
 D = DP - DN  
 C = CP - CN  
 Q = QP - QN  
 H - Positive voltage level  
 L - Negative voltage level



## 14 Gbps, FAST RISE TIME D-TYPE FLIP-FLOP

### Absolute Maximum Ratings

Power Supply Voltage (Vee)	-3.75 V to +0.5 V
Input Signals	-2 V to +0.5 V
Output Signals	-1.5 V to +1 V
Continuous Pdiss (T = 85 °C) (derate 17 mW/°C above 85 °C)	0.68 W
Thermal Resistance (R <sub>th j-p</sub> ) Worst case junction to package paddle	59 °C/W
Maximum Junction Temperature	125 °C
Storage Temperature	-65 °C to +150 °C
Operating Temperature	-40 °C to +85 °C
ESD Sensitivity (HBM)	Class 1C



ELECTROSTATIC SENSITIVE DEVICE  
OBSERVE HANDLING PRECAUTIONS

### Outline Drawing

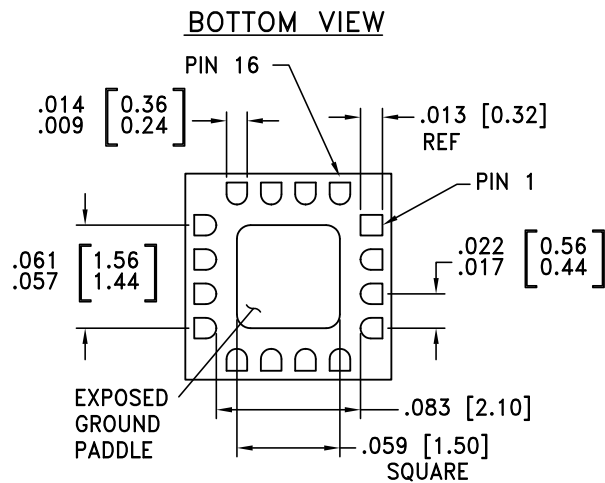
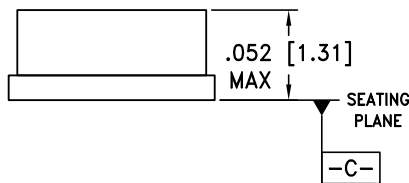
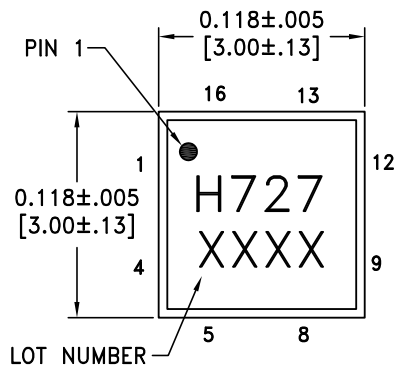

NOTES:

1. PACKAGE BODY MATERIAL: ALUMINA
2. LEAD AND GROUND PADDLE PLATING:  
30-80 MICROINCHES GOLD OVER 50 MICROINCHES MINIMUM NICKEL.
3. DIMENSIONS ARE IN INCHES [MILLIMETERS].
4. LEAD SPACING TOLERANCE IS NON-CUMULATIVE.
5. PACKAGE WARP SHALL NOT EXCEED 0.05 mm DATUM -C-
6. ALL GROUND LEADS MUST BE SOLDERED TO PCB RF GROUND.
7. PADDLE MUST BE SOLDERED TO GND.



### Package Information

Part Number	Package Body Material	Lead Finish	MSL Rating	Package Marking <sup>[2]</sup>
HMC727LC3C	Alumina, White	Gold over Nickel	MSL3 <sup>[1]</sup>	H727 XXXX

[1] Max peak reflow temperature of 260 °C

[2] 4-Digit lot number XXXX

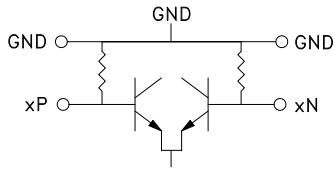
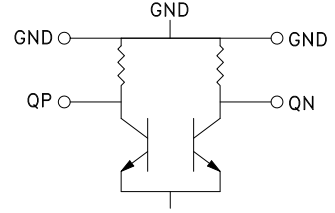
**14 Gbps, FAST RISE TIME  
D-TYPE FLIP-FLOP**
**Pin Descriptions**

Pin Number	Function	Description	Interface Schematic
1, 4, 5, 8, 9, 12	GND	Signal Grounds	
2, 3 6, 7	DN, DP CP, CN	Differential Data Inputs: Common Mode Logic (CML) referenced to positive supply.	
10, 11	QN, QP	Differential Data Outputs: Common Mode Logic (CML) referenced to positive supply.	
13, 16	Vee	Negative Supply	
14, Package Base	G	GND	
15	N/C	No Connection required. This pin may be connected to RF/DC ground without affecting performance.	

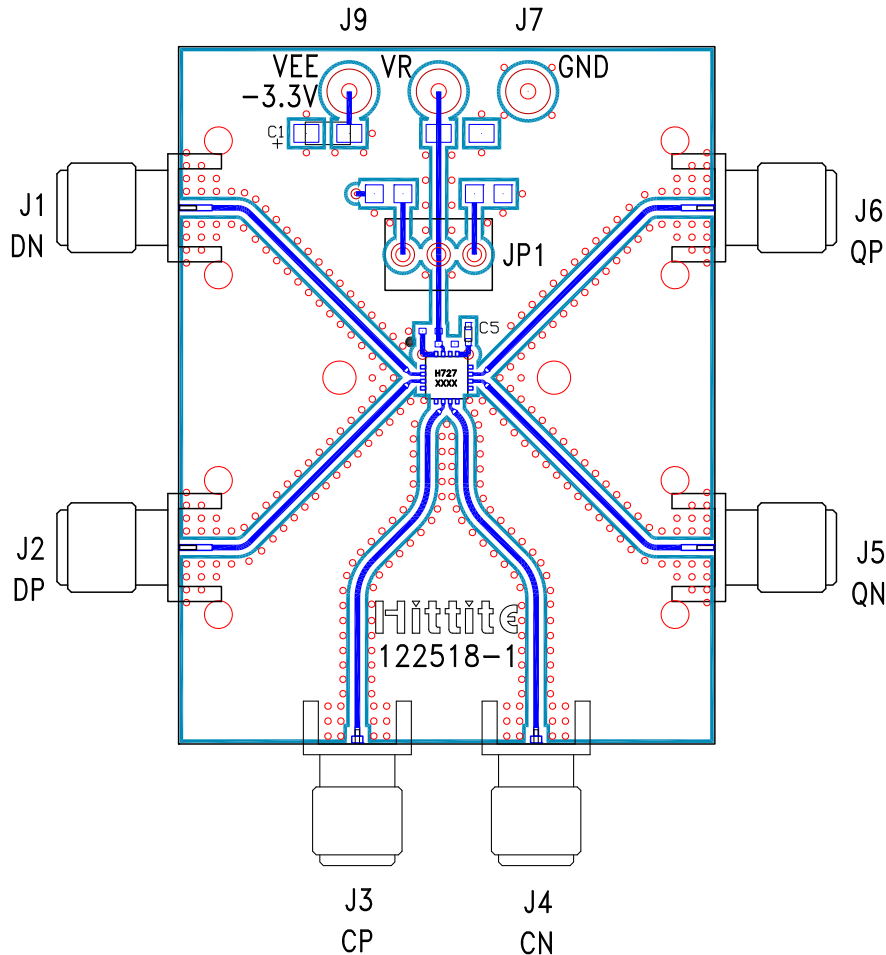
**14 Gbps, FAST RISE TIME  
D-TYPE FLIP-FLOP**
**Evaluation PCB**

**List of Materials for Evaluation PCB 122520 [1]**

Item	Description
J1 - J6	PCB Mount SMA RF Connectors
J7, J9	DC Pin
C1	4.7 $\mu$ F Capacitor, Tantalum
C5	100 pF Capacitor, 0402 Pkg.
U1	HMC727LC3C High Speed Logic, D-Type Flip-Flop
PCB [2]	122518 Evaluation Board

[1] Reference this number when ordering complete evaluation PCB

[2] Circuit Board Material: Arlon 25FR or Rogers 4350

The circuit board used in the application should use RF circuit design techniques. Signal lines should have 50 Ohm impedance while the package ground leads should be connected directly to the ground plane similar to that shown. The exposed package base should be connected to GND. A sufficient number of via holes should be used to connect the top and bottom ground planes. The evaluation circuit board shown is available from Hittite upon request.