

WIDEBAND 4 GS/S TRACK-AND-HOLD AMPLIFIER DC - 5 GHz



Typical Applications

The HMC760LC4B is ideal for:

- RF ATE Applications
- Digital Sampling Oscilloscopes
- RF Demodulation Systems
- Digital Receiver Systems
- High Speed Peak Detectors
- Software Defined Radio
- Radar, ECM & ELINT Systems
- High Speed DAC De-Glitching

Features

- 5 GHz Input bandwidth (1 Vp-p Full Scale)
- 4 GS/s Maximum Sampling Rate
- ≥ 66 dB SFDR
(0 to 5 GHz / 0.5 Vp-p Input, CLK = 1 GS/s)
- ≥ 56 dB SFDR
(0 to 5 GHz / 1 Vp-p Input, CLK = 1 GS/s)
- Direct-Coupled I/O
- Ultra-Clean Output Waveforms, Minimal Glitching
- >60 dB Hold Mode Feedthrough Rejection
- 0.9 mV RMS Hold Mode Output Noise
- RoHS Compliant 4x4 mm SMT Package

Functional Diagram

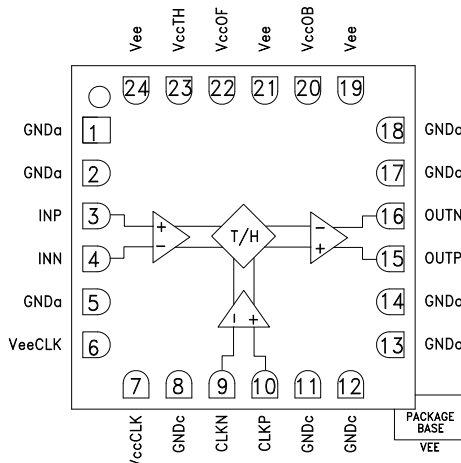

General Description

The HMC760LC4B is a SiGe monolithic, fully differential, single rank, track-and-hold (T/H) that provides unprecedented bandwidth and dynamic-range performance to wideband sampled signal systems. The T/H offers precision signal sampling over 5 GHz bandwidth, with 9 to 10-bit linearity from DC to 5 GHz input frequency, 0.9 mV noise, and <70 fs random aperture jitter. The device can be clocked to 4 GS/s with minimal dynamic range loss. The T/H can be used to expand the bandwidth and/or high-frequency linearity of high-speed A/D conversion and signal acquisition systems.

Electrical Specifications $T_A = +25\text{ }^\circ\text{C}$, See Test Conditions on following page herein.

Parameter	Conditions	Test Level	Min.	Typ.	Max.	Units
Analog Inputs (INP, INN)						
Differential Full Scale Range	Full-scale input for linearity test	1		1		Vpp
Input Resistance	Each lead to ground	3		50		Ω
Return Loss	0 to 6 GHz	3		19		dB
Input Common Mode Voltage		3	-0.1	0	0.1	V
Clock Inputs (CLKP, CLKN)						
DC Differential Clock High Voltage (Track Mode)		3	20	40	2000	mV
DC Differential Clock Low Voltage (Hold Mode)		3	-2000	-40	-20	mV
Amplitude (Sinusoidal Input)	Per Port	2	-6	0	10	dBm
Input Common Mode Voltage		3	-0.5	0	0.5	V
Clock Slew Rate	Recommended for best linearity	3		2 - 4		V/ns
Return Loss	0 to 5 GHz	3		18		dB
Input Resistance	Each Lead to Ground	3		50		Ω

Information furnished by Analog Devices is believed to be accurate and reliable. However, no responsibility is assumed by Analog Devices for its use, nor for any infringements of patents or other rights of third parties that may result from its use. Specifications subject to change without notice. No license is granted by implication or otherwise under any patent or patent rights of Analog Devices. Trademarks and registered trademarks are the property of their respective owners.

For price, delivery, and to place orders: Analog Devices, Inc., One Technology Way, P.O. Box 9106, Norwood, MA 02062-9106 Phone: 781-329-4700 • Order online at www.analog.com Application Support: Phone: 1-800-ANALOG-D

WIDEBAND 4 GS/S TRACK-AND-HOLD AMPLIFIER DC - 5 GHz



Electrical Specifications (continued)

Parameter	Conditions	Test Level	Min.	Typ.	Max.	Units
Analog Outputs (OUTP, OUTN)						
Differential Full Scale Range		4		1		Vp-p
Common Mode Output Voltage		4		0		V
Output Impedance	Per Port	3		50		Ω
Return Loss	0 to 5 GHz	3		14		dB
Track Mode Dynamics						
Baseband Gain		1	-1.5	0	0.5	dB
Track Mode Bandwidth	@ 1 Vp-p Input	4		4		GHz
Integrated Noise ^[2]		3		0.7		mV RMS
Hold Mode Dynamics						
Sampling Bandwidth	@ -3 dB Gain, 1 Vp-p Input Level	3		5		GHz
Differential Droop Rate (Linear Component)		1		-1.3		%/ns
Differential Droop Rate Magnitude (Fixed Component)		1		2		mV/ns
Feedthrough Rejection	@ 3 GHz	3		≥60		dB
Integrated Noise ^[2]	500 MHz Clock Frequency	3		0.86		mV RMS
Maximum Hold Time		3		2		ns
Single Tone THD/SFDR @ 0.995 GHz	Full Scale Input (1 Vp-p) ^{[1][3]}	1		-57 / 57		dB
Single Tone THD/SFDR @ 1.995 GHz	Full Scale Input (1 Vp-p) ^[1]	3		-56 / 56		dB
Single Tone THD/SFDR @ 2.995 GHz	Full Scale Input (1 Vp-p) ^[1]	3		-59 / 60		dB
Single Tone THD/SFDR @ 3.995 GHz	Full Scale Input (1 Vp-p) ^{[1][3]}	1		-63 / 64		dB
Single Tone THD/SFDR @ 4.995 GHz	Full Scale Input (1 Vp-p) ^[1]	3		-60 / 62		dB
Single Tone THD/SFDR @ 0.995 GHz	Half Full Scale Input (0.5 Vp-p) ^[1]	3		-65 / 67		dB
Single Tone THD/SFDR @ 1.995 GHz	Half Full Scale Input (0.5 Vp-p) ^[1]	3		-64 / 67		dB
Single Tone THD/SFDR @ 2.995 GHz	Half Full Scale Input (0.5 Vp-p) ^[1]	3		-65 / 68		dB
Single Tone THD/SFDR @ 3.995 GHz	Half Full Scale Input (0.5 Vp-p) ^[1]	3		-65 / 68		dB
Single Tone THD/SFDR @ 4.995 GHz	Half Full Scale Input (0.5 Vp-p) ^[1]	3		-63 / 66		dB
Track-to-Hold & Hold-and-Track Switching						
Aperture Delay	Simulated Value			-6		ps
Random Aperture Jitter	Full-scale Input @ 1 GHz ^[1]	3		<70		fs
Differential Pedestal (Linear Component)	1 GHz Clock Frequency, 6 dBm Clock Power	3		0.15		%
Differential Pedestal Magnitude (Fixed Component),		3		1.6		mV
Clock Frequency	@ 50% Duty Cycle	3	250		4000	MHz
Clock Buffer Pipeline Delay	Simulated Value			35		ps
Acquisition Time to 1 mV	Simulated Value			290		ps
Settling Time to 1 mV	Simulated Value			116		ps

[1] 1 GS/s Clock, Clock Power = 6 dBm / input terminal.

[3] Production tested @ 500 MS/s Clock, Clock Power = 10 dBm

[2] Noise bandwidth limited by output amplifier bandwidth of ~7 GHz.

WIDEBAND 4 GS/S TRACK-AND-HOLD AMPLIFIER DC - 5 GHz



Electrical Specifications (continued)

Parameter	Conditions	Test Level	Min.	Typ.	Max.	Units
Power Supply Requirements						
VccTH Voltage			1.9	2	2.1	V
VccTH Current		1		62		mA
VccOF Voltage			1.9	2	2.1	V
VccOF Current		1		39		mA
VccOB Voltage			1.9	2	2.1	V
VccOB Current		1		72		mA
VccCLK Voltage			1.9	2	2.1	V
VccCLK Current		1		25		mA
Vee Voltage			-5	-4.75	-4.5	V
(Vee + VeeCLK) Current		1		-216		mA
Power Consumption		1		1.42		W

Test Levels

- 100% production tested at $T_A = +25^\circ\text{C}$
- Guaranteed by design/characterization testing
- Characterization Sample Tested
- Typical value only

Sampling Transfer Function

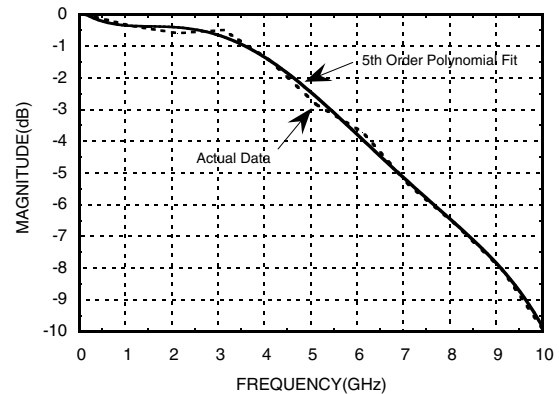

Time Domain Output Waveform

@ $f_{clk} = 500\text{ MHz}$, $f_{in} = 1.125\text{ GHz}$

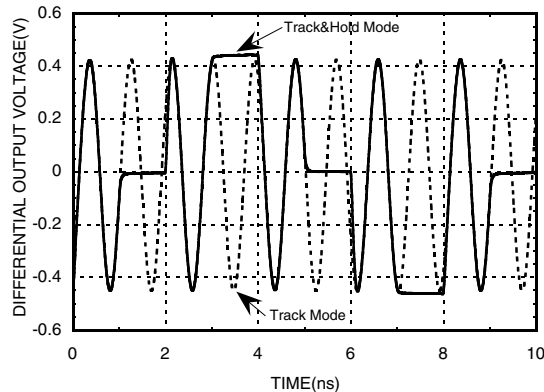

Time Domain Output Waveform

@ $f_{clk} = 500\text{ MHz}$, $f_{in} = 4.125\text{ GHz}$

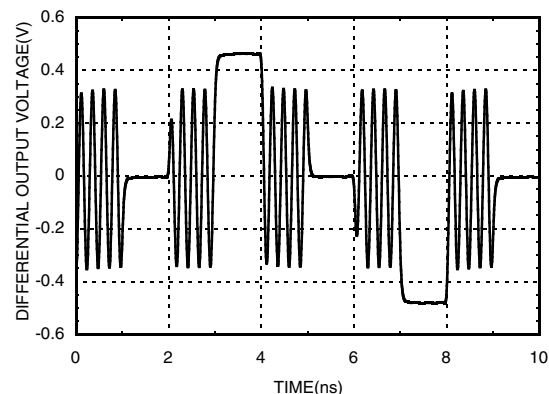

**WIDEBAND 4 GS/S TRACK-AND-HOLD AMPLIFIER
DC - 5 GHz**



**Hold-Mode SFDR vs. Frequency
& Input Power @ $f_{clk} = 500 \text{ MHz} @ +10 \text{ dBm}$**

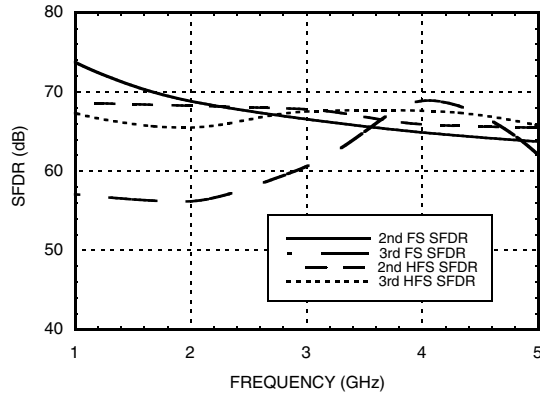

**Hold-Mode THD vs. Frequency
& Input Power @ $f_{clk} = 500 \text{ MHz} @ +10 \text{ dBm}$**

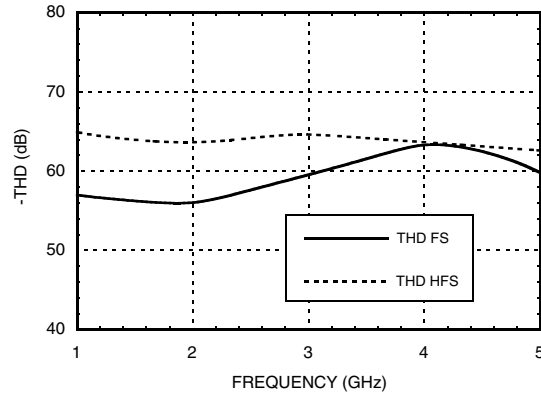

**Hold-Mode SFDR vs. Frequency
& Input Power @ $f_{clk} = 1 \text{ GHz} @ +6 \text{ dBm}$**

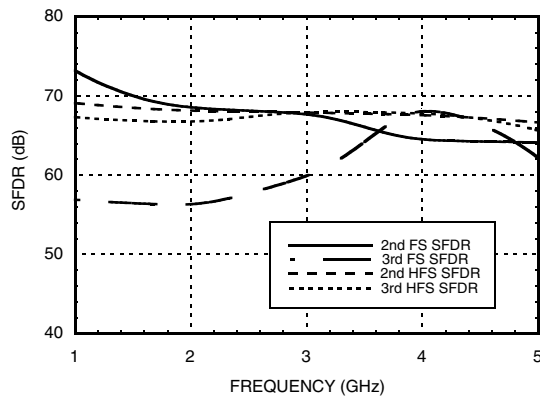

**Hold-Mode THD vs. Frequency
& Input Power @ $f_{clk} = 1 \text{ GHz} @ +6 \text{ dBm}$**

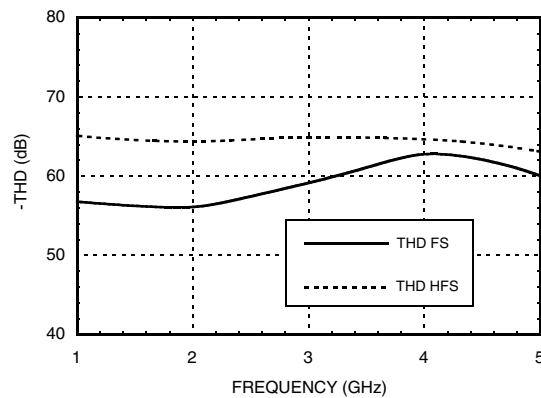

**Hold-Mode SFDR vs. Frequency
& Input Power @ $f_{clk} = 2 \text{ GHz} @ 0 \text{ dBm}$**

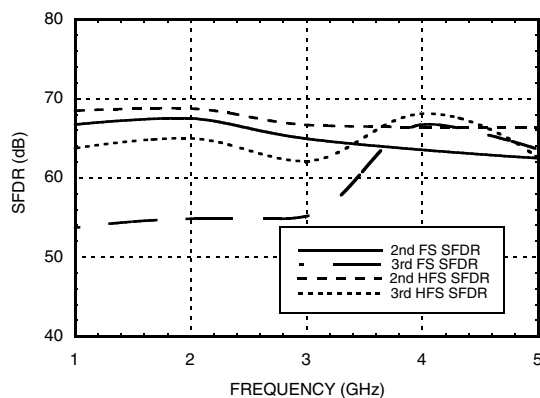

**Hold-Mode THD vs. Frequency
& Input Power @ $f_{clk} = 2 \text{ GHz} @ 0 \text{ dBm}$**

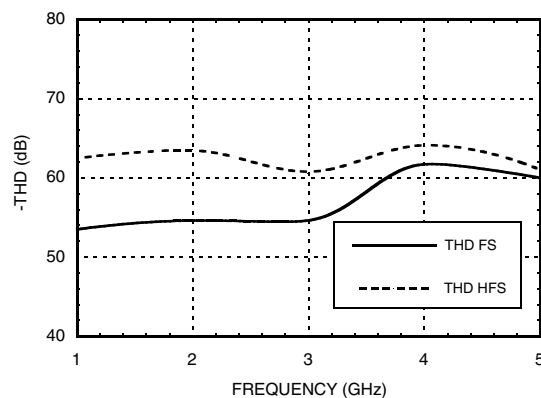

[1] FS = Full-Scale input level, HFS = Half-Full-Scale input level

[2] The measurement dynamic range for half-full-scale and full-scale inputs is about 68 dB and 74 dB, respectively, due to measurement noise floor limitations. Hence the measured spurious products tend to limit at these levels.

**WIDEBAND 4 GS/S TRACK-AND-HOLD AMPLIFIER
DC - 5 GHz**



**Hold-Mode SFDR vs. Frequency
& Input Power @ $f_{clk} = 3 \text{ GHz} @ 0 \text{ dBm}$**

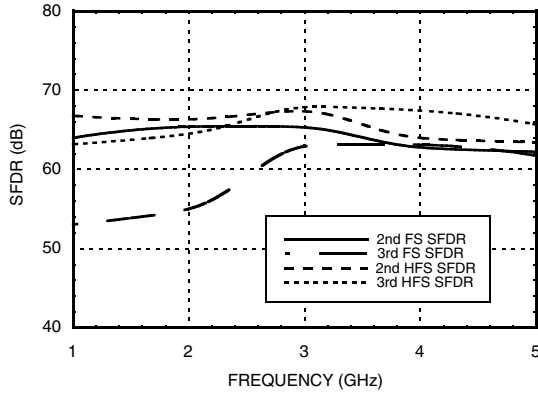

**Hold-Mode THD vs. Frequency
& Input Power @ $f_{clk} = 3 \text{ GHz} @ 0 \text{ dBm}$**

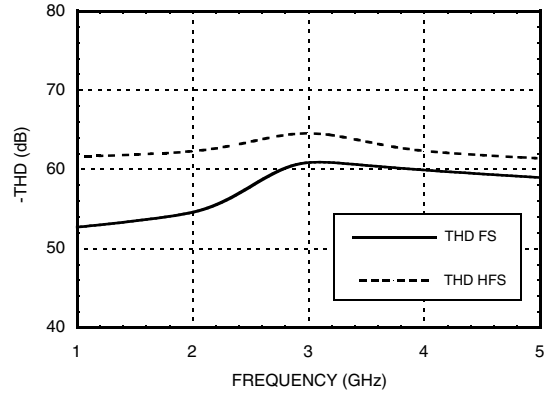

**Hold-Mode SFDR vs. Frequency
& Input Power @ $f_{clk} = 4 \text{ GHz} @ 0 \text{ dBm}$**

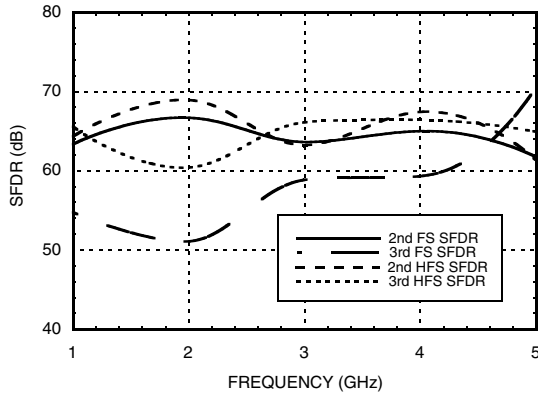

**Hold-Mode THD vs. Frequency
& Input Power @ $f_{clk} = 4 \text{ GHz} @ 0 \text{ dBm}$**

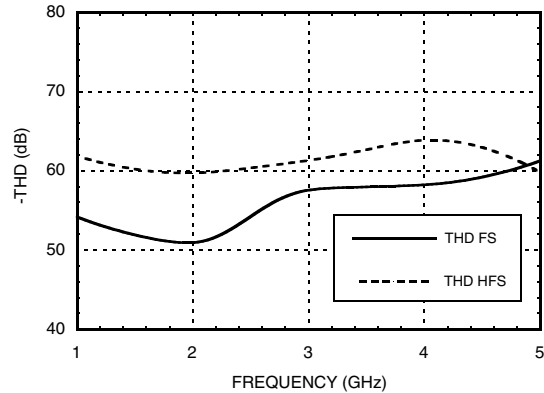

**Hold-Mode SFDR vs. Frequency & Clock
Power @ Full Scale Input Level (1 Vp-p),
 $f_{clk} = 500 \text{ MHz Sinusoid}$**

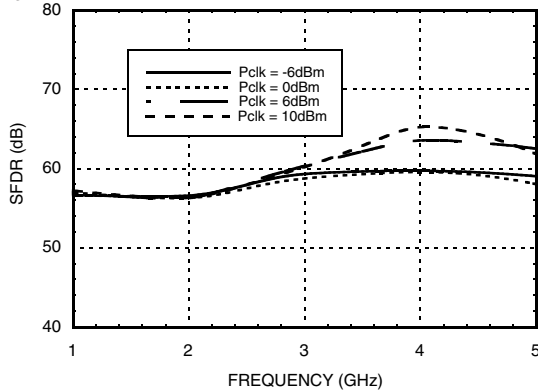

**Hold-Mode SFDR vs. Frequency & Clock
Power @ Full Scale Input Level (1 Vp-p),
 $f_{clk} = 1 \text{ GHz Sinusoid}$**

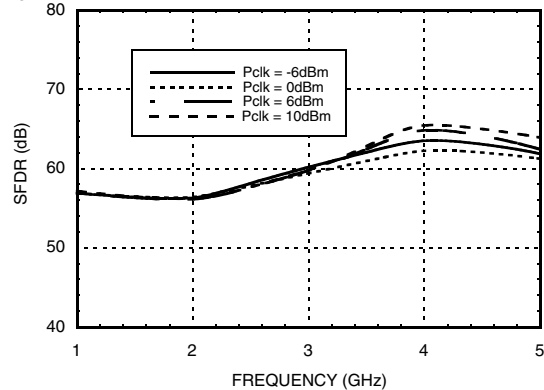

**WIDEBAND 4 GS/S TRACK-AND-HOLD AMPLIFIER
DC - 5 GHz****Definition of Specifications**

Aperture Delay: The delay of the exact sample time relative to the time that the hold command is applied to the device. It is the difference between the delay of the clock switching transition to the hold node and the input signal group delay to the hold node. If the input signal group delay to the hold node exceeds the clock delay this quantity can be negative.

Aperture Jitter: The standard deviation of the sample instant in time.

Acquisition Time: The interval between the internal hold-to-track transition and the time at which the hold-node signal is tracking the input signal within a specified accuracy. It does not include the pipeline delay of the clock buffer.

Differential Pedestal: A component in the sample value caused by charge redistribution in the T/H switch during the sampling transition. In general, the pedestal can consist of three components: a fixed offset, a component that is linearly related to input signal amplitude, and a component that is nonlinearly related to input signal amplitude. The majority of the pedestal is usually linear. The value of the pedestal can be approximated by

$$P = P_o + P_{lin} V_{in}$$

where, P_o is the fixed pedestal component, P_{lin} is the linear pedestal component, and V_{in} is the sampled signal level.

Differential Droop Rate: The slow drift in the differential output voltage of a held sample while the T/H is in hold-mode. It is typically caused by current leakage on the hold capacitors and corresponds to a decay in the held voltage with increasing time. The droop can be approximated as the sum of a fixed component and a component that is linearly related to the held sample voltage. The total droop can be approximated by $D = D_o + D_{lin} V_{in}$ where D_o is the fixed component, D_{lin} is the linear droop constant and V_{in} is the sampled signal level. The sign of D_o tends to be random so only the magnitude is specified. Since the droop is mostly linear, it causes little nonlinearity.

Feedthrough Rejection: A measure of the off-state (hold-mode) isolation of the T/H's internal switch. It is defined as the ratio of the amplitude of the output signal (for a sinusoidal input) feeding through during the hold mode to the amplitude of the output signal during track mode. Normalization by the track-mode signal gives the true switch isolation without the effects of the output amplifier bandwidth limiting.

Full Scale Range: The voltage range between the minimum and maximum signal levels that can be handled by the T/H while still meeting the specifications.

Sampling Bandwidth: The -3 dB bandwidth of the sampled signal levels represented by the held sample amplitudes. It includes both the bandwidth of the transfer function from the signal input to the hold-node and any band-limiting effects associated with the finite time duration of the sampling aperture.

Settling Time: The interval between the internal track-hold transition and the time at which the held output signal is settled to within a specified accuracy. It does not include the pipeline delay of the clock buffer but does include the group delay of the output amplifier.

Spurious Free Dynamic Range (SFDR): The ratio (usually expressed in dB) between the sinusoidal output signal amplitude and the amplitude of the largest non-linearity product falling within one Nyquist bandwidth. It may be specified for both full scale input and some fraction(s) of full scale input. A SFDR based only on 2nd order nonlinear products is referred to as the 2nd order SFDR (SFDR2). A SFDR based only on 3rd order products is referred to as the 3rd order SFDR (SFDR3).

Total Harmonic Distortion (THD): The ratio of the total power in the non-linearity-generated harmonics and harmonic aliases (measured in one Nyquist band) to the output signal power.

**WIDEBAND 4 GS/S TRACK-AND-HOLD AMPLIFIER
DC - 5 GHz****Application Notes**

General: The HMC760LC4B wideband single rank T/H amplifier is optimized for use in microwave data conversion applications requiring maximum sampling bandwidth, high linearity over a very wide bandwidth, and low noise. A key application of this device is front end sampling for high speed A/D converters to enhance their input bandwidth and/or high frequency linearity. Although several high speed A/D converters offer enhanced sample rates, few of them offer input bandwidth beyond a few GHz. In addition, maintenance of good sampling linearity at frequencies beyond the UHF band is technologically challenging and most A/D converters suffer rapidly degraded linearity above 1 or 2 GHz signal frequency. The HMC760LC4B can address these limitations with its 5 GHz input bandwidth and excellent broadband linearity. Once sampling takes place within the T/H, the low bandwidth held output waveform can be processed by an A/D with substantially reduced bandwidth. In addition, A/D converter linearity performance limitations at high input frequencies are also mitigated because the settled waveform is processed with the optimal baseband linearity of the A/D converter.

The single rank T/H has one T/H amplifier and produces an output which consists of two segments. In the track mode interval of the output waveform (positive differential clock voltage) the device behaves as a unity gain amplifier which replicates the input signal at the output subject to the input bandwidth and the output amplifier bandwidth limitations. At the positive to negative clock transition the device samples the input signal with a very narrow sampling time aperture and holds the output relatively constant during the negative clock interval at a value which is representative of the signal at the instant of sampling. The single rank device (as opposed to a dual rank T/H) is often preferable for front end sampling with A/D converters because most high-speed A/Ds already have a T/H, usually with much less bandwidth, integrated at the front end of the converter. Hence, the HMC760LC4B forms a composite dual rank assembly (or triple rank if there is a dual rank device in the converter) with the T/H in the converter. For equal technologies and designs, a single rank device will usually have better linearity and noise than a dual rank device, since the single rank has fewer stages. Hence, the single rank device is often the optimum choice for front end sampling with high speed A/Ds.

ESD: On-chip ESD protection networks are incorporated on the terminals, but the RF/microwave compatible interfaces provide minimal protection and ESD precautions should be used.

Power Supply Sequencing: The recommended power supply startup sequence is VccOB, VccOF, VccTH, VccCLK, Vee / VeeCLK if biased from independent supplies. VccOB, VccOF, VccTH and VccCLK can be connected to one +2V supply if desired.

Input Signal Drive: For best results, the inputs should be driven differentially. The input can be driven single-ended but the linearity of the device will be degraded somewhat. The unused input should be terminated in 50 Ohms when driving the device single-ended.

Clock Input: The device is in track-mode when (CLKP – CLKN) is high and it is in hold-mode when (CLKP – CLKN) is low. The clock inputs should be driven differentially if possible. The clock inputs can be driven single-ended if desired but the single-ended amplitude/slew rate should be similar to the full differential amplitude / slew rate recommended for differential drive. The unused input should be terminated in 50 Ohms.

The T/H-mode linearity of the device varies somewhat with clock power at lower clock frequencies as shown in the performance data plots. This results from a weak dependence of the linearity on clock zero crossing slew rate for slew rates beneath a critical value. For optimal linearity, a clock zero-crossing slew rate of roughly 2 - 4 V/ns (per clock input) or more is recommended. For sinusoidal clock inputs, 4 V/ns corresponds to a sinusoidal clock power per differential half-circuit input of -6 dBm at 4 GHz, 0 dBm at 2 GHz, and 6 dBm at 1 GHz. Regardless of the clock frequency, a minimum clock amplitude of -6 dBm is recommended (per differential half-circuit input)..

Outputs: The outputs should be sensed differentially for the cleanest output waveforms. The output impedance is 50 Ohms resistive returned to the VccOB supply. The output stage is designed to drive 50 Ohms terminated to ground on each differential half-circuit output. The device offers a true ground-referenced common mode output that is usually within ± 50 mV of ground; however it is possible to adjust the VccOB power supply slightly to fine tune the output common-mode level to precisely 0 V if desired. Additionally, the common-mode output level may be adjusted within the range of approximately ± 0.5 V by adjusting the VccOB power supply according to the approximate relation $V_{ocm} = (V_{ccOB} - 2)/2$ where V_{ocm} is the output common mode voltage and VccOB can be varied in the range of $+1V < V_{ccOB} < +3V$.

The bandwidth of the output amplifier that buffers the T/H signal between the hold-node and the 50 Ohm outputs

**WIDEBAND 4 GS/S TRACK-AND-HOLD AMPLIFIER
DC - 5 GHz****Application Notes** (Continued)

is approximately 7 GHz. Hence, the output amplitude of the sampled waveform may be somewhat larger than the track-mode response at high input frequencies due to the effect of the output amplifier bandwidth. In particular, frequencies beyond the output amplifier bandwidth will be attenuated by the transfer function of the output buffer while the held signal (which looks like DC to the settled output amplifier) will suffer little attenuation.

The broad output buffer bandwidth is maintained to support the fast settling times required for users operating at high clock rates. However, because of the broad bandwidth, the output amplifier noise contribution to the total output noise is significant. Users operating at lower clock rates (such as < 1 GHz) may optimize their signal-to-noise ratio by filtering the output to a lower bandwidth than the output amplifier bandwidth of 7 GHz. Such an output filter will not reduce the sampled front-end noise (which is frozen into the signal samples and represents the majority of the T/H noise because of the wide front-end bandwidth) but it can reduce the output amplifier noise contribution. The user can filter the output to the lowest bandwidth that still retains the maximum settling time required to support the chosen clock rate. Typically this optimal bandwidth is of the order of 2 to 3 times the clock rate and it can be realized with a simple single pole RC filter if desired. For example, a user operating at a clock rate of 350 MHz with a 1 GHz noise bandwidth output filter can achieve approximately 2 dB lower noise relative to the unfiltered output condition.

The output will have very sharp transitions at the clock edges due to the broad output amplifier bandwidth. The user should be aware that any significant length of cable between the chip output and the load will cause frequency response roll-off and dispersion that can produce low amplitude tails with relatively long time-constants in the settling of the output waveform into the load. This effect is most noticeable when operating in a lab setting with output cables of a few feet length, even with high quality cable. Output cables between the T/H and the load should be of very high quality and 2 ft or less in length.

Reflections between the load and the device will also degrade the hold mode response. The output cable length can be adjusted to minimize the reflection perturbations to some extent. In general, the round trip transit time of the cable should be an integer number of clock periods to obtain the minimal reflection perturbation in the hold mode portion of the waveform. The optimal performance is obtained when the T/H is within 50 ps or less of the load since this gives a reflection duration equal to the approximate settling time of the device. In A/D converter applications the T/H should be placed as close as possible to the A/D converter to minimize reflection effects on the path between the T/H output and the input of the A/D converter.

Linearity Measurement

When characterizing the linearity of a T/H, the transfer function linearity of the held samples (referred to as T/H-mode linearity) is usually the quantity of most interest to the user. These samples contain the signal information that is ultimately digitized by the downstream A/D converter. Since the T/H-mode linearity is often different than the track-mode linearity, this presents a unique measurement issue for the signal rank T/H in that the linearity of only the hold-portion of the analog output waveform must be selectively measured.

This issue is aggravated for high speed T/Hs because there are few wide-band time domain instruments (oscilloscopes or A/D converters) with sufficient linearity to characterize a high linearity T/H operating at high clock rates. Therefore a frequency domain instrument (spectrum analyzer) and measurement technique are used which allow selective characterization of the hold-mode portion of the waveform

A common approach to this requirement has been to cascade two T/Hs in a dual rank configuration such that the second T/H (T/H 2) re-samples the output of the first T/H (T/H 1). The two T/Hs are usually clocked 180 degrees out-of-phase in master-slave operation to eliminate the track-mode portion of the output waveform from the first T/H. This arrangement produces an output waveform that consists of two time segments. The first segment is the T/H 1 hold-mode output as observed through the T/H 2 track-mode transfer function. The second time segment is the T/H 1 hold-mode output re-sampled and held by the T/H 2 device. This measurement approach is not a perfect representation of the linearity of a single T/H due to the impact of the second T/H on the overall linearity. However, it does eliminate



Linearity Measurement (Continued)

the track-mode portion of the T/H 1 output and permits a spectrum analyzer linearity measurement of the cascaded devices. Since T/H 2 only has to sample the held waveform from T/H 1, the linearity impact of T/H 2 is primarily associated with its DC linearity. An often used approximation is that the DC linearity of T/H 2 is much higher than the slew-rate dependent, high frequency linearity of T/H 1 so that the total non-linearity of the cascade is dominated by the high frequency linearity of T/H 1. In this case, the dual rank configuration has a net linearity that closely resembles the linearity of a single T/H, particularly at high frequencies. However, this approximation is not always valid. If not, the dual rank configuration fails to represent the linearity of a single T/H. The HMC760LC4B represents such a case; the 3rd order nonlinearity of this device varies relatively slowly with frequency and is high enough over the T/H bandwidth that the DC linearity of the 2nd T/H significantly impacts the overall dual rank configuration for signal frequencies < 5 GHz.

In order to address the weakness of the dual rank technique for the single rank T/H linearity characterization, Hittite has developed a modified approach referred to as the attenuated dual rank technique. This method involves using a dual rank T/H configuration with significant attenuation A(dB) inserted between the 1st T/H and the 2nd T/H. A typical attenuation value is A = 10 dB although more can be used for improved linearity measurement accuracy at the expense of measurement dynamic range. This configuration still outputs a dual rank waveform that eliminates the track mode component but the attenuation of the signal into the 2nd device substantially reduces the contribution of its nonlinear products to the total spectrum such that the linearity of the 1st device dominates the overall linearity. This results from the fact that the device follows the normal nonlinear order dependence: the 2nd order product level relative to the fundamental is lowered by 10 dB for every 10 dB decrease in input level while the 3rd order product level relative to the fundamental is lowered by 20 dB for every 10 dB decrease in input level. The phase of the T/H 2 nonlinear products relative to the T/H 1 products can vary depending on the product frequency and the path length between the two devices. A worst case analysis of the uncertainty generated by the presence of the lower level T/H 2 products assuming identical devices for the two T/Hs and worst case phasing can be performed. Under these conditions, the worst case error bounds in the determination of T/H 1 spurious-free dynamic range (SFDR,) due to the presence of lower level T/H 2 non linear products is given by:

$$\Delta\text{SFDR}_2(\text{dB}) = 20 \log(1 \pm 10^{-A/20}) = +2.4, -3.3 \text{ dB for } A = 10 \text{ dB}$$

$$\Delta\text{SFDR}_3(\text{dB}) = 20 \log(1 \pm 10^{-A/10}) = +0.83, -0.92 \text{ dB for } A = 10 \text{ dB}$$

Where ΔSFDR_2 and ΔSFDR_3 are the errors in the 2nd order and 3rd order limited spurious-free dynamic ranges for T/H 1 respectively.

Over the range of DC - 5 GHz the 3rd order products tend to dominate the spurious-free dynamic range so the typical accuracy in assessing T/H 1 SFDR is of the order of ± 0.9 dB for this measurement method. At higher frequencies, the total linearity is dominated by the high frequency nonlinearity of T/H 1 and the contribution of T/H 2 DC nonlinearity is much lower than that indicated by ΔSFDR_2 above (which simplistically assumes equal linearity across the bandwidth). So the T/H 1 linearity determination error over the entire frequency range is of the order ± 0.9 dB for the attenuated dual rank measurement method with A = 10 dB.

Another linearity measurement issue unique to the T/H device is the need for output waveform frequency response correction. In the case of a dual rank T/H, the output waveform resembles a square wave with duration equal to the clock period. Mathematically, the output can be viewed as the convolution of an ideal delta-function sample train with a single square pulse of duration equal to one clock period. This weights the output spectral content with a $\text{SIN}(\pi f / f_s) / (\pi f / f_s)$ (Sinc function) frequency response envelope which has nulls at harmonics of the clock frequency f_s and substantial response reduction beyond half the clock frequency. This spectral content and envelope function are observed during spectrum analyzer measurement because the analyzer simply reproduces the entire spectrum of the incoming waveform. However, the spectral content of the held samples without the envelope weighting is required for proper measurement of the sample's linearity, as would be measured by a downstream A/D converter that samples a time instant in the held waveform. Either the impact of the response envelope must be corrected in the data or a measurement method must be used that heterodynes the relevant nonlinear harmonic products to low frequencies to avoid significant envelope response weighting. This latter method is referred to as the low frequency beat-product technique.

The low frequency beat-product technique is commonly used for high-speed T/H linearity measurements, although the measurement does impose restrictions on the specific input signal and clock frequencies that can be used. For example, with a clock frequency of 512.5 MHz, a single tone input at 995 MHz beats with the 2nd harmonic of the

**WIDEBAND 4 GS/S TRACK-AND-HOLD AMPLIFIER
DC - 5 GHz**

Linearity Measurement (Continued)

sampling frequency (through the sampling process) to produce a 1st order beat product at 30 MHz. Likewise, the 2nd and 3rd harmonics of the input signal (generated via distortion in the T/H) beat with the 4th and 6th harmonics of the sampling frequency respectively to produce 2nd and 3rd order beat products at 60 MHz and 90 MHz. In this manner, the T/H nonlinearity in the vicinity of 1 GHz can be measured even though the 995 MHz fundamental and the 1.99 GHz and 2.985 GHz nonlinear harmonics are well beyond the 256 MHz 4 dB bandwidth of the SINx/x response envelope.

The possible input frequency choices are overly limited when the low frequency beat-product technique is used at high clock rates. A related high frequency beat-product measurement utilizing correction for the SINx/x envelope weighting must be employed to measure linearity over a wide range of input frequencies. Hittite uses both low frequency and high frequency beat product methods to measure linearity for a wide range of clock and signal frequencies. Our high frequency beat-product measurement avoids excessive envelope correction error by maintaining all beat products within the 4 dB bandwidth of the SINx/x function, where the envelope response is well behaved and easily modeled.

Absolute Maximum Ratings

VccTH, VccOF, VccCLK	2.1 Vdc
VccOB	3 Vdc
Vee, VeeCLK	-5.25 Vdc
CLKP, CLKN Input Power	+10 dBm
INP, INN Input Power	+10 dBm
Junction Temperature	125 °C
Continuous P _{diss} (T= 85 °C)	2 W
Thermal Resistance (junction to package bottom)	20 °C/W
Storage Temperature	-65 to +150 °C
Operating Temperature	-40 to +85 °C
ESD Sensitivity (HBM)	Class 1B

**ELECTROSTATIC SENSITIVE DEVICE
OBSERVE HANDLING PRECAUTIONS**



Outline Drawing

PRODUCT TYPE - SMT

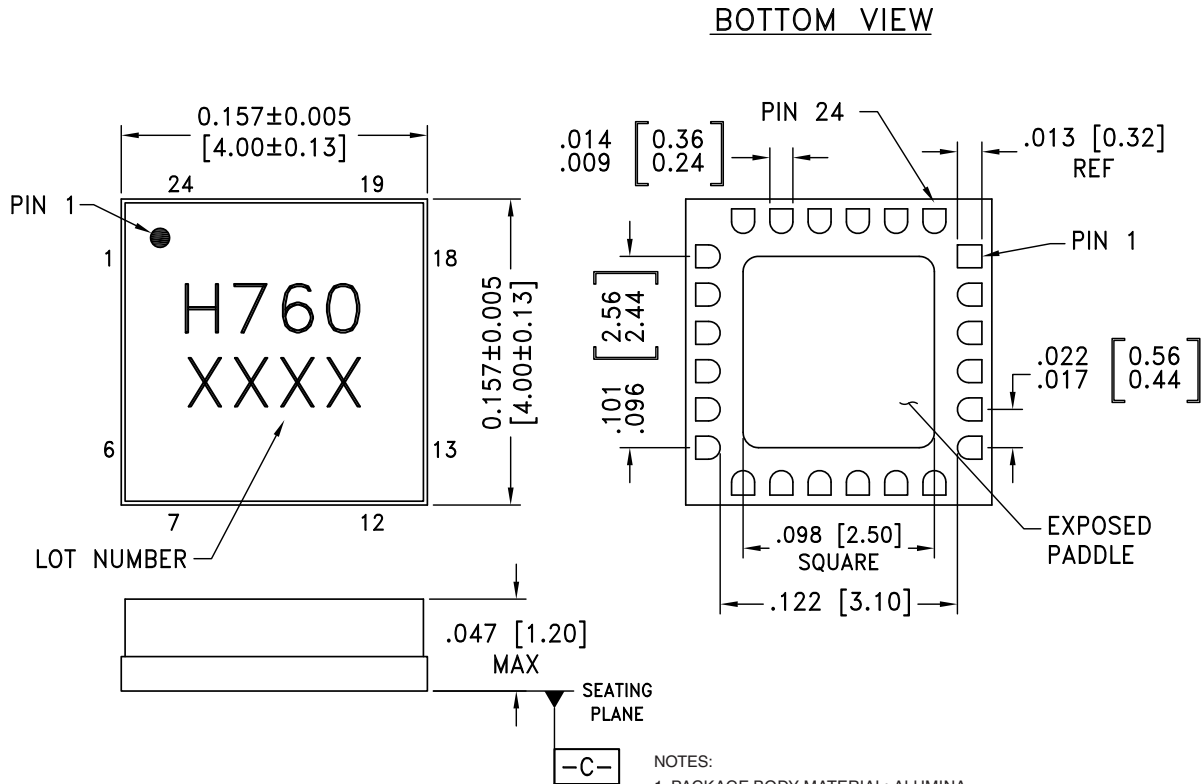

Package Information

Part Number	Package Body Material	Lead Finish	MSL Rating	Package Marking ^[2]
HMC760LC4B	Alumina, White	Gold over Nickel	MSL3 ^[1]	H760 XXXX



[1] Max peak reflow temperature of 260 °C

[2] 4-Digit lot number XXXX

WIDEBAND 4 GS/S TRACK-AND-HOLD AMPLIFIER DC - 5 GHz

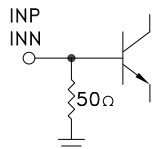
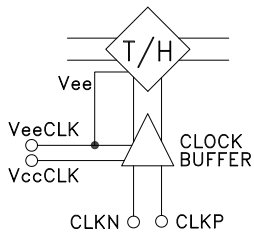

Pin Descriptions

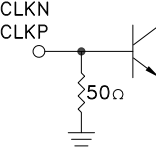
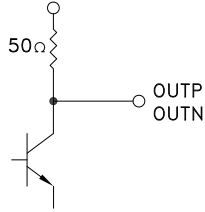
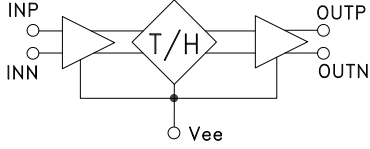
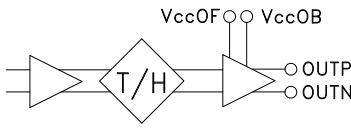
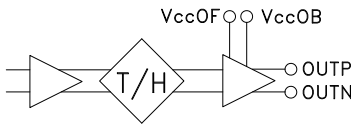
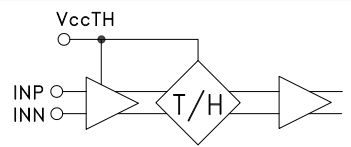
Pin Number	Function	Description	Interface Schematic
1, 2, 5, 13, 14, 17, 18	GNDa	Analog ground. This ground and clock ground must be connected to the same DC potential but they can be RF-isolated from each other if desired.	
3	INP	Positive T/H input. Has on-chip DC 50 Ω termination, nominal max single-ended input level = ±0.25 V (-2 dBm) for specified performance, +10 dBm max.	
4	INN	Negative T/H input. Has on-chip DC 50 Ω termination, nominal max single-ended input level = ±0.25 V (-2 dBm) for specified performance, +10 dBm max.	
6	VeeCLK	Negative clock buffer supply. VeeCLK and Vee must be connected to the same potential. Total (Vee+VeeCLK) nominal current is -216 mA at -4.75 V.	
7	VccCLK	Clock buffer power. Requires 25 mA nominal current at 2 V.	
8, 11, 12	GNDc	Clock ground. This ground and analog ground must be connected to the same DC potential but they can be RF-isolated from each other.	
9,10	CLKN, CLKP	Negative CLK input, Positive CLK input. Has on-chip 50 Ω termination, +10 dBm max.	
15, 16	OUTP, OUTN	Positive T/H RF output, Negative T/H RF output. 50 Ω output impedance, nominal DC common mode output voltage = 0 V. 50 Ω load impedance can be DC or AC coupled.	
19, 21, 24, Package Base	Vee	Negative analog supply. Total (Vee+VeeCLK) current is -216 mA @ -4.75 V	
20	VccOB	50 Ω output buffer power. VccOB current is 72 mA @ 2 V. The output common mode voltage can be adjusted by the user by varying VccOB in the range of +1 V to +3 V such that Vocm ~ 1/2(VccOB-2) for DC coupled output.	
22	VccOF	Output buffer supply. Requires a nominal current of 39 mA at 2 V.	
23	VccTH	T/H core supply. Requires nominal current of 62 mA at 2 V.	

**WIDEBAND 4 GS/S TRACK-AND-HOLD AMPLIFIER
DC - 5 GHz**



Evaluation PCB

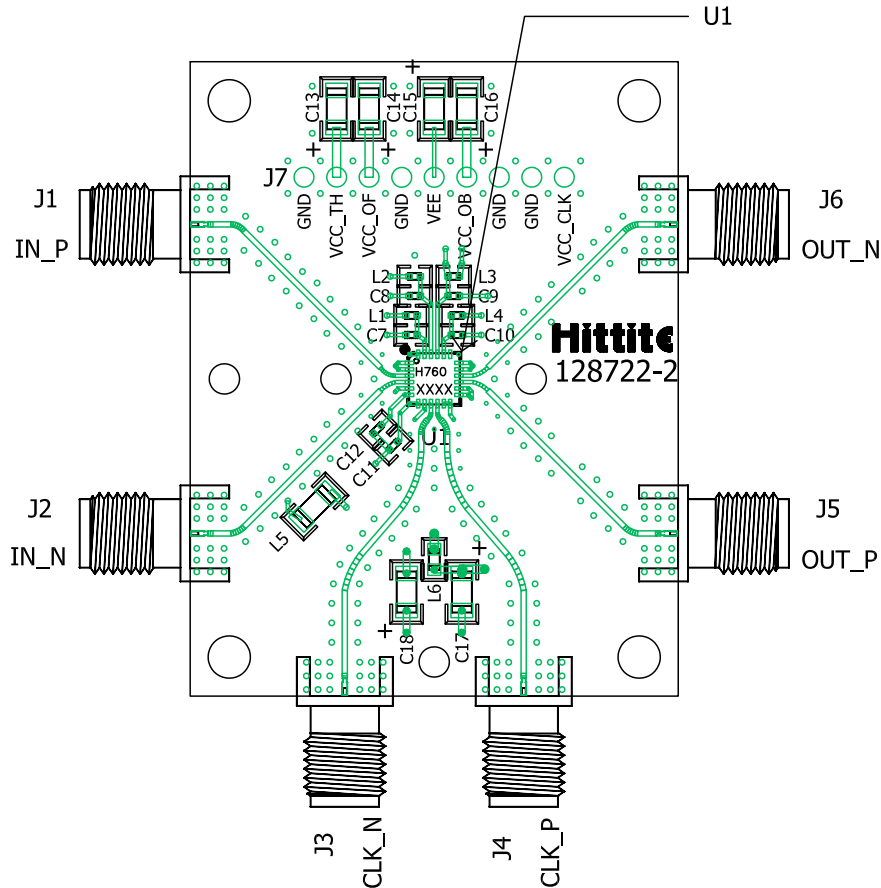

**List of Materials for Evaluation PCB
EVAL01-HMC760LC4B [1]**

Item	Description
J1, J2, J5, J6	SRI K-Connector
J3, J4	SRI SMA-Connector
J7	HEADER, 0.9", 9 pin, THRUHOLE, TIN
C7 - C12	0.01 μ F Capacitor, 0402 Pkg.
C13 - C18	4.7 μ F Capacitor, Tantalum
L1 - L4	Ferrite, 0402, Steward LI0402E300R-10
L5	Ferrite, 1206, Steward HF1206J150R-10
L6	Ferrite, 0603, Steward LI0603E470R-10
U1	HMC760LC4B Track-and-Hold Amplifier
PCB [2]	128722 Evaluation Board

The circuit board used in the application should use RF circuit design techniques. Signal lines should have 50 ohm impedance while the package ground leads should be connected directly to the ground plane similar to that shown. The package base is internally connected to the Vee and VeeCLK supply and should be connected to a Vee supply plane for heat sinking. A sufficient number of via holes should be used to connect the top and bottom ground planes in order to provide good RF grounding. The evaluation circuit board shown is available from Hittite upon request.

[1] Reference this number when ordering complete evaluation PCB

[2] Circuit Board Material: Arlon 25FR or Rogers 4350