



SUCCESSIVE DETECTION LOG VIDEO AMPLIFIER (SDLVA) WITH LIMITED RF OUTPUT, 1 - 20 GHz

Typical Applications

The HMC813LC4B is ideal for:

- EW, ELINT & IFM Receivers
- DF Radar Systems
- ECM Systems
- Broadband Test & Measurement
- Power Measurement & Control Circuits
- Military & Space Applications

Features

- High Logging Range: 55 dB
- Frequency Flatness: ± 1.5 dB
- Saturated Output Power: -7 dBm
- Fast Rise/Fall Times: 5/10 ns
- Single Positive Supply: +3.3V
- ESD Sensitivity (HBM): Class 1A
- 24 Lead 4x4 mm SMT Package: 16 mm²

Functional Diagram

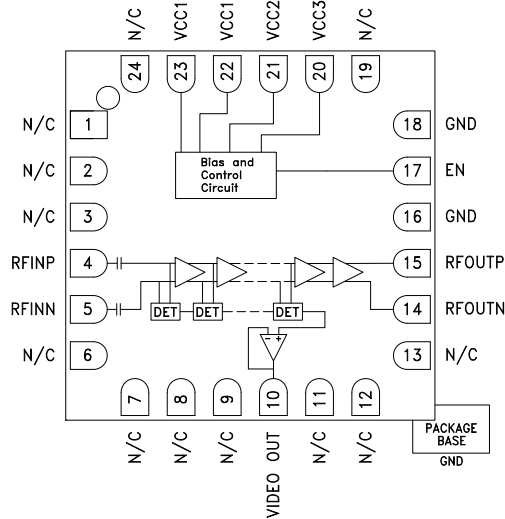

General Description

The HMC813LC4B is a Successive Detection Log Video Amplifier (SDLVA) with a limited RF output which operates from 1 to 20 GHz. The HMC813LC4B provides a logging range of 55 dB. This device offers typical fast rise/fall times of 5/10 ns. The HMC813LC4B log video output slope is typically 15 mV/dB. Maximum recovery times are less than 15 ns. Ideal for high speed channelized receiver applications, the HMC813LC4B operates from a single +3.3 V supply, and consumes only 153 mA. The HMC813LC4B is available in a highly compact 4x4 mm SMT ceramic package and is ideal for high speed channelized receiver applications.

Electrical Specifications, $T_A = +25^\circ\text{C}$, $V_{cc1} = V_{cc2} = V_{cc3} = 3.3\text{V}$ [1]

Parameter	Conditions	Typ.	Units
Input Frequency Range ^[2]		1 - 20	GHz
Frequency Flatness (Video out)	Pin= -25 dBm	± 1.5	dB
Log Linearity	Pin= -40 dBm to +0 dBm	± 1	dB
Log Linearity over Temperature	-55 to +85° C, Pin= -20 dBm	± 0.5	dB
Minimum Logging Range	to ± 3 dB error @ 18 GHz	-53	dBm
Maximum Logging Range	to ± 3 dB error @ 18 GHz	7	dBm
Saturated Output Power, Psat		-7	dBm
Saturated Output Power Flatness		± 1.5	dB
RF Input Return Loss		8	dB
RF Output Return Loss		18	dB
Log Video Minimum Output Voltage		0.9	V
Log Video Maximum Output Voltage		1.73	V
Log Video Output Rise Time	Pin = 0 dBm, 10% to 90%	5	ns
Log Video Output Fall Time	Pin = 0 dBm, 90% to 10%	10	ns

[1] Electrical specifications and performance plots are given for single-ended operation.

[2] Video output load should be 1K Ohm or higher.



**SUCCESSIVE DETECTION LOG VIDEO AMPLIFIER (SDLVA)
WITH LIMITED RF OUTPUT, 1 - 20 GHz**

Electrical Specifications, (continued) [1]

Parameter	Conditions	Typ.	Units
Log Video Recovery Time	-40 dBm to 0 dBm	15	ns
Log Video Output Slope		15	mV/dB
Log Video Output Slope Variation over Temperature	@ 10 GHz	10	$\mu\text{V}/\text{dB}^\circ\text{C}$
Log Video Propagation Delay		15	ns
Supply Current (I _{dc})		153	mA

[1] Electrical specifications and performance plots are given for single-ended operation

Error Flatness vs. Input Power Over Frequency [1]

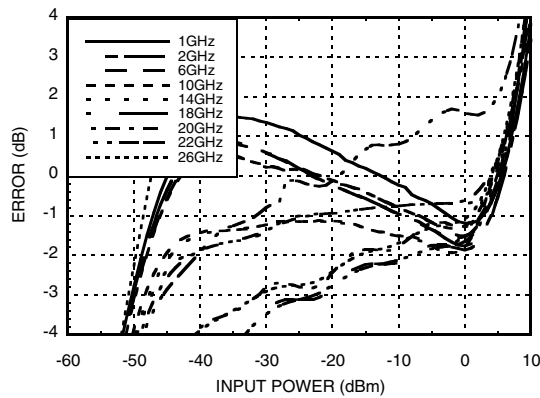

VIDEO OUT & Error vs. Input Power, Fin = 1 GHz [1]

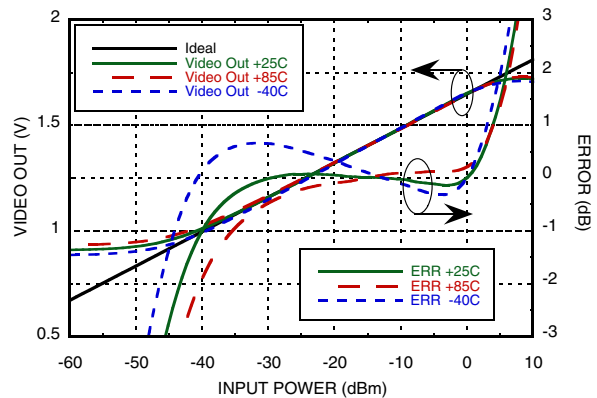

VIDEO OUT & Error vs. Input Power, Fin = 2 GHz [1]

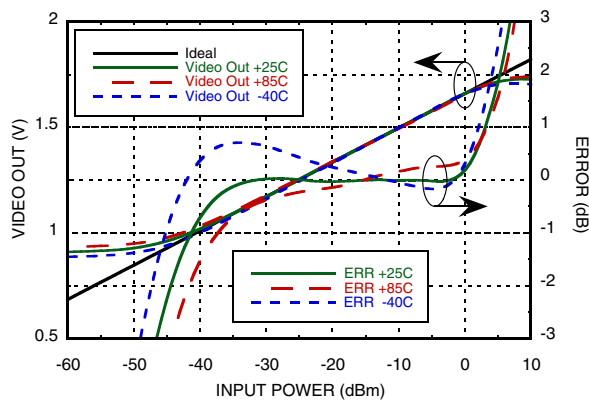

VIDEO OUT & Error vs. Input Power, Fin = 6 GHz [1]

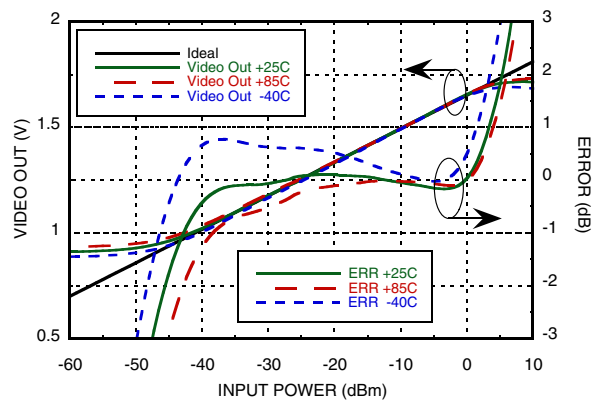

[1] Electrical specs and performance plots are given for single-ended operation

Information furnished by Analog Devices is believed to be accurate and reliable. However, no responsibility is assumed by Analog Devices for its use, nor for any infringements of patents or other rights of third parties that may result from its use. Specifications subject to change without notice. No license is granted by implication or otherwise under any patent or patent rights of Analog Devices. Trademarks and registered trademarks are the property of their respective owners.

For price, delivery, and to place orders: Analog Devices, Inc., One Technology Way, P.O. Box 9106, Norwood, MA 02062-9106 Phone: 781-329-4700 • Order online at www.analog.com Application Support: Phone: 1-800-ANALOG-D



**SUCCESSIVE DETECTION LOG VIDEO AMPLIFIER (SDLVA)
WITH LIMITED RF OUTPUT, 1 - 20 GHz**

VIDEO OUT & Error vs. Input Power, $F_{in} = 10$ GHz ^[1]

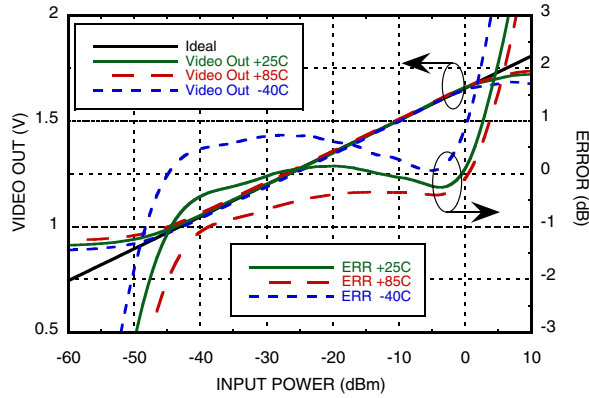

VIDEO OUT & Error vs. Input Power, $F_{in} = 14$ GHz ^[1]

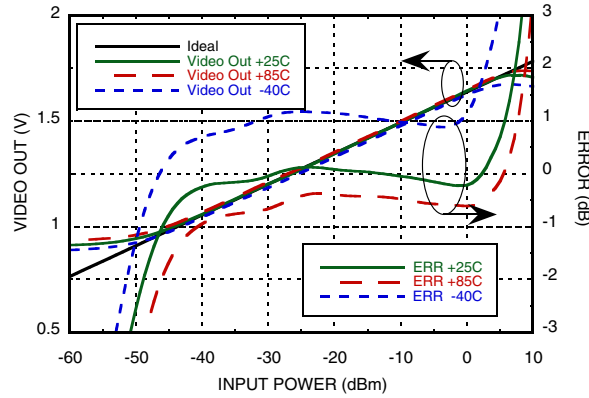

VIDEO OUT vs. Error vs. Input Power, $F_{in} = 18$ GHz ^[1]

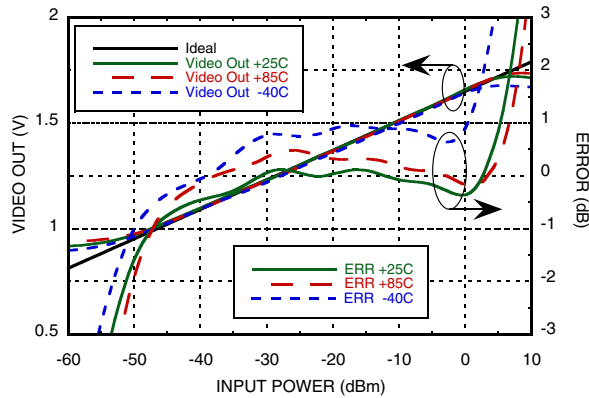

VIDEO OUT & Error vs. Input Power, $F_{in} = 20$ GHz ^[1]

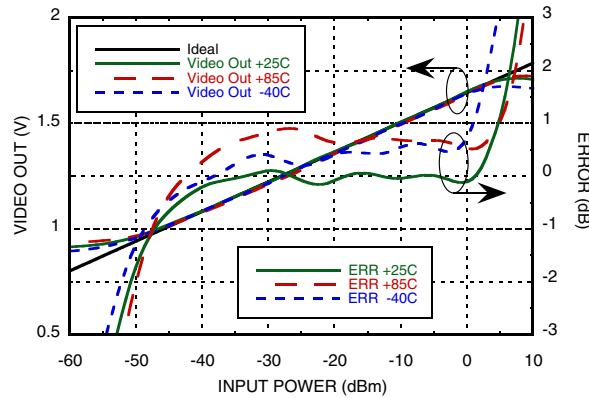

VIDEO OUT & Error vs. Input Power, $F_{in} = 22$ GHz ^[1]

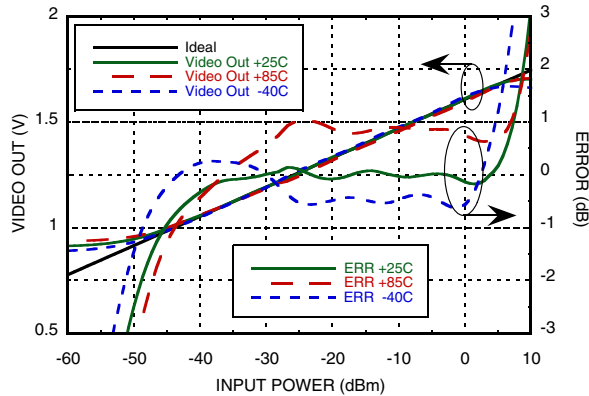

VIDEO OUT & Error vs. Input Power, $F_{in} = 26$ GHz ^[1]

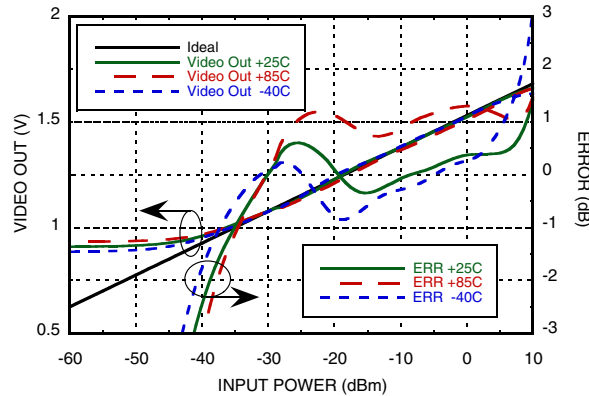

[1] Electrical specs and performance plots are given for single-ended operation



**SUCCESSIVE DETECTION LOG VIDEO AMPLIFIER (SDLVA)
WITH LIMITED RF OUTPUT, 1 - 20 GHz**

**VIDEO OUT vs. Frequency
Over Input Power & Temperature [1]**

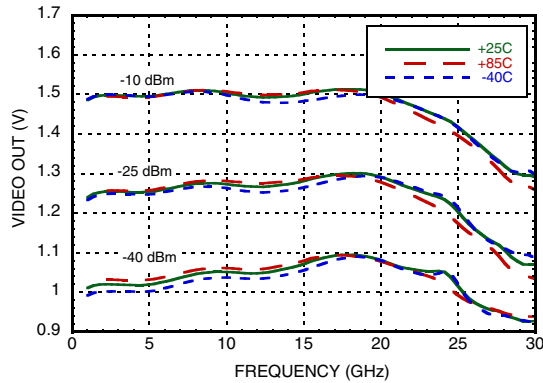

**Saturated RF Output Power vs. Frequency
Over Temperature @ Pin = -10 dBm [1]**

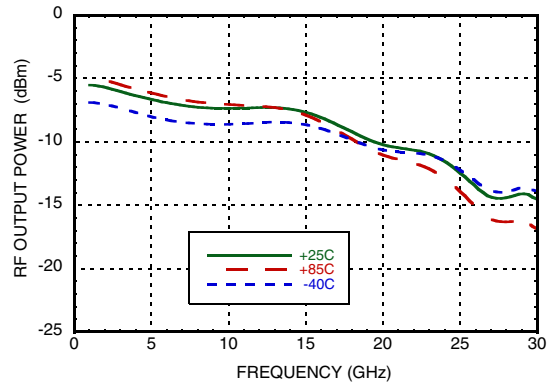

**RF Output Power vs. Input Power
Over Frequency [1]**

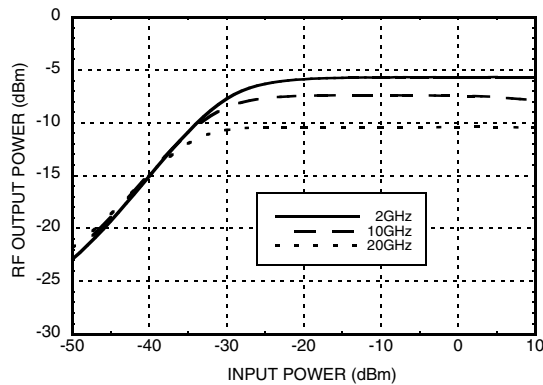

**Phase Linearity over Frequency @ 25 C
Temperature [1]**

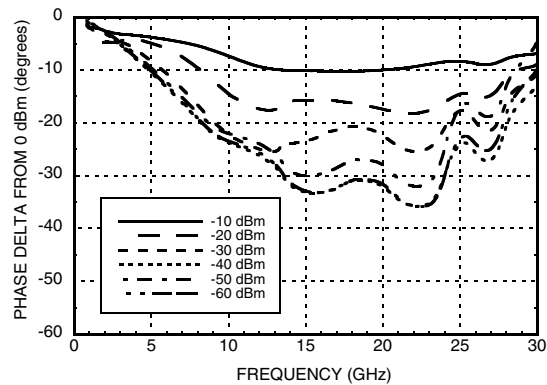

**Phase Linearity over Frequency @ 85 C
Temperature [1]**

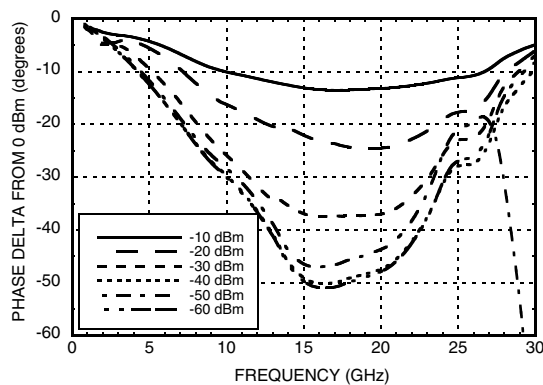

**Phase Linearity over Frequency @ -40 C
Temperature [1]**

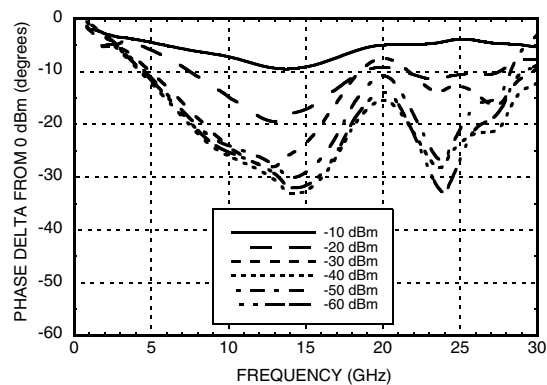

[1] Electrical specs and performance plots are given for single-ended operation

v03.0614



**SUCCESSIVE DETECTION LOG VIDEO AMPLIFIER (SDLVA)
WITH LIMITED RF OUTPUT, 1 - 20 GHz**

**Rise Time for Various Frequencies
@ Pin = 0 dBm [1]**

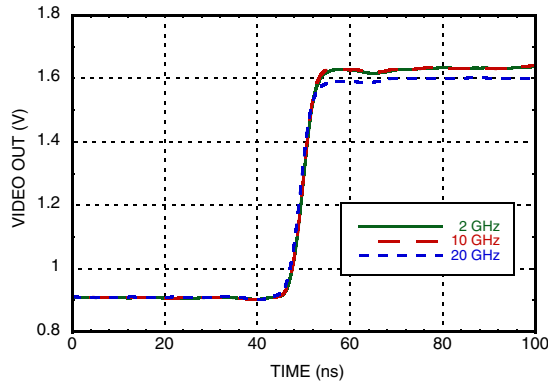

**Fall Time for Various Frequencies
@ Pin = 0 dBm [1]**

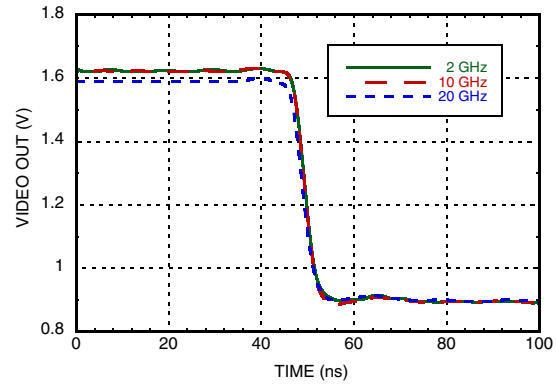

**Return Loss vs. Frequency
Over Temperature [1]**

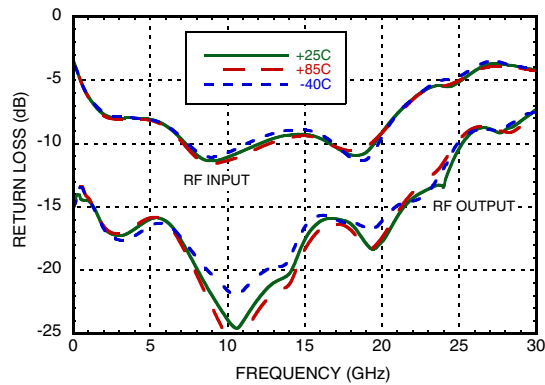

[1] Electrical specs and performance plots are given for single-ended operation

Information furnished by Analog Devices is believed to be accurate and reliable. However, no responsibility is assumed by Analog Devices for its use, nor for any infringements of patents or other rights of third parties that may result from its use. Specifications subject to change without notice. No license is granted by implication or otherwise under any patent or patent rights of Analog Devices. Trademarks and registered trademarks are the property of their respective owners.

For price, delivery, and to place orders: Analog Devices, Inc., One Technology Way, P.O. Box 9106, Norwood, MA 02062-9106
Phone: 781-329-4700 • Order online at www.analog.com
Application Support: Phone: 1-800-ANALOG-D



SUCCESSIVE DETECTION LOG VIDEO AMPLIFIER (SDLVA) WITH LIMITED RF OUTPUT, 1 - 20 GHz

Absolute Maximum Ratings

Vcc1, Vcc2, Vcc3, Vcc4	+3.6V
ENBL	+3.6V
RF Input Power	+15 dBm
Channel Temperature	125 °C
Continuous P _{diss} (T=85°C) Derate 12.63 mW/°C above 85°C	0.51 W
Thermal Resistance (Channel to die bottom)	79.20 °C/W
Storage Temperature	-65 to +150 °C
Operating Temperature	-55 to +85 °C
ESD Sensitivity (HBM)	Class 1A



ELECTROSTATIC SENSITIVE DEVICE
OBSERVE HANDLING PRECAUTIONS

Outline Drawing

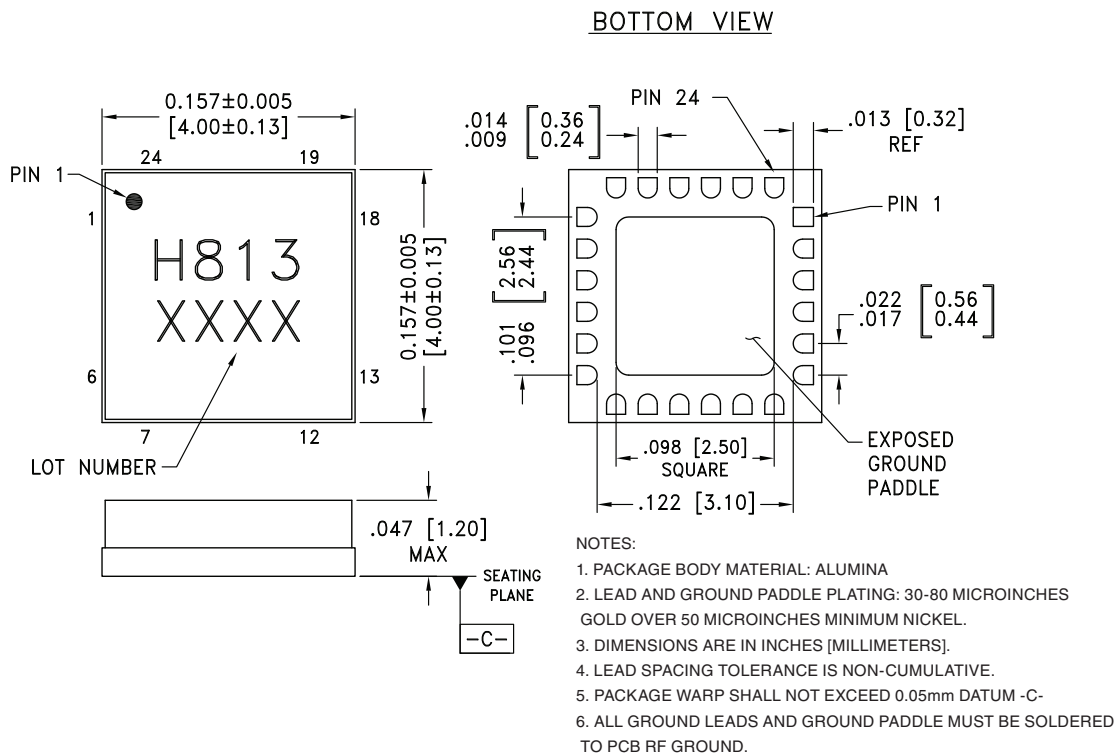

Package Information

Part Number	Package Body Material	Lead Finish	MSL Rating	Package Marking ^[2]
HMC813LC4B	Alumina, White	Gold over Nickel	MSL3 ^[1]	H813 XXXX



[1] Max peak reflow temperature of 260 °C

[2] 4-Digit lot number XXXX

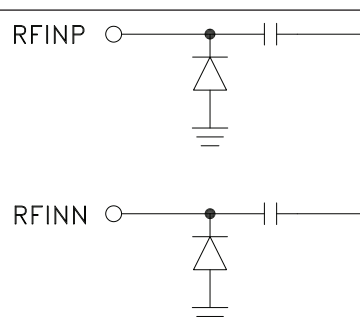
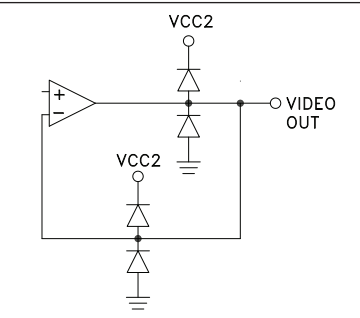
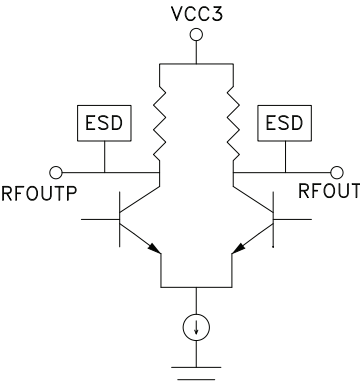

SUCCESSIVE DETECTION LOG VIDEO AMPLIFIER (SDLVA) WITH LIMITED RF OUTPUT, 1 - 20 GHz

Pin Descriptions

Pin Number	Function	Description	Interface Schematic
1-3, 6-9, 11-13, 19, 24	N/C	The pins are not connected internally; however, all data shown herein was measured with these pins connected to RF/DC ground externally.	
4, 5	RFINP, RFINN	RF Input pins. Connect RF to RFINP, and AC couple RFINN to ground via 50 Ohm for single ended operation.	
10	VIDEO OUT	Video out load should be at least 1K Ohm or higher.	
14, 15	RFOUTN, RFOUTP	RF Output pins. Connect RF to RFOUTP, and AC couple RFOUTN to ground via 50 Ohm for single ended operation	
16, 18	GND	These pins and the exposed package bottom must be connected to a high quality RF/DC ground.	



SUCCESSIVE DETECTION LOG VIDEO AMPLIFIER (SDLVA) WITH LIMITED RF OUTPUT, 1 - 20 GHz

Pad Descriptions (Continued)

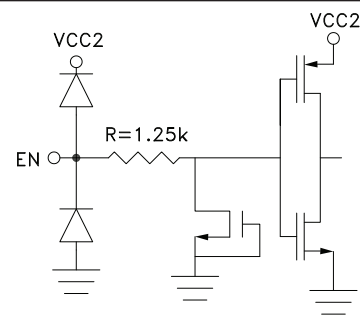
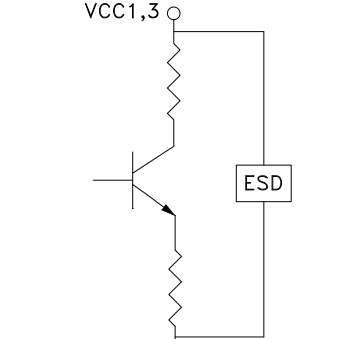
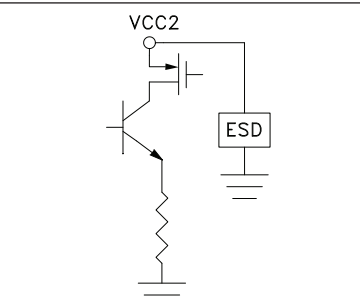
Pin Number	Function	Description	Interface Schematic
17	EN	Enable pin, connected to supply voltage for normal operation. Total supply current reduced to less than 3mA when EN is set to 0V.	
20	VCC3	Bias supply. Connect supply voltage to these pins with appropriate filtering. See application circuit. To ensure proper start-up supply rise time should be faster than 100usec	
22, 23	VCC1		
21	VCC2	Bias supply. Connect supply voltage to this pin with appropriate filtering. See application circuit. To ensure proper start-up supply rise time should be faster than 100usec	



**SUCCESSIVE DETECTION LOG VIDEO AMPLIFIER (SDLVA)
WITH LIMITED RF OUTPUT, 1 - 20 GHz**

Application Circuit

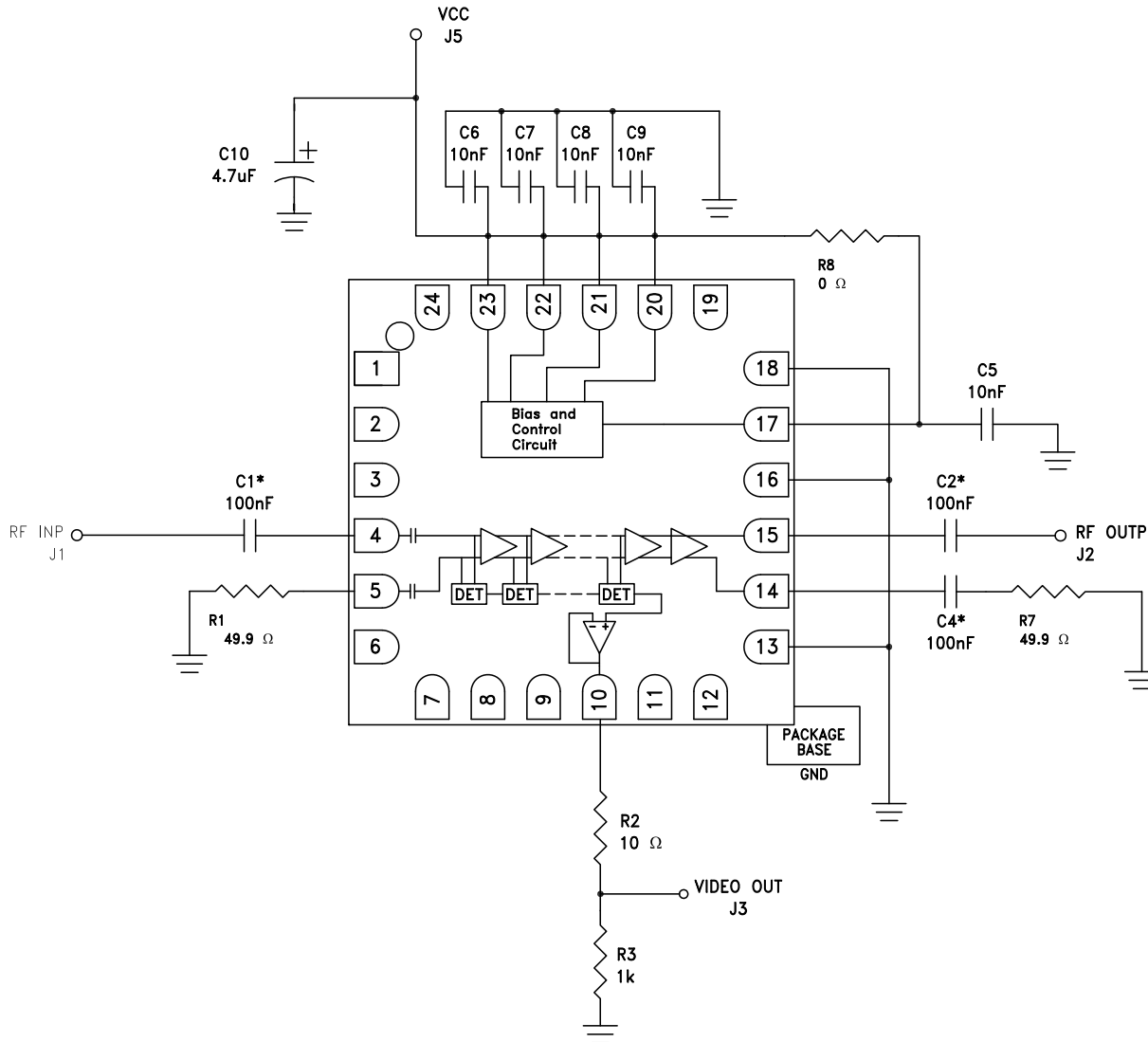

*C1, C2 and C4 are ultra-wideband capacitors.

Note: Video output load should be 1K Ohm or higher.