

FEATURES

Passive, wideband, I/Q mixer
RF and LO frequency range: 6 GHz to 26.5 GHz
Wide IF frequency range: dc to 5 GHz
Single-ended RF, LO, and IF
Conversion loss: 9.5 dB (typical)
Image rejection: 29.5 dBc (typical)
Single sideband noise figure: 12 dB (typical)
Input IP3: 22 dBm (typical)
Input P1dB: 15 dBm (typical) as a downconverter
Input IP2: 54 dBm (typical)
LO to RF isolation: 43.5 dB (typical)
LO to IF isolation: 42 dB (typical)
RF to IF isolation: 22 dB (typical)
Amplitude balance: 0.3 dB (typical)
Phase balance: 0.8° (typical)
RF return loss: 12 dB (typical)
LO return loss: 22.5 dB (typical)
IF return loss: 15.5 dB (typical)

APPLICATIONS

Test and measurement instrumentation
Military, aerospace, and defense
Microwave point to point base stations

GENERAL DESCRIPTION

The HMC8191CHIPS is a passive, wideband, inphase and quadrature (I/Q), monolithic microwave integrated circuit (MMIC) mixer that can be used either as an image rejection mixer for receiver operations or as a single sideband upconverter for transmitter operations. With an RF and local oscillator (LO) range of 6 GHz to 26.5 GHz, and an intermediate frequency (IF) bandwidth of dc to 5 GHz, the HMC8191CHIPS is ideal for applications requiring a wide frequency range, excellent RF performance, a simple design with fewer components, and a small printed circuit board (PCB) footprint. A single HMC8191CHIPS can replace multiple narrow-band mixers in a design.

The inherent I/Q architecture of the HMC8191CHIPS offers excellent image rejection of 29.5 dBc typical, eliminating the

need for expensive filtering for unwanted sidebands. The mixer provides excellent LO to RF isolation of 43.5 dB typical, and LO to IF isolation of 42 dB typical. The mixer also reduces the effect of LO leakage to ensure signal integrity.

As a passive mixer, the HMC8191CHIPS does not require any dc power sources. The device offers a lower noise figure compared to an active mixer, ensuring optimal dynamic range for high performance and precision applications.

The HMC8191CHIPS is fabricated on a gallium arsenide (GaAs), metal semiconductor field effect transistor (MESFET) process and uses Analog Devices, Inc., mixer cells and a 90° hybrid.

FUNCTIONAL BLOCK DIAGRAM

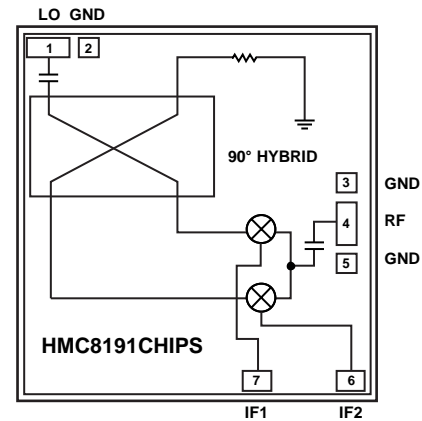

Figure 1.

23122-001

TABLE OF CONTENTS

Features.....	1	Upconverter Performance: IF = 2500 MHz, Lower Sideband (High-Side LO).....	20
Applications	1	Upconverter Performance: IF = 5000 MHz, Lower Sideband (High-Side LO).....	22
Functional Block Diagram	1	Upconverter Performance: IF = 100 MHz, Upper Sideband (Low-Side LO)	24
General Description	1	Upconverter Performance: IF = 2500 MHz, Upper Sideband (Low-Side LO)	26
Revision History	2	Upconverter Performance: IF = 5000 MHz, Upper Sideband (Low-Side LO)	28
Specifications	3	Isolation and Return Loss	30
Absolute Maximum Ratings	4	IF Bandwidth Performance: Downconverter, Lower Sideband (High-Side LO)	32
Electrostatic Discharge (ESD) Ratings	4	IF Bandwidth Performance: Downconverter, Upper Sideband (Low-Side LO).....	33
ESD Caution.....	4	Amplitude and Phase Imbalance Performance: Downconverter, Lower Sideband (High-Side LO).....	34
Pin Configuration and Function Descriptions	5	Amplitude and Phase Imbalance Performance: Downconverter, Upper Sideband (Low-Side LO).....	36
Interface Schematics	5	Spurious and Harmonics Performance	38
Typical Performance Characteristics.....	6	Theory of Operation	39
Downconverter Performance: IF = 100 MHz, Lower Sideband (High-Side LO).....	6	Applications Information	40
Downconverter Performance: IF = 2500 MHz, Lower Sideband (High-Side LO).....	8	Outline Dimensions.....	41
Downconverter Performance: IF = 5000 MHz, Lower Sideband (High-Side LO).....	10	Ordering Guide	41
Downconverter Performance: IF = 100 MHz, Upper Sideband (Low-Side LO)	12		
Downconverter Performance: IF = 2500 MHz, Upper Sideband (Low-Side LO)	14		
Downconverter Performance: IF = 5000 MHz, Upper Sideband (Low-Side LO)	16		
Upconverter Performance: IF = 100 MHz, Lower Sideband (High-Side LO).....	18		

REVISION HISTORY

4/2020—Revision 0: Initial Version

SPECIFICATIONS

$T_A = 25^\circ\text{C}$, IF = 100 MHz, LO drive = 18 dBm, all measurements are performed as downconverter with lower sideband selected, an external 90° hybrid at the IFx ports, and an LO amplifier in line with the lab bench LO source, unless otherwise noted.

Table 1.

Parameter	Min	Typ	Max	Unit
FREQUENCY				
RF	6		26.5	GHz
LO	6		26.5	GHz
IF	DC		5	GHz
LO DRIVE LEVEL		18		dBm
RF PERFORMANCE AS DOWNCONVERTER				
Conversion Loss		9.5	11	dB
Image Rejection	18	29.5		dBc
Single Sideband Noise Figure		12		dB
Input Third-Order Intercept (IP3)	20	22		dBm
Input 1 dB Compression Point (P1dB)		15		dBm
Input Second-Order Intercept (IP2)		54		dBm
Balance				
Amplitude ¹		0.3		dB
Phase ¹		0.8		Degrees
ISOLATION				
RF to IF		22		dB
LO to RF	30	43.5		dB
LO to IF		42		dB
RF PERFORMANCE AS UPCONVERTER				
Conversion Loss		9.5		dB
Sideband Rejection		26.5		dBc
Input IP3		22		dBm
Input P1dB		12		dBm
RETURN LOSS PERFORMANCE¹				
RF		12		dB
LO		22.5		dB
IF		15.5		dB

¹ Measurements taken without a 90° hybrid at the IFx ports.

ABSOLUTE MAXIMUM RATINGS

Table 2.

Parameter	Rating
Input Power	
RF	24 dBm
LO	24 dBm
IF	24 dBm
IF Source and Sink Current	3 mA
Continuous Power Dissipation (P_{DISS}), $T_A = 85^\circ\text{C}$, Derate 7.29 mW/ $^\circ\text{C}$ Above 85°C	657 mW
Temperature	
Junction	175°C
Peak Reflow (Moisture Sensitivity Level 3 (MSL3))	260°C
Operating Range	-40°C to $+85^\circ\text{C}$
Storage Range	-65°C to $+150^\circ\text{C}$

Stresses at or above those listed under Absolute Maximum Ratings may cause permanent damage to the product. This is a stress rating only; functional operation of the product at these or any other conditions above those indicated in the operational section of this specification is not implied. Operation beyond the maximum operating conditions for extended periods may affect product reliability.

ELECTROSTATIC DISCHARGE (ESD) RATINGS

The following ESD information is provided for handling of ESD-sensitive devices in an ESD protected area only.

Human body model (HBM) per ANSI/ESDA/JEDEC JS-001.

Field induced charged device model (FICDM) per ANSI/ESDA/JEDEC JS-002.

ESD Ratings for HMC8191CHIPS

Table 3. HMC8191CHIPS, 7-Pad CHIP

ESD Model	Withstand Threshold (V)	Class
HBM	750	1B
FICDM	1200	C3

ESD CAUTION



ESD (electrostatic discharge) sensitive device. Charged devices and circuit boards can discharge without detection. Although this product features patented or proprietary protection circuitry, damage may occur on devices subjected to high energy ESD. Therefore, proper ESD precautions should be taken to avoid performance degradation or loss of functionality.

PIN CONFIGURATION AND FUNCTION DESCRIPTIONS

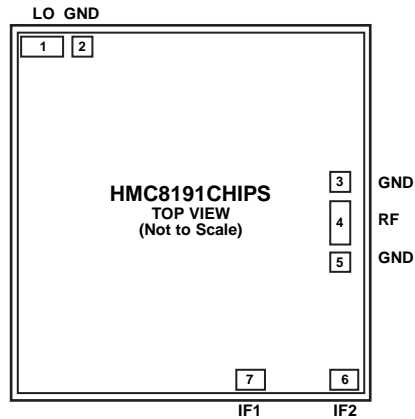

Figure 2. Pad Configuration

Table 4. Pad Function Descriptions

Pad No.	Mnemonic	Description
1	LO	LO Input. The LO pad is dc-coupled and matched to 50 Ω when the LO turns on. See Figure 6 for the interface schematic.
2, 3, and 5	GND	Ground. The GND pads must be connected to RF and dc ground. See Figure 3 for the interface schematic.
4	RF	RF Input and Output. The RF pad is dc-coupled and matched to 50 Ω when the LO turns on. See Figure 5 for the interface schematic.
6, 7	IF2, IF1	Second and First Quadrature IF Input and Output Pads. The IF2 and IF1 pads are dc-coupled. For applications that do not require operation to dc, use an off chip dc blocking capacitor. For applications that require operation to dc, the IF2 and IF1 pads must not source and sink more than 3 mA of current. Otherwise, the device may not function and may fail. See Figure 4 for the interface schematic.

INTERFACE SCHEMATICS



Figure 3. GND Interface Schematic

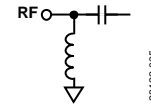

Figure 5. RF Interface Schematic

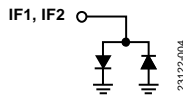

Figure 4. IF1 and IF2 Interface Schematic

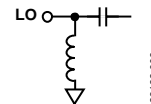

Figure 6. LO Interface Schematic

TYPICAL PERFORMANCE CHARACTERISTICS

DOWNCONVERTER PERFORMANCE: IF = 100 MHz, LOWER SIDEBAND (HIGH-SIDE LO)

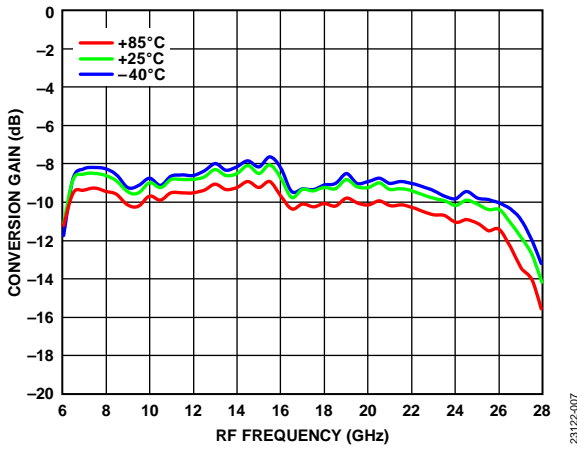

Figure 7. Conversion Gain vs. RF Frequency at Various Temperatures, LO Drive = 18 dBm

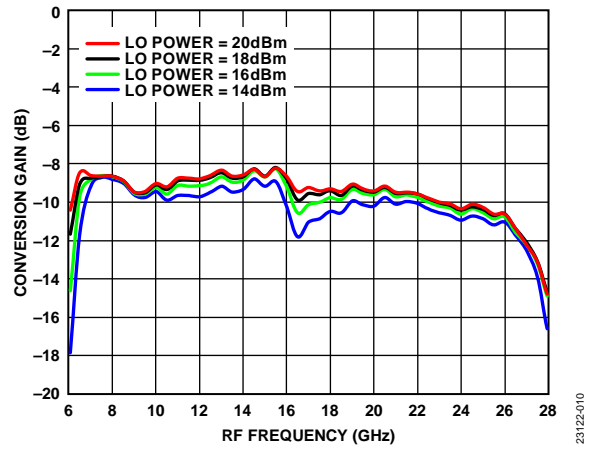

Figure 10. Conversion Gain vs. RF Frequency at Various LO Drives, $T_A = 25^\circ\text{C}$

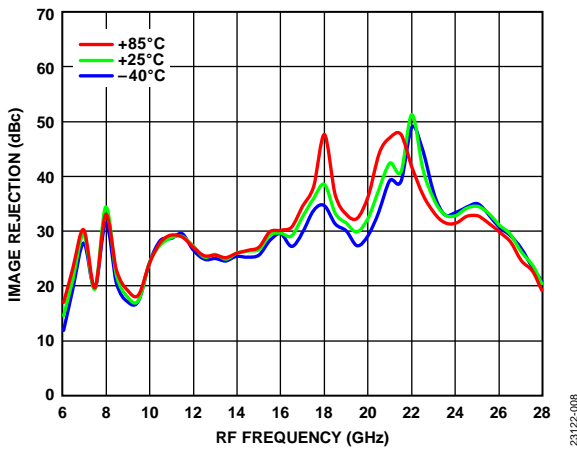

Figure 8. Image Rejection vs. RF Frequency at Various Temperatures, LO Drive = 18 dBm

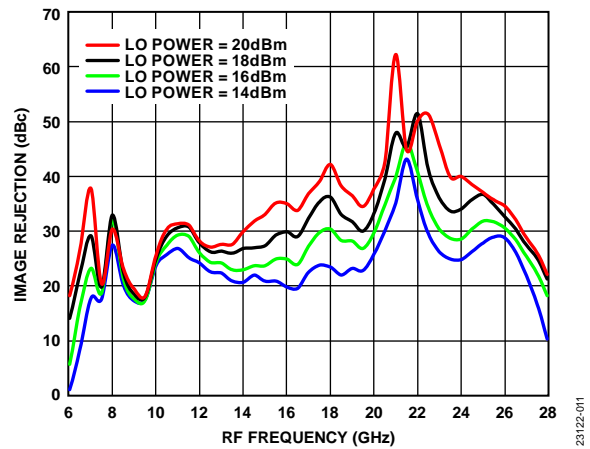

Figure 11. Image Rejection vs. RF Frequency at Various LO Drives, $T_A = 25^\circ\text{C}$

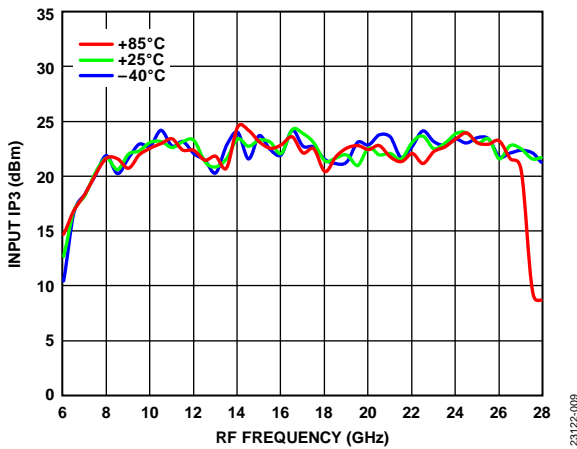

Figure 9. Input IP3 vs. RF Frequency at Various Temperatures, LO Drive = 18 dBm

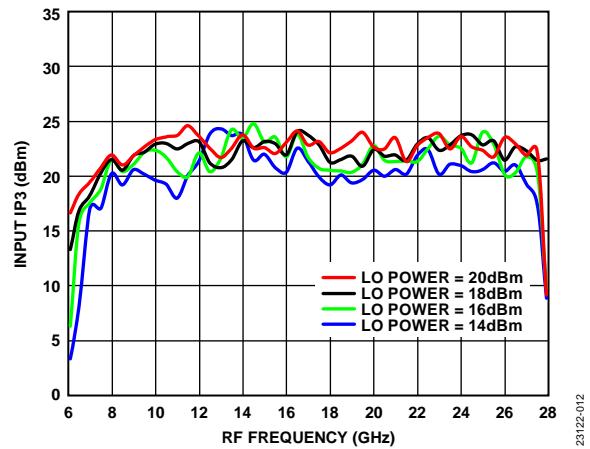

Figure 12. Input IP3 vs. RF Frequency at Various LO Drives, $T_A = 25^\circ\text{C}$

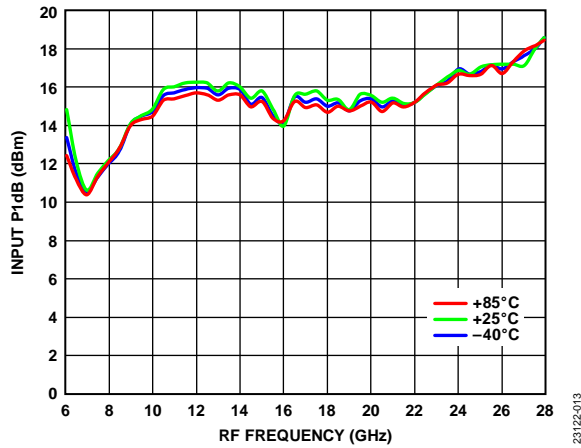

Figure 13. Input P1dB vs. RF Frequency at Various Temperatures, LO Drive = 18 dBm

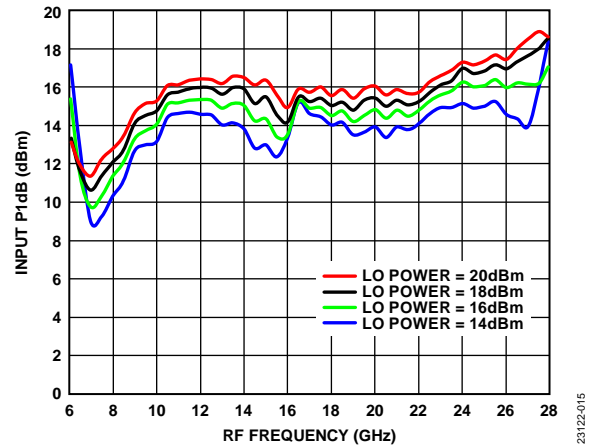

Figure 15. Input P1dB vs. RF Frequency at Various LO Drives, $T_A = 25^\circ\text{C}$

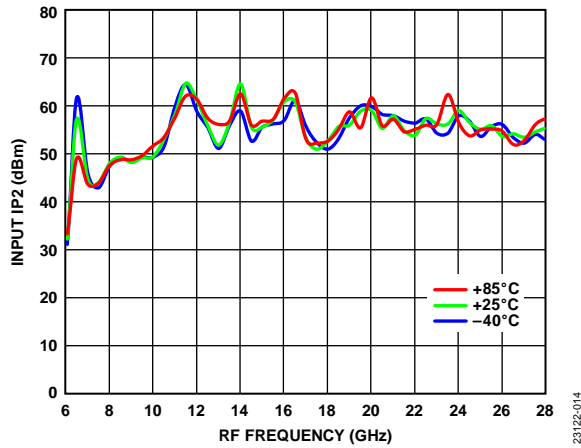

Figure 14. Input IP2 vs. RF Frequency at Various Temperatures, LO Drive = 18 dBm

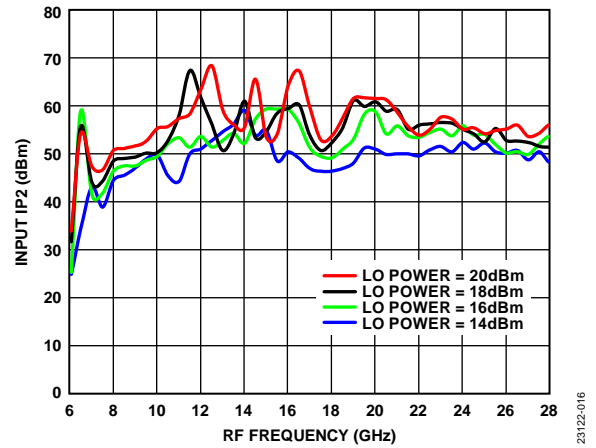

Figure 16. Input IP2 vs. RF Frequency at Various LO Drives, $T_A = 25^\circ\text{C}$

DOWNCONVERTER PERFORMANCE: IF = 2500 MHz, LOWER SIDEBAND (HIGH-SIDE LO)

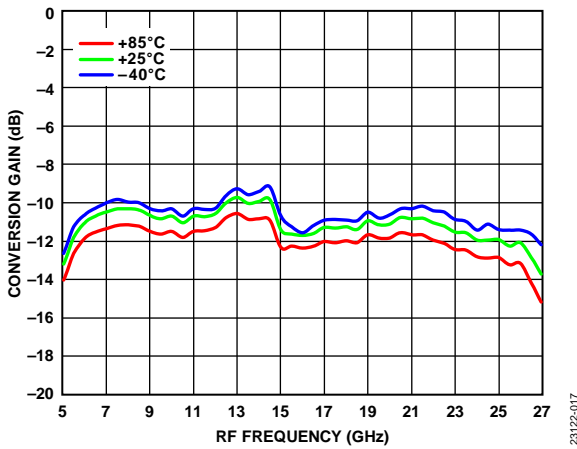

Figure 17. Conversion Gain vs. RF Frequency at Various Temperatures, LO Drive = 18 dBm

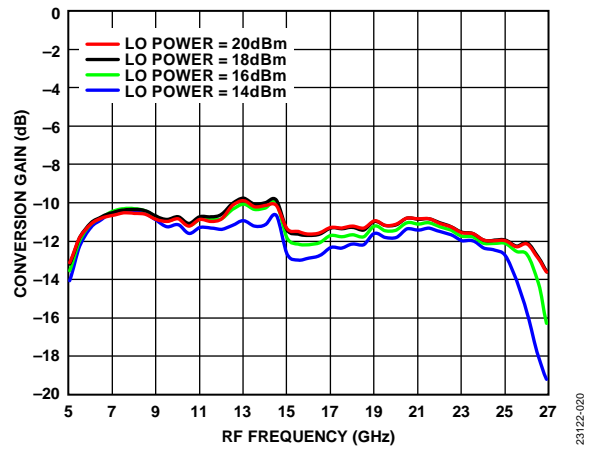

Figure 20. Conversion Gain vs. RF Frequency at Various LO Drives, $T_A = 25^\circ\text{C}$

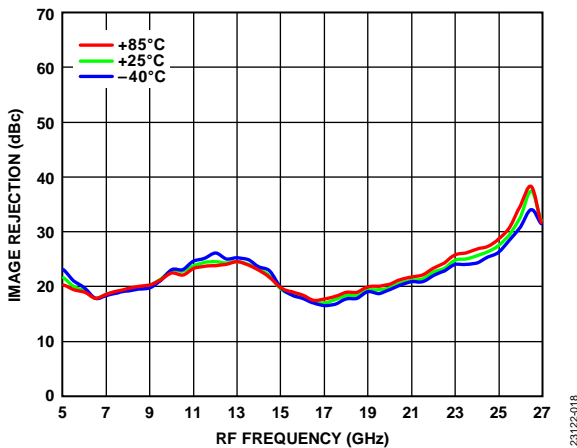

Figure 18. Image Rejection vs. RF Frequency at Various Temperatures, LO Drive = 18 dBm

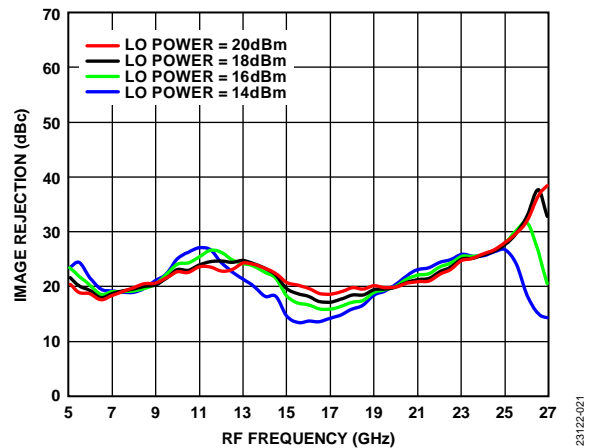

Figure 21. Image Rejection vs. RF Frequency at Various LO Drives, $T_A = 25^\circ\text{C}$

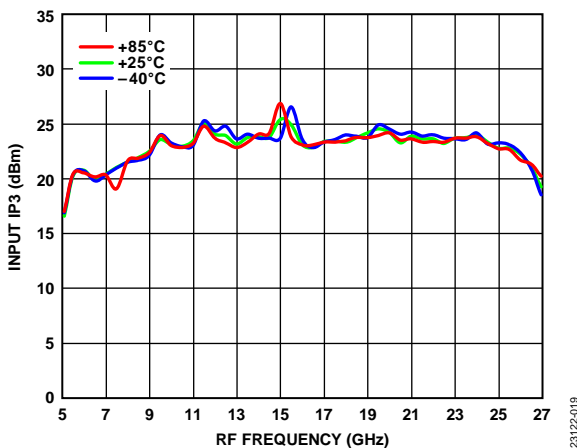

Figure 19. Input IP3 vs. RF Frequency at Various Temperatures, LO Drive = 18 dBm

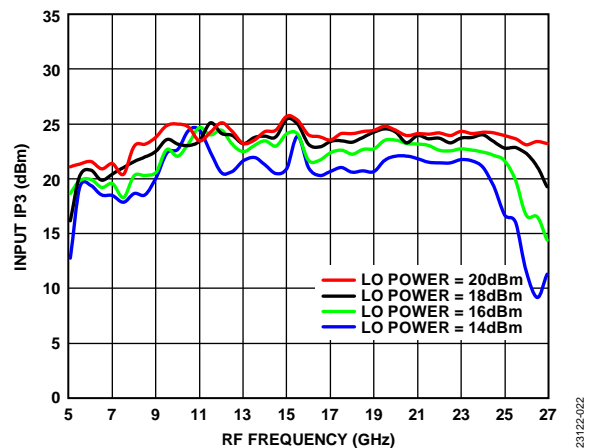

Figure 22. Input IP3 vs. RF Frequency at Various LO Drives, $T_A = 25^\circ\text{C}$

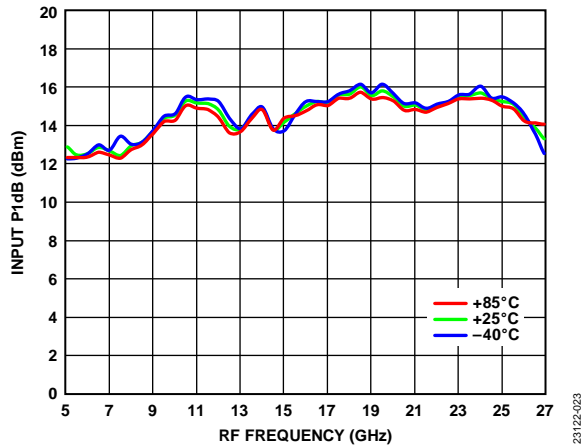

Figure 23. Input P1dB vs. RF Frequency at Various Temperatures, LO Drive = 18 dBm

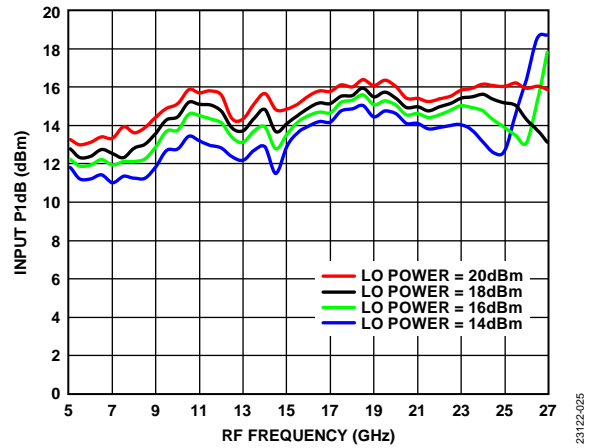

Figure 25. Input P1dB vs. RF Frequency at Various LO Drives, $T_A = 25^\circ\text{C}$

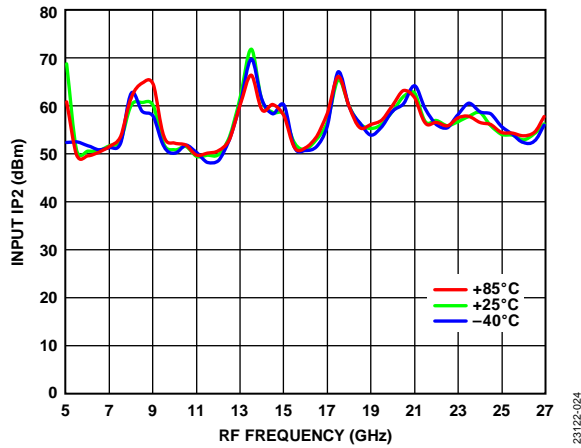

Figure 24. Input IP2 vs. RF Frequency at Various Temperatures, LO Drive = 18 dBm

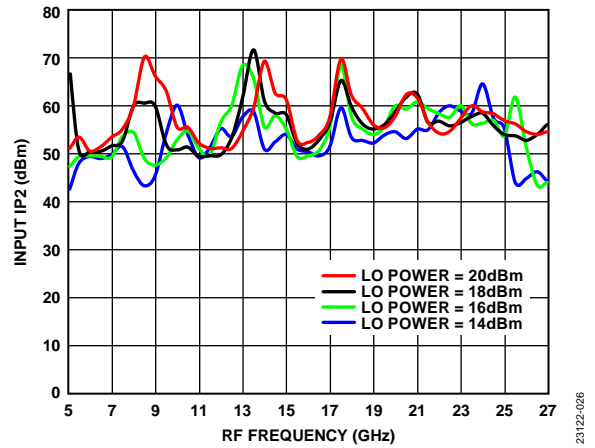

Figure 26. Input IP2 vs. RF Frequency at Various LO Drives, $T_A = 25^\circ\text{C}$

DOWNCONVERTER PERFORMANCE: IF = 5000 MHz, LOWER SIDEBAND (HIGH-SIDE LO)

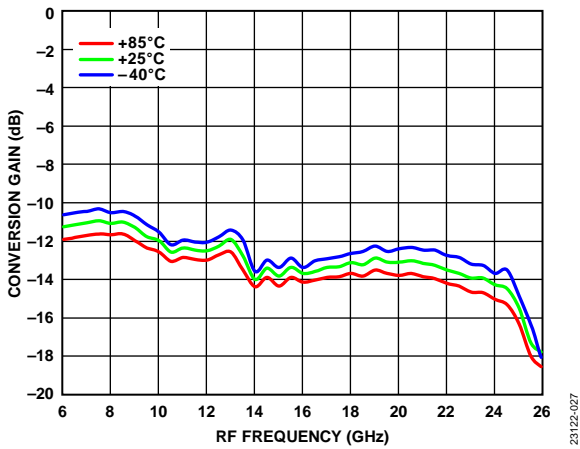

Figure 27. Conversion Gain vs. RF Frequency at Various Temperatures, LO Drive = 18 dBm

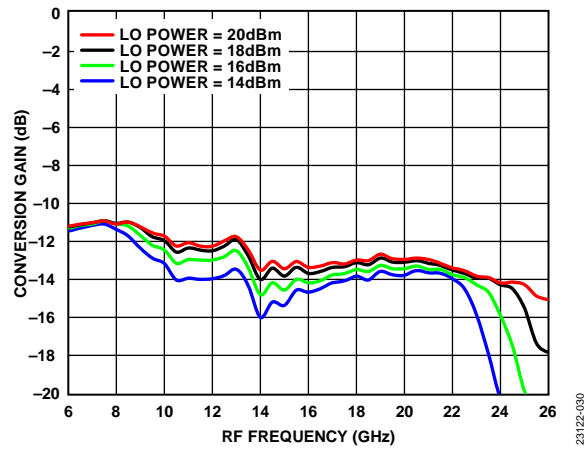

Figure 30. Conversion Gain vs. RF Frequency at Various LO Drives, $T_A = 25^\circ\text{C}$

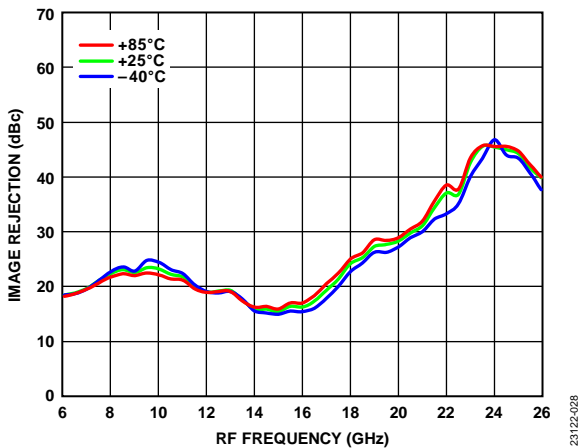

Figure 28. Image Rejection vs. RF Frequency at Various Temperatures, LO Drive = 18 dBm

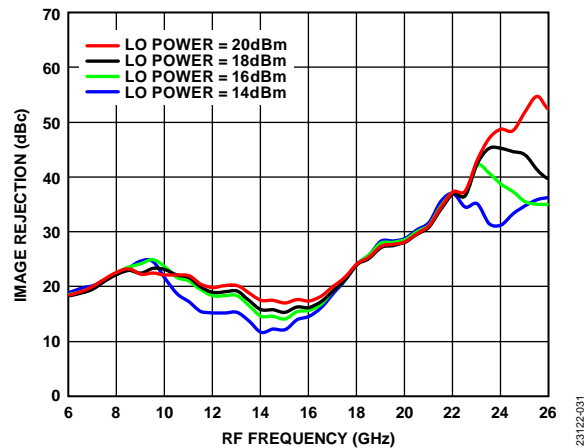

Figure 31. Image Rejection vs. RF Frequency at Various LO Drives, $T_A = 25^\circ\text{C}$

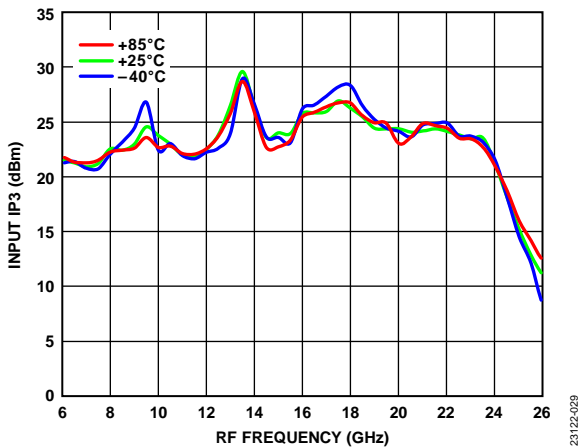

Figure 29. Input IP3 vs. RF Frequency at Various Temperatures, LO Drive = 18 dBm

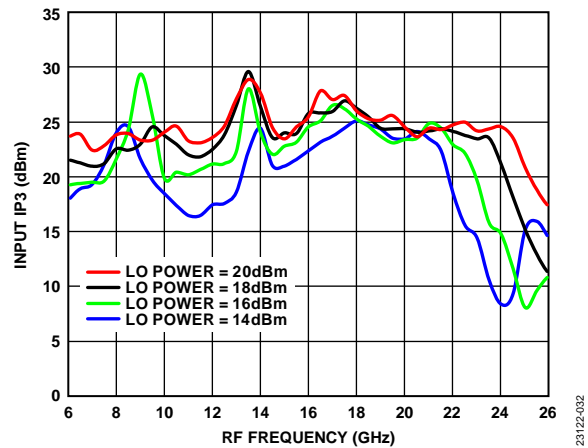

Figure 32. Input IP3 vs. RF Frequency at Various LO Drives, $T_A = 25^\circ\text{C}$

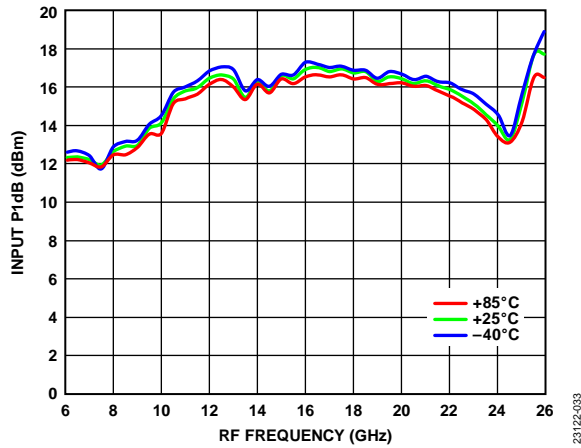

Figure 33. Input P1dB vs. RF Frequency at Various Temperatures, LO Drive = 18 dBm

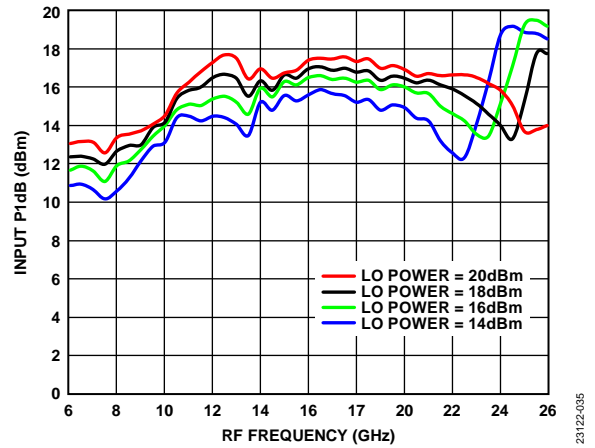

Figure 35. Input P1dB vs. RF Frequency at Various LO Drives, $T_A = 25^\circ\text{C}$

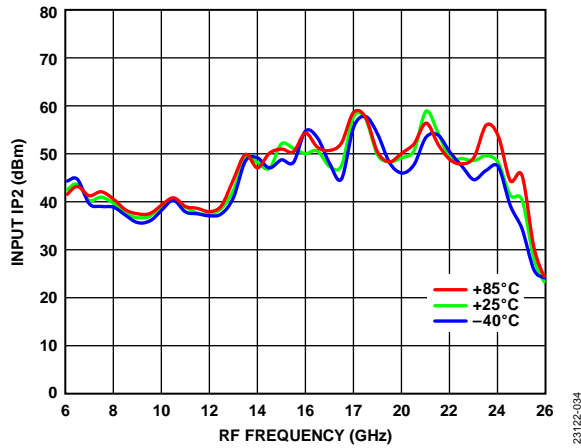

Figure 34. Input IP2 vs. RF Frequency at Various Temperatures, LO Drive = 18 dBm

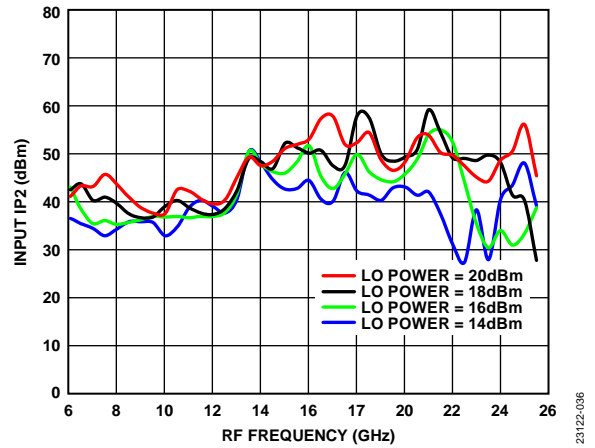

Figure 36. Input IP2 vs. RF Frequency at Various LO Drives, $T_A = 25^\circ\text{C}$

DOWNCONVERTER PERFORMANCE: IF = 100 MHz, UPPER SIDEBAND (LOW-SIDE LO)

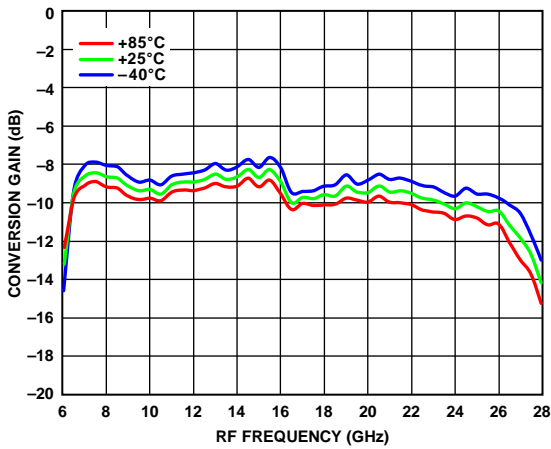

Figure 37. Conversion Gain vs. RF Frequency at Various Temperatures, LO Drive = 18 dBm

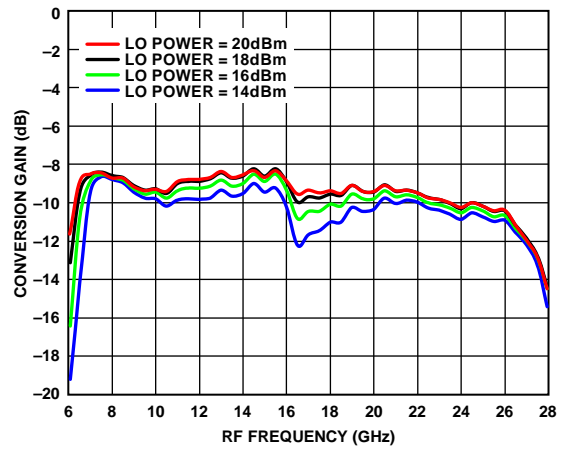

Figure 40. Conversion Gain vs. RF Frequency at Various LO Drives, $T_A = 25^\circ\text{C}$

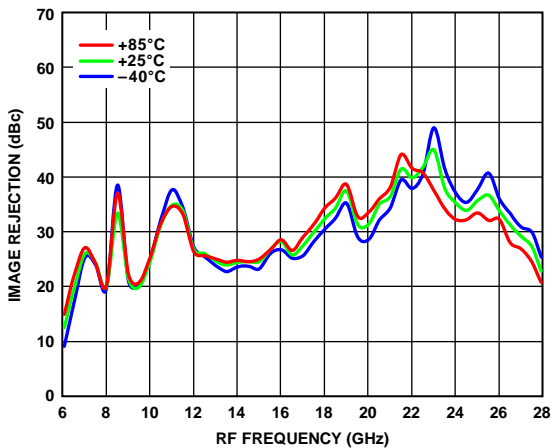

Figure 38. Image Rejection vs. RF Frequency at Various Temperatures, LO Drive = 18 dBm

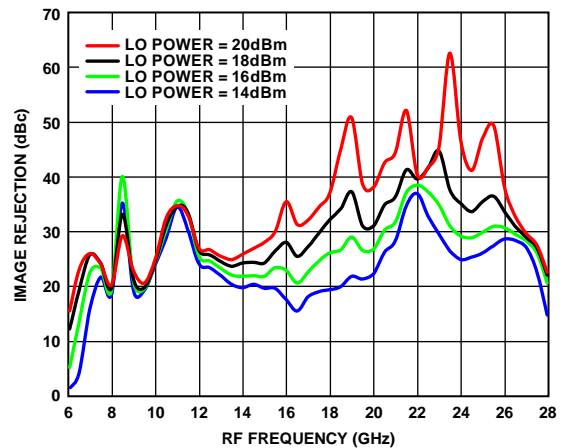

Figure 41. Image Rejection vs. RF Frequency at Various LO Drives, $T_A = 25^\circ\text{C}$

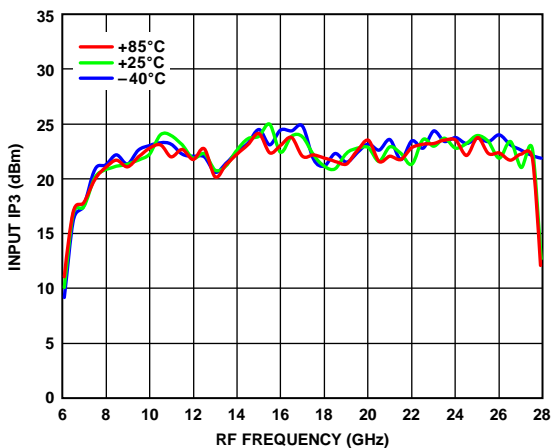

Figure 39. Input IP3 vs. RF Frequency at Various Temperatures, LO Drive = 18 dBm

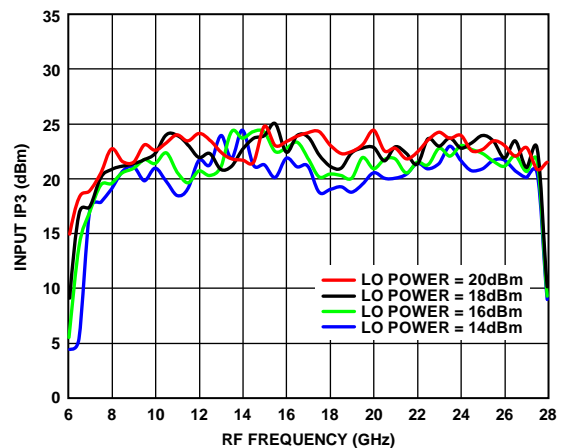

Figure 42. Input IP3 vs. RF Frequency at Various LO Drives, $T_A = 25^\circ\text{C}$

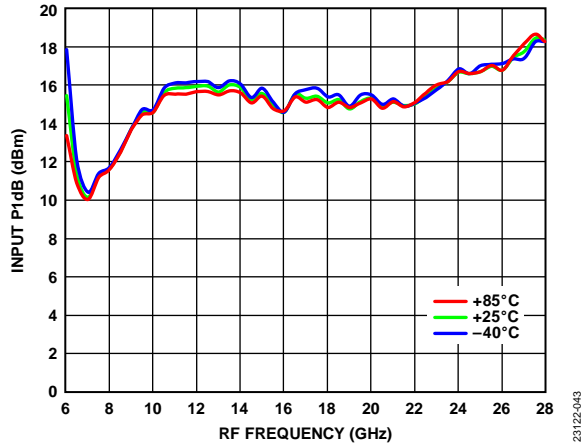

Figure 43. Input P1dB vs. RF Frequency at Various Temperatures, LO Drive = 18 dBm

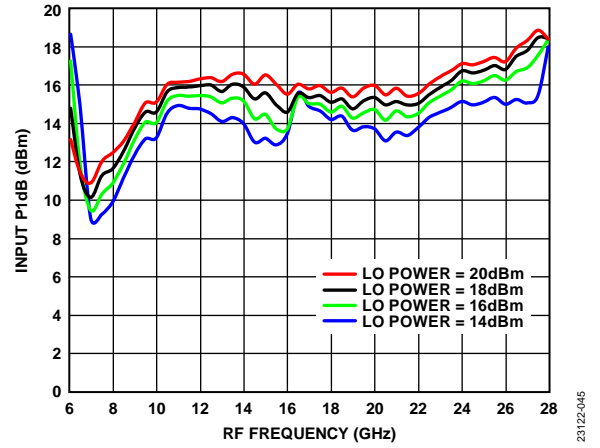

Figure 45. Input P1dB vs. RF Frequency at Various LO Drives, $T_A = 25^\circ\text{C}$

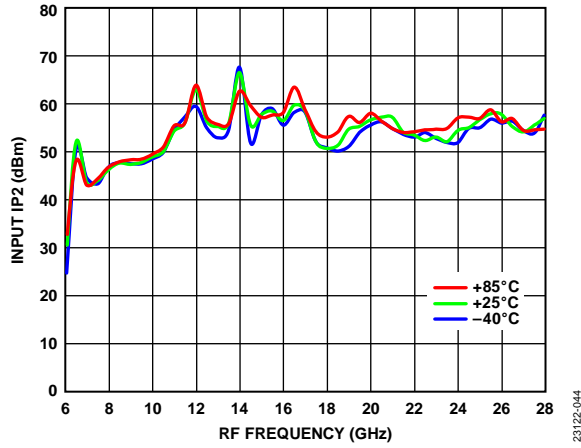

Figure 44. Input IP2 vs. RF Frequency at Various Temperatures, LO Drive = 18 dBm

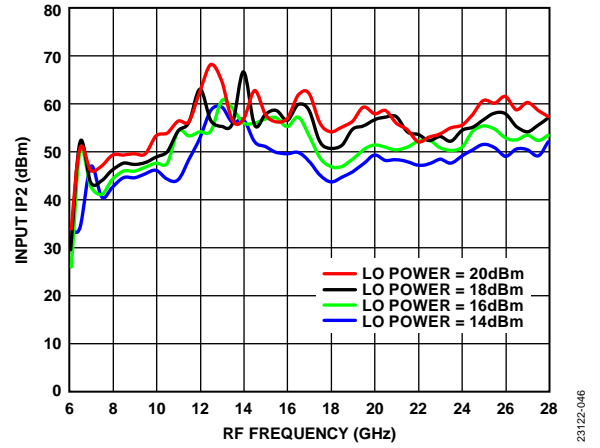

Figure 46. Input IP2 vs. RF Frequency at Various LO Drives, $T_A = 25^\circ\text{C}$

DOWNCONVERTER PERFORMANCE: IF = 2500 MHz, UPPER SIDEBAND (LOW-SIDE LO)

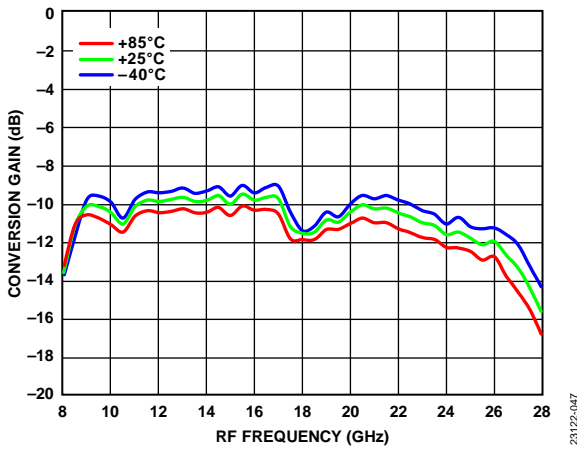

Figure 47. Conversion Gain vs. RF Frequency at Various Temperatures, LO Drive = 18 dBm

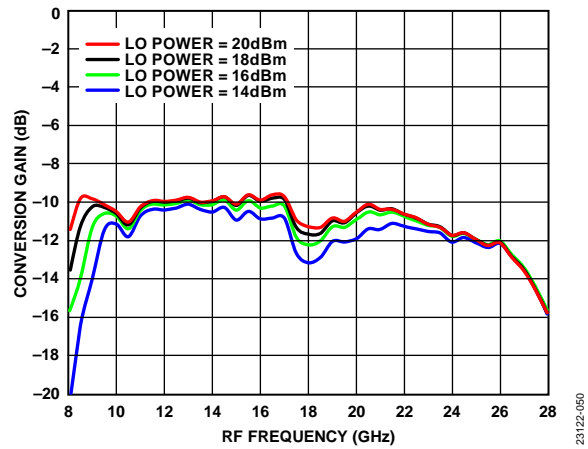

Figure 50. Conversion Gain vs. RF Frequency at Various LO Drives, $T_A = 25^\circ\text{C}$

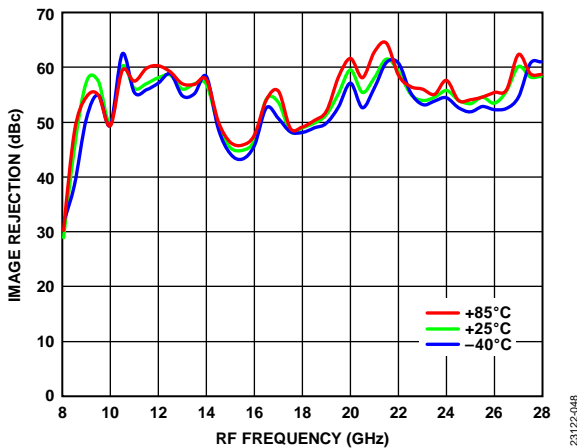

Figure 48. Image Rejection vs. RF Frequency at Various Temperatures, LO Drive = 18 dBm

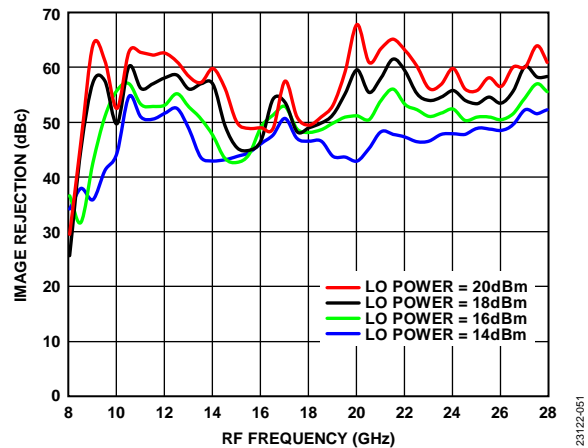

Figure 51. Image Rejection vs. RF Frequency at Various LO Drives, $T_A = 25^\circ\text{C}$

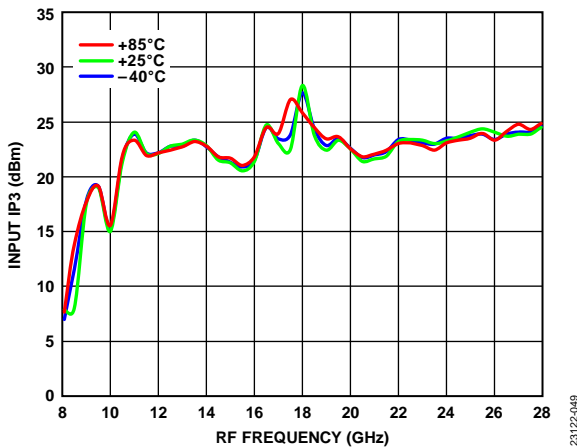

Figure 49. Input IP3 vs. RF Frequency at Various Temperatures, LO Drive = 18 dBm

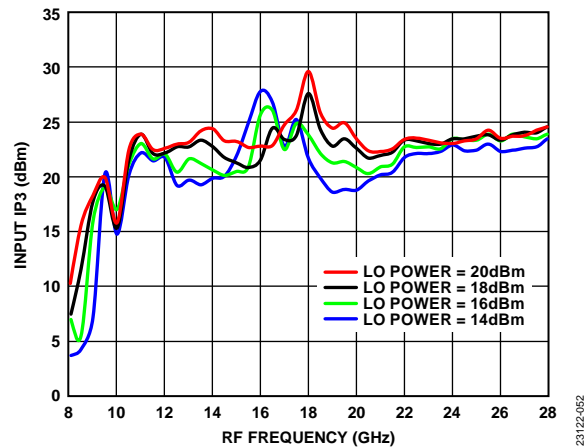

Figure 52. Input IP3 vs. RF Frequency at Various LO Drives, $T_A = 25^\circ\text{C}$

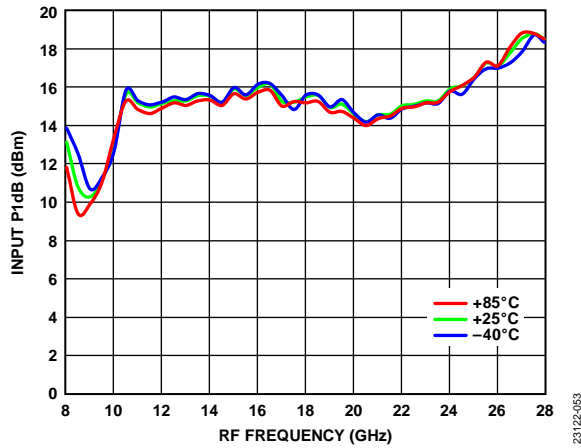

Figure 53. Input P1dB vs. RF Frequency at Various Temperatures, LO Drive = 18 dBm

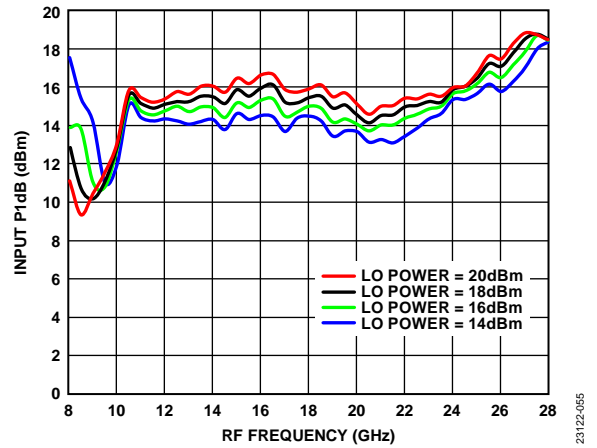

Figure 55. Input P1dB vs. RF Frequency at Various LO Drives, $T_A = 25^\circ\text{C}$

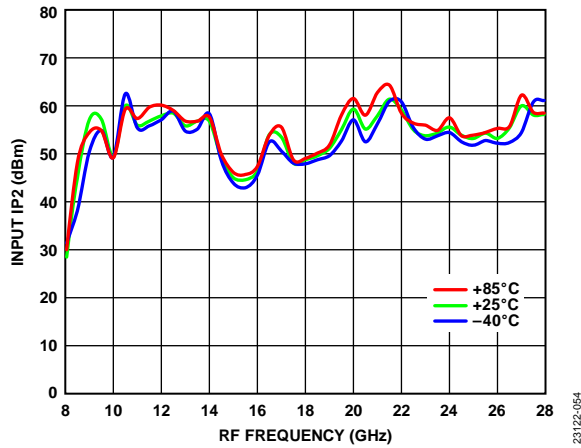

Figure 54. Input IP2 vs. RF Frequency at Various Temperatures, LO Drive = 18 dBm

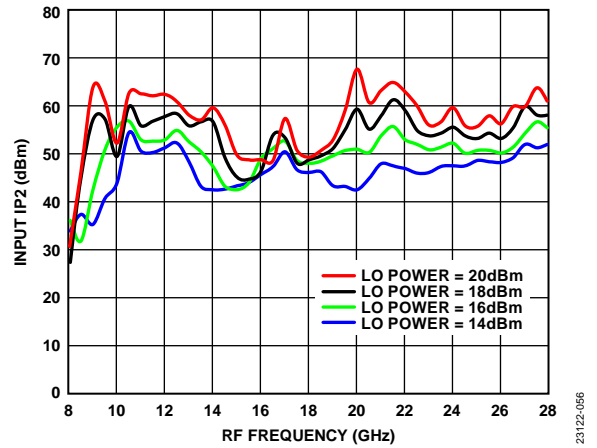

Figure 56. Input IP2 vs. RF Frequency at Various LO Drives, $T_A = 25^\circ\text{C}$

DOWNCONVERTER PERFORMANCE: IF = 5000 MHz, UPPER SIDEBAND (LOW-SIDE LO)

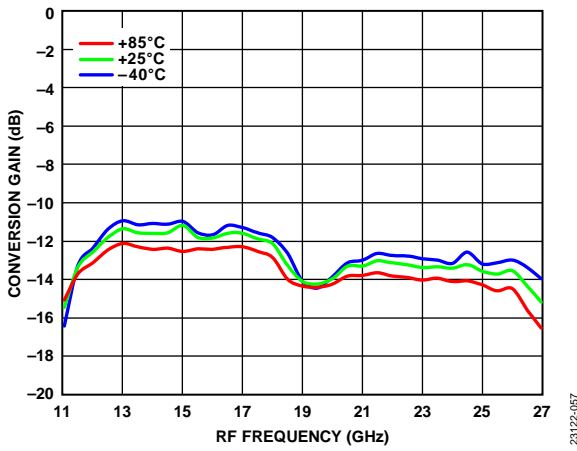

Figure 57. Conversion Gain vs. RF Frequency at Various Temperatures, LO Drive = 18 dBm

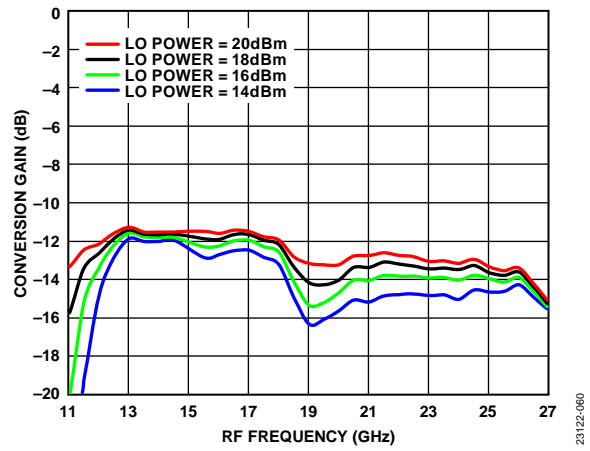

Figure 60. Conversion Gain vs. RF Frequency at Various LO Drives, $T_A = 25^\circ\text{C}$

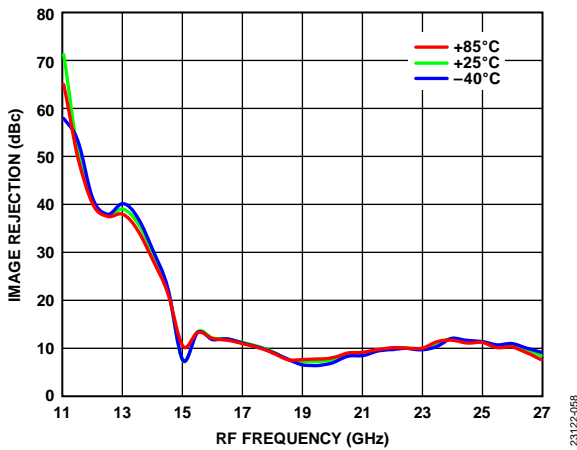

Figure 58. Image Rejection vs. RF Frequency at Various Temperatures, LO Drive = 18 dBm

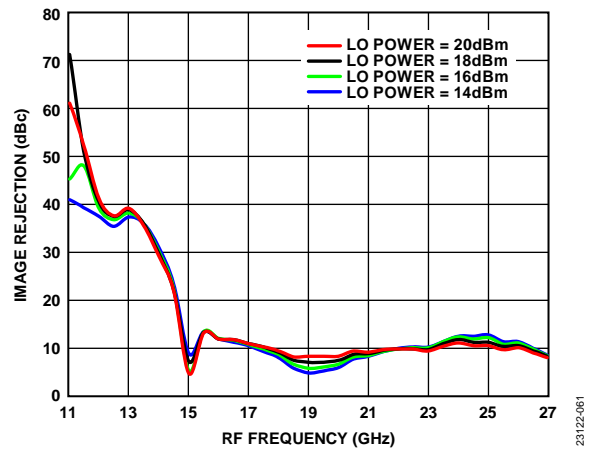

Figure 61. Image Rejection vs. RF Frequency at Various LO Drives, $T_A = 25^\circ\text{C}$

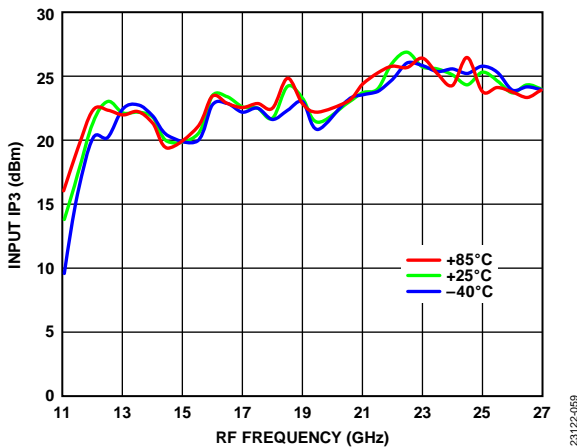

Figure 59. Input IP3 vs. RF Frequency at Various Temperatures, LO Drive = 18 dBm

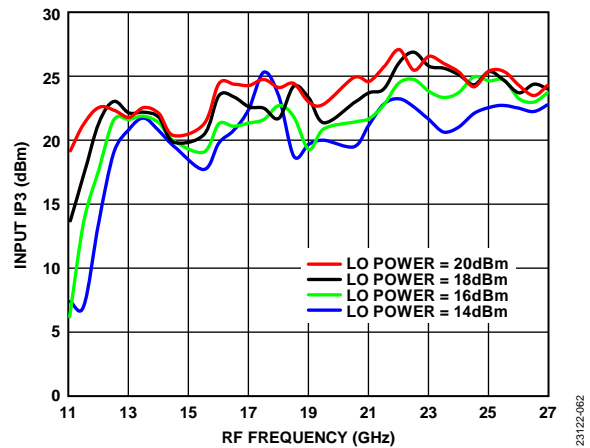

Figure 62. Input IP3 vs. RF Frequency at Various LO Drives, $T_A = 25^\circ\text{C}$

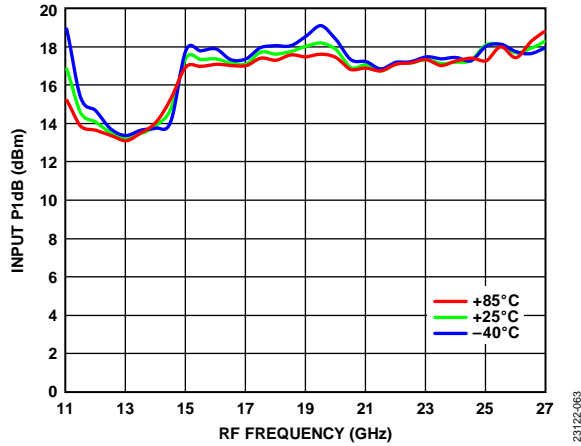

Figure 63. Input P1dB vs. RF Frequency at Various Temperatures, LO Drive = 18 dBm

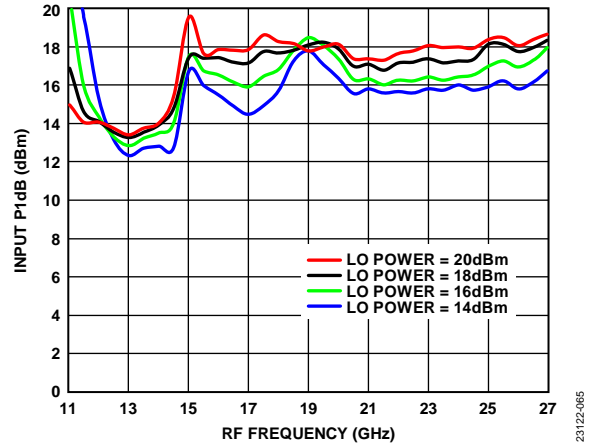

Figure 65. Input P1dB vs. RF Frequency at Various LO Drives, $T_A = 25^\circ\text{C}$

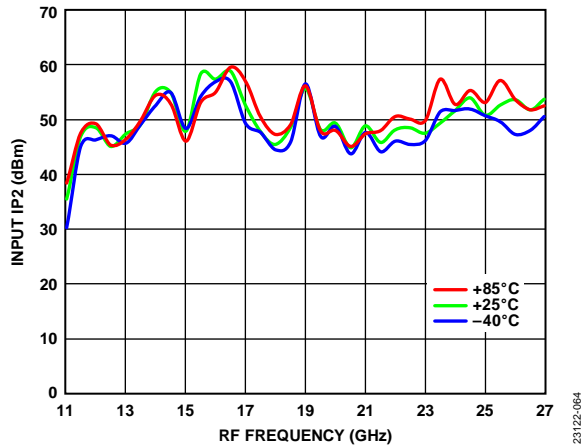

Figure 64. Input IP2 vs. RF Frequency at Various Temperatures, LO Drive = 18 dBm

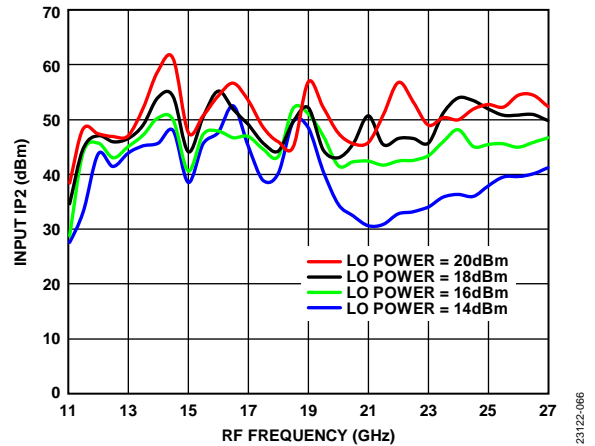

Figure 66. Input IP2 vs. RF Frequency at Various LO Drives, $T_A = 25^\circ\text{C}$

UPCONVERTER PERFORMANCE: IF = 100 MHz, LOWER SIDEBAND (HIGH-SIDE LO)

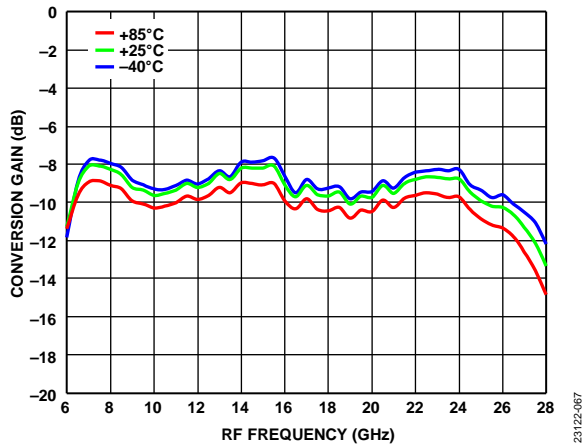

Figure 67. Conversion Gain vs. RF Frequency at Various Temperatures, LO Drive = 18 dBm

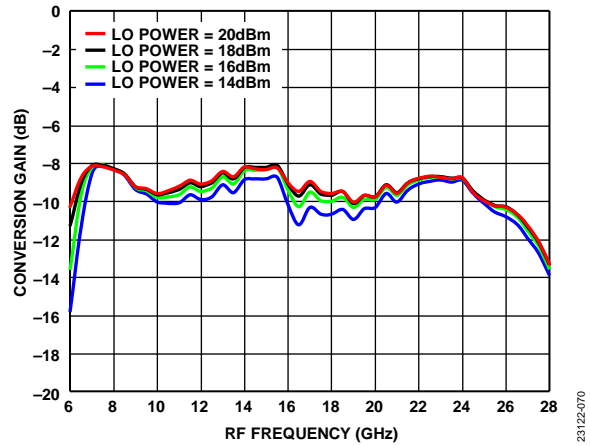

Figure 70. Conversion Gain vs. RF Frequency at Various LO Drives, $T_A = 25^\circ\text{C}$

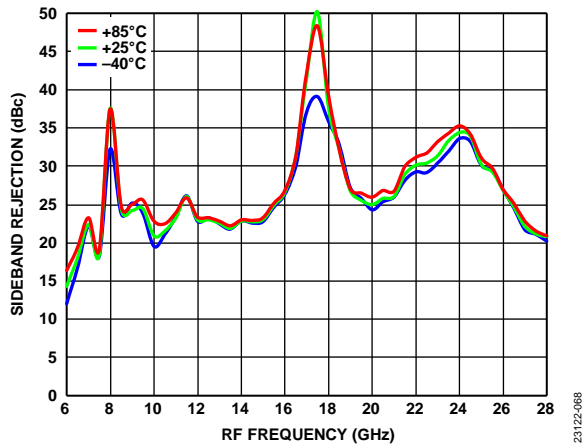

Figure 68. Sideband Rejection vs. RF Frequency at Various Temperatures, LO Drive = 18 dBm

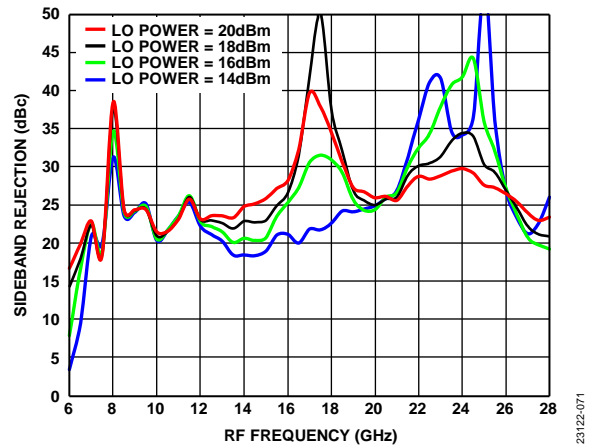

Figure 71. Sideband Rejection vs. RF Frequency at Various LO Drives, $T_A = 25^\circ\text{C}$

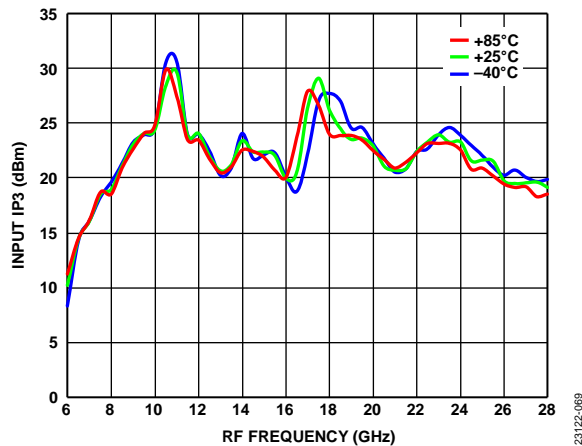

Figure 69. Input IP3 vs. RF Frequency at Various Temperatures, LO Drive = 18 dBm

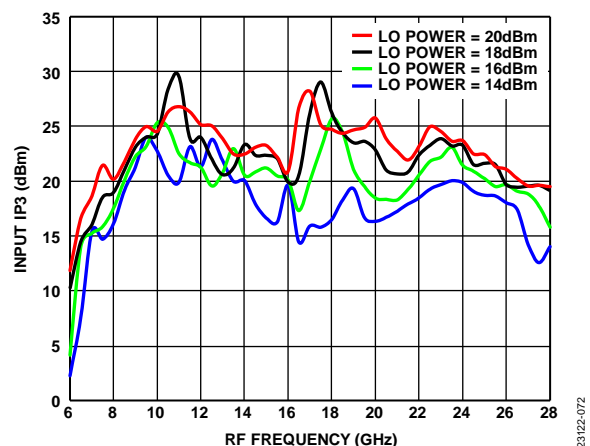

Figure 72. Input IP3 vs. RF Frequency at Various LO Drives, $T_A = 25^\circ\text{C}$

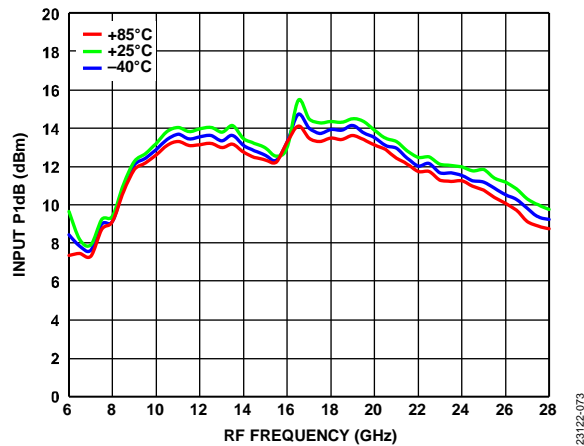

Figure 73. Input P1dB vs. RF Frequency at Various Temperatures, LO Drive = 18 dBm

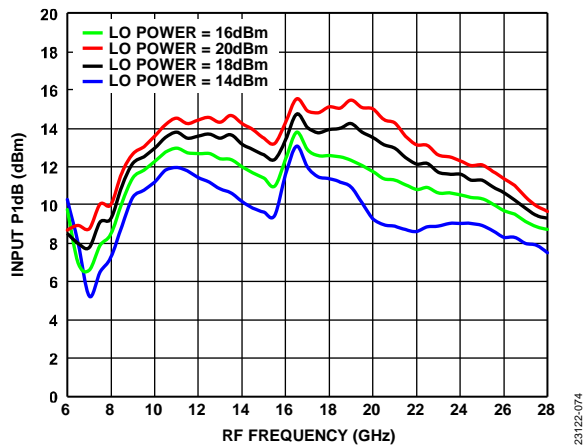

Figure 74. Input P1dB vs. RF Frequency at Various LO Drives, TA = 25°C

UPCONVERTER PERFORMANCE: IF = 2500 MHz, LOWER SIDEBAND (HIGH-SIDE LO)

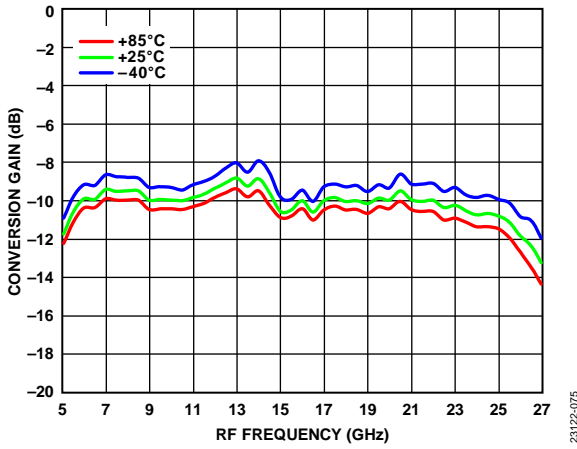

Figure 75. Conversion Gain vs. RF Frequency at Various Temperatures, LO Drive = 18 dBm

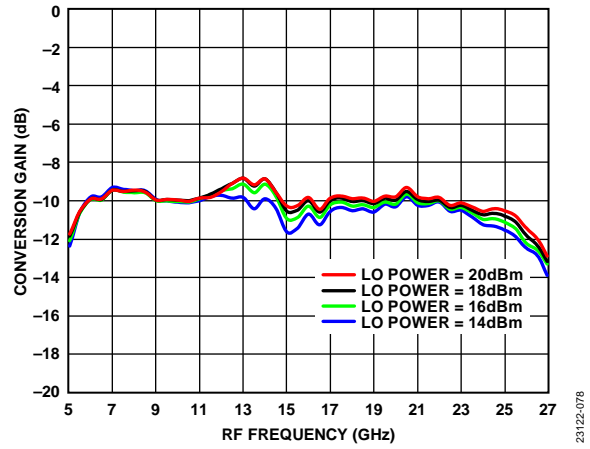

Figure 78. Conversion Gain vs. RF Frequency at Various LO Drives, $T_A = 25^\circ\text{C}$

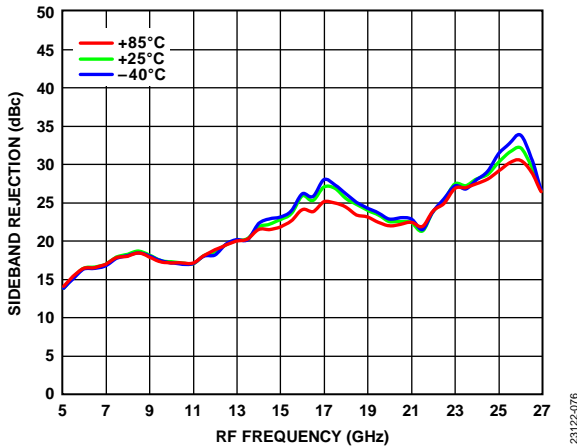

Figure 76. Sideband Rejection vs. RF Frequency at Various Temperatures, LO Drive = 18 dBm

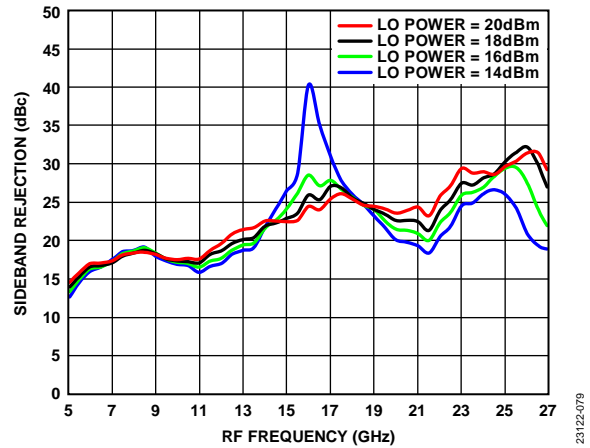

Figure 79. Sideband Rejection vs. RF Frequency at Various LO Drives, $T_A = 25^\circ\text{C}$

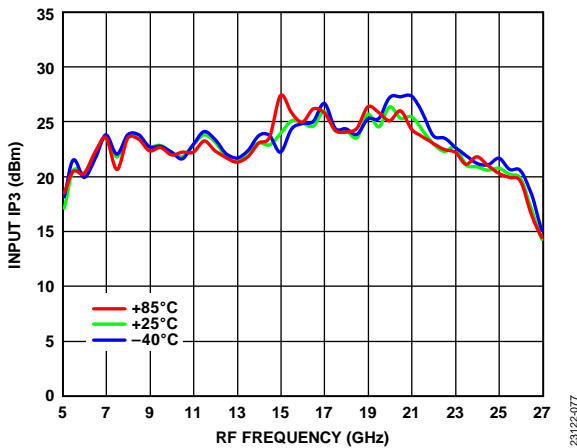

Figure 77. Input IP3 vs. RF Frequency at Various Temperatures, LO Drive = 18 dBm

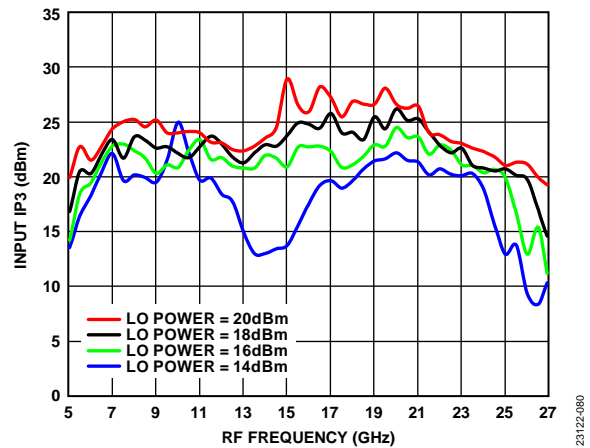

Figure 80. Input IP3 vs. RF Frequency at Various LO Drives, $T_A = 25^\circ\text{C}$

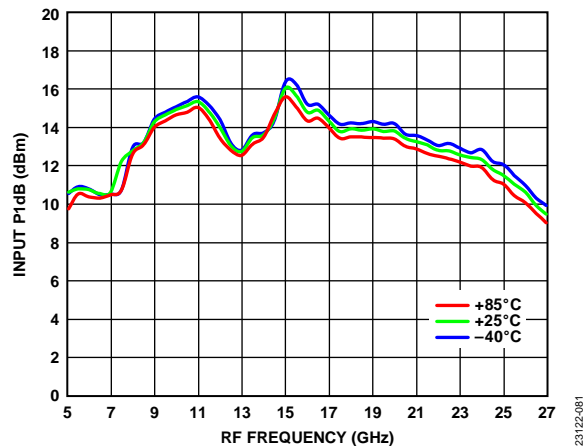

Figure 81. Input P1dB vs. RF Frequency at Various Temperatures, LO Drive = 18 dBm

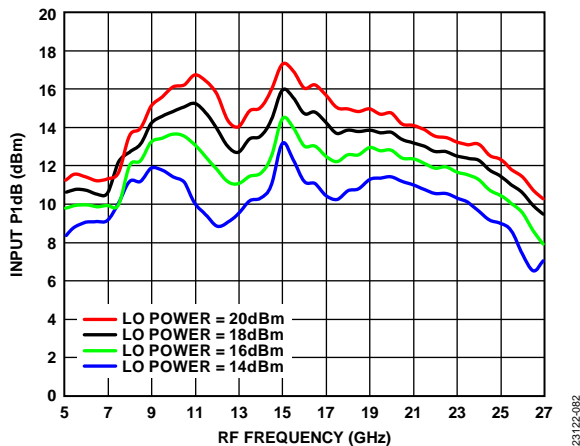

Figure 82. Input P1dB vs. RF Frequency at Various LO Drives, $T_A = 25^\circ\text{C}$

UPCONVERTER PERFORMANCE: IF = 5000 MHz, LOWER SIDEBAND (HIGH-SIDE LO)

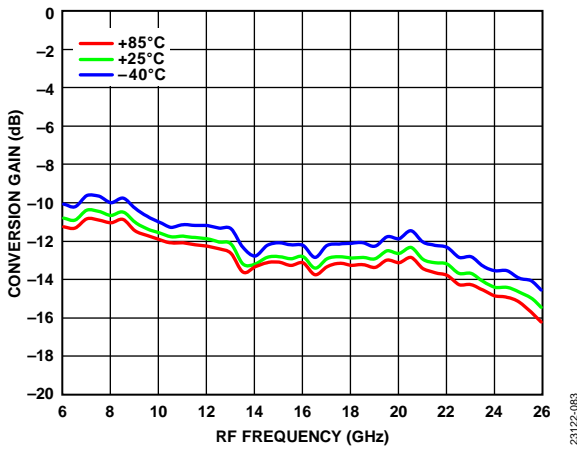

Figure 83. Conversion Gain vs. RF Frequency at Various Temperatures, LO Drive = 18 dBm

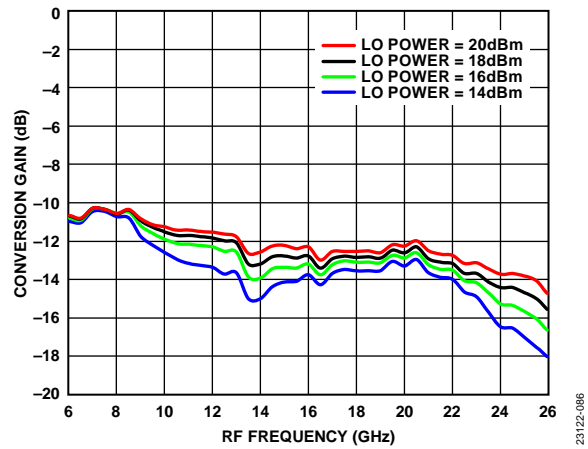

Figure 86. Conversion Gain vs. RF Frequency at Various LO Drives, $T_A = 25^\circ\text{C}$

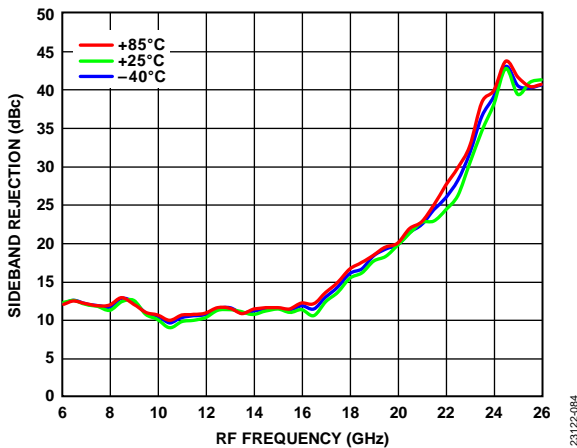

Figure 84. Sideband Rejection vs. RF Frequency at Various Temperatures, LO Drive = 18 dBm

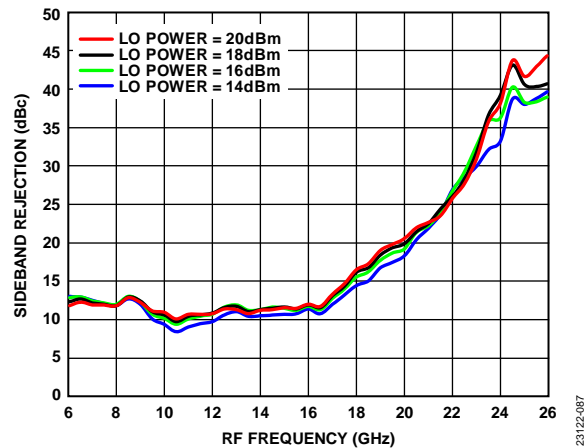

Figure 87. Sideband Rejection vs. RF Frequency at Various LO Drives, $T_A = 25^\circ\text{C}$

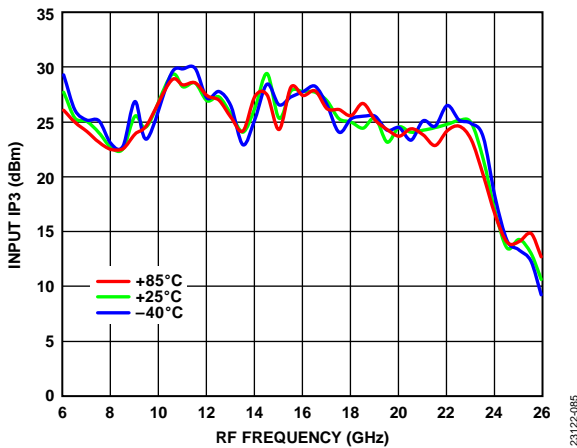

Figure 85. Input IP3 vs. RF Frequency at Various Temperatures, LO Drive = 18 dBm

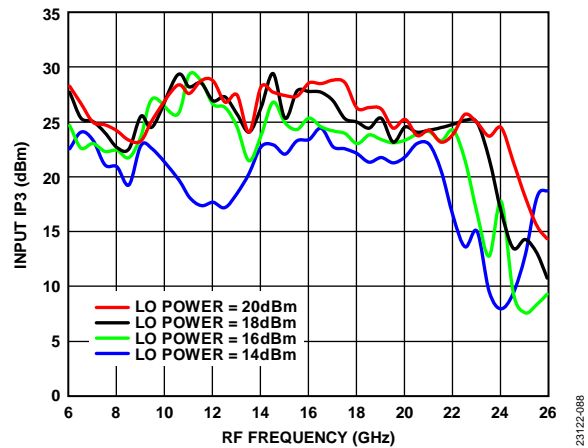

Figure 88. Input IP3 vs. RF Frequency at Various LO Drives, $T_A = 25^\circ\text{C}$

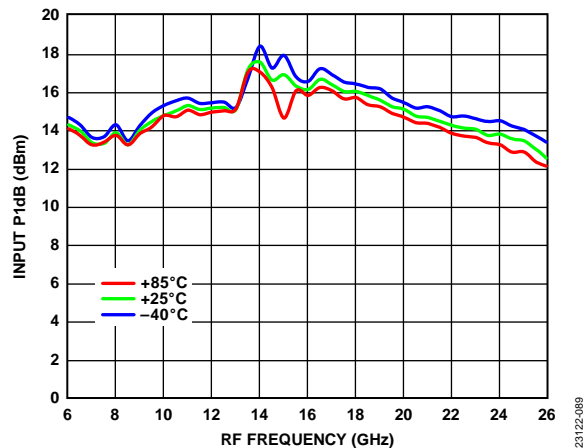

Figure 89. Input P1dB vs. RF Frequency at Various Temperatures, LO Drive = 18 dBm

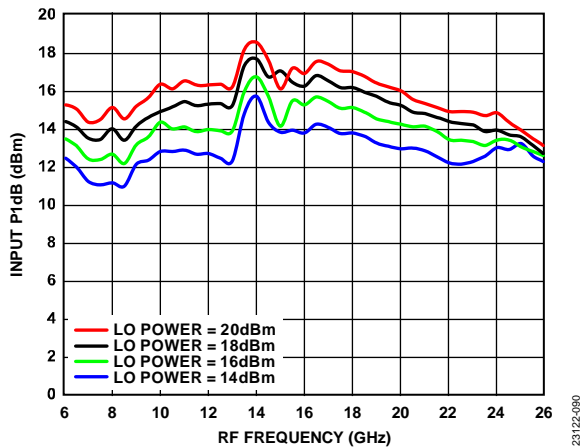

Figure 90. Input P1dB vs. RF Frequency at Various LO Drives, TA = 25°C

UPCONVERTER PERFORMANCE: IF = 100 MHz, UPPER SIDEBAND (LOW-SIDE LO)

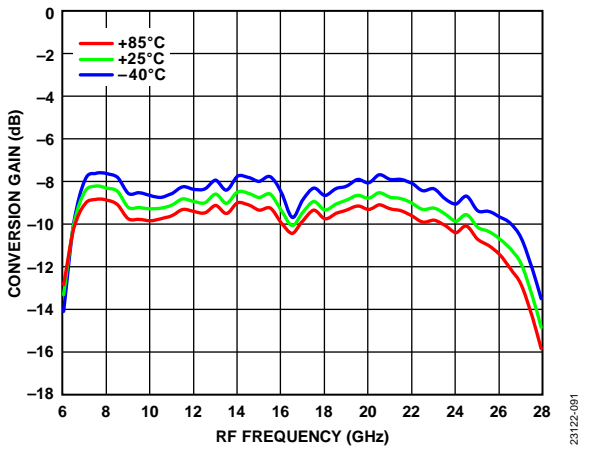

Figure 91. Conversion Gain vs. RF Frequency at Various Temperatures, LO Drive = 18 dBm

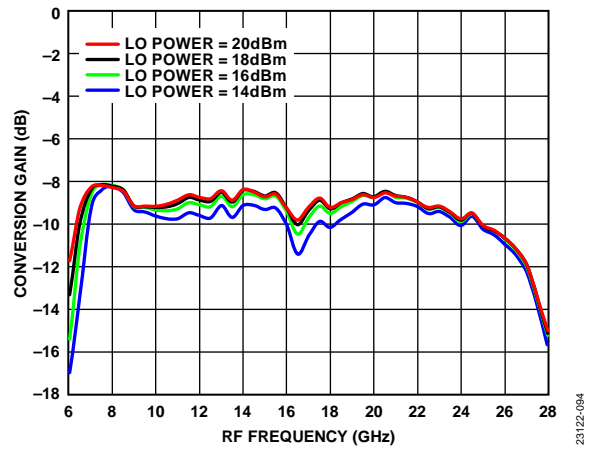

Figure 94. Conversion Gain vs. RF Frequency at Various LO Drives, $T_A = 25^\circ\text{C}$

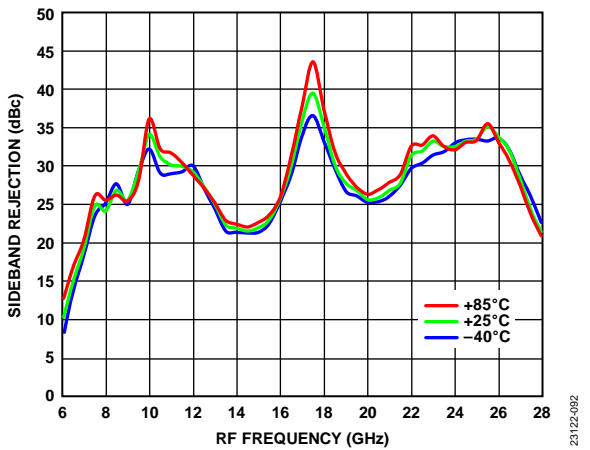

Figure 92. Sideband Rejection vs. RF Frequency at Various Temperatures, LO Drive = 18 dBm

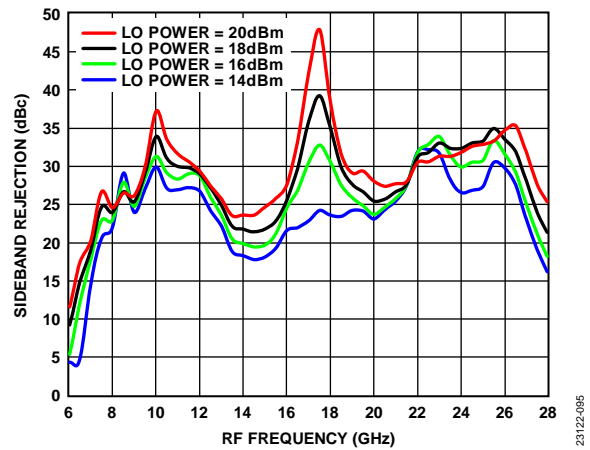

Figure 95. Sideband Rejection vs. RF Frequency at Various LO Drives, $T_A = 25^\circ\text{C}$

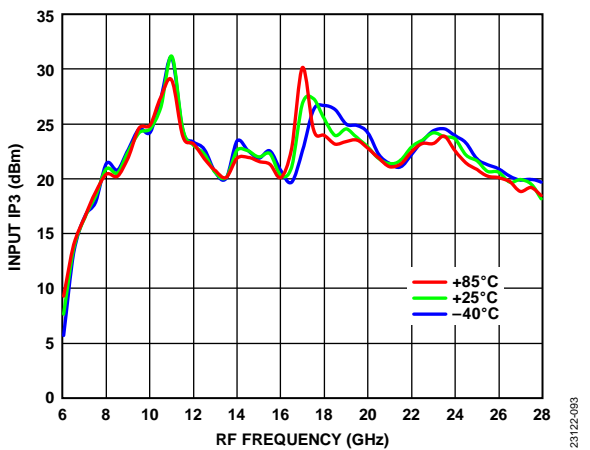

Figure 93. Input IP3 vs. RF Frequency at Various Temperatures, LO Drive = 18 dBm

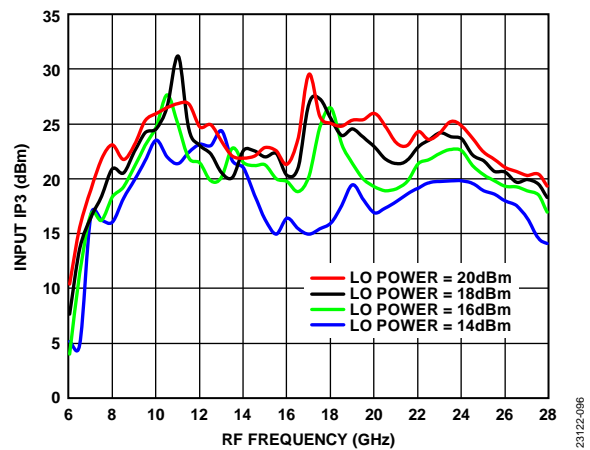

Figure 96. Input IP3 vs. RF Frequency at Various LO Drives, $T_A = 25^\circ\text{C}$

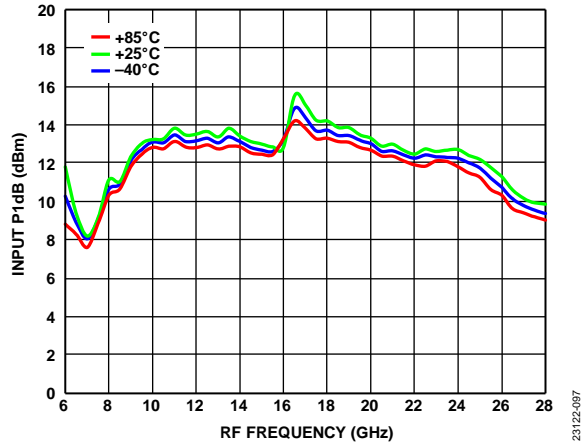

Figure 97. Input P1dB vs. RF Frequency at Various Temperatures, LO Drive = 18 dBm

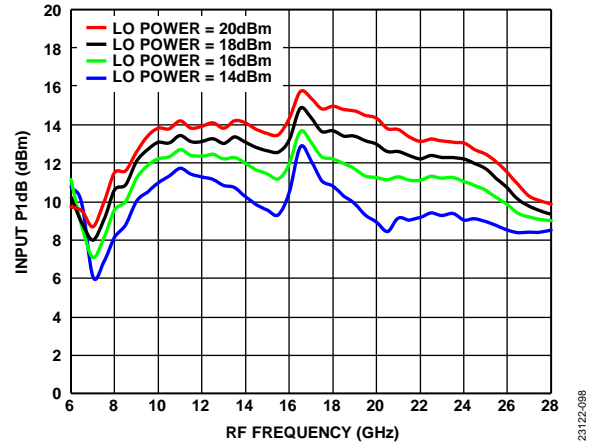

Figure 98. Input P1dB vs. RF Frequency at Various LO Drives, TA = 25°C

UPCONVERTER PERFORMANCE: IF = 2500 MHz, UPPER SIDEBAND (LOW-SIDE LO)

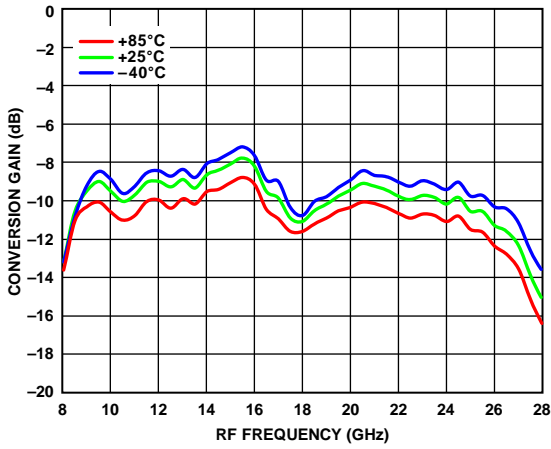

Figure 99. Conversion Gain vs. RF Frequency at Various Temperatures, LO Drive = 18 dBm

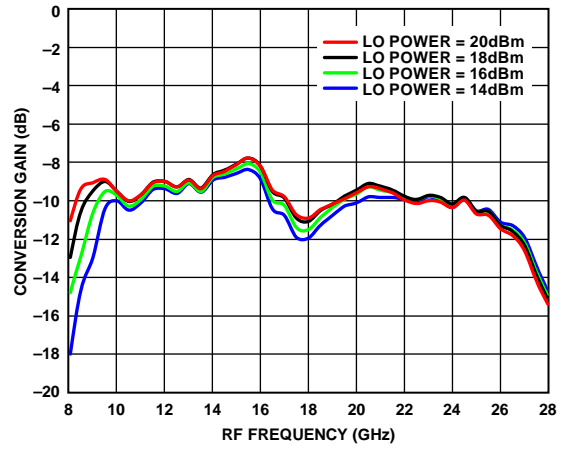

Figure 102. Conversion Gain vs. RF Frequency at Various LO Drives, $T_A = 25^\circ\text{C}$

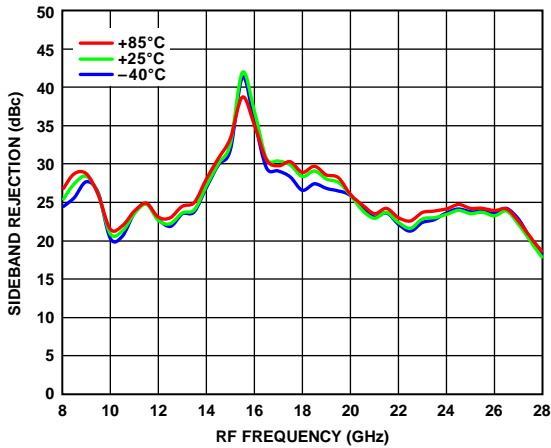

Figure 100. Sideband Rejection vs. RF Frequency at Various Temperatures, LO Drive = 18 dBm

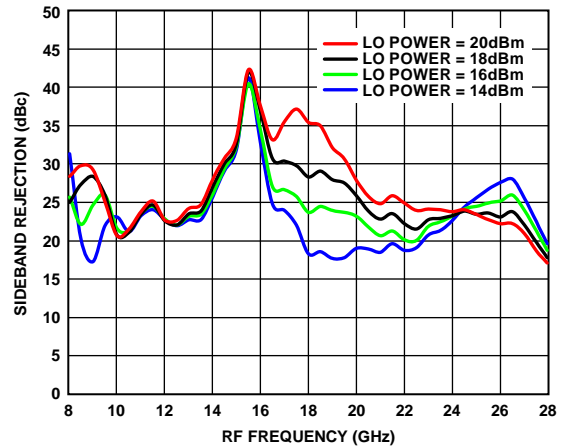

Figure 103. Sideband Rejection vs. RF Frequency at Various LO Drives, $T_A = 25^\circ\text{C}$

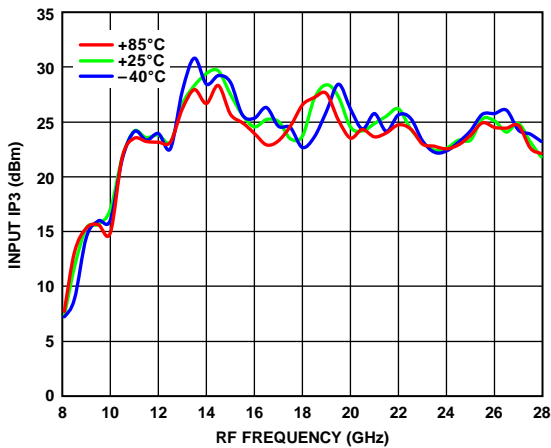

Figure 101. Input IP3 vs. RF Frequency at Various Temperatures, LO Drive = 18 dBm

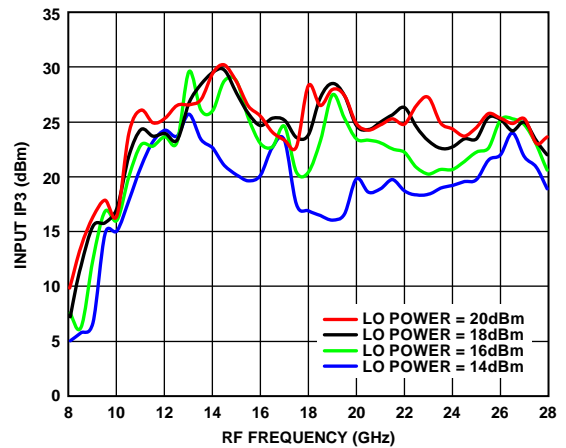

Figure 104. Input IP3 vs. RF Frequency at Various LO Drives, $T_A = 25^\circ\text{C}$

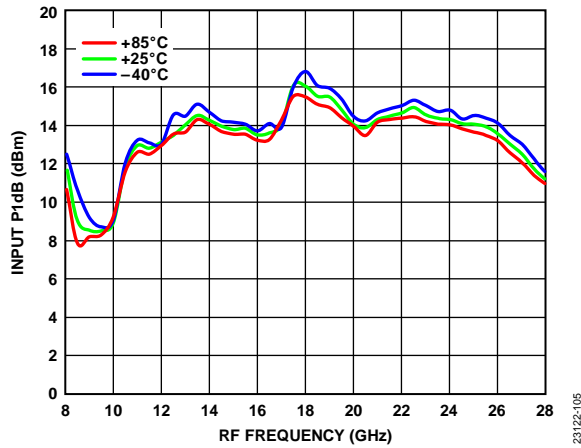

Figure 105. Input P1dB vs. RF Frequency at Various Temperatures, LO Drive = 18 dBm

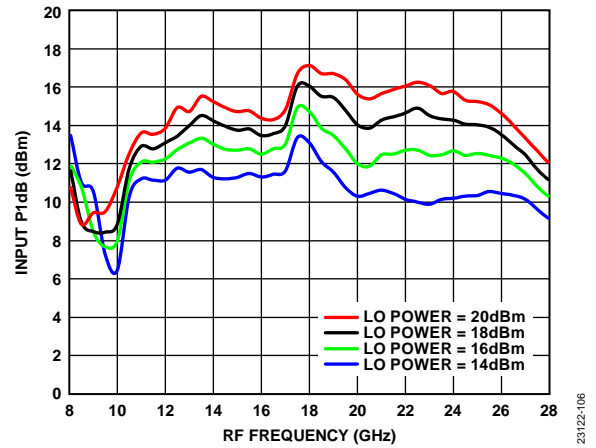

Figure 106. Input P1dB vs. RF Frequency at Various LO Drives, $T_A = 25^\circ\text{C}$

UPCONVERTER PERFORMANCE: IF = 5000 MHz, UPPER SIDEBAND (LOW-SIDE LO)

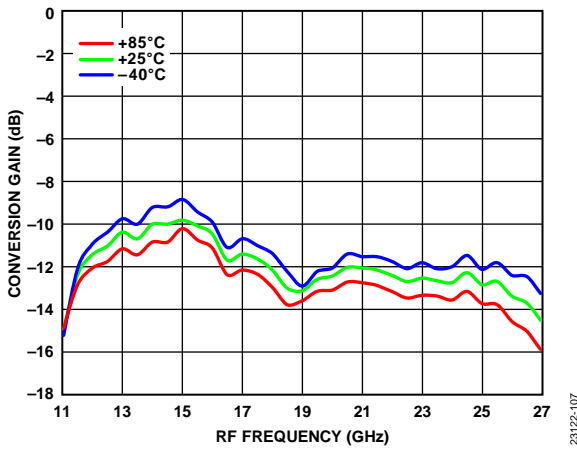

Figure 107. Conversion Gain vs. RF Frequency at Various Temperatures, LO Drive = 18 dBm

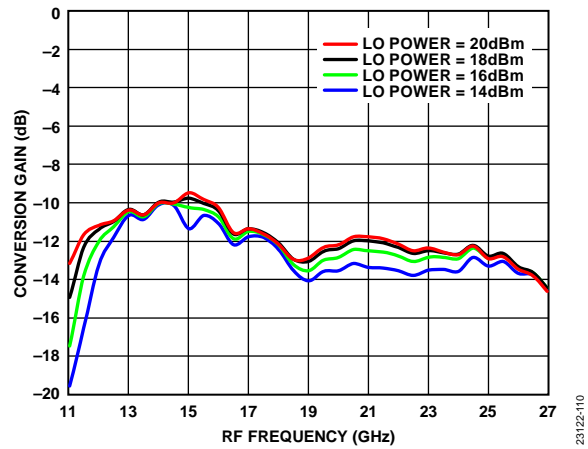

Figure 110. Conversion Gain vs. RF Frequency at Various LO Drives, $T_A = 25^\circ\text{C}$

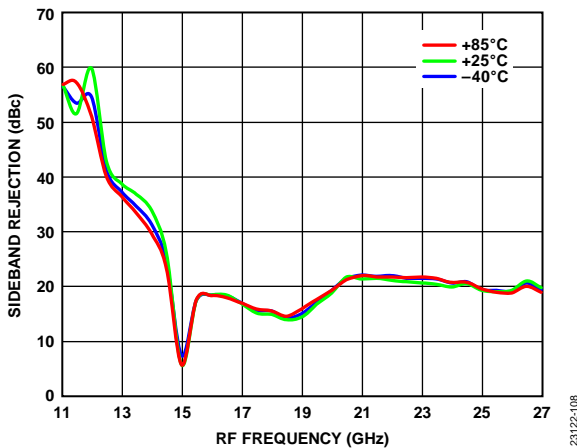

Figure 108. Sideband Rejection vs. RF Frequency at Various Temperatures, LO Drive = 18 dBm

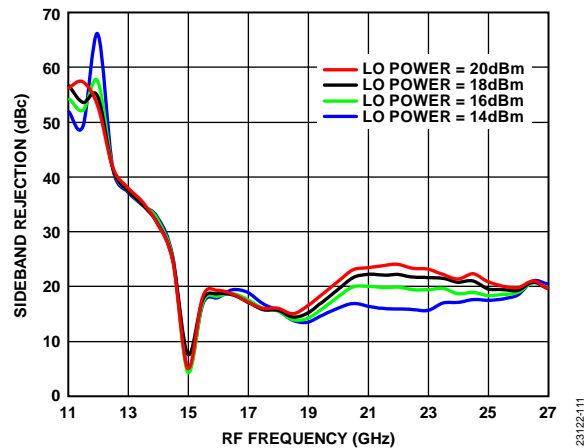

Figure 111. Sideband Rejection vs. RF Frequency at Various LO Drives, $T_A = 25^\circ\text{C}$

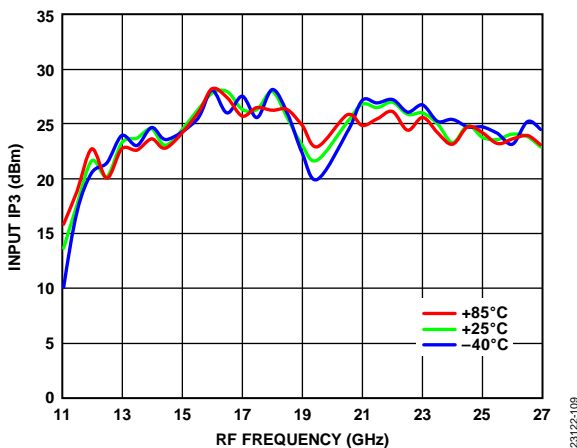

Figure 109. Input IP3 vs. RF Frequency at Various Temperatures, LO Drive = 18 dBm

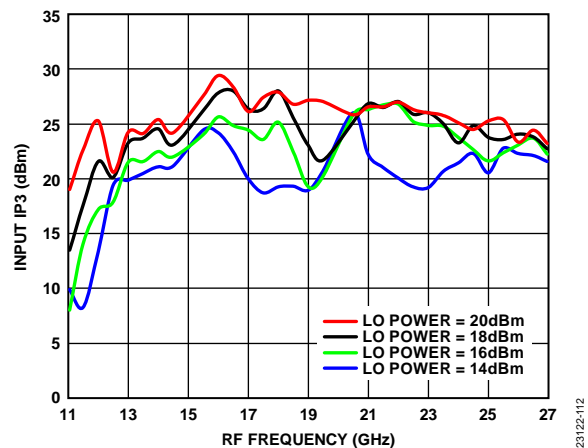

Figure 112. Input IP3 vs. RF Frequency at Various LO Drives, $T_A = 25^\circ\text{C}$

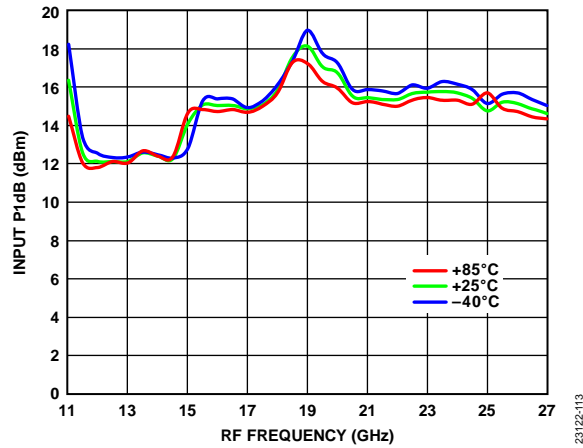

Figure 113. Input P1dB vs. RF Frequency at Various Temperatures, LO Drive = 18 dBm

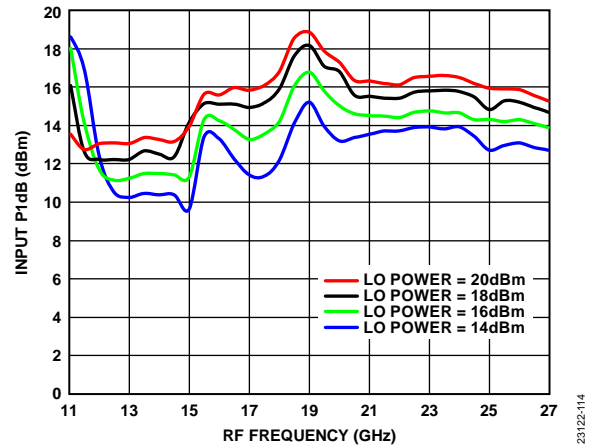

Figure 114. Input P1dB vs. RF Frequency at Various LO Drives, $T_A = 25^\circ\text{C}$

ISOLATION AND RETURN LOSS

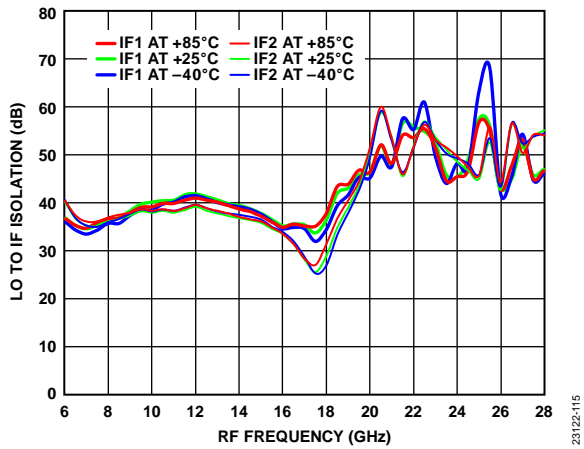

Figure 115. LO to IF Isolation vs. RF Frequency at Various IFx Temperatures, IF = 100 MHz, LO Drive = 18 dBm

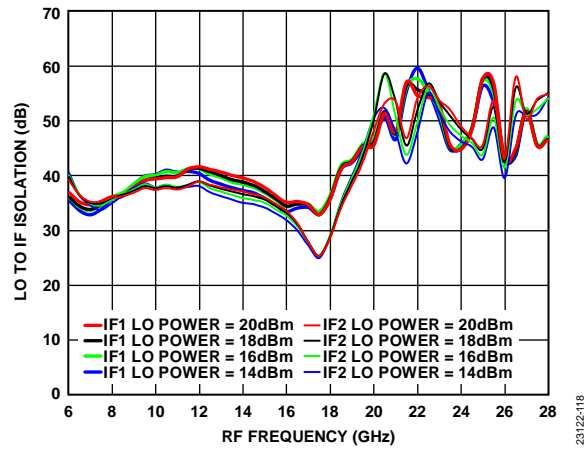

Figure 118. LO to IF Isolation vs. RF Frequency at Various IFx LO Drives, IF = 100 MHz, T_A = 25°C

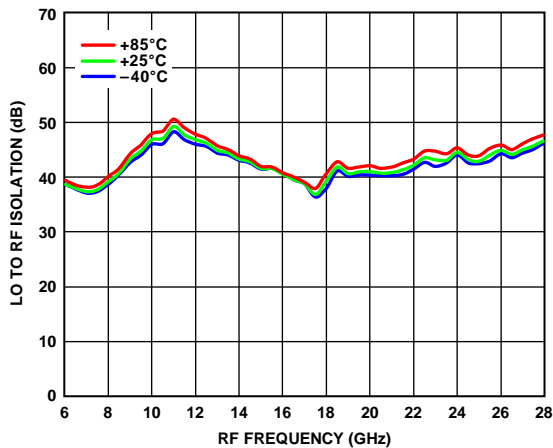

Figure 116. LO to RF Isolation vs. RF Frequency at Various Temperatures, IF = 100 MHz, LO Drive = 18 dBm

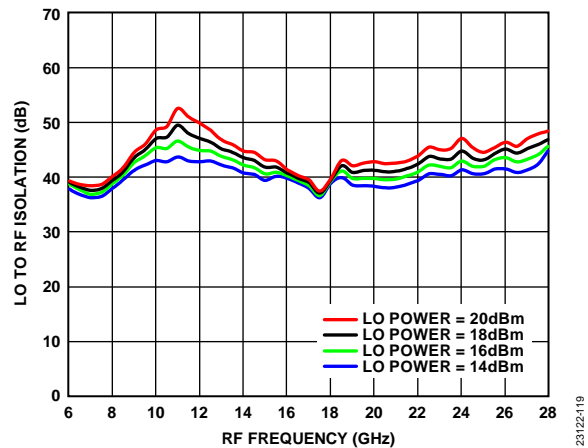

Figure 119. LO to RF Isolation vs. RF Frequency at Various LO Drives, IF = 100 MHz, T_A = 25°C

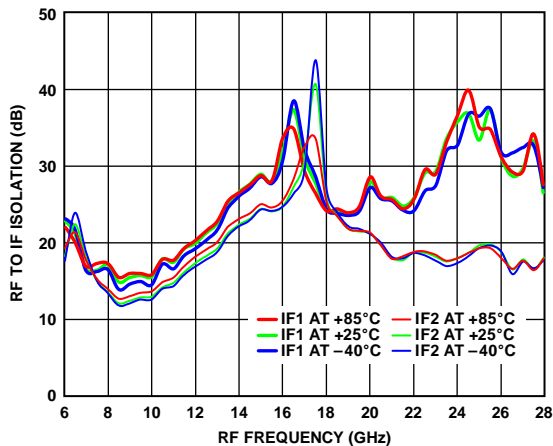

Figure 117. RF to IF Isolation vs. RF Frequency at Various IFx Temperatures, IF = 100 MHz, LO Drive = 18 dBm

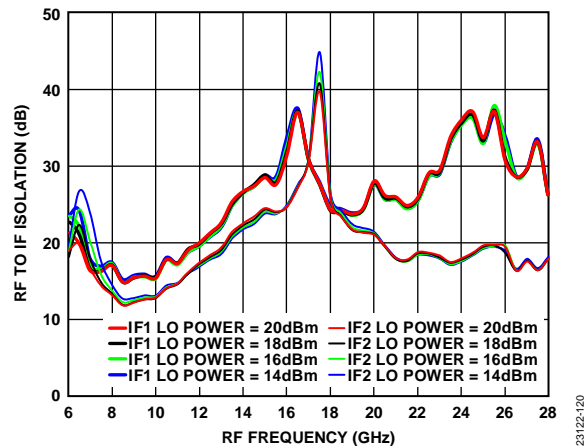

Figure 120. RF to IF Isolation vs. RF Frequency at Various IFx LO Drives, IF = 100 MHz, T_A = 25°C

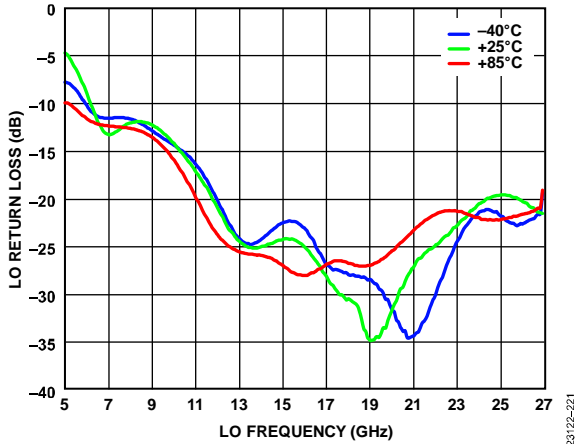

Figure 121. LO Return Loss vs. LO Frequency at Various Temperatures, LO Drive = 18 dBm

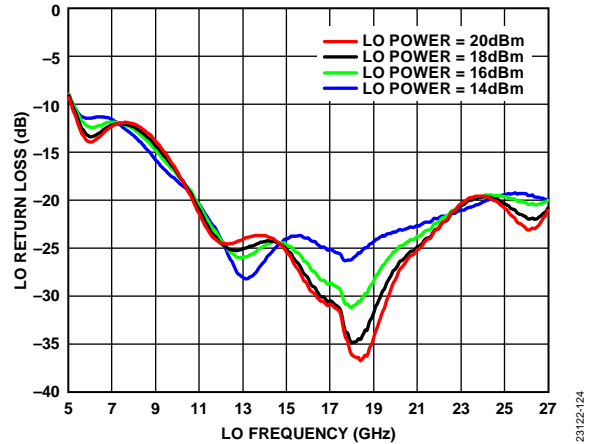

Figure 124. LO Return Loss vs. LO Frequency at Various LO Drives at $T_A = 25^\circ\text{C}$

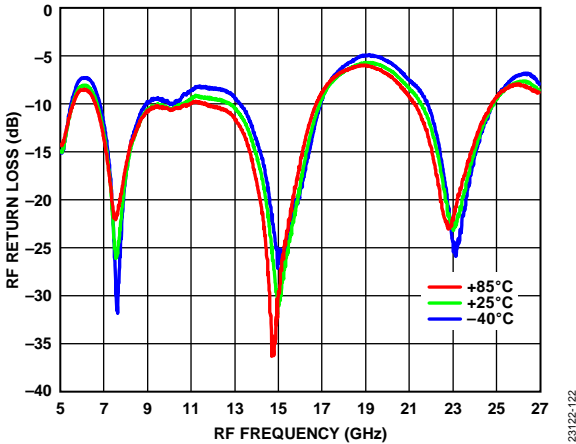

Figure 122. RF Return Loss vs. RF Frequency at Various Temperatures, LO Frequency = 16 GHz, LO Drive = 18 dBm

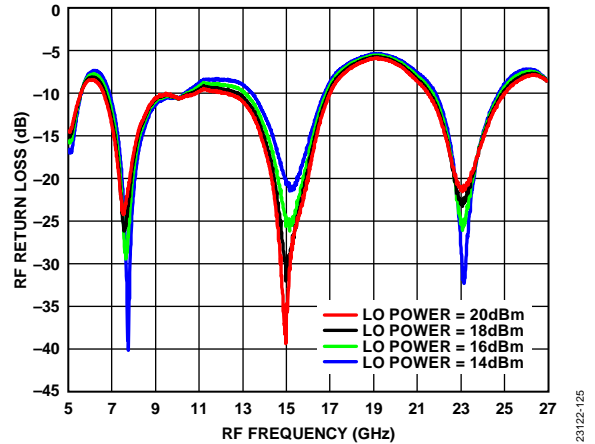

Figure 125. RF Return Loss vs. RF Frequency at Various LO Drives, LO Frequency = 16 GHz

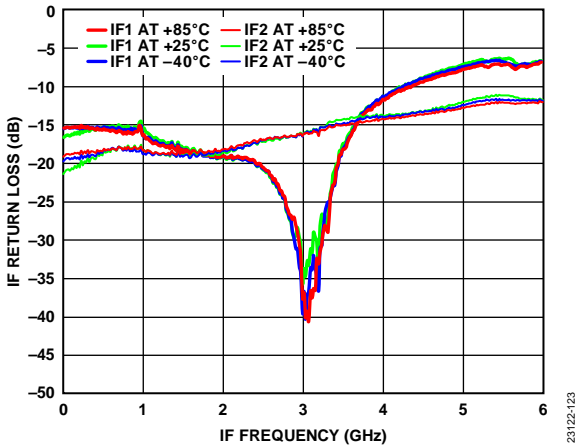

Figure 123. IF Return Loss vs. IF Frequency at Various IFx Temperatures, LO Frequency = 16 GHz, LO Drive = 18 dBm

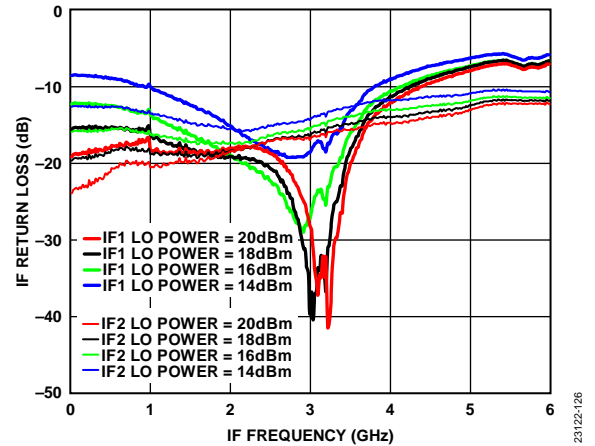

Figure 126. IF Return Loss vs. IF Frequency at Various IFx LO Drives, LO Frequency = 16 GHz

IF BANDWIDTH PERFORMANCE: DOWNCONVERTER, LOWER SIDEBAND (HIGH-SIDE LO)

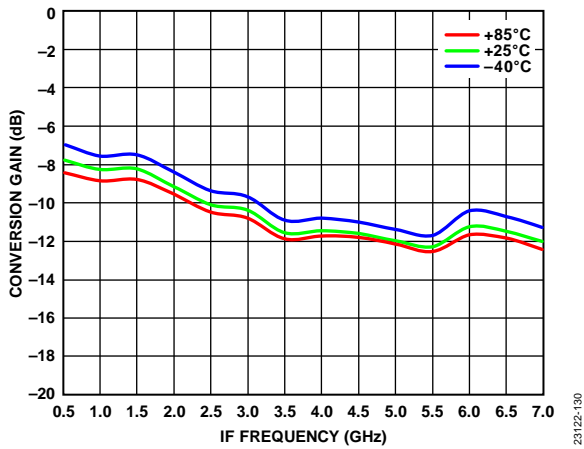

Figure 127. Conversion Gain vs. IF Frequency at Various Temperatures, LO Drive = 18 dBm at 16 GHz

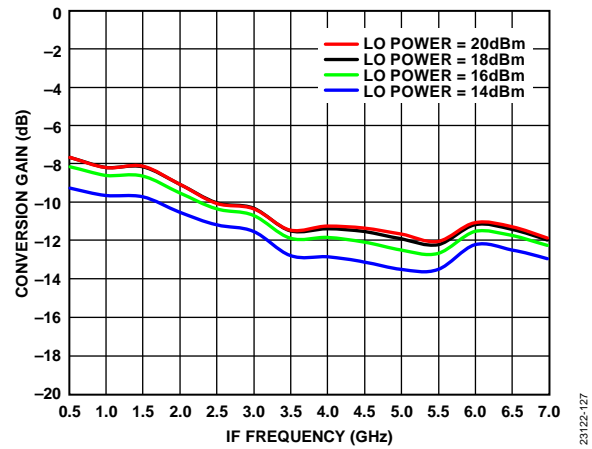

Figure 130. Conversion Gain vs. IF Frequency at Various LO Drives, LO Frequency = 16 GHz, T_A = 25°C

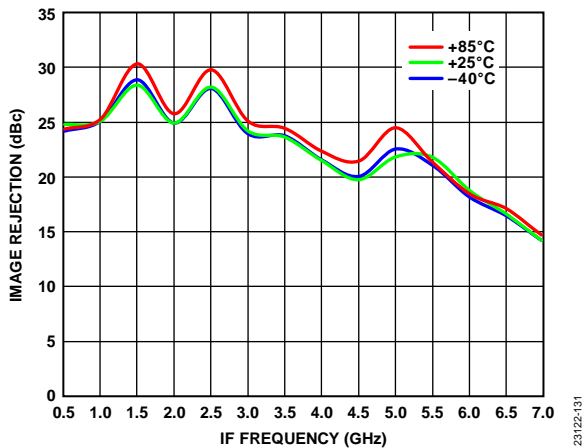

Figure 128. Image Rejection vs. IF Frequency at Various Temperatures, LO Drive = 18 dBm at 16 GHz

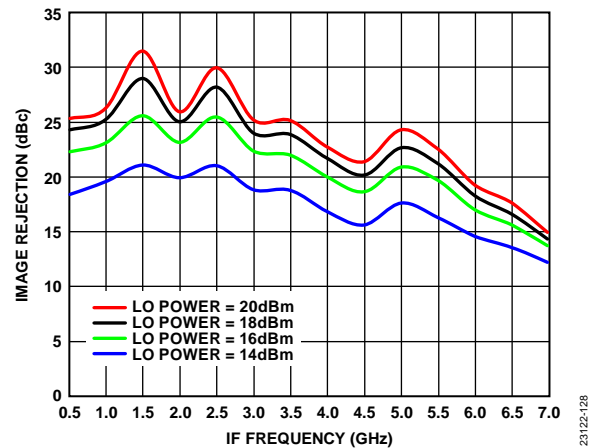

Figure 131. Image Rejection vs. IF Frequency at Various LO Drives, LO Frequency = 16 GHz, T_A = 25°C

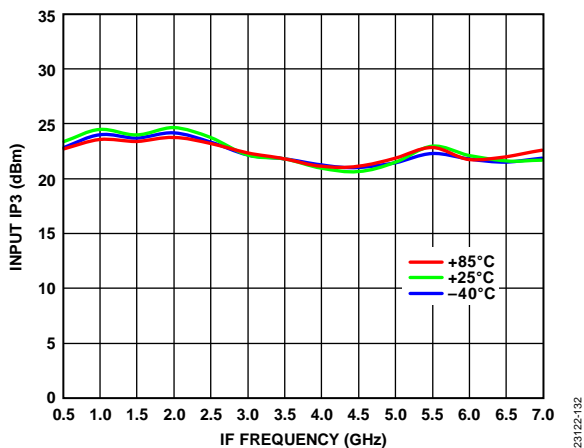

Figure 129. Input IP3 vs. IF Frequency at Various Temperatures, LO Drive = 18 dBm at 16 GHz

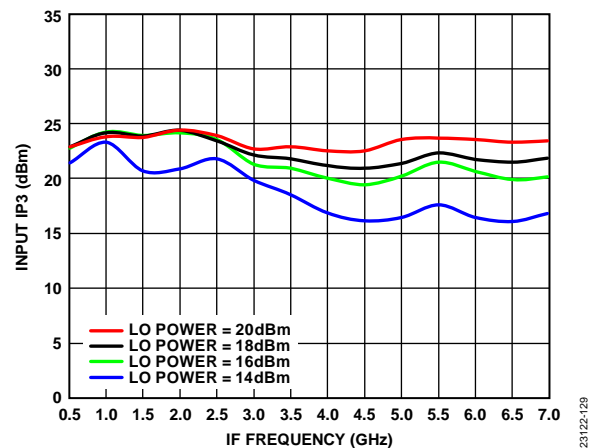

Figure 132. Input IP3 vs. IF Frequency at Various LO Drives, LO Frequency = 16 GHz, T_A = 25°C

IF BANDWIDTH PERFORMANCE: DOWNCONVERTER, UPPER SIDEBAND (LOW-SIDE LO)

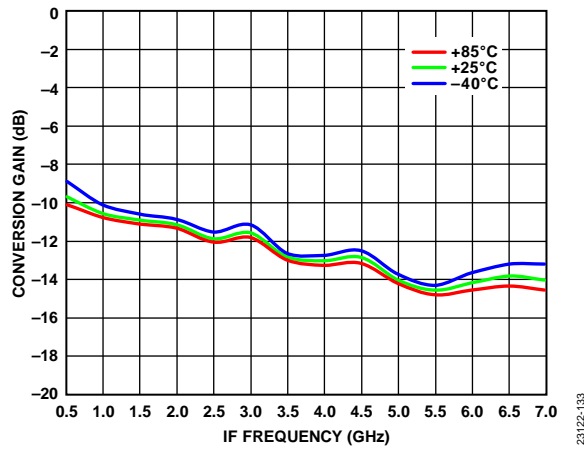

Figure 133. Conversion Gain vs. IF Frequency at Various Temperatures, LO Drive = 18 dBm at 16 GHz

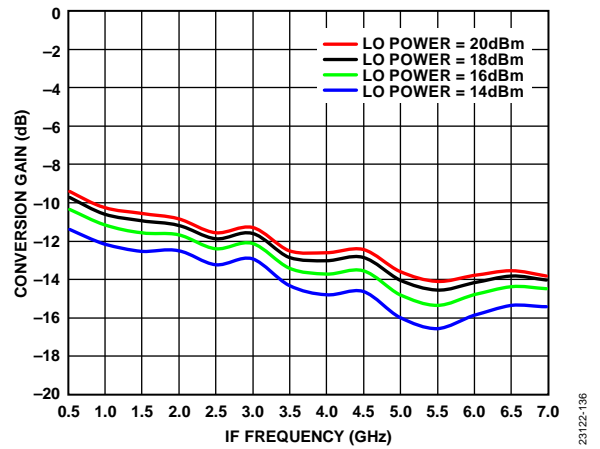

Figure 136. Conversion Gain vs. IF Frequency at Various LO Drives, LO Frequency = 16 GHz, $T_A = 25^\circ\text{C}$

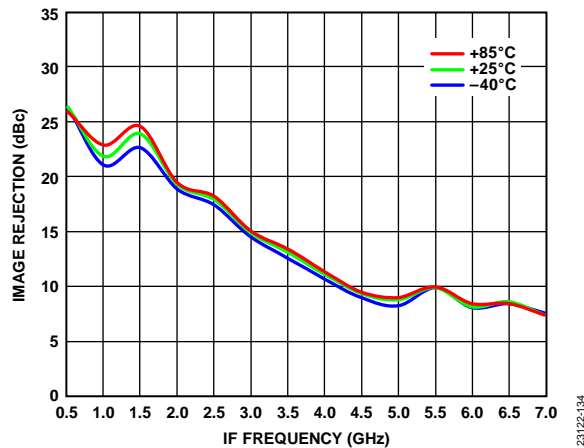

Figure 134. Image Rejection vs. IF Frequency at Various Temperatures, LO Drive = 18 dBm at 16 GHz

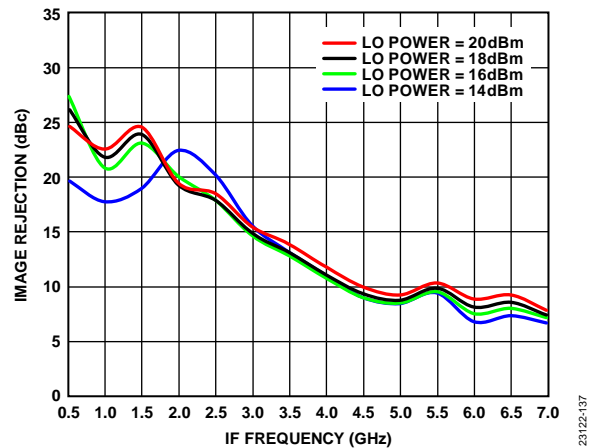

Figure 137. Image Rejection vs. IF Frequency at Various LO Drives, LO Frequency = 16 GHz, $T_A = 25^\circ\text{C}$

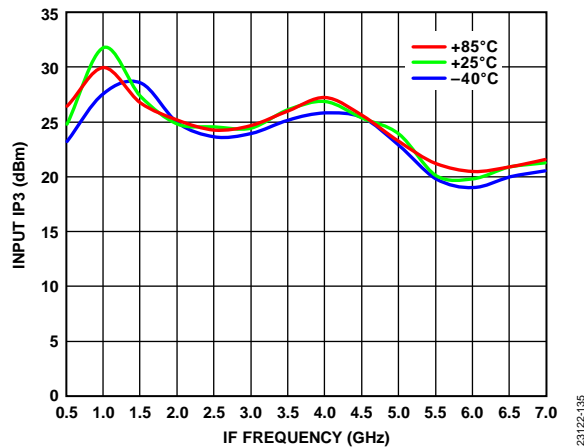

Figure 135. Input IP3 vs. IF Frequency at Various Temperatures, LO Drive = 18 dBm at 16 GHz

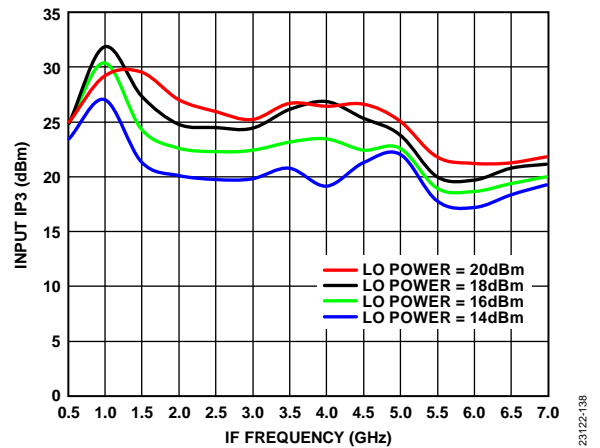

Figure 138. Input IP3 vs. IF Frequency at Various LO Drives, LO Frequency = 16 GHz, $T_A = 25^\circ\text{C}$

AMPLITUDE AND PHASE IMBALANCE PERFORMANCE: DOWNCONVERTER, LOWER SIDEBAND (HIGH-SIDE LO)

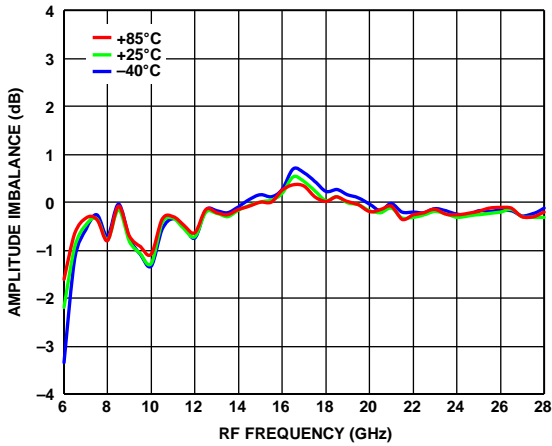

Figure 139. Amplitude Imbalance vs. RF Frequency at Various Temperatures, LO Drive = 18 dBm, IF = 100 MHz

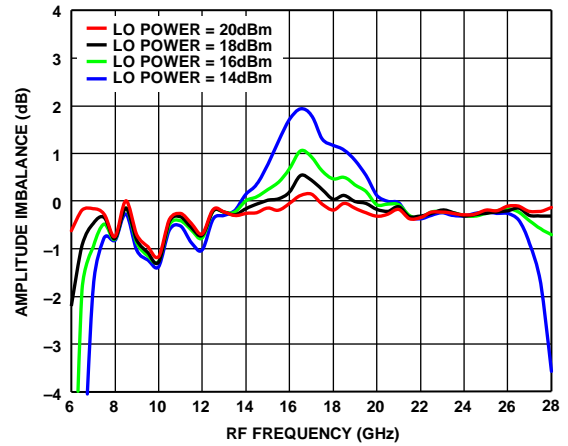

Figure 142. Amplitude Imbalance vs. RF Frequency at Various LO Drives, IF = 100 MHz, T_A = 25°C

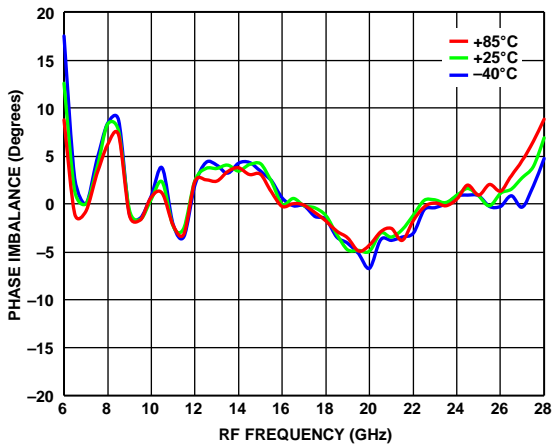

Figure 140. Phase Imbalance vs. RF Frequency at Various Temperatures, LO Drive = 18 dBm, IF = 100 MHz

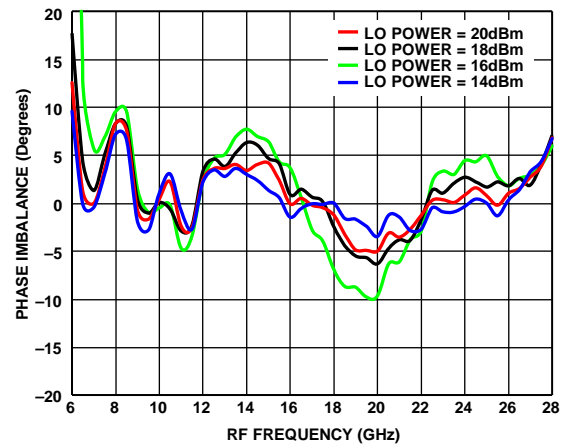

Figure 143. Phase Imbalance vs. RF Frequency at Various LO Drives, IF = 100 MHz, T_A = 25°C

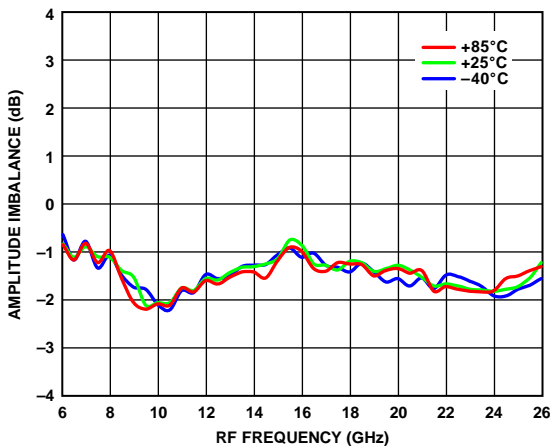

Figure 141. Amplitude Imbalance vs. RF Frequency at Various Temperatures, LO Drive = 18 dBm, IF = 2500 MHz

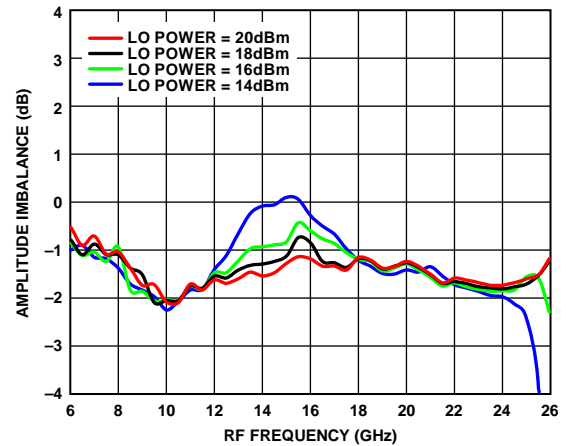

Figure 144. Amplitude Imbalance vs. RF Frequency at Various LO Drives, IF = 2500 MHz, T_A = 25°C

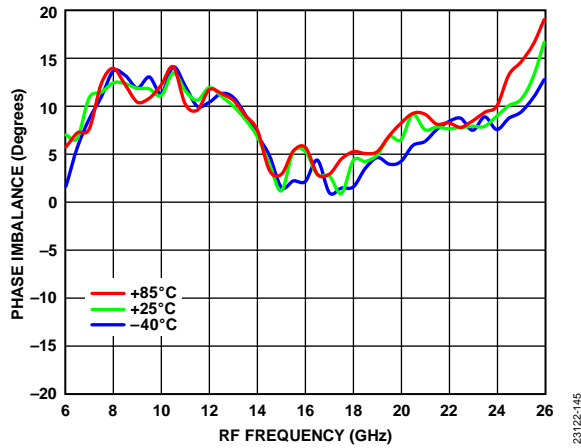

Figure 145. Phase Imbalance vs. RF Frequency at Various Temperatures, LO Drive = 18 dBm, IF = 2500 MHz

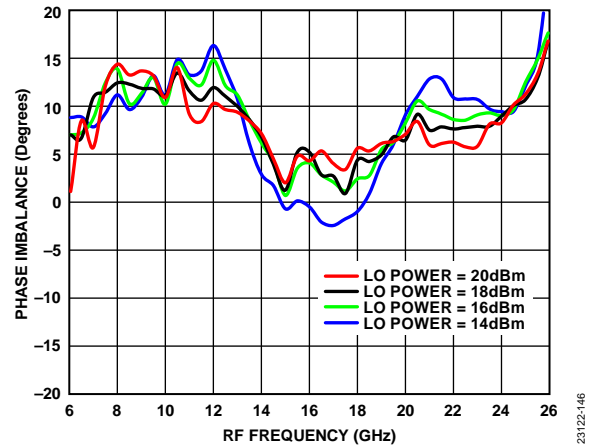

Figure 146. Phase Imbalance vs. RF Frequency at Various LO Drives, IF = 2500 MHz, T_A = 25°C

AMPLITUDE AND PHASE IMBALANCE PERFORMANCE: DOWNCONVERTER, UPPER SIDEBAND (LOW-SIDE LO)

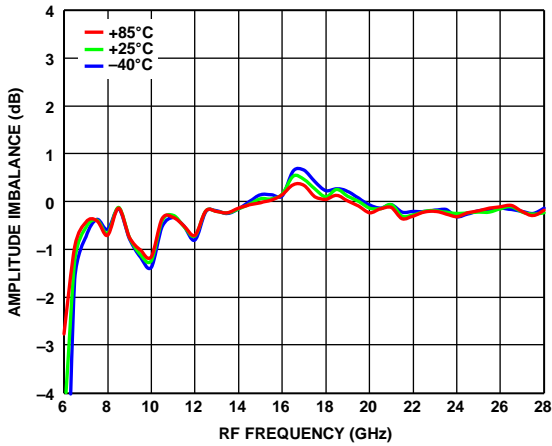

Figure 147. Amplitude Imbalance vs. RF Frequency at Various Temperatures, LO Drive = 18 dBm, IF = 100 MHz

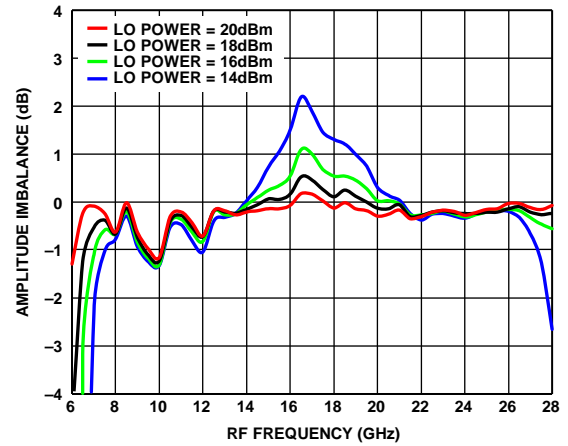

Figure 150. Amplitude Imbalance vs. RF Frequency at Various LO Drives, IF = 100 MHz, $T_A = 25^\circ\text{C}$

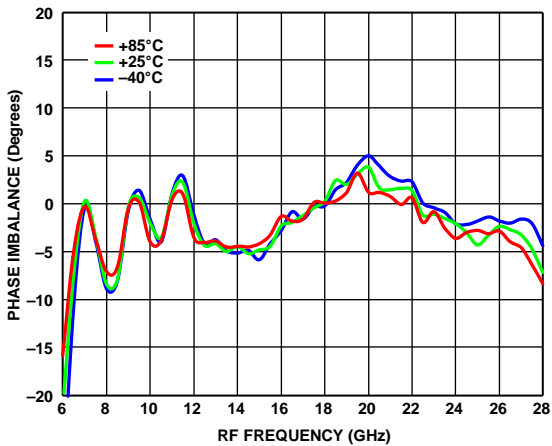

Figure 148. Phase Imbalance vs. RF Frequency at Various Temperatures, LO Drive = 18 dBm, IF = 100 MHz

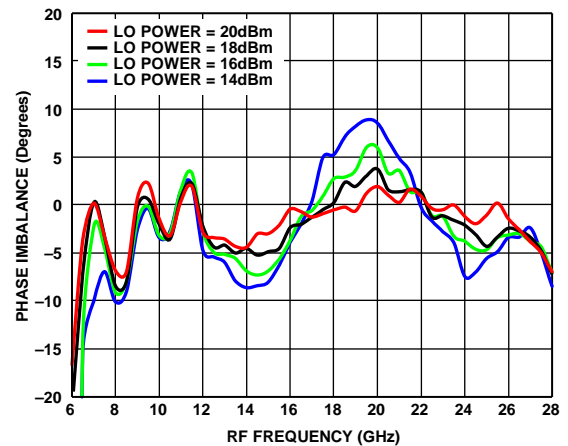

Figure 151. Phase Imbalance vs. RF Frequency at Various LO Drives, IF = 100 MHz, $T_A = 25^\circ\text{C}$

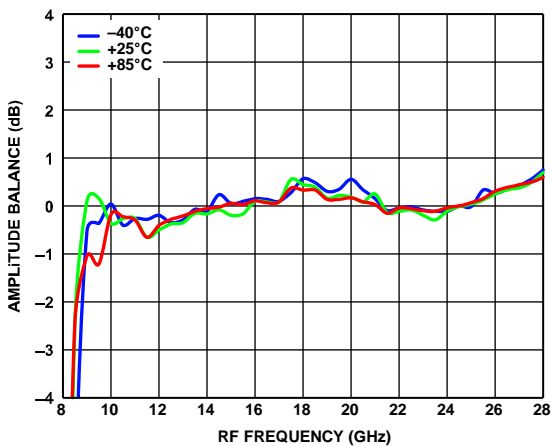

Figure 149. Amplitude Imbalance vs. RF Frequency at Various Temperatures, LO Drive = 18 dBm, IF = 2500 MHz

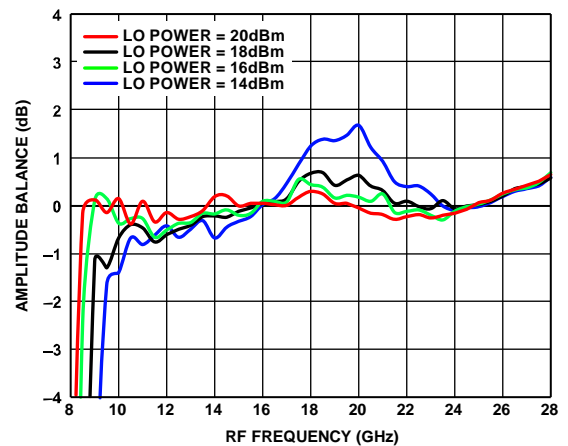

Figure 152. Amplitude Imbalance vs. RF Frequency at Various LO Drives, IF = 2500 MHz, $T_A = 25^\circ\text{C}$

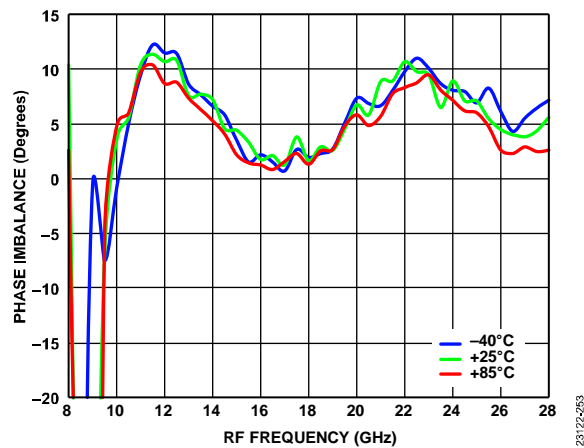

Figure 153. Phase Imbalance vs. RF Frequency at Various Temperatures, LO Drive = 18 dBm, IF = 2500 MHz

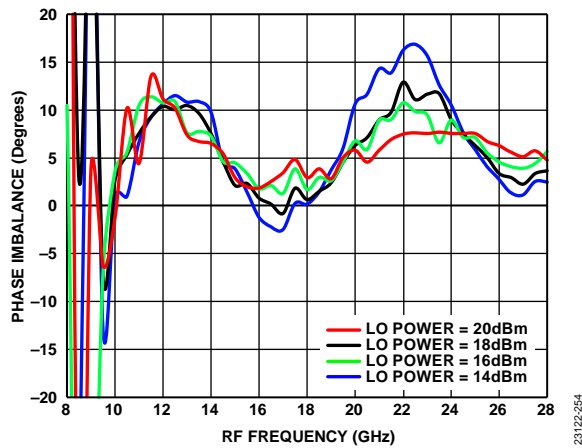

Figure 154. Phase Imbalance vs. RF Frequency at Various LO Drives, IF = 2500 MHz, T_A = 25°C

SPURIOUS AND HARMONICS PERFORMANCE

LO Harmonics Isolation

LO power = 18 dBm, T_A = 25°C, and all values are in dBc below the input LO level measured at the RF port. N/A means not applicable.

Table 5. N × LO Spur at RF Output

LO Frequency (GHz)	N × LO Spur at RF Port			
	1	2	3	4
6	39	48	57	58
8	39	55	53	71
10	46	68	64	81
12	48	61	76	>95
14	44	57	>95	N/A
16	39	70	>95	N/A
18	40	78	N/A	N/A
20	39	93	N/A	N/A
22	41	>95	N/A	N/A
24	42	>95	N/A	N/A
26	44	N/A	N/A	N/A

Downconverter M × N Spurious Outputs

Mixer spurious products are measured in dBc from the IF output power level, unless otherwise specified. Spur values are (M × RF) – (N × LO). N/A means not applicable.

IF = 100 MHz, RF = 15.9 GHz, LO = 16 GHz,
RF power = –10 dBm, LO power = +18 dBm, and T_A = 25°C.

M × RF	N × LO					
	0	1	2	3	4	5
0	0	–8	+18	+36	N/A	N/A
1	+6	0	+24	+33	+38	N/A
2	+62	+68	+73	+73	+52	+37
3	+40	+63	+69	+82	+74	+53
4	N/A	+39	+62	+72	+84	+75
5	N/A	N/A	+39	+62	+71	+85

IF = 2500 MHz, RF = 13.5 GHz, LO = 16 GHz,
RF power = –10 dBm, LO power = +18 dBm, and T_A = 25°C.

M × RF	N × LO					
	0	1	2	3	4	5
0	0	–14	+13	+32	N/A	N/A
1	–2	0	+20	+50	N/A	N/A
2	+52	+54	+81	+58	+47	N/A
3	+50	+57	+76	+79	+54	+47
4	N/A	+46	+57	+80	+70	+45
5	N/A	N/A	+42	+57	+86	+71

IF = 5000 MHz, RF = 11 GHz, LO = 16 GHz,
RF power = –10 dBm, LO power = +18 dBm, and T_A = 25°C.

M × RF	N × LO					
	0	1	2	3	4	5
0	0	–16	+11	+30	N/A	N/A
1	–7	0	+15	+44	N/A	N/A
2	+50	+76	+56	+42	+30	N/A
3	+51	+68	+82	+66	+52	+34
4	+43	+51	+69	+79	+57	+37
5	N/A	+43	+54	+81	+73	+57

Upconverter M × N Spurious Outputs

Mixer spurious products are measured in dBc from the RF output power level, unless otherwise specified. Spur values are (M × IF) – (N × LO). N/A means not applicable.

IF = 100 MHz, RF = 15.9 GHz, LO = 16 GHz,
RF power = –10 dBm, LO power = +18 dBm, and T_A = 25°C.

M × IF	N × LO					
	0	1	2	3	4	5
0	0	4	40	37	N/A	N/A
1	66	0	34	40	N/A	N/A
2	79	54	71	60	N/A	N/A
3	83	57	72	60	N/A	N/A
4	83	84	76	62	N/A	N/A
5	85	85	76	59	N/A	N/A

IF = 2500 MHz, RF = 13.5 GHz, LO = 16 GHz,
RF power = –10 dBm, LO power = +18 dBm, and T_A = 25°C.

M × IF	N × LO					
	0	1	2	3	4	5
0	0	1	36	33	N/A	N/A
1	17	0	43	56	N/A	N/A
2	72	65	60	65	N/A	N/A
3	72	80	78	67	N/A	N/A
4	83	79	78	68	N/A	N/A
5	83	88	79	68	N/A	N/A

IF = 5000 MHz, RF = 11 GHz, LO = 16 GHz,
RF power = –10 dBm, LO power = +18 dBm, and T_A = 25°C.

M × IF	N × LO					
	0	1	2	3	4	5
0	0	–2	+33	+30	N/A	N/A
1	+3	0	+18	+38	N/A	N/A
2	+64	+66	+61	+64	N/A	N/A
3	+76	+84	+78	+68	+59	N/A
4	+76	+79	+80	+72	+64	N/A
5	+73	+81	+81	+73	+63	N/A

THEORY OF OPERATION

The HMC8191CHIPS is a passive, wideband, I/Q, MMIC mixer that can be used either as an image rejection mixer for receiver operations or as a single sideband upconverter for transmitter operations. With an RF and LO range of 6 GHz to 26.5 GHz, and an IF bandwidth of dc to 5 GHz, the HMC8191CHIPS is ideal for applications requiring a wide frequency range, excellent RF performance, a simple design with fewer components, and a small PCB footprint. A single HMC8191CHIPS can replace multiple narrow-band mixers in a design.

The inherent I/Q architecture of the HMC8191CHIPS offers excellent image rejection of 29.5 dBc typical, eliminating the need for expensive filtering for unwanted sidebands. The double balanced architecture of the mixer provides excellent LO to RF isolation of 43.5 dB typical, and LO to IF isolation of 42 dB

typical. The mixer also reduces the effect of LO leakage to ensure signal integrity.

As a passive mixer, the HMC8191CHIPS does not require any dc power sources. The device offers a lower noise figure compared to an active mixer, ensuring superior dynamic range for high performance and precision applications.

The HMC8191CHIPS is fabricated on a GaAs, MESFET process and uses Analog Devices mixer cells and a 90° hybrid. The HMC8191CHIPS is a 7-pad bare die and operates over a -40°C to +85°C temperature range.

An external 90° hybrid is required for both upconversion and downconversion. See the Applications Information section for details on interfacing with an external 90° hybrid.

APPLICATIONS INFORMATION

Figure 155 shows the typical application circuit for the HMC8191CHIPS. To select the appropriate sideband, an external 90° hybrid is needed. For applications that do not require operation to dc, use an off chip dc blocking capacitor. For applications that require suppression of the LO signal at the output, use a bias tee or an RF feed as shown in Figure 155. Ensure that the source or sink current used for LO suppression is less than 3 mA for each IFx port to prevent damage to the device. The common-mode voltage for each IFx port is 0 V.

To select the upper sideband when using the HMC8191CHIPS as an upconverter, connect the IF1 pad to the 90° port of the hybrid and connect the IF2 pad to the 0° port of the hybrid. To select

the lower sideband, connect the IF1 pad to the 0° port of the hybrid and the IF2 pad to the 90° port of the hybrid. The input is from the sum port of the hybrid, and the difference port is 50 Ω terminated.

To select the upper sideband (low-side LO) when using the HMC8191CHIPS as a downconverter, connect the IF1 pad to the 0° port of the hybrid and connect the IF2 pad to the 90° port of the hybrid. To select the lower sideband (high-side LO), connect the IF1 pad to the 90° port of the hybrid and the IF2 pad to the 0° port of the hybrid. The output is from the sum port of the hybrid, and the difference port is 50 Ω terminated.

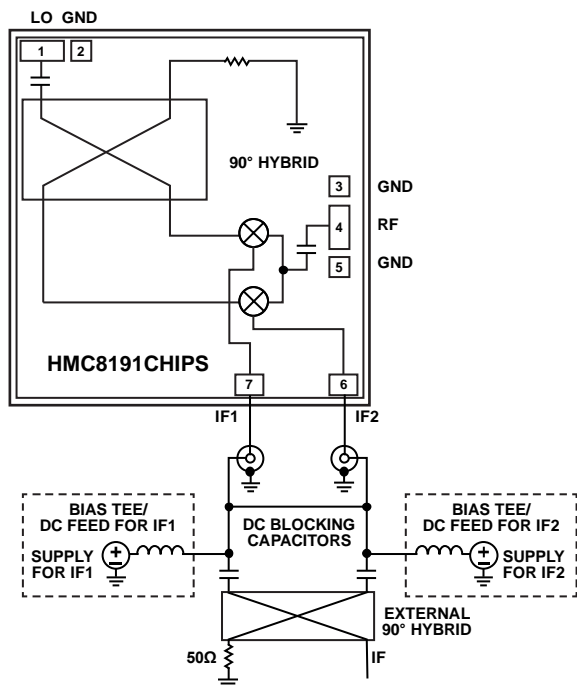

Figure 155. Typical Application Circuit