



28 Gbps, 1:4 DEMUX w/ PROGRAMMABLE OUTPUT VOLTAGE

Typical Applications

The HMC855LC5 is ideal for:

- SONET OC-192
- Broadband Test & Measurement
- Serial Data Transmission up to 28 Gbps
- FPGA Interfacing

Features

- Differential & Single-Ended Operation
- Half Rate Clock Input
- Quarter Rate Reference Clock Output
- Fast Rise and Fall Times: 22 ps
- Low Power Consumption: 644 mW typ.
- Programmable Differential Output Voltage Swing: 450 - 1144 mV
- Single Supply: -3.3V
- 32 Lead Ceramic 5x5 mm SMT Package: 25 mm²

Functional Diagram

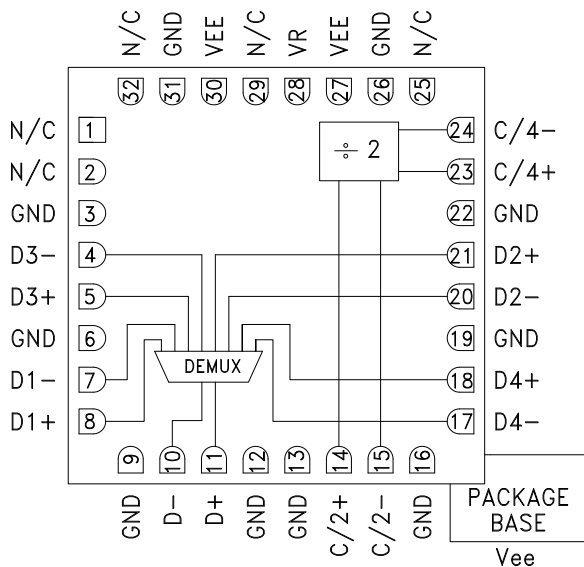

General Description

The HMC855LC5 is a 1:4 demultiplexer designed for data deserialization up to 28 Gbps. The device uses both rising and falling edges of the half-rate clock to sample the input data in sequence, D0-D3 and latches the data onto the differential outputs. A quarter-rate clock output generated on chip can be used to clock the data into other devices. The demux is DC coupled supporting broadband operation.

All clock and data inputs to the HMC855LC5 are CML and terminated on-chip with 50 Ohms to the positive supply, GND, and may be DC or AC coupled. The differential outputs are source terminated to 50 Ohms and may also be AC or DC coupled. Outputs can be connected directly to a 50 Ohm ground terminated system, or drive devices with CML logic input. The HMC855LC5 also features an output level control pin, VR, which allows for loss compensation or signal level optimization. The HMC855LC5 operates from a single -3.3V supply and is available in RoHS compliant 5x5 mm SMT package.

Electrical Specifications, $T_A = +25^\circ\text{C}$, $V_{ee} = -3.3\text{V}$, $VR = 0\text{V}$

| Parameter | Conditions | Min. | Typ. | Max | Units |
|-------------------------------|-------------------------|------|------|------|-------|
| Power Supply Voltage | | -3.6 | -3.3 | -3.0 | V |
| Power Supply Current | | | 195 | | mA |
| Maximum Data Rate | | | 28 | | Gbps |
| Maximum Clock Rate, Half Rate | | | 14 | | GHz |
| Input Voltage Range, CML | | -1.5 | | 0.5 | V |
| Input Differential Voltage | | 100 | | 2000 | mV |
| Output Rise / Fall Time | Differential, 20% - 80% | | 22 | | ps |
| Input Return Loss | Frequency <28 GHz | | 10 | | dB |

Information furnished by Analog Devices is believed to be accurate and reliable. However, no responsibility is assumed by Analog Devices for its use, nor for any infringements of patents or other rights of third parties that may result from its use. Specifications subject to change without notice. No license is granted by implication or otherwise under any patent or patent rights of Analog Devices. Trademarks and registered trademarks are the property of their respective owners.

For price, delivery, and to place orders: Analog Devices, Inc., One Technology Way, P.O. Box 9106, Norwood, MA 02062-9106
Phone: 781-329-4700 • Order online at www.analog.com
Application Support: Phone: 1-800-ANALOG-D



**28 Gbps, 1:4 DEMUX
w/ PROGRAMMABLE OUTPUT VOLTAGE**

Electrical Specifications (continued)

| Parameter | Conditions | Min. | Typ. | Max | Units |
|--|----------------------------|------|------|-----|-------|
| Output Amplitude | Single-Ended, peak-to-peak | | 500 | | mVp-p |
| | Differential, peak-to-peak | | 1000 | | mVp-p |
| Output High Voltage | | | 0 | | mV |
| Output Low Voltage | | | -500 | | mV |
| Output Return Loss | Frequency <22 GHz | | 10 | | dB |
| Propagation Delay Clock to Data, T _{pd} | | | 149 | | ps |
| Propagation Delay Clock to Output Clock, T _{pd} | | | 142 | | ps |
| Set Up Time, t _s | | | 16 | | ps |
| Hold Time, t _h | | | 3 | | ps |

DC Current vs. Supply Voltage [1] [2]

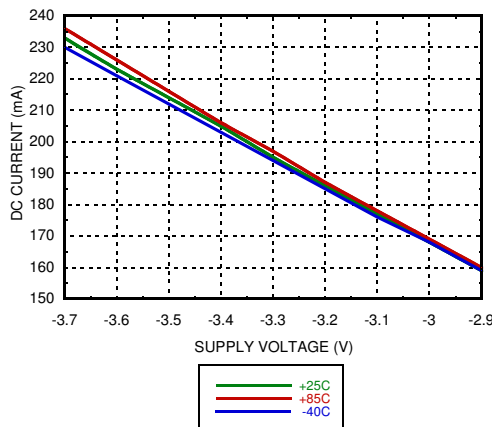

Output Differential vs. Supply Voltage [1] [2]

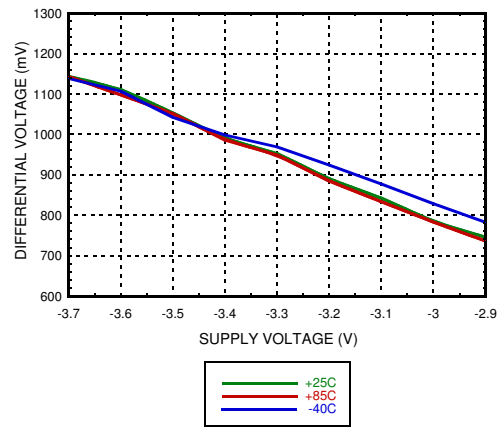

Output Differential vs. VR [2][3]

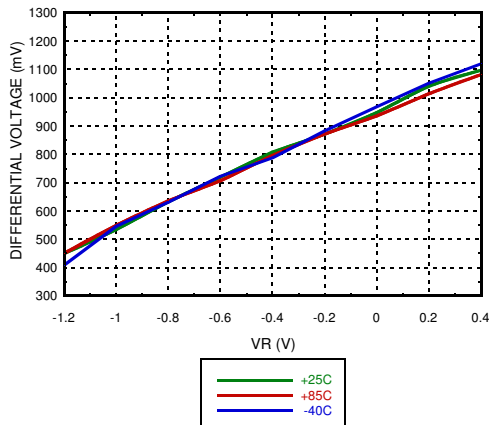

DC Current vs. VR [2][3]

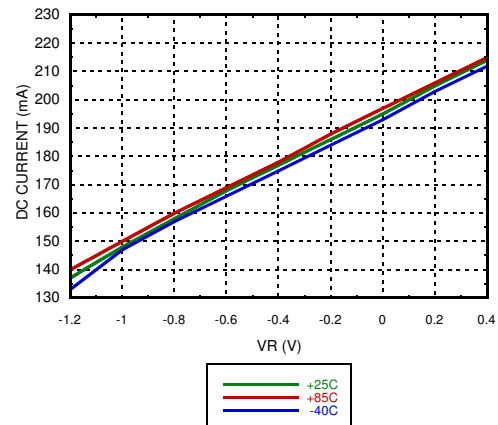

[1] VR = 0.0V

[2] Frequency = 28 Gbps

[3] Vee = -3.3V

Information furnished by Analog Devices is believed to be accurate and reliable. However, no responsibility is assumed by Analog Devices for its use, nor for any infringements of patents or other rights of third parties that may result from its use. Specifications subject to change without notice. No license is granted by implication or otherwise under any patent or patent rights of Analog Devices. Trademarks and registered trademarks are the property of their respective owners.

For price, delivery, and to place orders: Analog Devices, Inc., One Technology Way, P.O. Box 9106, Norwood, MA 02062-9106 Phone: 781-329-4700 • Order online at www.analog.com Application Support: Phone: 1-800-ANALOG-D



**28 Gbps, 1:4 DEMUX
w/ PROGRAMMABLE OUTPUT VOLTAGE**

Rise / Fall Time vs. Supply Voltage [1][2]

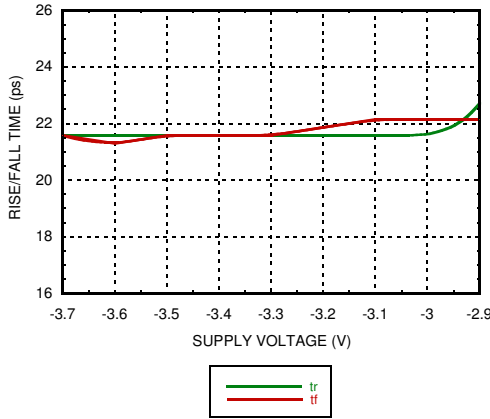

Rise / Fall Time vs. VR [2][4]

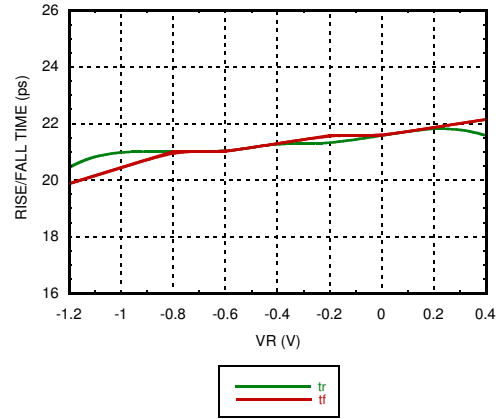

Data Input Return Loss vs. Frequency [1][3][4]

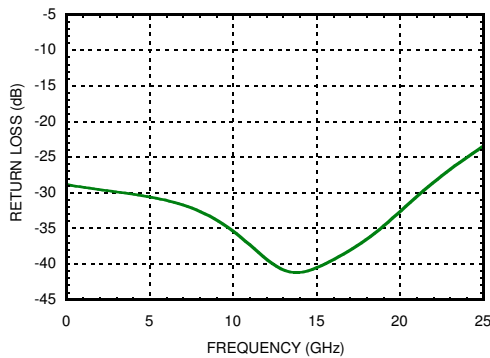

Data Output Return Loss vs. Frequency [1][3][4]

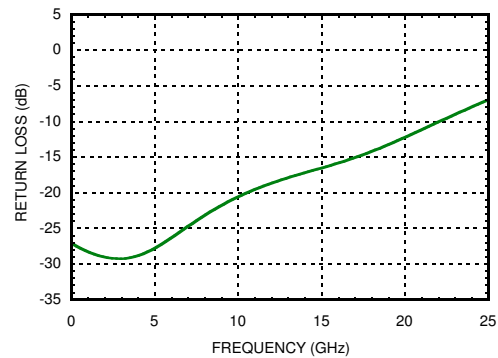

Clock Input Return Loss vs. Frequency [1][3][4]

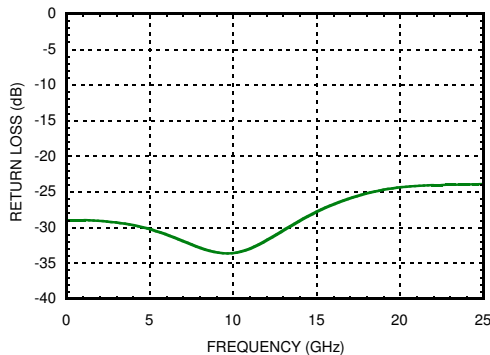

Clock Output Return Loss vs. Frequency [1][3][4]

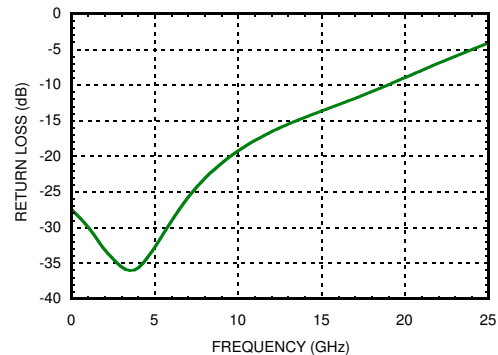

[1] VR = 0.0V [2] Frequency = 28 Gbps [3] Device measured on evaluation board with gating [4] Vee = -3.3V

Information furnished by Analog Devices is believed to be accurate and reliable. However, no responsibility is assumed by Analog Devices for its use, nor for any infringements of patents or other rights of third parties that may result from its use. Specifications subject to change without notice. No license is granted by implication or otherwise under any patent or patent rights of Analog Devices. Trademarks and registered trademarks are the property of their respective owners.

For price, delivery, and to place orders: Analog Devices, Inc., One Technology Way, P.O. Box 9106, Norwood, MA 02062-9106 Phone: 781-329-4700 • Order online at www.analog.com Application Support: Phone: 1-800-ANALOG-D



**28 Gbps, 1:4 DEMUX
w/ PROGRAMMABLE OUTPUT VOLTAGE**

Eye Diagram @ 28 Gbps

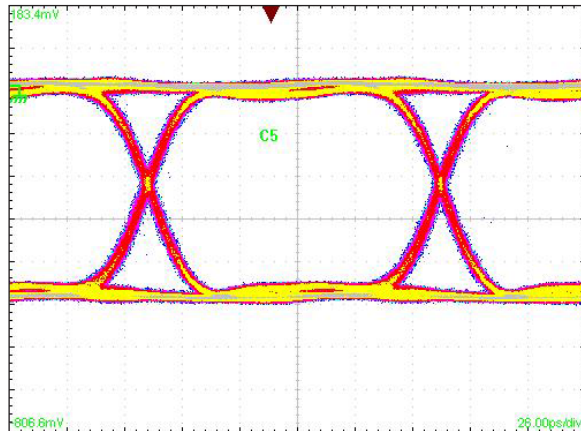

Test Conditions:

Differential 400 mV data input and 300 mV clock input. Pattern generated with a $2^{15}-1$ PN 28 Gbps PRBS pattern. Resulting in a 7 Gbps output measured using a Tektronix CSA 8000

Timing Diagram

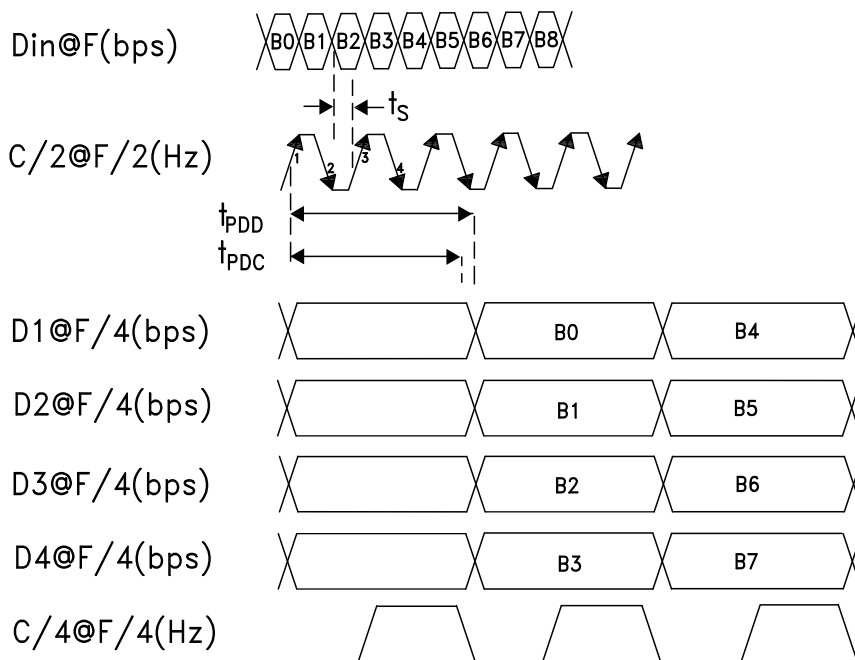



28 Gbps, 1:4 DEMUX w/ PROGRAMMABLE OUTPUT VOLTAGE

Absolute Maximum Ratings

| | |
|--|-----------------|
| Power Supply Voltage (Vee) | -3.75V to +0.5V |
| Input Signals | -2V to +0.5V |
| Output Signals | -1.5V to +0.5V |
| Junction Temperature | 125 °C |
| Continuous Pdiss (T = 85 °C) (derate 33 mW/°C above 85 °C) | 1.33 W |
| Thermal Resistance (R _{th j-p}) Worse case device to package paddle | 30 °C/W |
| Storage Temperature | -65°C to +150°C |
| Operating Temperature | -40°C to +85°C |
| ESD Sensitivity (HBM) | Class 1C |



ELECTROSTATIC SENSITIVE DEVICE
OBSERVE HANDLING PRECAUTIONS

Outline Drawing

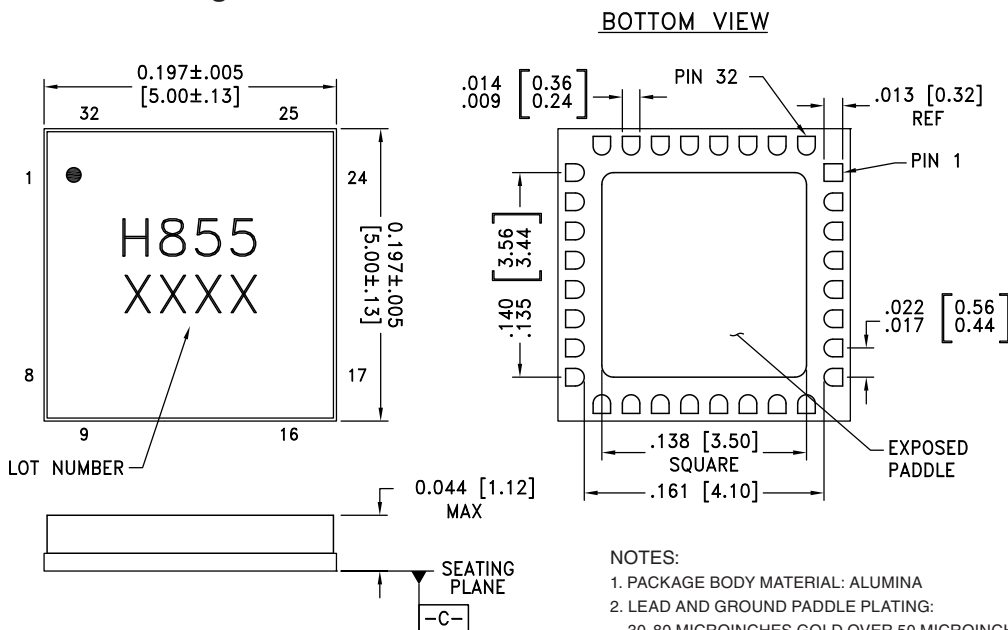

NOTES:

1. PACKAGE BODY MATERIAL: ALUMINA
2. LEAD AND GROUND PADDLE PLATING:
30-80 MICROINCHES GOLD OVER 50 MICROINCHES MINIMUM NICKEL.
3. DIMENSIONS ARE IN INCHES [MILLIMETERS].
4. LEAD SPACING TOLERANCE IS NON-CUMULATIVE.
5. PACKAGE WARP SHALL NOT EXCEED 0.05mm DATUM -C-
6. ALL GROUND LEADS MUST BE SOLDERED TO PCB RF GROUND.
7. PADDLE MUST BE SOLDERED TO Vee.

Package Information

| Part Number | Package Body Material | Lead Finish | MSL Rating | Package Marking ^[2] |
|-------------|-----------------------|------------------|---------------------|--------------------------------|
| HMC855LC5 | Alumina, White | Gold over Nickel | MSL3 ^[1] | H855 XXXX |

[1] Max peak reflow temperature of 260 °C

[2] 4-Digit lot number XXXX



28 Gbps, 1:4 DEMUX w/ PROGRAMMABLE OUTPUT VOLTAGE

Pin Descriptions

| Pin Number | Function | Description | Interface Schematic |
|-------------------------------------|--|---|---------------------|
| 1, 2, 25, 29, 32 | N/C | No connection necessary. These pins may be connected to RF/DC ground without affecting performance. | |
| 3, 6, 9, 12, 13, 16, 19, 22, 26, 31 | GND | These pins must be connected to a high quality RF/DC ground. | |
| 4, 5, 7, 8, 17, 18, 20, 21 | D3-, D3+ D1-, D1+ D4-, D4+ D2-, D2+ | Differential Data Outputs: Current Mode Logic(CML) referenced to positive supply | |
| 10, 11 | D-, D+ | Differential Data Inputs: Current Mode Logic (CML) referenced to positive supply | |
| 14, 15 | C/2+, C/2- | Differential Half-Rate Clock Inputs: Current Mode Logic (CML) referenced to positive supply | |
| 23, 24 | C/4+, C/4- | Differential Quarter-Rate Clock Outputs: Current Mode Logic(CML) referenced to positive supply | |
| 27, 30, Package Base | Vee | These pins and the exposed paddle must be connected to the negative voltage supply. | |
| 28 | VR | Output level control. Output level may be increased or decreased by applying a voltage to VR per "Output Differential vs. VR" plot. | |



**28 Gbps, 1:4 DEMUX
w/ PROGRAMMABLE OUTPUT VOLTAGE**

Evaluation PCB

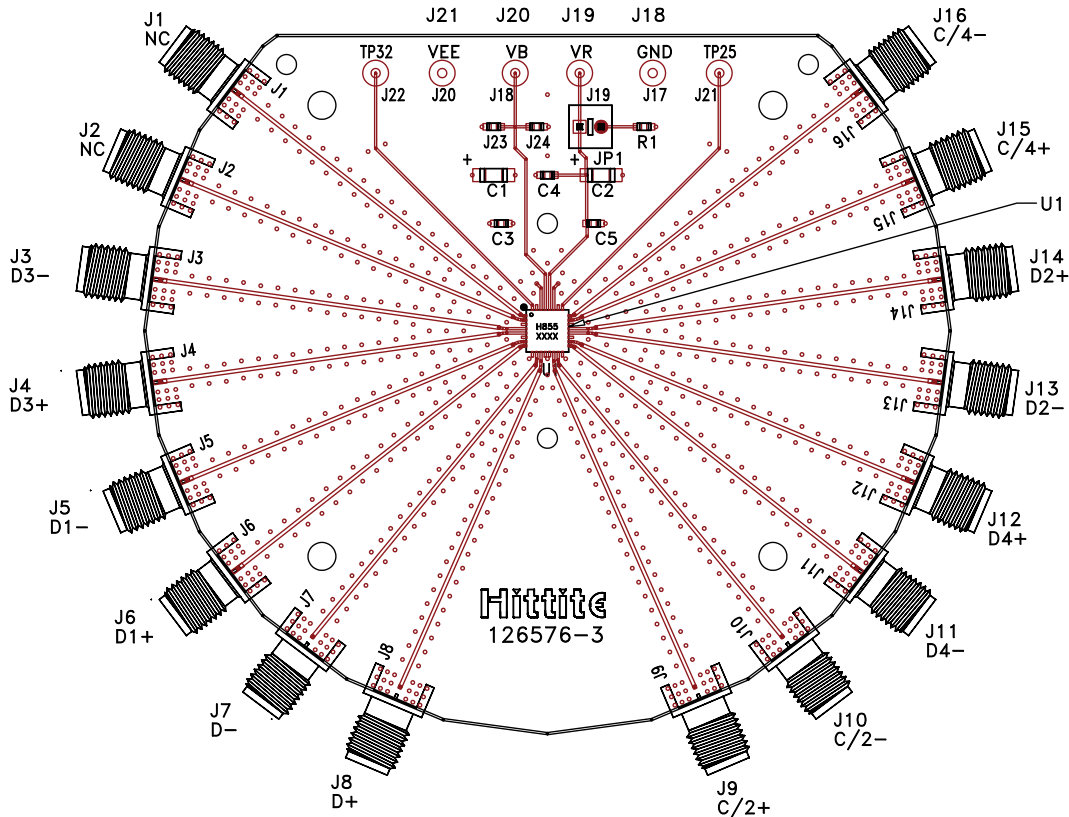

List of Materials for Evaluation PCB 126578 [1]

| Item | Description |
|--------------------|------------------------------|
| J7 - J10 | PCB Mount K RF Connectors |
| J3 - J6, J11 - J16 | PCB Mount SMA RF Connectors |
| J18 - J21 | DC Pin |
| JP1 | 2 Position Header with Shunt |
| C1, C2 | 4.7 µF Capacitor, Tantalum |
| C3 - C5 | 100 pF Capacitor, 0402 Pkg. |
| R1 | 10 Ohm Resistor, 0603 Pkg. |
| U1 | HMC855LC5 28 Gbps 1:4 Demux |
| PCB [2] | 126576 Evaluation Board |

[1] Reference this number when ordering complete evaluation PCB

[2] Circuit Board Material: Arlon 25FR or Rogers 4350

The circuit board used in the application should use RF circuit design techniques. Signal lines should have 50 Ohm impedance while the package ground leads should be connected directly to the ground plane similar to that shown. The exposed metal package base must be connected to Vee. A sufficient number of via holes should be used to connect the top and bottom ground planes. The evaluation circuit board shown is available from Hittite upon request. Install jumper on JP1 to short VR to GND for normal operation.

Information furnished by Analog Devices is believed to be accurate and reliable. However, no responsibility is assumed by Analog Devices for its use, nor for any infringements of patents or other rights of third parties that may result from its use. Specifications subject to change without notice. No license is granted by implication or otherwise under any patent or patent rights of Analog Devices. Trademarks and registered trademarks are the property of their respective owners.

For price, delivery, and to place orders: Analog Devices, Inc., One Technology Way, P.O. Box 9106, Norwood, MA 02062-9106 Phone: 781-329-4700 • Order online at www.analog.com Application Support: Phone: 1-800-ANALOG-D