

Typical Applications

The HMC959LC3 is ideal for:

- High Speed Frequency Divider (up to 26 GHz)
- Broadband Test & Measurement
- Clock Synthesis
- Phase Locked Loops

Features

- Supports Clock Frequencies up to 26 GHz
- Differential or Single-Ended Operation
- Fast Rise and Fall Times: 19 ps
- Low Power Consumption: 281 mW typ.
- Programmable Differential Output Voltage Swing: 800 - 1800 mVp-p
- Propagation Delay: 121 ps
- Single Supply: -3.3 V
- 16 Lead Ceramic 3x3 mm SMT Package: 9 mm²

Functional Diagram

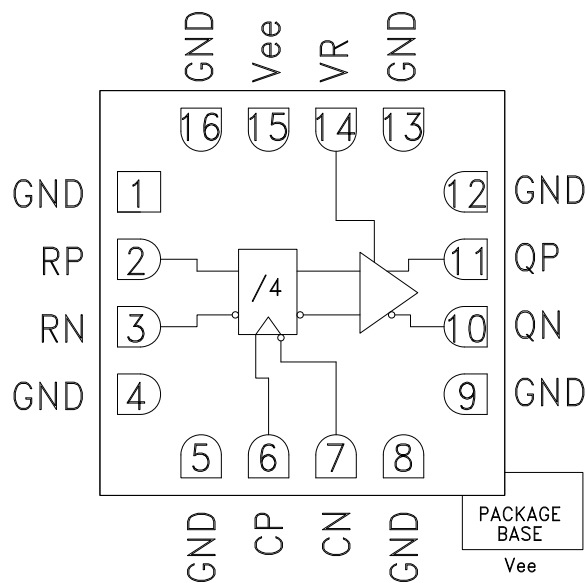

General Description

The HMC959LC3 is a Divide-by-4 w/Reset designed to support clock frequencies as high as 26 GHz. During normal operation, with the reset pin not asserted, the output toggles from its prior state on the positive edge of the clock. This results in a divide-by-four function of the clock input. Asserting the reset pin forces the Q output low regardless of the clock edge state (asynchronous reset assertion). Reversing the clock inputs allows for negative-edge triggered applications.

All differential inputs to the HMC959LC3 are CML and terminated on-chip with 50 Ohms to the positive supply, GND, and may be DC or AC coupled. Outputs can be connected directly to a 50 Ohm ground-terminated system or drive devices with CML logic input. The HMC959LC3 also features an output level control pin, VR, which allows for loss compensation or signal level optimization. The HMC959LC3 operates from a single -3.3 V supply and is available in ROHS-compliant 3x3 mm SMT package.

Electrical Specifications, $T_A = +25\text{ }^\circ\text{C}$ $V_{ee} = -3.3\text{ V}$, $VR = 0\text{ V}$

| Parameter | Conditions | Min. | Typ. | Max | Units |
|--------------------------|----------------------------|------|------|------|-------|
| Power Supply Voltage | | -3.6 | -3.3 | -3.0 | V |
| Power Supply Current | | | 85 | | mA |
| Maximum Clock Rate | | | 26 | | GHz |
| Input Voltage Range | | -1.5 | | 0.5 | V |
| Input Differential Range | | 0.1 | | 2.0 | Vp-p |
| Input Return Loss | Frequency <19 GHz | | 10 | | dB |
| Output Amplitude | Single-Ended, peak-to-peak | | 800 | | mVp-p |
| | Differential, peak-to-peak | | 1600 | | mVp-p |
| Output High Voltage | | | -15 | | mV |
| Output Low Voltage | | | -815 | | mV |



DIVIDE-BY-4 w/ RESET & PROGRAMMABLE OUTPUT VOLTAGE, 26 GHz

Electrical Specifications (continued)

| Parameter | Conditions | Min. | Typ. | Max | Units |
|-----------------------------------|-------------------------|------|------|------|--------|
| Output Rise / Fall Time | Differential, 20% - 80% | | 19 | | ps |
| Output Return Loss | Frequency <20 GHz | | 10 | | dB |
| Random Jitter Jr | rms ^[1] | | 0.09 | 0.13 | ps rms |
| Propagation Delay Clock to Q, td | | | 121 | | ps |
| Propagation Delay Reset to Q, tdr | | | 132 | | ps |
| VR Pin Current | VR = 0.0 V | | 3 | | mA |
| VR Pin Current | VR = 0.4 V | | | 4.25 | mA |

[1] Added jitter calculated by de-embedding the clock source jitter.

DC Current vs. Supply Voltage ^{[1][2]}



DC Current vs. VR ^{[2][3]}

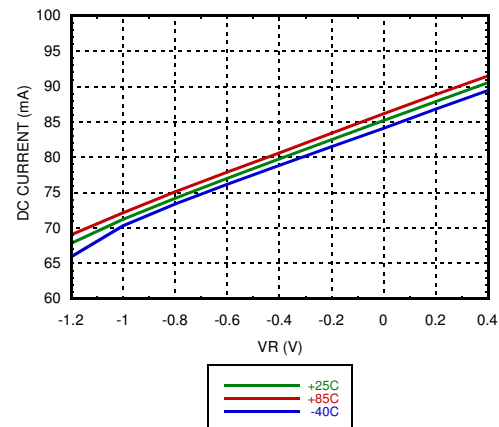

Output Differential Voltage vs. Supply Voltage ^{[1][2]}

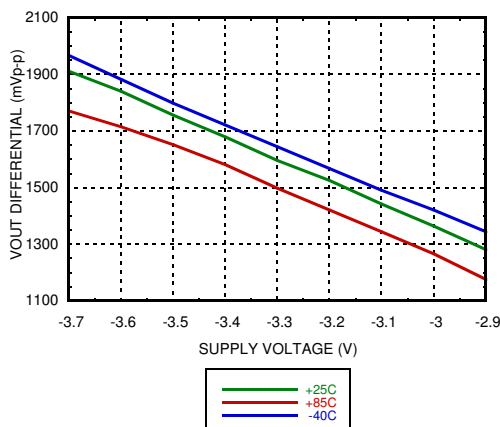

Output Differential Voltage vs. VR ^{[2][3]}

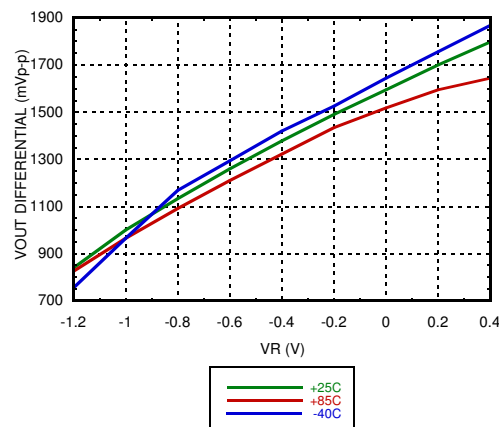

[1] VR = 0.0 V

[2] Frequency = 28 GHz

[3] Vee = -3.3 V



DIVIDE-BY-4 w/ RESET & PROGRAMMABLE OUTPUT VOLTAGE, 26 GHz

HIGH SPEED DIGITAL LOGIC - SMT

Rise / Fall Time vs. Supply Voltage [1][2]

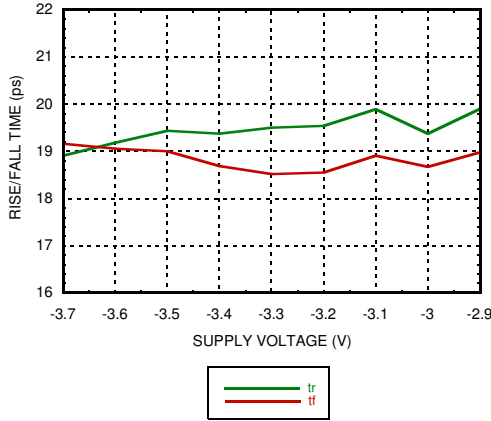

Rise / Fall Time vs. VR [2][3]

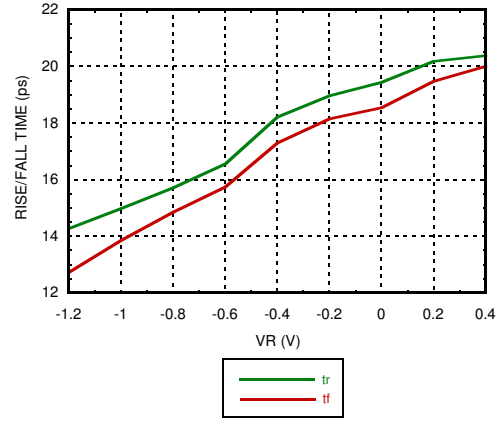

Reset Input Return Loss [1][2][3][4]

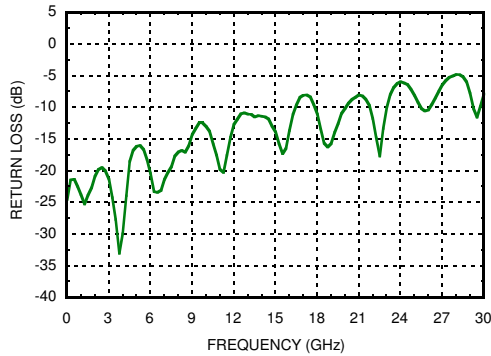

Clock Input Return Loss [1][2][3][4]

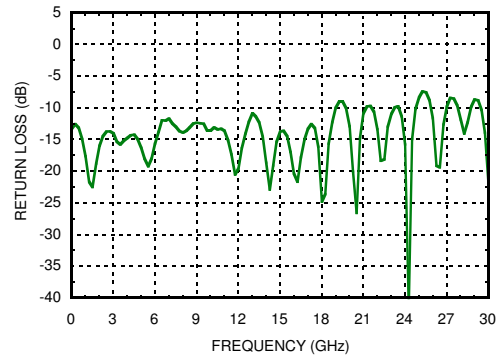

Clock Output Return Loss [1][2][3][4]

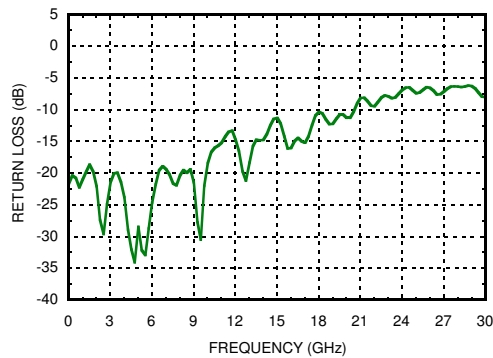

[1] VR = 0.0V

[2] Frequency = 28 GHz

[3] Vee = -3.3 V

[4] Device measured on evaluation board with gating

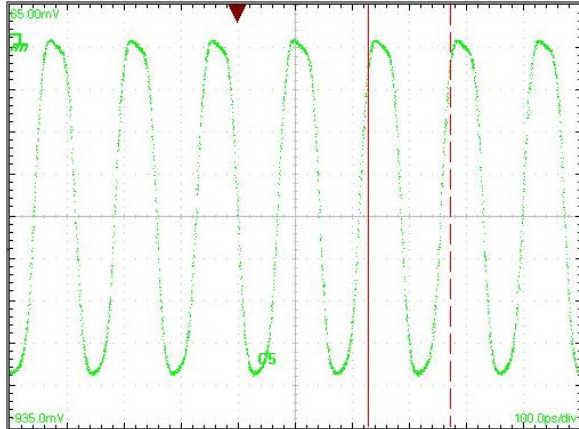
**DIVIDE-BY-4 w/ RESET &
PROGRAMMABLE OUTPUT VOLTAGE, 26 GHz**
Output Waveform

[1] Test Conditions:
Waveform generated with a CW signal source input at 28 GHz.
Diagram data presented on a Tektronix CSA 8000.

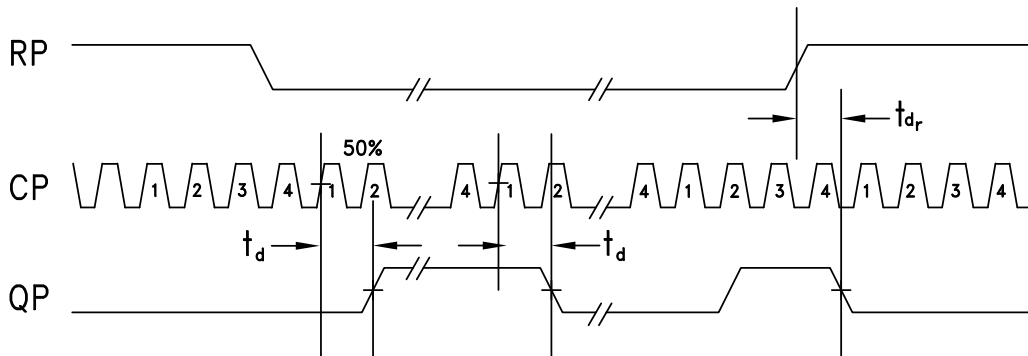
Timing Diagram

t_d = propagation delay, CK (clock) to Q
 t_{dr} = propagation delay, R (reset) to Q.



DIVIDE-BY-4 w/ RESET & PROGRAMMABLE OUTPUT VOLTAGE, 26 GHz

Absolute Maximum Ratings

| | |
|--|-------------------|
| Power Supply Voltage (Vee) | -3.75 V to +0.5 V |
| Input Signals | -2 V to +0.5 V |
| Output Signals | -1.5 V to +1 V |
| Continuous Pdiss (T = 85 °C) (derate 17 mW/°C above 85 °C) | 0.68 W |
| Thermal Resistance (R _{th(j-p)}) Worst Case Junction to Package Paddle | 59 °C/W |
| Storage Temperature | -65 °C to +150 °C |
| Operating Temperature | -40 °C to +85 °C |
| Maximum Junction Temperature | 125 °C |
| ESD Sensitivity (HBM) | Class 1C |



ELECTROSTATIC SENSITIVE DEVICE
OBSERVE HANDLING PRECAUTIONS

Outline Drawing

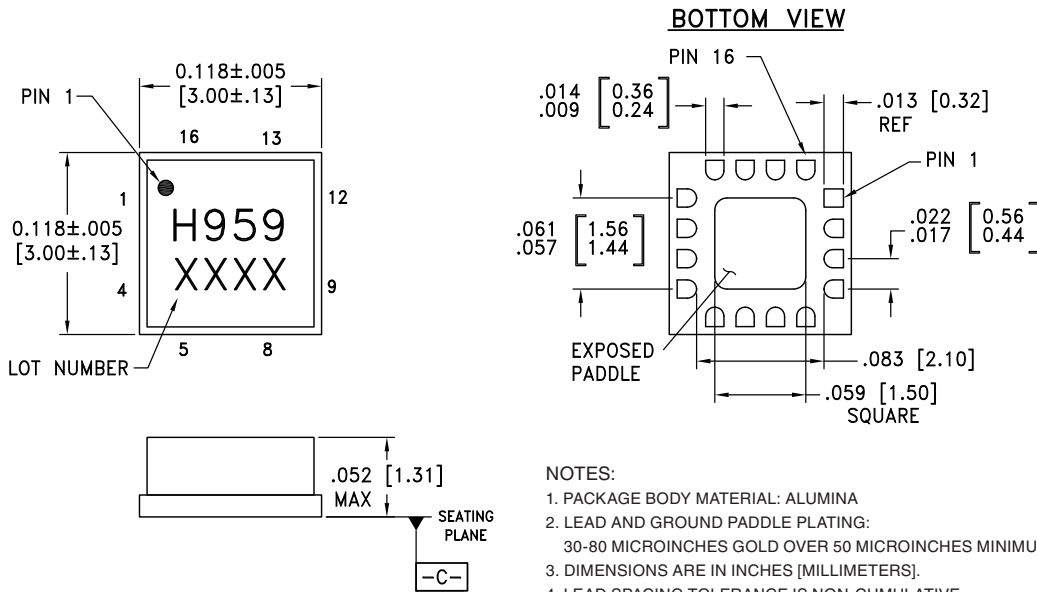

NOTES:

1. PACKAGE BODY MATERIAL: ALUMINA
2. LEAD AND GROUND PADDLE PLATING:
30-80 MICROINCHES GOLD OVER 50 MICROINCHES MINIMUM NICKEL.
3. DIMENSIONS ARE IN INCHES [MILLIMETERS].
4. LEAD SPACING TOLERANCE IS NON-CUMULATIVE.
5. PACKAGE WARP SHALL NOT EXCEED 0.05mm DATUM -C-
6. ALL GROUND LEADS MUST BE SOLDERED TO PCB RF GROUND.
7. PADDLE MUST BE SOLDERED TO Vee.

Package Information

| Part Number | Package Body Material | Lead Finish | MSL Rating | Package Marking ^[2] |
|-------------|-----------------------|------------------|---------------------|--------------------------------|
| HMC959LC3 | Alumina, White | Gold over Nickel | MSL3 ^[1] | H959 XXXX |



[1] Max peak reflow temperature of 260 °C

[2] 4-Digit lot number XXXX

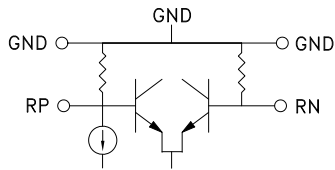
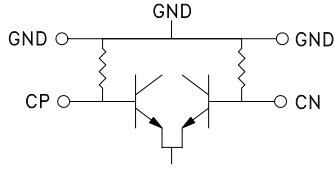
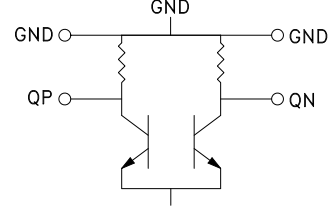

DIVIDE-BY-4 w/ RESET & PROGRAMMABLE OUTPUT VOLTAGE, 26 GHz

Pin Descriptions

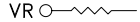
| Pin Number | Function | Description | Interface Schematic |
|-------------------|----------|---|---|
| 1, 4, 5, 8, 9, 12 | GND | Signal Grounds |  |
| 2, 3 | RP, RN | Differential Reset Inputs: Current Mode Logic (CML) referenced to positive supply. |  |
| 6, 7 | CP, CN | Differential Clock Inputs: Current Mode Logic (CML) referenced to positive supply. |  |
| 10, 11 | QN, QP | Differential Clock Outputs: Current Mode Logic (CML) referenced to positive supply. |  |
| 13, 16 | GND | Supply Ground |  |
| 14 | VR | Output level control. Output level may be increased or decreased by applying a voltage to VR per "Output Differential vs. VR" plot. |  |
| 15, Package Base | Vee | This pin and the exposed paddle must be connected to the negative voltage supply. | |

DIVIDE-BY-4 w/ RESET & PROGRAMMABLE OUTPUT VOLTAGE, 26 GHz
Evaluation PCB

List of Materials for Evaluation PCB 123585 [1]

| Item | Description |
|----------------|---------------------------------|
| J1, J2, J5, J6 | PCB Mount SMA RF Connectors |
| J3, J4 | PCB Mount 2.92 mm RF Connectors |
| J7 - J9 | DC Pin |
| JP1 | 2-Position Header with Shunt |
| C1 - C2 | 100 pF Capacitor, 0402 Pkg. |
| C3 - C4 | 4.7 μ F Capacitor, Tantalum |
| R1 | 10 Ohm Resistor, 0603 Pkg. |
| U1 | HMC959LC3 Clock Divider |
| PCB [2] | 118775 Evaluation Board |

[1] Reference this number when ordering complete evaluation PCB

[2] Circuit Board Material: Arlon 25FR or Rogers 4350

The circuit board used in the application should use RF circuit design techniques. Signal lines should have 50 Ohm impedance while the package ground leads should be connected directly to the ground plane similar to that shown. The exposed packaged base should be connected to Vee. A sufficient number of via holes should be used to connect the top and bottom ground planes. The evaluation circuit board shown is available from Hittite upon request. Install jumper on JP1 to short VR to GND for normal operation.