

FEATURES

- Conversion gain: 14 dB typical**
- Image rejection: 21 dBc typical at 20 GHz to 26.5 GHz**
- 2× LO to RF isolation: 45 dB typical at 20 GHz to 26.5 GHz**
- Noise figure: 2.5 dB typical at 20 GHz to 26.5 GHz**
- Input IP3: 1 dBm typical at 20 GHz to 26.5 GHz**
- LO drive range: 2 dBm to 6 dBm**
- 24-lead 4 mm × 4 mm LFCSP**

APPLICATIONS

- Point to point and point to multipoint radios**
- Military radar, electronic warfare (EW), and electronic intelligence (ELINT)**
- Satellite communications**

GENERAL DESCRIPTION

The HMC977 is a compact, gallium arsenide (GaAs), monolithic microwave integrated circuit (MMIC), inphase and quadrature (I/Q) downconverter in a leadless, RoHS compliant, surface-mount technology (SMT) package. This device provides a small signal conversion gain of 14 dB with a noise figure of 2.5 dB and 21 dBc of image rejection. The HMC977 utilizes a low noise amplifier (LNA) followed by an image reject mixer which is driven by an active 2× multiplier. The image reject

FUNCTIONAL BLOCK DIAGRAM

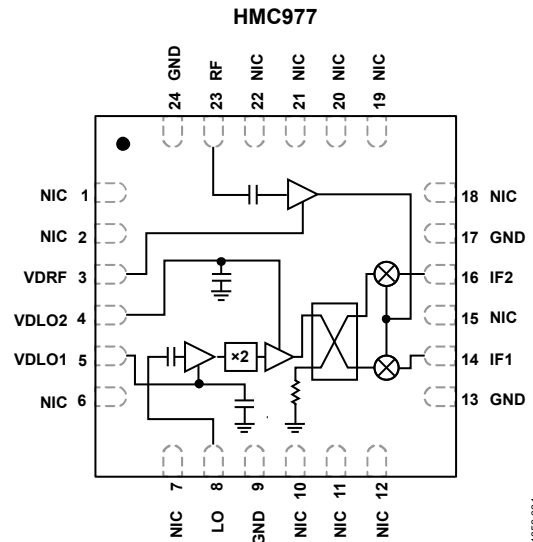

Figure 1.

mixer eliminates the need for a filter following the LNA and removes thermal noise at the image frequency. I and Q mixer outputs are provided and an external 90° hybrid is required to select the required sideband. The HMC977 is a much smaller alternative to hybrid style image reject mixer downconverter assemblies and is compatible with surface-mount manufacturing techniques.

TABLE OF CONTENTS

Features 1

Applications 1

Functional Block Diagram 1

General Description 1

Revision History 2

Specifications 3

 Electrical Specifications 3

Absolute Maximum Ratings 4

 Thermal Resistance 4

 ESD Caution 4

Pin Configuration and Function Descriptions 5

 Interface Schematics 6

Typical Performance Characteristics 7

 Data Taken as IRM with External 90° Hybrid at the IF Ports,
 IF = 1000 MHz, Upper Sideband 7

 Quadrature Channel Data Taken Without 90° Hybrid at the
 IF Ports, IF = 1000 MHz, Upper Sideband 9

 Data Taken as IRM with External 90° Hybrid at the IF Ports,
 IF = 1000 MHz, Lower Sideband 10

 Data Taken as IRM with External 90° Hybrid at the IF Ports,
 IF = 2000 MHz, Upper Sideband 11

 Data Taken as IRM with External 90° Hybrid at the IF Ports,
 IF = 2000 MHz, Lower Sideband 12

 Data Taken as IRM with External 90° Hybrid at the IF Ports,
 IF = 3300 MHz, Upper Sideband 13

 Data Taken as IRM with External 90° Hybrid at the IF Ports,
 IF = 3300 MHz, Lower Sideband 14

 Spurious Performance 15

Theory of Operation 16

Applications Information 17

 Evaluation PCB 18

 Layout 19

Outline Dimensions 20

 Ordering Guide 20

REVISION HISTORY

This Hittite Microwave Products data sheet has been reformatted to meet the styles and standards of Analog Devices, Inc.

11/2019—v02.0815 to Rev. D

Updated Format Universal

Changed HMC977LP4E to HMC977 Universal

Changes to Figure 1 1

Changes to the Electrical Specifications Section 3

Added Figure 2; Renumbered Sequentially 5

Changes to M × N Spurious Outputs,
IF = 1000 MHz Section 15

Added Theory of Operation Section 16

Added Applications Information Section 17

Changes to Figure 52 17

Change to Table 6 18

Added Figure 54 19

SPECIFICATIONS

ELECTRICAL SPECIFICATIONS

20 GHz to 26.5 GHz

$T_A = 25^\circ\text{C}$, IF = 1000 MHz, local oscillator (LO) = 6 dBm, drain bias voltage (V_{DD}) = VDLO1 = VDLO2 = VDREF = 3.5 V dc, upper sideband. All measurements performed as downconverter with upper sideband selected and external 90° hybrid at the IF ports, unless otherwise noted.

Table 1.

Parameter	Test Conditions/Comments	Min	Typ	Max	Units
FREQUENCY RANGE					
RF		20		26.5	GHz
LO		8.3		15	GHz
IF		DC		3.5	GHz
LO DRIVE RANGE		2		6	dBm
CONVERSION GAIN (AS IMAGE REJECT MIXER (IRM))		11	14		dB
NOISE FIGURE			2.5		dB
IMAGE REJECTION			21		dBc
INPUT POWER FOR 1 dB COMPRESSION (P1dB)			-8		dBm
ISOLATION					
2× LO to RF		35	45		dB
2× LO to IF			20		dB
INPUT THIRD-ORDER INTERCEPT (IP3)			1		dBm
AMPLITUDE BALANCE	Data taken without external 90° hybrid at the IF ports		0.3		dB
PHASE BALANCE	Data taken without external 90° hybrid at the IF ports		17		Degree
SUPPLY VOLTAGE	No power sequence is required	3.325	3.5	3.675	V
TOTAL SUPPLY CURRENT			170	210	mA

26.5 GHz to 28 GHz

$T_A = 25^\circ\text{C}$, IF = 1000 MHz, LO = 6 dBm, V_{DD} = VDLO1 = VDLO2 = VDREF = 3.5 V dc, upper sideband. All measurements performed as downconverter with upper sideband selected and external 90° hybrid at the IF ports, unless otherwise noted

Table 2.

Parameter	Test Conditions/Comments	Min	Typ	Max	Units
FREQUENCY RANGE					
RF		26.5		28	GHz
LO		11.5		15.7	GHz
IF		DC		3.5	GHz
LO DRIVE RANGE		2		6	dBm
CONVERSION GAIN (AS IRM)		11	14		dB
NOISE FIGURE			3		dB
IMAGE REJECTION			20		dBc
INPUT P1dB			-7		dBm
ISOLATION					
2× LO to RF		34	39		dB
2× LO to IF			30		dB
INPUT IP3			3		dBm
AMPLITUDE BALANCE	Data taken without external 90° hybrid at the IF ports		0.3		dB
PHASE BALANCE	Data taken without external 90° hybrid at the IF ports		12		Degree
SUPPLY VOLTAGE	No power sequence is required	3.325	3.5	3.675	V
TOTAL SUPPLY CURRENT			170	210	mA

ABSOLUTE MAXIMUM RATINGS

Table 3.

Parameter	Rating
RF Input Power	2 dBm
LO Drive	10 dBm
V _{DD}	5.0 V
Continuous Power Dissipation (P _{DISS}), T _A = 85°C (Derates 17.7 mW/°C Above 85°C) ¹	1.6 W
Temperature	
Junction (Channel), T _J	175°C
Peak Reflow (Moisture Sensitivity Level 1, MSL1 ²)	260°C
Storage Range	–65°C to +150°C
Operating Range	–40°C to +85°C
Electrostatic Discharge (ESD) Sensitivity	
Human Body Model (HBM)	Class 1A (250 V)

¹ P_{DISS} is a theoretical number calculated by $(T_J - 85^\circ\text{C})/\theta_{JC}$.

² Based on IPC/JEDEC J-STD-20 MSL classifications.

Stresses at or above those listed under Absolute Maximum Ratings may cause permanent damage to the product. This is a stress rating only; functional operation of the product at these or any other conditions above those indicated in the operational section of this specification is not implied. Operation beyond the maximum operating conditions for extended periods may affect product reliability.

THERMAL RESISTANCE

Thermal resistance is directly linked to printed circuit board (PCB) design and operating environment. Close attention to PCB thermal design is required.

θ_{JC} is the channel to case thermal resistance, channel to bottom of package.

Table 4. Thermal Resistance

Package Type ¹	θ_{JC}	Unit
HCP-24-2	56.3	°C/W

¹ Thermal impedance simulated values are based on a JEDEC 252P test board with 4 mm × 4 mm thermal vias. Refer to JEDEC standard JESD51-2 for additional information.

ESD CAUTION



ESD (electrostatic discharge) sensitive device. Charged devices and circuit boards can discharge without detection. Although this product features patented or proprietary protection circuitry, damage may occur on devices subjected to high energy ESD. Therefore, proper ESD precautions should be taken to avoid performance degradation or loss of functionality.

PIN CONFIGURATION AND FUNCTION DESCRIPTIONS

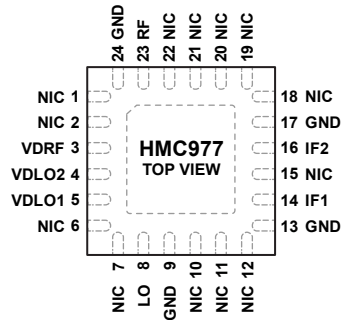

- NOTES
1. NIC = NOT INTERNALLY CONNECTED. DO NOT CONNECT TO THIS PIN.
 2. EPAD. THE EPAD MUST BE CONNECTED TO GND.

21898-102

Figure 2. Pin Configuration

Table 5. Pin Function Descriptions

Pin No.	Mnemonic	Description
1, 2, 6, 7, 10 to 12, 15, 18 to 22	NIC	Not Internally Connected. These pins are not connected internally.
3	VDRF	Power Supply for the RF Low Noise Amplifier. See Figure 3 for the interface schematic.
4	VDLO2	Power Supply for the Second Stage LO Amplifier. See Figure 4 for the interface schematic.
5	VDLO1	Power Supply for the First Stage LO Amplifier. See Figure 5 for the interface schematic.
8	LO	Local Oscillator. This pin is ac-coupled and matched to 50 Ω . See Figure 6 for the interface schematic.
9, 13, 17, 24	GND	Ground Connect. Connect these pins to RF and dc ground. See Figure 7 for the interface schematic.
14	IF1	First Intermediate Frequency Port. This pin is dc-coupled. For applications not requiring operation to dc, block this pin externally using a series capacitor with a value chosen to pass the necessary IF frequency range. For operation to dc, this pin must not source or sink more than 3 mA of current or device nonfunctionality or device failure may result. See Figure 8 for the interface schematic.
16	IF2	Second Intermediate Frequency Port. This pin is dc-coupled. For applications not requiring operation to dc, block this pin externally using a series capacitor with a value chosen to pass the necessary IF frequency range. For operation to dc, this pin must not source or sink more than 3 mA of current or device nonfunctionality or device failure may result. See Figure 8 for the interface schematic.
23	RF	Radio Frequency Port. This pin is ac-coupled and matched to 50 Ω . See Figure 9 for the interface schematic.
	EPAD	Exposed Pad. The EPAD must be connected to GND.

INTERFACE SCHEMATICS

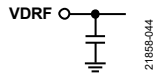

Figure 3. VDRF Interface Schematic

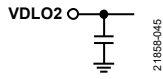

Figure 4. VDLO2 Interface Schematic

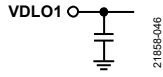

Figure 5. VDLO1 Interface Schematic

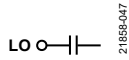

Figure 6. LO Interface Schematic



Figure 7. GND Interface Schematic

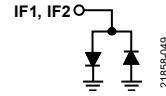

Figure 8. IF1 and IF2 Interface Schematic

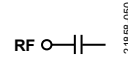

Figure 9. RF Interface Schematic

TYPICAL PERFORMANCE CHARACTERISTICS

DATA TAKEN AS IRM WITH EXTERNAL 90° HYBRID AT THE IF PORTS, IF = 1000 MHz, UPPER SIDEBAND

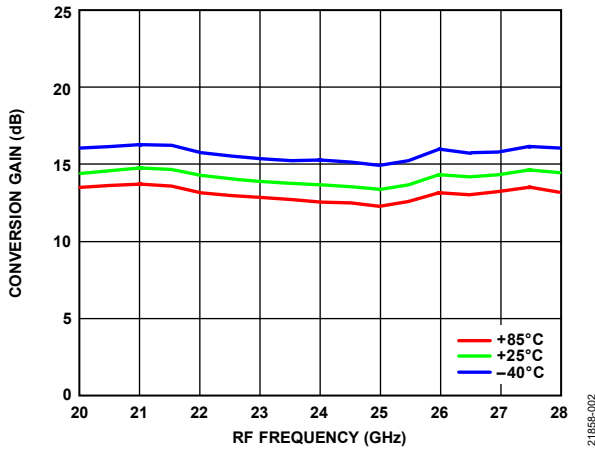

Figure 10. Conversion Gain vs. RF Frequency Over Temperature, LO Drive = 6 dBm

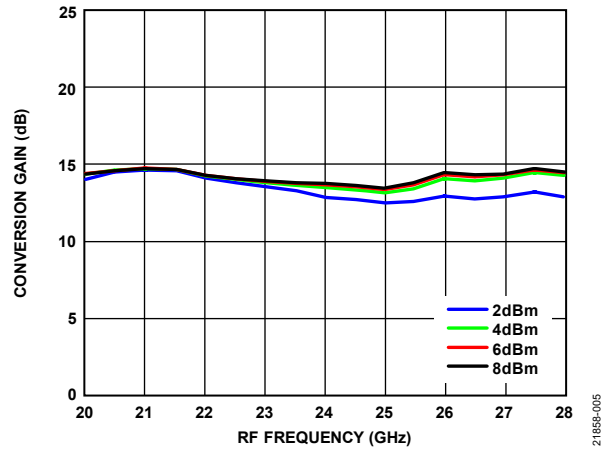

Figure 13. Conversion Gain vs. RF Frequency at Various LO Drives

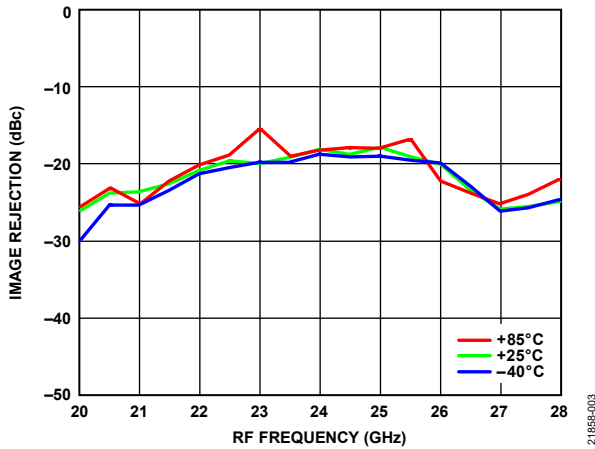

Figure 11. Image Rejection vs. RF Frequency Over Temperature, LO Drive = 6 dBm

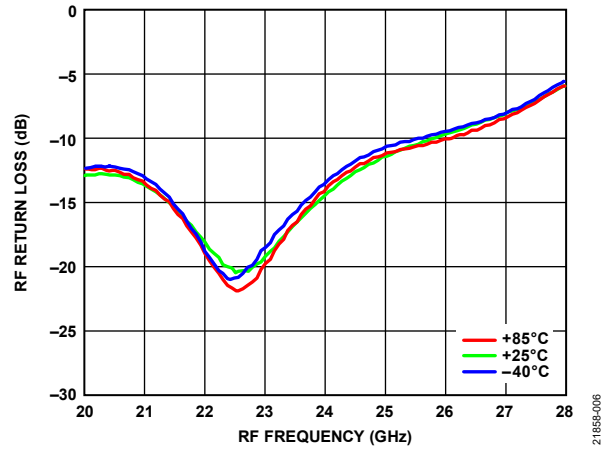

Figure 14. RF Return Loss vs. RF Frequency Over Temperature, LO Frequency = 24 GHz

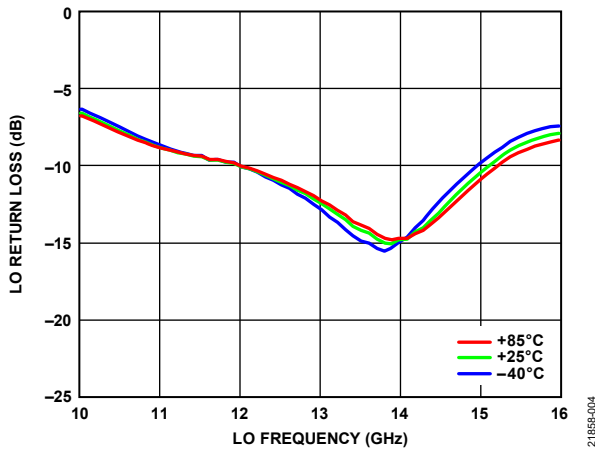

Figure 12. LO Return Loss vs. LO Frequency Over Temperature, LO Drive = 6 dBm

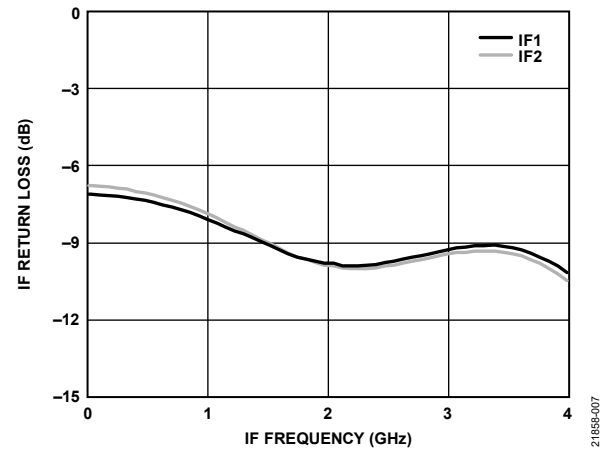

Figure 15. IF Return Loss vs. IF Frequency, LO Frequency = 24 GHz, LO Drive = 6 dBm, Data Taken Without External 90° Hybrid

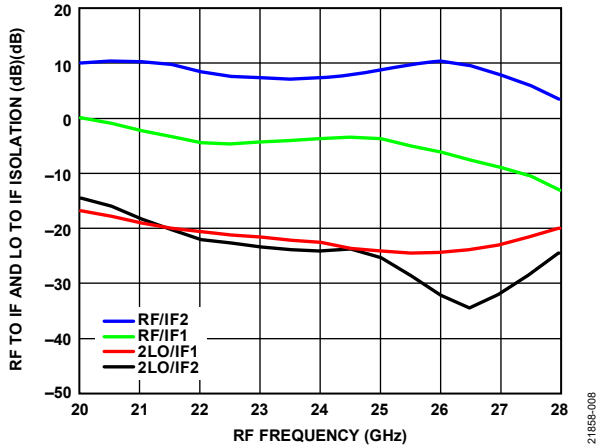

Figure 16. RF to IF and LO to IF Isolation vs. RF Frequency, LO Drive = 6 dBm, Data Taken Without External 90° Hybrid

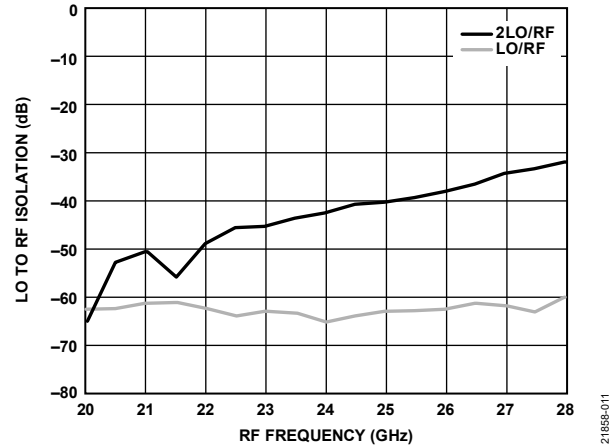

Figure 19. LO to RF Isolation vs. RF Frequency LO Drive = 6 dBm, Data Taken Without External 90° Hybrid

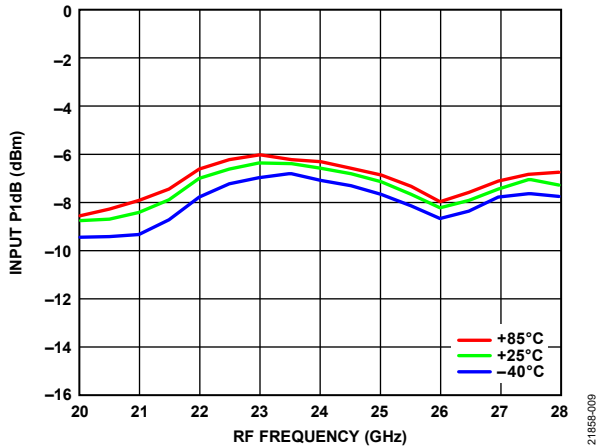

Figure 17. Input P1dB vs. RF Frequency Over Temperature, LO Drive = 6 dBm

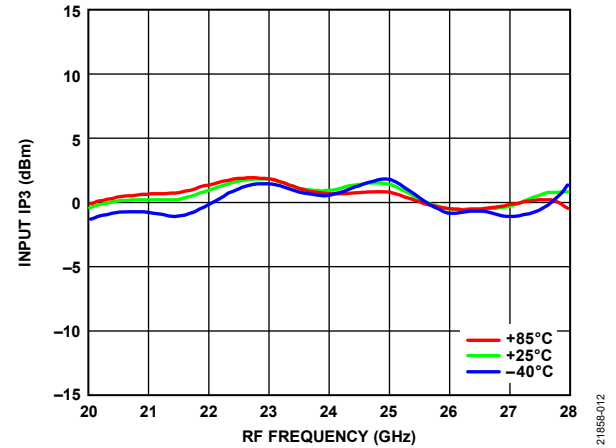

Figure 20. Input IP3 vs. RF Frequency Over Temperature, LO Drive = 6 dBm

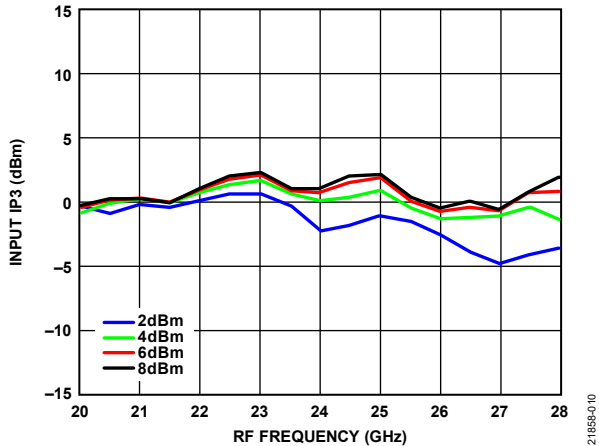

Figure 18. Input IP3 vs. RF Frequency at Various LO Drives

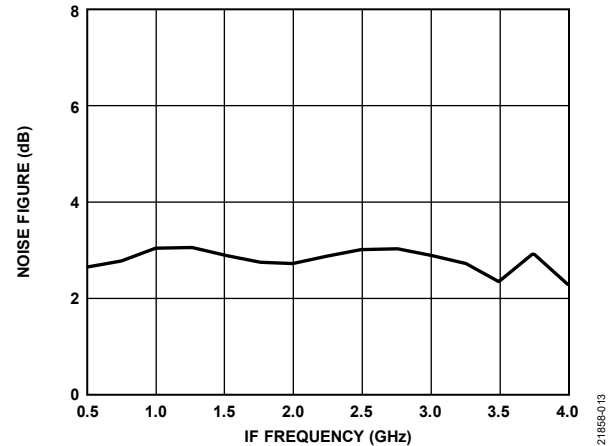

Figure 21. Noise Figure vs. IF Frequency, LO Frequency = 10 GHz, LO Drive = 6 dBm, Data Taken Without External 90° Hybrid

QUADRATURE CHANNEL DATA TAKEN WITHOUT 90° HYBRID AT THE IF PORTS, IF = 1000 MHZ, UPPER SIDEBAND

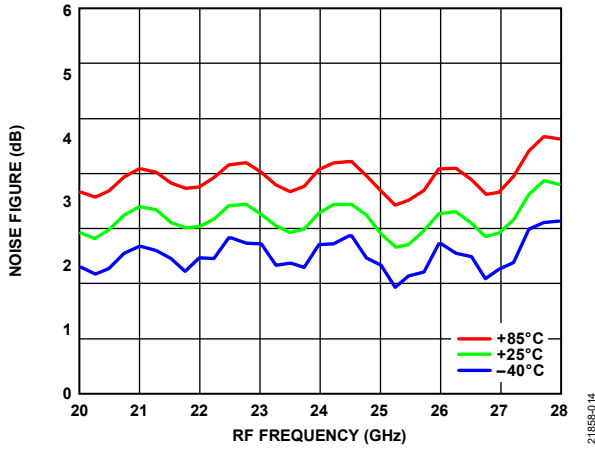

Figure 22. Noise Figure vs. RF Frequency Over Temperature, LO Drive = 6 dBm

21858-014

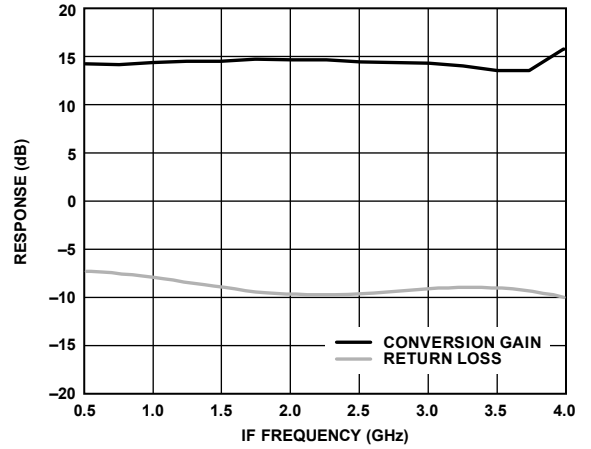

Figure 24. Conversion Gain and Return Loss Over IF Bandwidth

21858-016

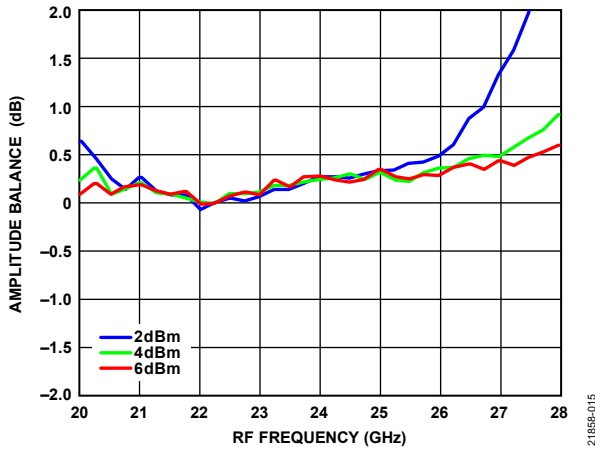

Figure 23. Amplitude Balance vs. RF Frequency at Various LO Drives

21858-015

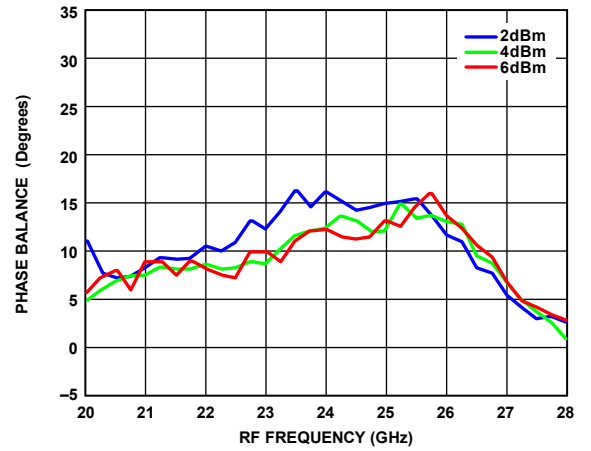

Figure 25. Phase Balance vs. RF Frequency at Various LO Drives

21858-017

DATA TAKEN AS IRM WITH EXTERNAL 90° HYBRID AT THE IF PORTS, IF = 1000 MHz, LOWER SIDEBAND

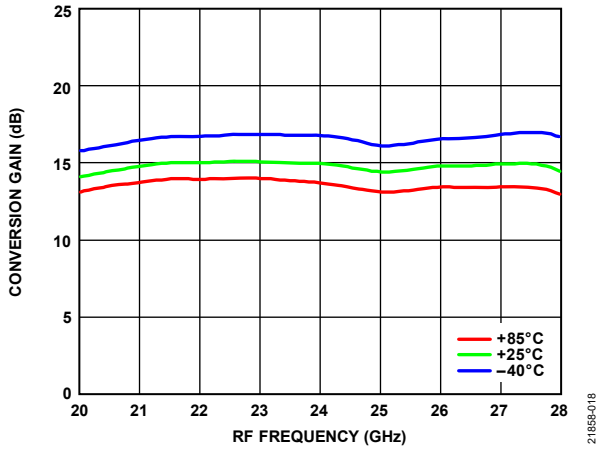

Figure 26. Conversion Gain vs. RF Frequency Over Temperature, LO Drive = 6 dBm

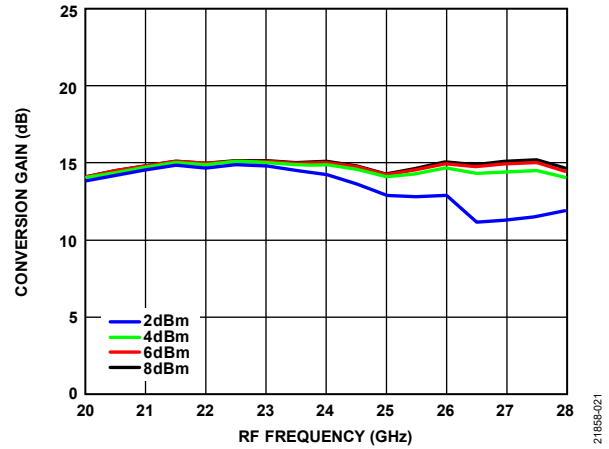

Figure 29. Conversion Gain vs. RF Frequency at Various LO Drives

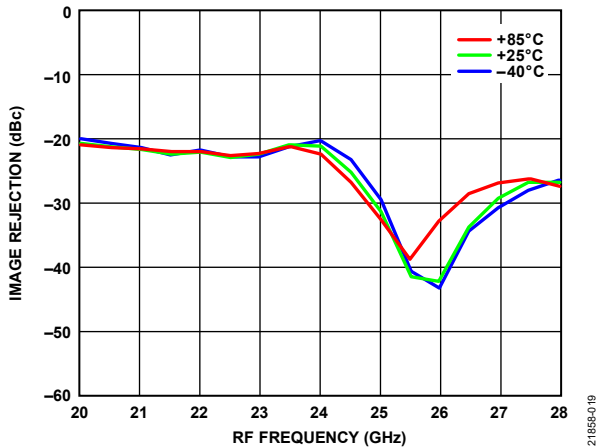

Figure 27. Image Rejection vs. RF Frequency Over Temperature, LO Drive = 6 dBm

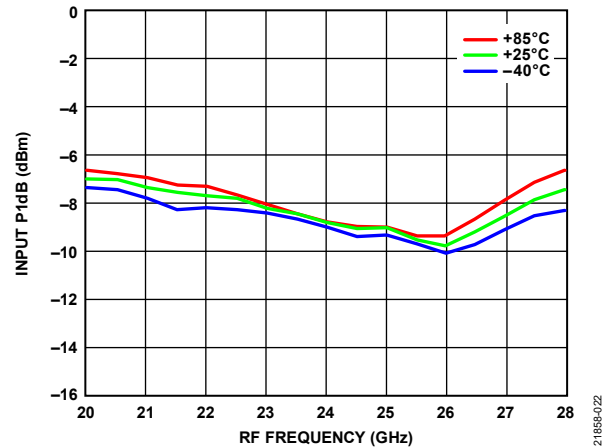

Figure 30. Input P1dB vs. RF Frequency Over Temperature, LO Drive = 6 dBm

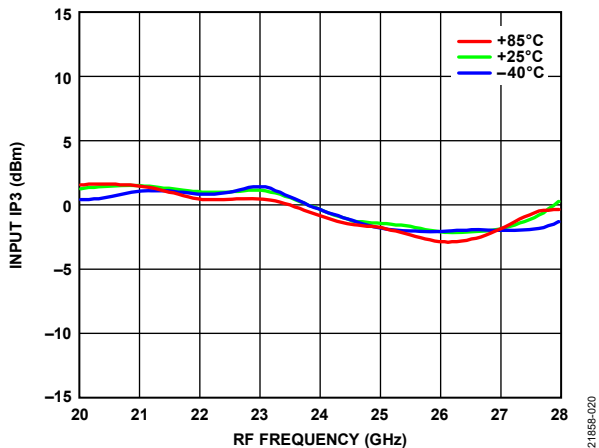

Figure 28. Input IP3 vs. RF Frequency Over Temperature, LO Drive = 6 dBm

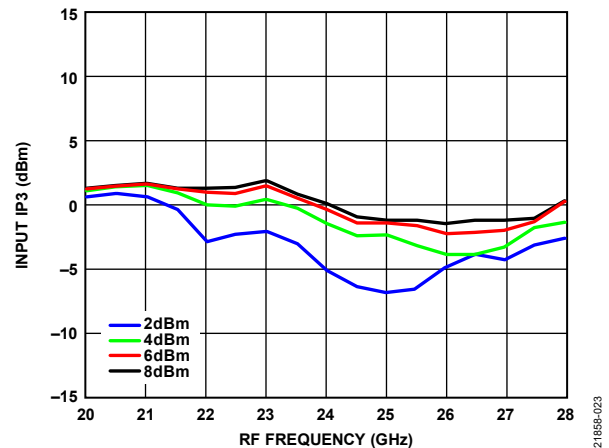

Figure 31. Input IP3 vs. RF Frequency at Various LO Drives

DATA TAKEN AS IRM WITH EXTERNAL 90° HYBRID AT THE IF PORTS, IF = 2000 MHz, UPPER SIDEBAND

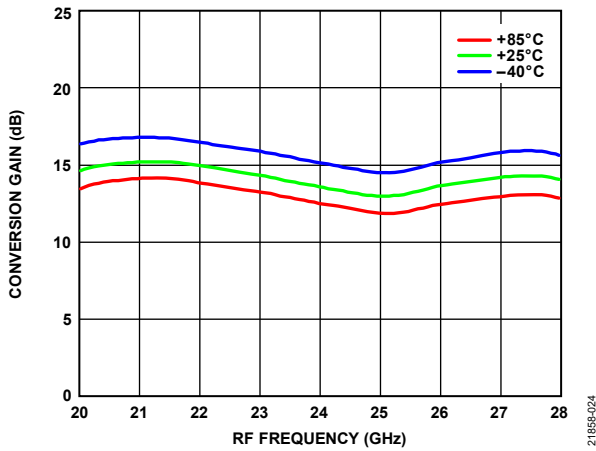

Figure 32. Conversion Gain vs. RF Frequency Over Temperature, LO Drive = 6 dBm

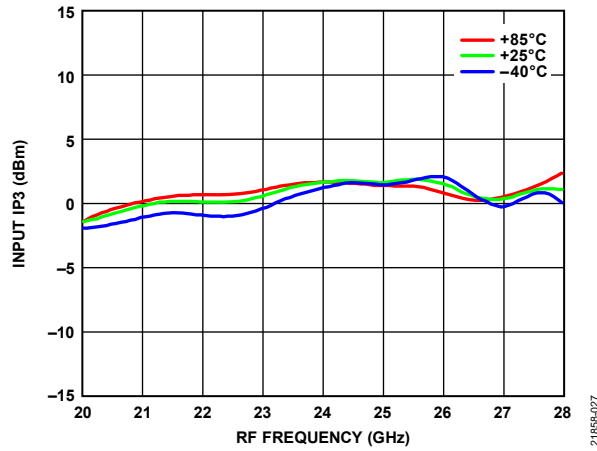

Figure 35. Input IP3 vs. RF Frequency Over Temperature, LO Drive = 6 dBm

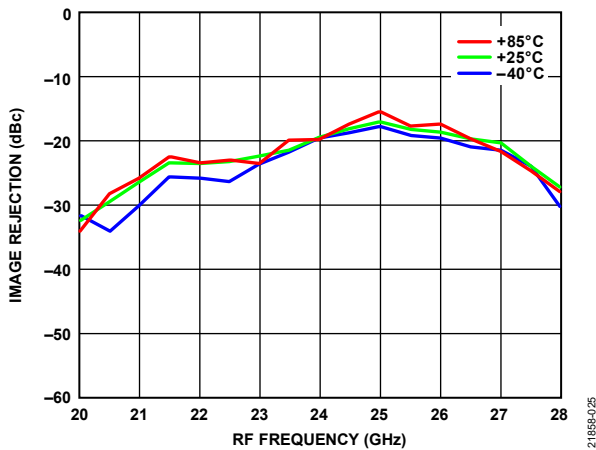

Figure 33. Image Rejection vs. RF Frequency Over Temperature, LO Drive = 6 dBm

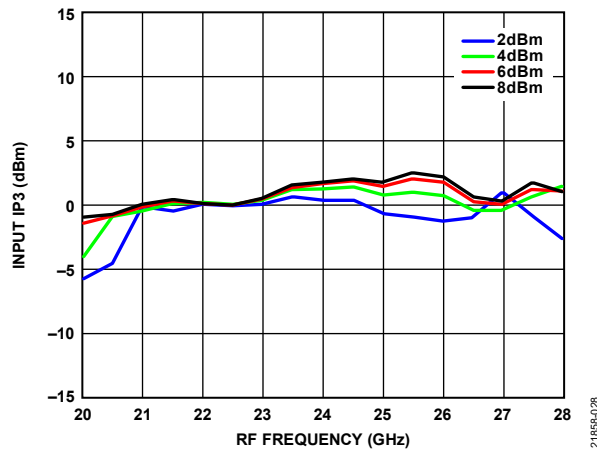

Figure 36. Input IP3 vs. RF Frequency at Various LO Drives

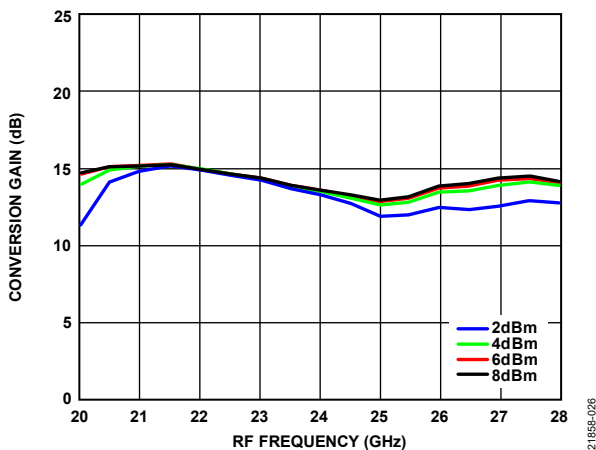

Figure 34. Conversion Gain vs. RF Frequency at Various LO Drives

21859-024

21859-027

21859-025

21859-028

21859-026

DATA TAKEN AS IRM WITH EXTERNAL 90° HYBRID AT THE IF PORTS, IF = 2000 MHz, LOWER SIDEBAND

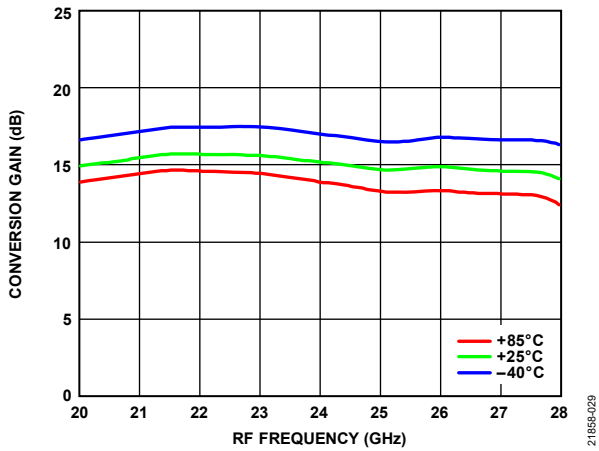

Figure 37. Conversion Gain vs. RF Frequency Over Temperature, LO Drive = 6 dBm

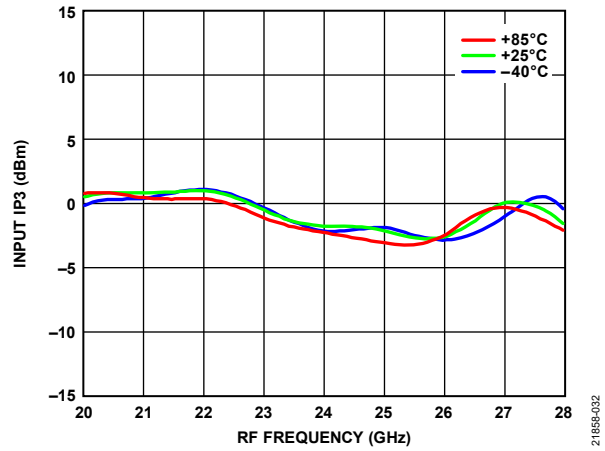

Figure 40. Input IP3 vs. RF Frequency Over Temperature, LO Drive = 6 dBm

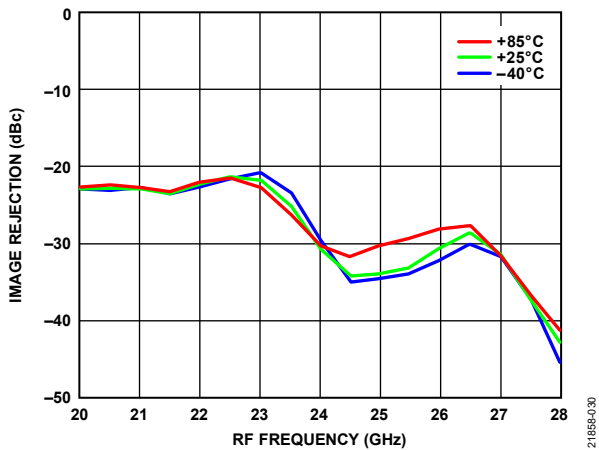

Figure 38. Image Rejection vs. RF Frequency Over Temperature, LO Drive = 6 dBm

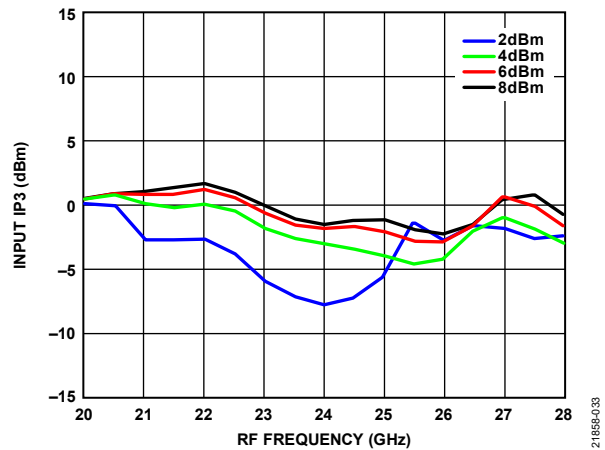

Figure 41. Input IP3 vs. RF Frequency at Various LO Drives

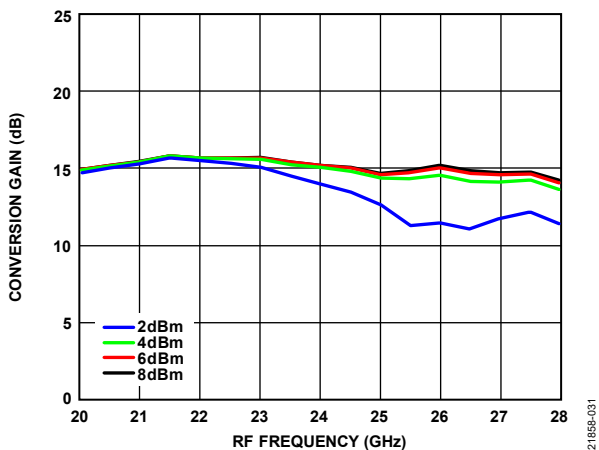

Figure 39. Conversion Gain vs. RF Frequency at Various LO Drives

21859-029

21859-032

21859-030

21859-033

21859-031

DATA TAKEN AS IRM WITH EXTERNAL 90° HYBRID AT THE IF PORTS, IF = 3300 MHz, UPPER SIDEBAND

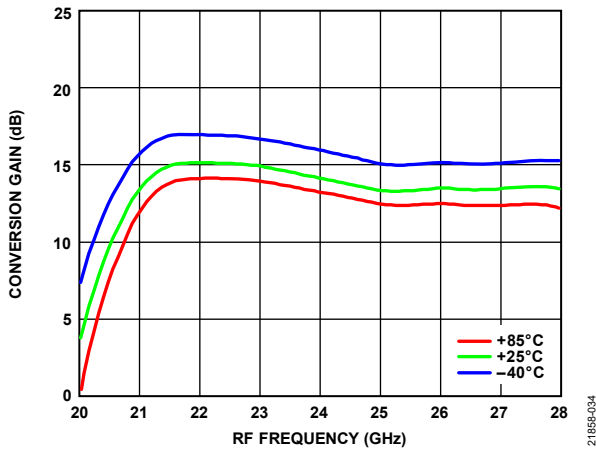

Figure 42. Conversion Gain vs. RF Frequency Over Temperature, LO Drive = 6 dBm

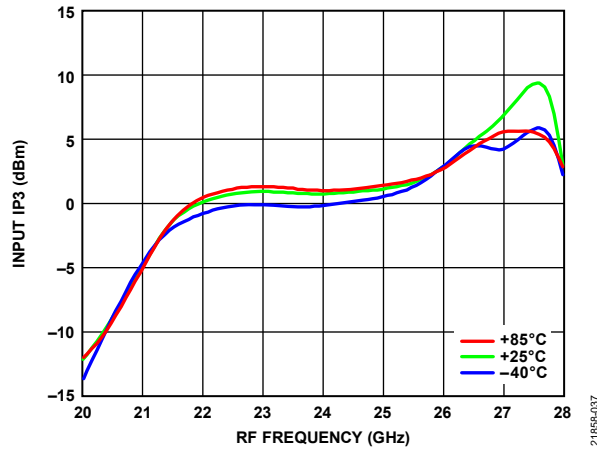

Figure 45. Input IP3 vs. RF Frequency Over Temperature, LO Drive = 6 dBm

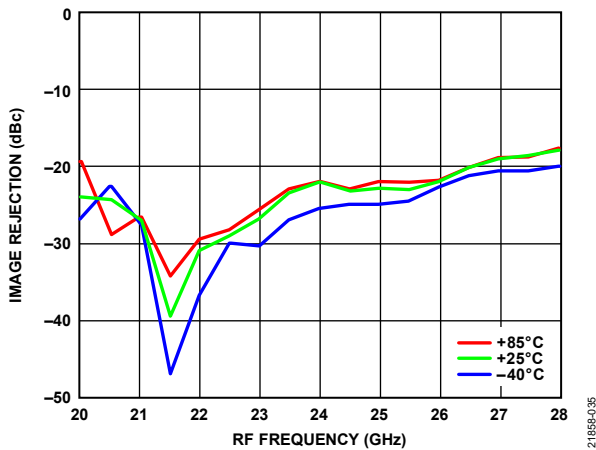

Figure 43. Image Rejection vs. RF Frequency Over Temperature, LO Drive = 6 dBm

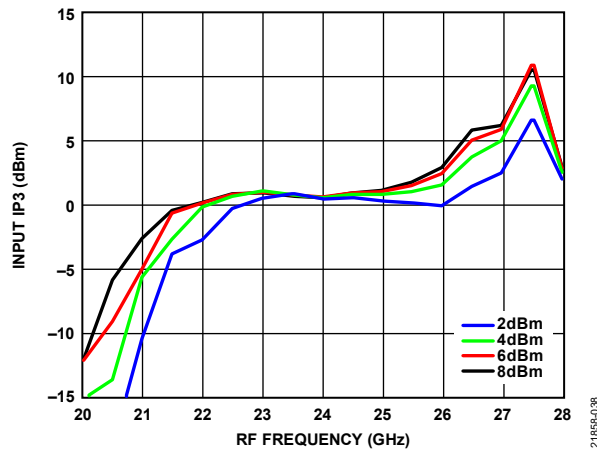

Figure 46. Input IP3 vs. RF Frequency at Various LO Drives

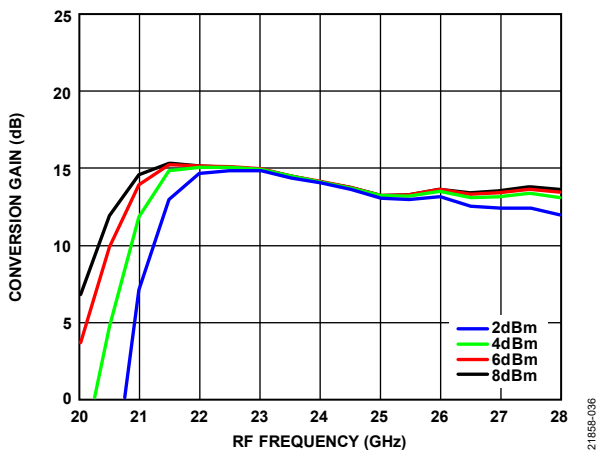

Figure 44. Conversion Gain vs. RF Frequency at Various LO Drives

21859-034

21859-037

21859-035

21859-038

21859-036

DATA TAKEN AS IRM WITH EXTERNAL 90° HYBRID AT THE IF PORTS, IF = 3300 MHz, LOWER SIDEBAND

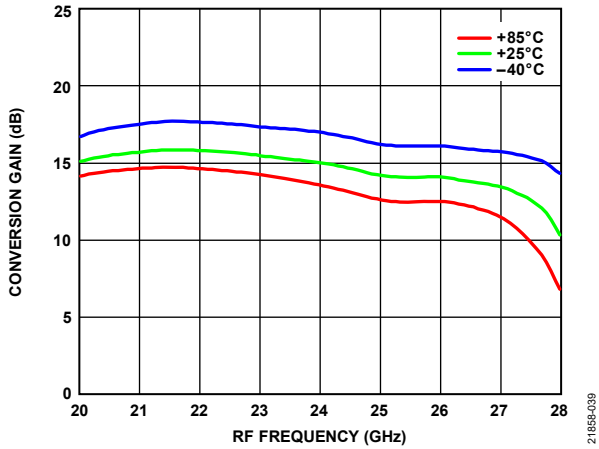

Figure 47. Conversion Gain vs. RF Frequency Over Temperature, LO Drive = 6 dBm

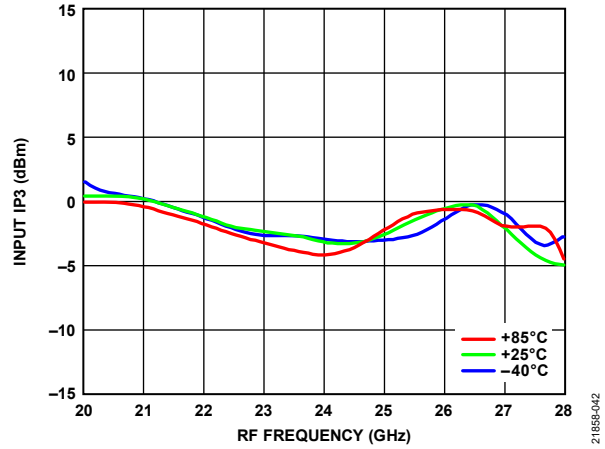

Figure 50. Input IP3 vs. RF Frequency Over Temperature, LO Drive = 6 dBm

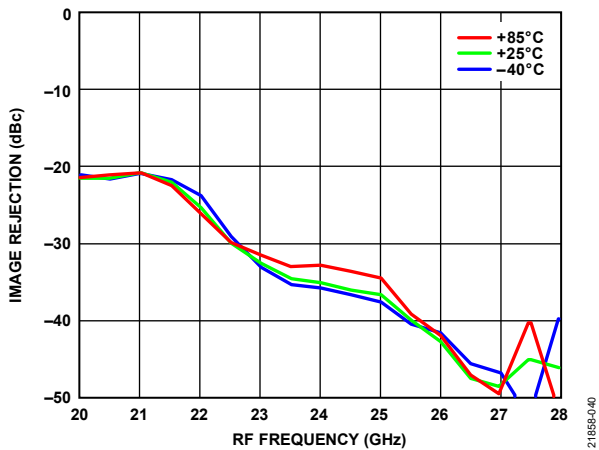

Figure 48. Image Rejection vs. RF Frequency Over Temperature, LO Drive = 6 dBm

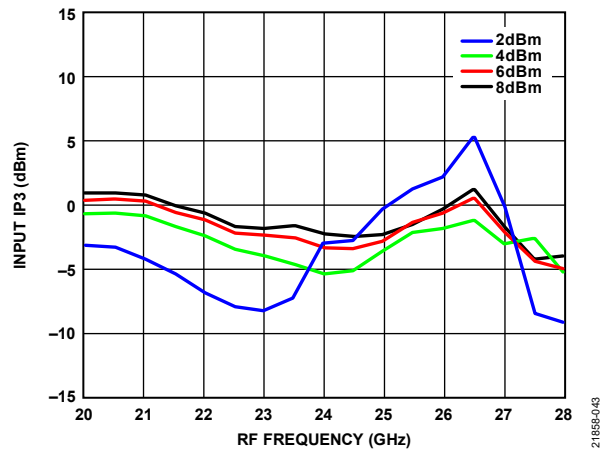

Figure 51. Input IP3 vs. RF Frequency at Various LO Drives

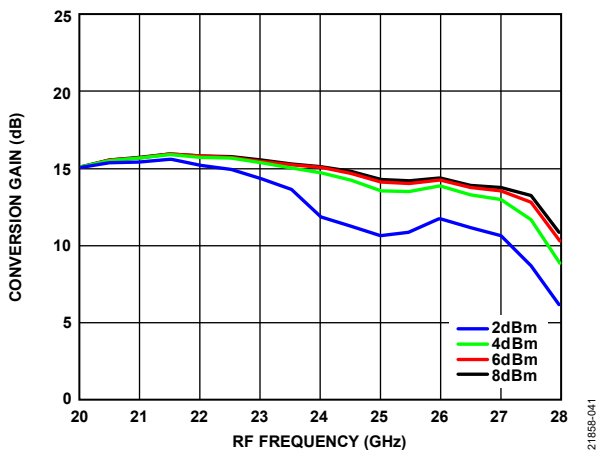

Figure 49. Conversion Gain vs. RF Frequency at Various LO Drives

21859-039

21859-042

21859-040

21859-043

21859-041

SPURIOUS PERFORMANCE***M × N Spurious Outputs, IF = 1000 MHz***

RF = 24 GHz, and RF input power = -20 dBm. LO frequency = 11.5 GHz, and LO drive = 4 dBm. All values are in dBc below IF power level (RF - 2 × LO). Spur values are (M × RF) - (N × LO).

N/A means not applicable.

		N × LO				
		0	1	2	3	4
M × RF	0	N/A	-22.6	-7.4	-28.8	-37.2
	1	-20	-29.3	0	-33	-37.3
	2	-72.6	-72.6	-57.6	-43.6	-51.6
	3	N/A	N/A	-74.6	-74.6	-74.6
	4	N/A	N/A	N/A	N/A	N/A

THEORY OF OPERATION

The HMC977 is a compact, GaAs, MMIC, I/Q downconverter in a leadless, RoHS compliant, SMT package. The device can be used as either an image reject mixer or a SSB upconverter. The mixer uses two standard, double balanced, mixer cells and a

90° hybrid. This device is a smaller alternative to a hybrid style image reject mixer and a SSB upconverter assembly. The HMC977 eliminates the need for wire bonding, allowing the use of the surface-mount manufacturing techniques.

APPLICATIONS INFORMATION

Figure 52 shows the typical application circuit for the HMC977. To select the appropriate sideband, an external 90° hybrid coupler is needed. For applications not requiring operation to dc, use an off chip dc blocking capacitor. The common-mode voltage for each IF port is 0 V.

To select the lower sideband, connect the IF2 pin to the 90° port of the hybrid and the IF1 pin to the 0° port of the hybrid. To select the upper sideband (low side LO), connect the IF2 pin to the 0° port of the hybrid and the IF1 pin to the 90° port of the hybrid.

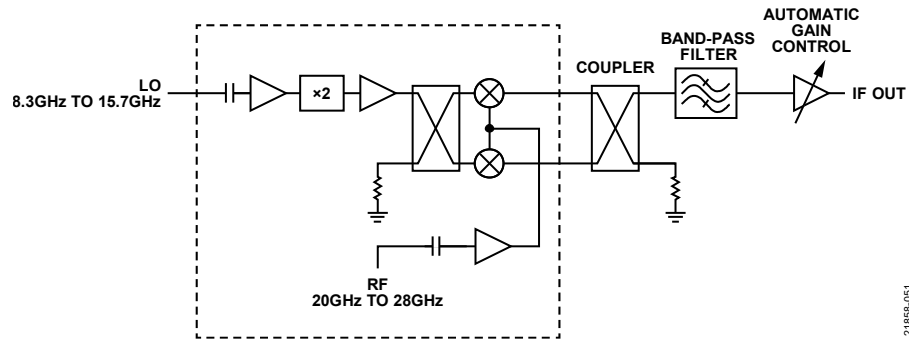

Figure 52. Typical Application Circuit

21858-051

EVALUATION PCB

It is recommended to use RF circuit design techniques with the circuit board used in the application. Signal lines must have 50 Ω impedance, and the package ground leads and exposed paddle must be connected directly to the ground plane similar to that shown Figure 54. A sufficient number of via holes must be used to connect the top and bottom ground planes. The evaluation circuit board shown in Figure 53 is available from Analog Devices, Inc., upon request.

Table 6. List of Materials for Evaluation PCB 131656¹

Item	Description
J1	PCB mount, Subminiature Version A (SMA), RF connector, SRI
J2, J3	PCB mount K connectors, SRI
J5 to J8	DC pins
C1, C4, C7	100 pF capacitors, 0402 package
C2, C5, C8	10 nF capacitors, 0402 package
C3, C6, C9	4.7 μF capacitors, Case A package
U1	HMC977
PCB ²	131653 evaluation board

¹ Reference this number when ordering complete evaluation PCB.

² Circuit board material: Rogers 4350.

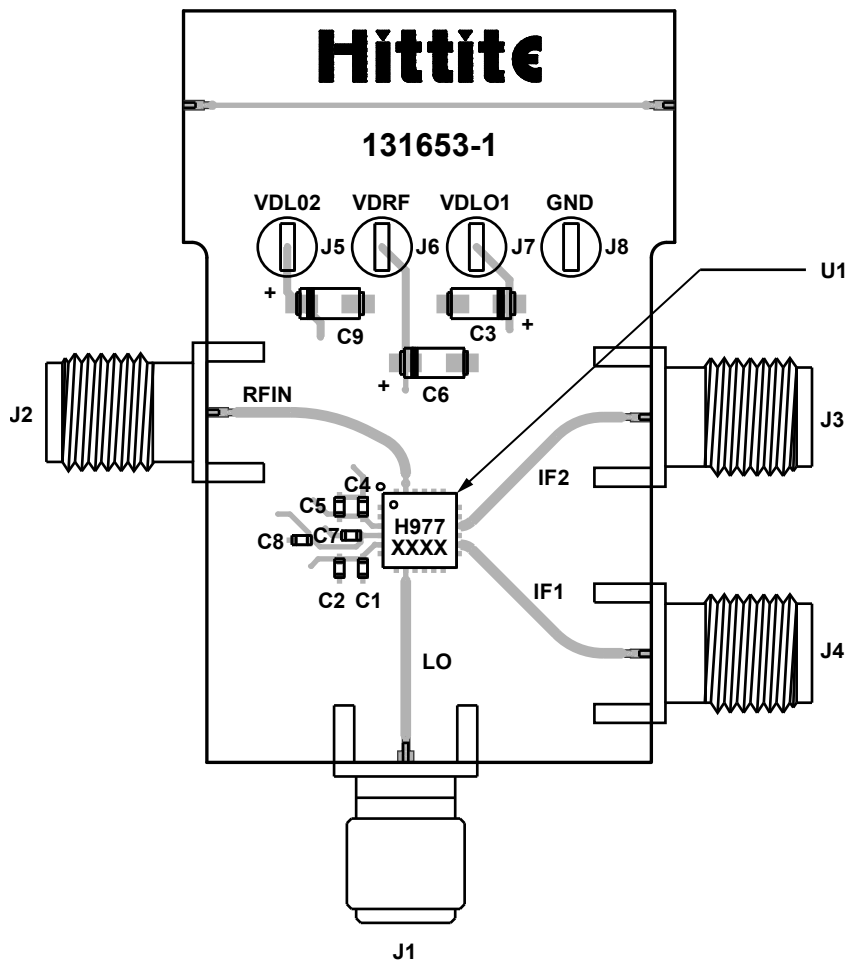

Figure 53. Evaluation PCB

21E984652

LAYOUT

Solder the exposed pad on the underside of the HMC977 to a low thermal and electrical impedance ground plane. This pad is typically soldered to an exposed opening in the solder mask on the evaluation board. Connect these ground vias to all other ground layers on the evaluation board to maximize heat dissipation from the device package. Figure 54 shows the PCB land pattern footprint for the HMC977 evaluation board.

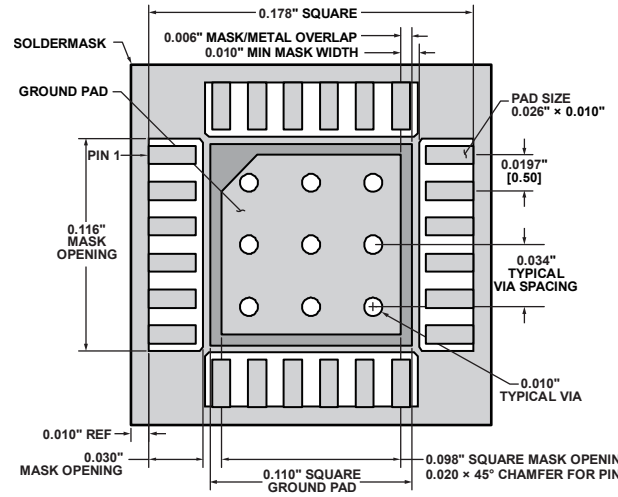

Figure 54. 131656-HMC977LP4E PCB Land Pattern Footprint

211856-054