

## HTU21P(F) RH/T SENSOR IC

### Miniature Relative Humidity and Temperature

#### SPECIFICATIONS

- DFN type package
- Relative Humidity and Temperature Analog Output, PWM interface
- Fully calibrated
- Lead free sensor, reflow solderable
- Low power consumption
- Fast response time

HTU21P(F) is a new humidity and temperature sensor by MEAS. Setting new standards in terms of size and intelligence, it is embedded in a reflow solderable Dual Flat No leads (DFN) package of 3 x 3 x 0.9 mm foot print. This sensor provides calibrated, linearized signals in analog pulse width modulated (PWM) format.

HTU21P(F) humidity sensors are dedicated humidity and temperature plug and play transducers for OEM applications where reliable and accurate measurements are needed. These low power sensors are designed for high volume and cost sensitive applications with tight space constraints.

PWM signal runs on a base frequency of 120Hz, the data signal is provided on SDA line. Pulling SCL high or low allows for switching between humidity and temperature, respectively. The sensor measures twice per second. The PWM signal may be converted to an analog ratiometric interface by adding a low pass filter.

With MEAS' improvements and miniaturization of the sensor, the performance-to-price ratio has been improved – and eventually, any device should benefit from the cutting edge energy saving operation mode. HTU21 is also available with digital I<sup>2</sup>C (HTU21D(F)).

Optional PTFE filter/membrane (F) protects HTU21P analog humidity sensors against dust and water immersion, as well as against contamination by particles. PTFE filter/membrane preserves a high response time. The white PTFE filter/membrane is directly stuck on the sensor housing. This membrane is allowing an IP67 compliance protection.

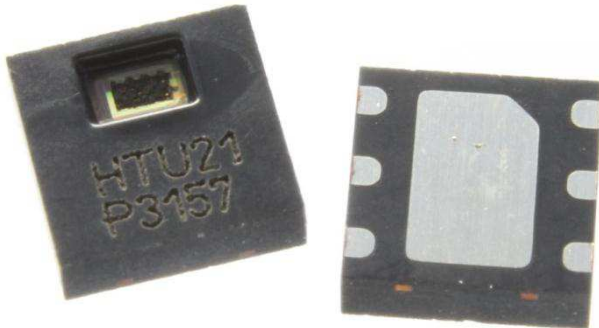

#### FEATURES

- Full interchangeability with no
- Instantaneous desaturation after
- Compatible with automatized
- Individual marking for compliance to

#### APPLICATIONS

- Automotive: defogging, HVAC
- Home Appliance
- Medical
- Printers
- Humidifier

**NOMENCLATURE**

**HTU2XY(F)**

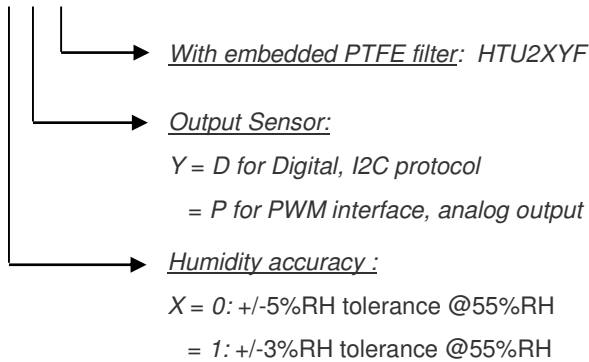

HTU2XY Modules



HTU2XYF Modules

**PERFORMANCE SPECS**

**MAXIMUM RATINGS**

Ratings	Symbol	Value	Unit
Storage Temperature	Tstg	-40 to 125	°C
Supply Voltage (Peak)	Vcc	3.8V	Vdc
Humidity Operating Range	RH	0 to 100	%RH
Temperature Operating Range	Ta	-40 to +125	°C
VDD to GND		-0.3 to 3.6	Vdc
Digital I/O pins (DATA/SCK) to VDD		-0.3 to VDD+0.3	Vdc
Input current on any pin		-10 to +10	mA

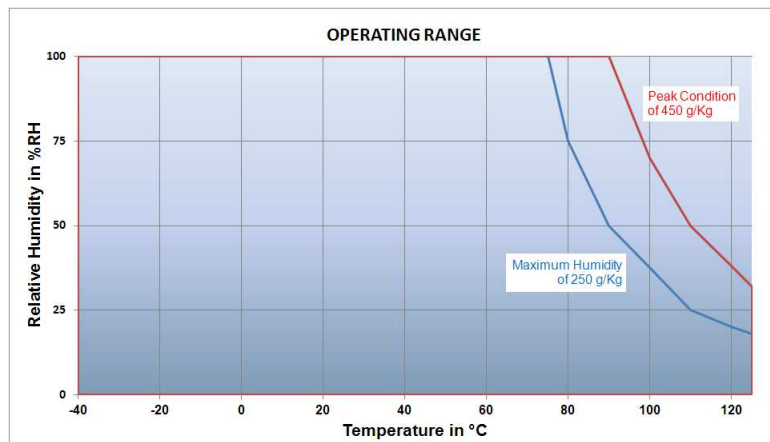

## HTU21P(F) RH/T SENSOR IC

Miniature Relative Humidity and Temperature

Graph above show peak conditions: less than 10% of the operating time

Exposure to absolute maximum rating conditions for extended periods may affect the sensor reliability.

### ELECTRICAL AND GENERAL ITEMS

(@T = 25°C, @Vdd = 3V)

Characteristics	Symbol	Min	Typ	Max	Unit
Voltage Supply	VDD	1.5	3.0	3.6	Vdc
Current consumption	idd		5	14	μA
Power Dissipation			15	50	μW
Communication	Analog output, PWM interface				
PWM Frequency (1)		108	120	132	Hz
Temperature drift of PWM frequency		-0.07		-0.12	Hz/°C
Measurement Frequency			2		Hz
Switch RH/T on DATA	SCK high → RH, SCK low → T				
Storage	-40°C/125°C				

(1) Conditions: Temp=40°C

### SENSOR PERFORMANCE

#### RELATIVE HUMIDITY

(@T = 25°C, @Vdd = 3V)

Characteristics	Symbol	Min	Typ	Max	Unit
Resolution	10 bit		0.04		%RH
Humidity Operating Range	RH	0		100	%RH
Relative Humidity Accuracy @25°C (10%RH to 95%RH)	typ		±2		%RH
	max		See graph 1		%RH
Replacement	fully interchangeable				
Temperature coefficient (from 0°C to 80°C)	Tcc			-0.15	%RH/°C
Humidity Hysteresis			±1		%RH
Recovery time after 150 hours of condensation	t		10		s
Long term drift			0.5		%RH/yr
Response Time (at 63% of signal) from 33% to 75%RH	TRH		5	10	s

(1) Typical values are recommended for calculating energy consumption while maximum values shall be applied for calculating waiting times in communication.

(2) At 1m/s air flow

**GRAPH 1 : RELATIVE HUMIDITY ERROR BUDGET CONDITIONS AT 25°C**

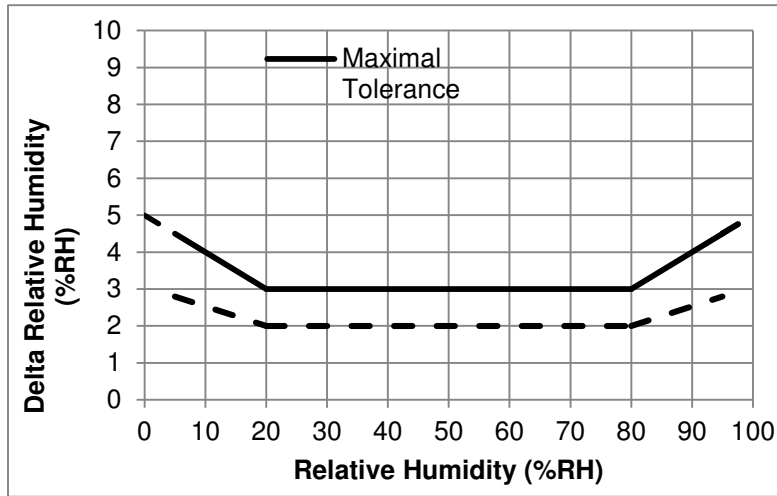

- HTU21P(F) sensors are specified for optimum accuracy measurements within 5 to 95%RH.
- Operation out of this range (< 5% or > 95% RH, including condensation) is however possible.

**TEMPERATURE COEFFICIENT COMPENSATION EQUATION**

Using the following temperature coefficient compensation equation will guarantee Relative Humidity accuracy given p.3, from 0°C to 80°C:

$$RH_{compensatedT} = RH_{actualT} + (25 - T_{actual}) \times CoeffTemp$$

- RH<sub>actualT</sub> Ambient humidity in %RH, computed from HTU21P(F) sensor
- T<sub>actual</sub> Humidity cell temperature in °C, computed from HTU21P(F) sensor
- CoeffTemp Temperature coefficient of the HTU21P(F) in %RH/°C

**TEMPERATURE**

Characteristics		Symbol	Min	Typ	Max	Unit
Resolution	12 bit			0.01		°C
Temperature Operating Range		T	-40		+125	°C
Temperature Accuracy @25°C	typ			±0.3		°C
	max			See graph 2		°C
Replacement			fully interchangeable			
Long term drift				0.04		°C/yr
Response Time (at 63% of signal) from 15°C to 45°C (2)		T <sub>T</sub>		10		s

(1) Typical values are recommended for calculating energy consumption while maximum values shall be applied for calculating waiting times in communication.

(2) At 1m/s air flow

**GRAPH2 : TEMPERATURE ERROR BUDGET**

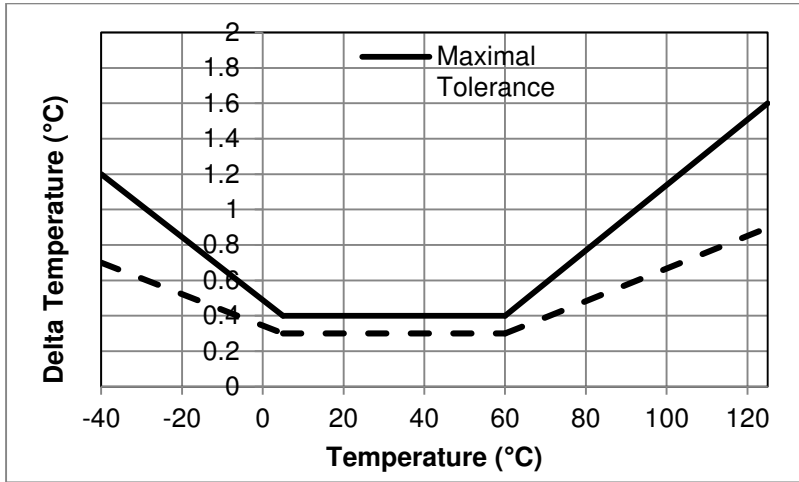

**USER GUIDE HTU21P(F)**

**APPLICATION INFORMATION**

- **Soldering instructions: Lead free reflow soldering recommended process**

For soldering HTU21P(F) sensor standard reflow soldering ovens may be used.

HTU21P(F) sensor as a humidity sensitive component (as classified by IPC/JEDEC J-STD-020 or equivalent documented procedure with peak temperature at 260°C during up to 30 seconds for Pb-free assembly in IR/convection reflow ovens) must be handled in a manner consistent with IPC/JEDEC J-STD-033 or an equivalent documented procedure. IPC-1601 provides humidity control, handling and packing of PCBs.

The HTU21P(F) sensor is qualified to withstand one lead free reflow soldering recommended process profile below according to JEDEC standard.

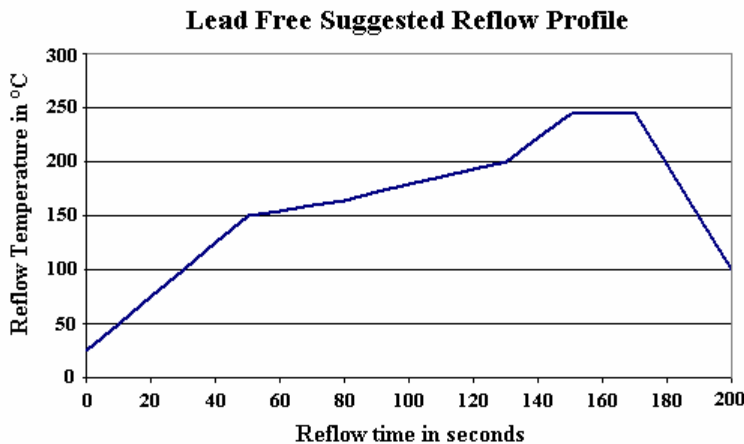

Mount parts within 24 hours after printing solder paste to avoid potential dry up.

For manual soldering, contact time must be limited to 5 seconds at up to 350°C.

For the design of the HTU21P(F) sensor footprint, it is recommended to use dimensions according to figure below.

## HTU21P(F) RH/T SENSOR IC

Miniature Relative Humidity and Temperature

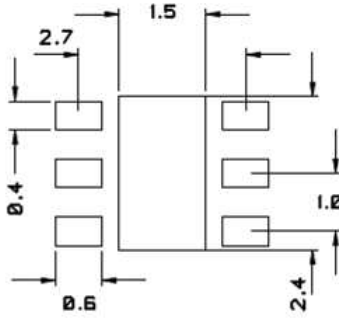

*Recommended footprint for HTU21P(F) sensors. Values in mm.*

No specific conditioning of devices is necessary after soldering process, either manual or reflow soldering. Optimized performance, in case of metrological measurements, can be reached with stabilization of devices (24 hours at 25°C/55%RH). Similar process is advised after exposure of the devices to extreme relative humidity conditions.

- **Storage Conditions and Handling Instructions**

It is recommended to store HTU21P(F) sensor in its original packaging at following conditions: Temperature shall be in the range of -40°C – 125°C.

- **Temperature effects**

Relative humidity reading strongly depends on temperature. Therefore, it is essential to keep humidity sensors at the same temperature as the air of which the relative humidity is to be measured.

In case of testing or qualification the reference sensor and test sensor must show equal temperature to allow for comparing humidity readings.

The HTU21P(F) sensor should be mounted in a way that prevents heat transfer from electronic sensor or that keeps it as low as possible. Advice can be ventilation, reduction of copper layers between the HTU21P(F) sensor and the rest of the PCB or milling a slit into the PCB around the sensor (1mm minimum width).

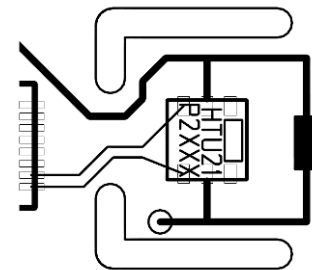

*Example of HTU21P(F) sensor mounting with slits milled to minimize heat transfer*

- **Materials Used for Sealing / Mounting**

For sealing and gluing (use sparingly), use high filled epoxy for electronic packaging and silicone. For any specific material please request to [humidity.application@te.com](mailto:humidity.application@te.com).

- **Wiring Considerations and Signal Integrity**

Power supply pins (VDD, GND) must be decoupled with a 100nF capacitor. Capacitor should be placed as close as possible to the sensor.

## HTU21P(F) RH/T SENSOR IC

Miniature Relative Humidity and Temperature

- **ESD (Electrostatic Discharge)**

ESD immunity is qualified according to:

- JEDEC JESD22-A114 method (Human Body Model at  $\pm 4\text{kV}$ ) for pads & open window
- JEDEC JESD22-A115 method (Machine Model  $\pm 200\text{V}$ )
- ESDA ESD-STM5.3.1-1999 and AEC-Q100-011 (charged device model, 750V corner pins, 500V other pins)

Latch-up immunity is provided at a force current of  $\pm 100\text{mA}$  with  $T_{\text{amb}}=25^{\circ}\text{C}$  according to JEDEC JESD78. For exposure beyond named limits the sensor need additional protection circuit.

### INTERFACE SPECIFICATION

N°	Function	Comment
1	DATA	Data bit-stream
2	GND	Ground
3	NC	Must be left unconnected
4	NC	Must be left unconnected
5	VDD	Supply Voltage
6	SCK	Selector for RH or T
PAD		Ground or unconnected



The image shows a physical HTU21P3157 sensor chip on the left and its pinout diagram on the right. The pinout diagram shows a 6-pin package with pins labeled DATA, GND, NC, SCK, VDD, and NC from left to right.

- **Power Pins (VDD, GND)**

The supply voltage of HTU21P(F) sensors must be in the range of 1.5VDC - 3.6VDC. Recommended supply voltage is 3VDC (regulated).

However the typical application circuit includes a 100nF decoupling capacitor between VDD and GND, placed as close as possible to the sensor.

- **Output Selector Pad (SCK)**

SCK is used to select relative humidity or temperature output. SCK high yields humidity output, SCK low yields temperature. Please note that a change of SCK will affect the output on DATA after maximum 1.2 seconds.

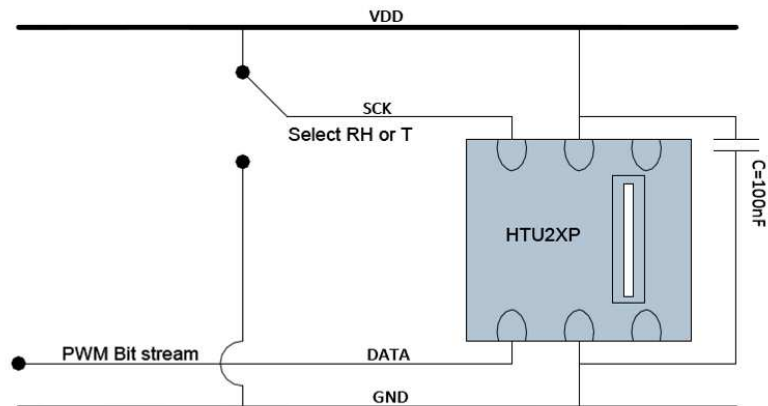

*Typical application circuit, including decoupling of VDD and GND by a capacitor.*

## HTU21P(F) RH/T SENSOR IC

Miniature Relative Humidity and Temperature

- **Bit Stream Pad (DATA)**

On DATA line, the HTU21P(F) sensor is providing PWM output. The signal is carrying relative humidity or temperature data depending on SCK being high or low, respectively. See Table next page for detailed I/O characteristic of the HTU21P(F) sensor.

### ELECTRICAL CHARACTERISTICS

- **Input/output characteristics**

(VDD=1.5V to 3.6V, Temperature=-40°C to 125°C unless otherwise noted)

Characteristics	Symbol	Min	Typ	Max	Unit
Output Low Voltage	VOL	0		30%VDD	V
Output High Voltage	VOH	70%VDD		VDD	V
Output Sink Current	IOL			40	μA

### COMMUNICATION WITH HTU21P(F) SENSOR

- **Start-up sensor**

As a first step, the HTU21P(F) sensor is powered up to VDD (between 1.5V and 3.6V). Then the HTU21P(F) sensor starts measuring and providing data on PWM bit-stream.

- **PWM Specification**

Pulse Width Modulation (PWM) runs on a constant frequency and the measured information is provided as duty cycle on that frequency. Such information is measured humidity for SCK pulled high and temperature for SCK pulled low.

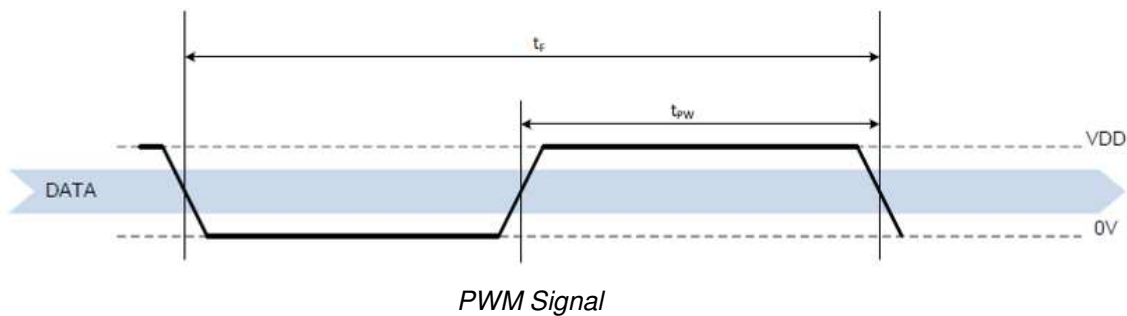

Base frequency runs constantly at approximately 120 Hz, hence  $t_f$  is about 8.3ms. The signal is provided on  $t_{PW}$  as a ratio of  $t_f$ . The measured data – either relative humidity or temperature – is provided as ratio of  $t_{PW}$  and  $t_f$ .  $t_{PW}$  shall always be given as ratio of  $t_f$  to make it independent of variations of the base frequency.

### CONVERSION OF SIGNAL OUTPUTS

Resolution is set to 10 bit relative humidity and 12 bit temperature reading and cannot be changed. The sensor reading is linear and hence it can be converted to a physical value by an easy linear equation.

To accommodate/adapt any process variation (nominal capacitance value of the humidity die), tolerances of the sensor above 100%RH and below 0%RH must be considered. As a consequence:

- RH output can reach 118%RH and above this value, there will have a clamp of the RH output to this value.
- RH output can reach -6%RH and below this value, there will have a clamp of the RH output to this value.



- **Relative Humidity conversion**

With the relative humidity signal output  $S_{RH}$ , the relative humidity is obtained using the following formula (result in %RH), no matter which resolution is chosen:

$$RH = -6 + 125 x \frac{t_{PW}}{t_F}$$

- **Temperature conversion**

The temperature T is calculated by inserting the ratio of  $t_{PW}$  ad  $t_F$  into the following formula (result in °C), no matter which resolution is chosen:

$$Temp = -46.85 + 175.72 x \frac{t_{PW}}{t_F}$$

## APPLICATION: DEW POINT TEMPERATURE MEASUREMENT

The **dew point** is the temperature at which the water vapor in the air becomes saturated and condensation begins.

The dew point is associated with relative humidity. A high relative humidity indicates that the dew point is closer to the current air temperature. Relative humidity of 100% indicates that the dew point is equal to the current temperature (and the air is maximally saturated with water). When the dew point stays constant and temperature increases, relative humidity will decrease.

Dew point temperature of the air is calculated using Ambient Relative Humidity and Temperature measurements from HTU21P(F) sensor with following formulas given below:

### Partial Pressure ( $PP_{T_{amb}}$ ) formula from Ambient Temperature:

$$PP_{T_{amb}} = 10^{\left[ A - \frac{B}{(T_{amb} + C)} \right]}$$

### Dew point Temperature ( $T_d$ ) formula from Partial Pressure ( $PP_{T_{amb}}$ ):

$$T_d = - \left[ \frac{B}{\log_{10} \left( RH_{amb} \times \frac{PP_{T_{amb}}}{100} \right) - A} + C \right]$$

$PP_{T_{amb}}$	Partial Pressure in mmHg at ambient temperature ( $T_{amb}$ )
$RH_{amb}$	Ambient humidity in %RH, computed from HTU21P(F) sensor
$T_{amb}$	Humidity cell temperature in °C, computed from HTU21P(F) sensor
$T_d$	Calculated Dew Point in °C
A, B, C	Constants: A=8.1332; B=1762.39; C=235.66

## PACKAGE OUTLINE

- HTU21P Sensor Dimensions

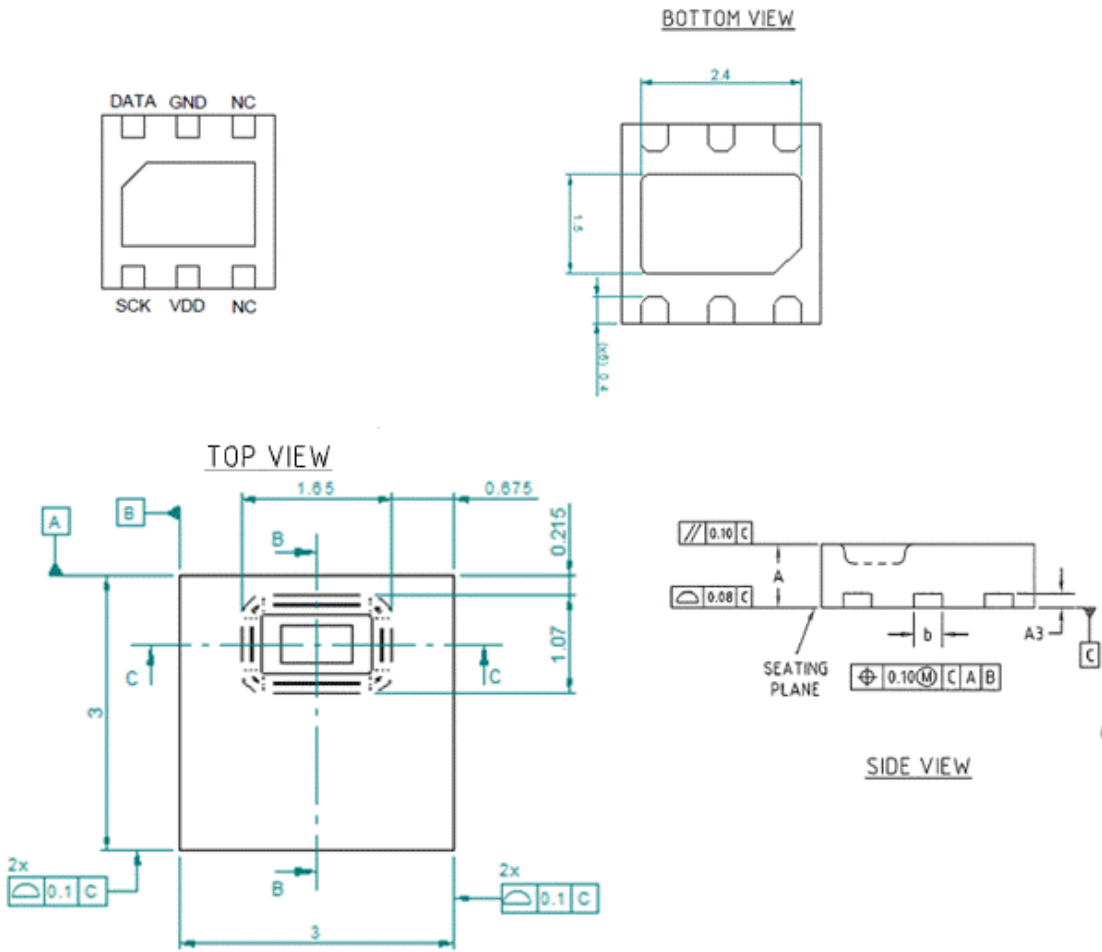

- **HTU21PF Sensor Dimensions**

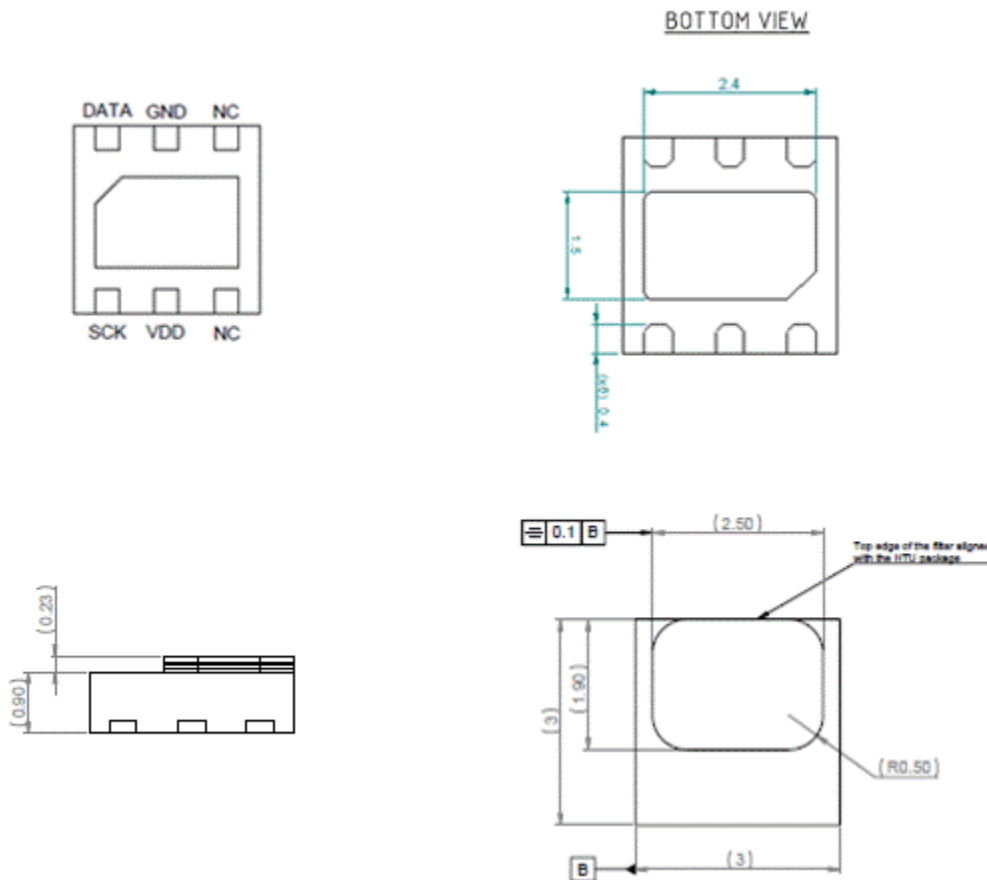

Dimensions are given in mm, tolerances are  $\pm 0.1$ mm. The die pad (thermal center pad) is internally connected to GND.

- **Packaging Type**

HTU21P(F) sensors are provided in DFN packaging. DFN stands for Dual Flat No leads.

The HTU21P(F) sensor chip is mounted to a lead frame made of Cu and plated with Ni/Pd/Au. Chip and lead frame are over molded by green epoxy-based mold compound. Please note that side walls of sensors are diced and hence lead frame at diced edge is not covered with respective protective coating.

The total weight of the sensor is 0.025g.

## HTU21P(F) RH/T SENSOR IC

Miniature Relative Humidity and Temperature

- **Traceability Information**

All HTU21P(F) sensors are laser marked with an alphanumeric, five-digit code on the sensor as pictured below.

The marking on the HTU21P(F) sensor consists of two lines with five digits each:

- The first line denotes the sensor type: HTU21.
- The second line denotes several information as:
  - The first digit of the second line defines the output mode:
    - D or A = digital and I<sup>2</sup>C
      - D :  $\pm 2\%$ RH typical /  $\pm 3\%$ RH max from 20%RH to 80%RH
      - A :  $\pm 2\%$ RH typical /  $\pm 3\%$ RH max from 15%RH to 90%RH
    - P = PWM
  - The second digit defines the manufacturing year: 3 = 2013, 4 = 2014, etc. The last three digits represent an alphanumeric tracking code. That code represents the day of the year.



Laser marking on HTU21P(F) sensor

Reels are also labeled, as displayed below and give additional traceability information.

Made in France



**measurement**  
SPECIALTIES™

---

**HPPxxxxxxx - IC 2X Humidity & Temperature**

Lot No. : 2XY(F)-TTTTTTTTT



Quantity: QQQQ 

Datecode: YYDDD

✓RoHS



With:

2X: Sensor Type (21 for HTU21P(F))  
Y: Output mode (D = Digital, P = PWM)  
(F): Sensor with PTFE membrane (only for HTU21PF)  
TTTTTTTTT: MEAS Traceability Code  
YY: Two last digits of the year  
DDD: Day of the year  
QQQQ: Quantity per reel (400, 1500 or 5000 units)

## HTU21P(F) RH/T SENSOR IC

Miniature Relative Humidity and Temperature

- **Shipping Package**

HTU21P(F) sensors are shipped in tape & reel packaging, sealed into antistatic ESD bags. Standard packaging sizes are 400, 1500 and 5000 units per reel. Each reel contains 440mm (55 pockets) header tape and 200mm (25 pockets) trailer tape. The drawing of the packaging tapes with sensor orientation is shown in the picture below.

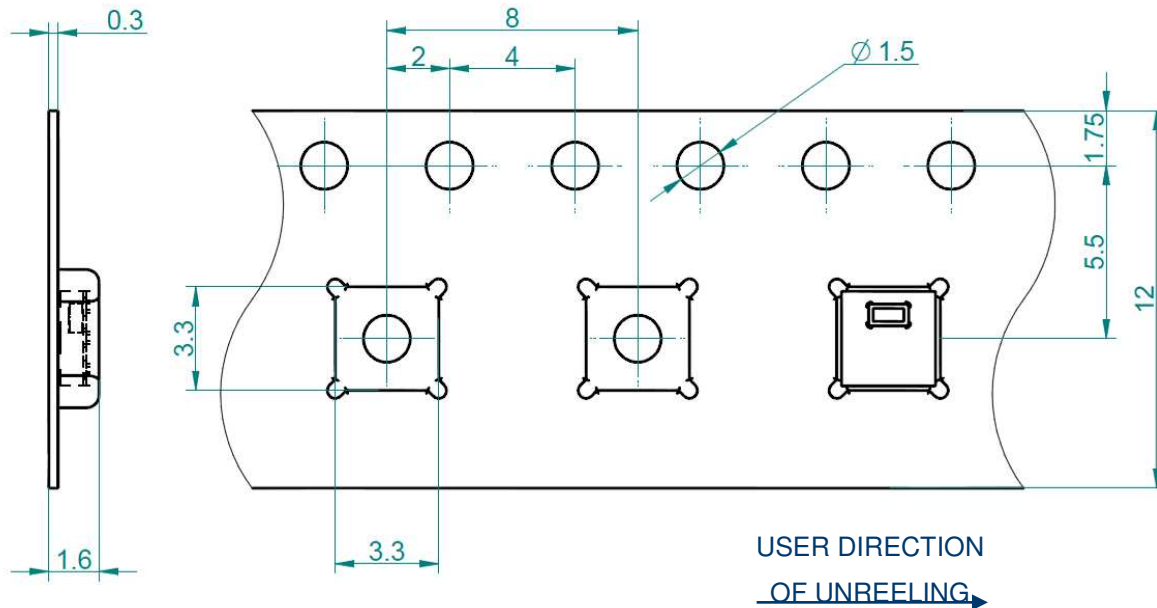

- **Packaging reels**

For 400 and 1500 units: outside diameter of 7" (178mm) and a 1/2" (13mm) diameter arbor hole.

For 5000 units: outside diameter of 13" (330mm) and a 1/2" (13mm) diameter arbor hole.

- **Handling / Storage recommendations**

In order to use and preserve the high quality performance of the HTU21 humidity and temperature sensor, the following recommendations have to be followed concerning storage and packaging. Please read the paragraph below carefully and note that all precautions are applicable for design phases, production phases as well as in case of returned material to Measurement Specialties.

When sensors are not used or assembled, we recommend to store them in their original sealed anti ESD packaging. If sensors have been removed from their original packaging, we recommend to keep them into anti static shielded ESD bags.

Such SMD type sensors that are sensitive to moisture are classified MSL level 2 according to IPC/JEDEC J-STD-020.1 for storage, packaging and handling. The shelf life is thus 1 year in following conditions of temperature and relative humidity  $\leq 30^{\circ}\text{C}$  60%RH.