

HRM SERIES RF CO-AXIAL CONNECTORS

INFORMATION

The HRM (Hirose Radio Miniature) series are connectors of the SMA (Sub-Miniature Type A) type, prescribed in MIL-C-39012. We developed them in 1967, for the first time in Japan, thanks to our company's outstanding technology. Since then, their high reliability has been recognized, and we have a sales record of more than 6 million thus far.

Uses

The HRM series is suitable for in-unit wiring in wired and wireless communications equipment, broadcasting equipment, radar equipment and electronic measuring instruments, for connections between units, and for input/output terminals of equipment components. They display their effects especially in set designs subject to severe requirements, such as those which operate in a frequency band above the L band and which also have transmission.

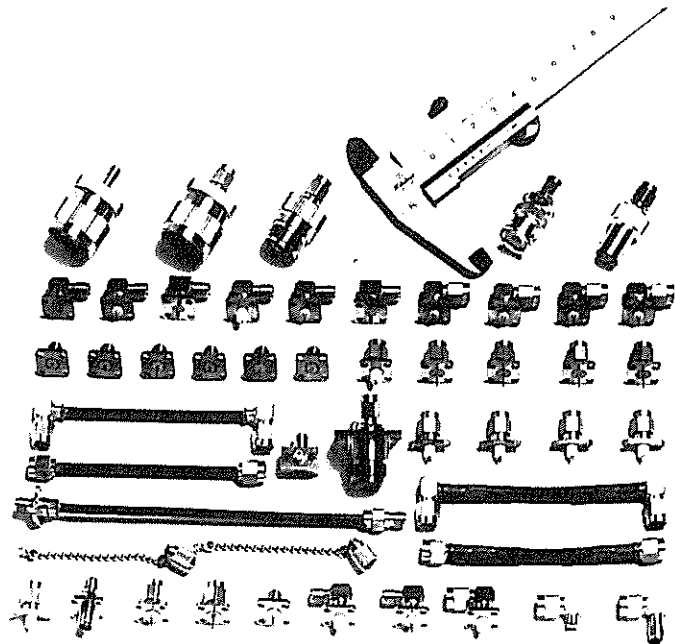

Characteristic features

1. Outstanding performance characteristics.

The matters which most require consideration in matching the impedance of coaxial connectors are these: How are we to reduce the discontinuous capacitance caused by dimensional discontinuities on the transmission channel (the differences in level provided for supporting the center contacts or the dielectric materials), and how are we to correct the discontinuous capacitance which does occur? In this respect, the high-frequency performance characteristics of the HRM series are good because there are small differences in level in the transmission channel, and the discontinuous capacitance which does occur because of the differences in level is corrected by a unique technique.

Moreover, the series also has mechanically stable performance characteristics because the center contacts and dielectric materials have secure fastening structure.

2. They are compact in size, lightweight and sturdy.

The receptacle flanges are square in shape, measuring 12.7mm on each side. Their area being about one-half that of the BNC series and about one-fourth that of the S series, they are most suitable for high-density mounting. Moreover, their weights are greatly reduced (a standard receptacle weighs only about 3 grams). Even though they are compact and lightweight, their durability is no lower than that of other types, because they use stainless-steel shells.

3. They have high quality and reliability.

The HRM series is manufactured under a system of thorough quality control from the raw materials to the shipped product. In addition to the highest manufacturing quality, they also have high reliability, and not a single faulty unit has ever occurred at the end-user stage with a service record exceeding 6 million units.

4. There are many varieties.

An extensive expansion of the varieties has been carried out recently, including providing the S type for all varieties and adding airtight connectors and connectors for .085-inch semi-rigid cables. As a result, clients can now select products more freely than was possible before.

HRM SERIES RF CO-AXIAL CONNECTORS

Standard cables

The following are the standard cables of the HRM series:

Flexible cables ——— RG-142B/U, RG-55/U

Semi-rigid cables ——— .141-inch semi-rigid cables
 (UT-141, UT-141A, UT-141AA etc.)
 ——— .085-inch semi-rigid cables (UT-85, UT-85C etc.)

The standard cable dimensions are listed on p.110.

Types

1. Classification by function

Functionally, the cables are classified into six types. The following is the configuration of their names.

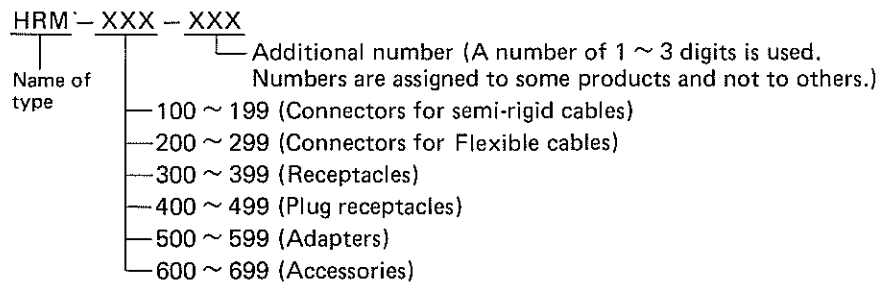

2. Classification by surface treatment

Products having the same structure, shape and dimensions may have different surface treatments of their armor (shell). There are gold-plated products (gold-plated type) and passivated products (S type).

Those of the S type have the letter S attached at the end of their part number.

Example 1 HRM-301 HRM-301S
 Gold-plated type S type

Example 2 HRM-400-12 HRM-400-12S
 Gold-plated type S type

Technical explanations of the S-type products and of passivation are given on p. 90.

3. Airtight type

Airtight products with hermetic seals are also available.

All airtight products are of the gold-plated type. Air tight types are not available in the S type. Products of the airtight type have the letter H attached at the end of their part number.

Example HRM-300-2H

HRM SERIES RF CO-AXIAL CONNECTORS

Main materials used

Parts	Materials		Finish		
	Materials	Applicable standards	Type	Plating	Plating thickness
Shell	Stainless steel	JIS G 4303	Gold-plated type	Gold plating	0.5 ~ 1 micron*
			S type	Straight type	Passivation
				L-bent type	Nickel plating
Coupling	Stainless steel	JIS G 4303	Gold-plated type	Gold plating	0.5 ~ 1 micron*
			S type	Passivation	
Female contact	Beryllium copper	JIS H 3270		Gold plating	2 ~ 3 micron
Male contact	Brass	JIS H 3250		Gold plating	2 ~ 3 microns
Solderless sleeve (ferrule)	Annealed copper	JIS H 3250		Nickel plating	3 microns
Insulation	Tetrafluoride resin				
Rubber packings	Silicone rubber				
Cord coverings	Fluoreresin				

*VA types with a plating thickness of 0.3 micron (min.) are also available.

Dimensions of coupling parts

Male coupling parts

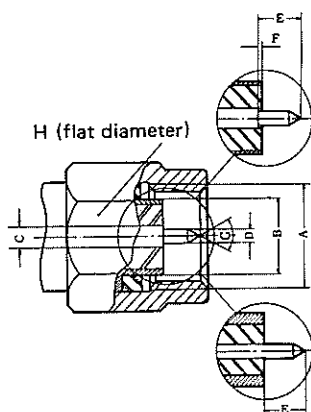

Symbols	Dimension values
A	1/4-36UNS-2B
B	4.56φ ±0.02
C	1.27φ ±0.02
D	0.92φ ^{+0.01} / _{-0.015}
E	2.3
F	0 ^{+0.15} / ₋₀
G	60°
H	8

Female coupling parts

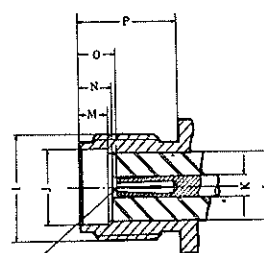

Insert pin of $0.910\phi^{+0.005}_{-0}$
Grasping force 150 grams or more

Symbols	Dimension values
I	1/4-36UNS-2A
J	4.62φ ±0.02
K	1.27φ ±0.02
L	4.11φ
M	1.93 ±0.02
N	1.93 ^{+0.05} / _{-0.1}
O	1.95 ^{+0.38} / ₋₀
P	5.8 or more

HRM SERIES RF CO-AXIAL CONNECTORS

Performance characteristics

Item		Performance characteristics	
Structural dimensions	Structure	Refer to individual drawings.	
	Dimensions	Refer to P.89 for the coupling part dimensions. Refer to P.91~107 for the external dimensions.	
Electrical characteristics	Insulation resistance	500MΩ or more measured at 500V DC	
	Withstand voltage	Test voltage 1000V AC (rms) (at normal pressure)	
	Contact resistance	Each 4mΩ or less at center contact and at out contact	
	Characteristic impedance	50Ω	
	Frequency range	DC ~ 12.4GHz (Those with a range up to 18GHz are also available. They are marked in the catalog with (18 next to the name.)	
	Voltage standing wave ratio (V.S.W.R.)	HRM-100 ~ 199	<ul style="list-style-type: none"> — Products of the straight type which have no center contacts (Example HRM-101) 1.05 + 0.01f — Products of the straight type which have center contacts (Example HRM-102) 1.05 + 0.015f (Note) — L-bent type 1.10 + 0.02f (Note) <p>Note: These values are limited to cases where .141-inch semi-rigid cables are used.</p>
		HRM-200 ~ 299	<ul style="list-style-type: none"> — Straight type (Example HRM-202) 1.10 + 0.02f — L-bent type (Example HRM-208) 1.10 + 0.025f
		HRM-300 ~ 399	<ul style="list-style-type: none"> — Straight type (Example HRM-301) 1.05 + 0.01f — L-bent type (Example HRM-305) 1.05 + 0.025f
		HRM-400 ~ 499	<ul style="list-style-type: none"> — Straight type (Example HRM-401) 1.05 + 0.01f — L-bent type (Example HRM-405) 1.05 + 0.025f
		HRM-500 ~ 599	<ul style="list-style-type: none"> — Straight type (Example HRM-513) 1.05 + 0.01f — L-bent type (Example HRM-503) 1.05 + 0.025f — Conversion adapter <ul style="list-style-type: none"> — For type N, type S (Example HRM-506) 1.05 + 0.01f — For type BNC (Example HRM-517) 1.2 or less
HRM-600 ~ 699		Standard terminal device (HRM-601, 602) 1.05 + 0.015f	
Airtight products		DC to 6GHz, .1.15 or less 6 ~ 12.4GHz, 1.2 or less f = frequency in GHz	
Mechanical characteristics	Coupling tightening torque	0.6~1.0Nm	
	Coupling fastening strength	490N or more	
	Center-contact holding power	1.5N or more	
	Center-contact fastening torque	16.7mN · m or more	
	Contact life	Contact resistance of 6 mΩ or less after 1000 insertions and withdrawals	
Environmental characteristics	Vibration resistance	*There must be no abnormalities when tested by MIL-STD-202 Method 204, test condition D.	
	Impact resistance	*There must be no abnormalities when tested by MIL-STD-202 Method 202 at an acceleration of 200G.	
	Temperature-resistance cycles	*There must be no abnormalities when tested by MIL-STD-202 Method 202, test condition C.	
	Corrosion resistance	*There must be no abnormalities when tested by MIL-STD-202 Method 101, test condition B.	
	Humidity resistance	*There must be no abnormalities when tested by MIL-STD-202 Method 106, test condition C.	
	Airtightness	1 × 10 ⁻⁷ cc/sec or less	
	Radiation resistance	There must be no abnormalities when exposed to radiation of 3 × 10 ¹³ neutrons.	

*The coupling tightening torque is 10 kg-cm.

HRM SERIES RF CO-AXIAL CONNECTORS

Plug receptacles HRM-400~499

The mounting parts of the plug receptacles are available in types for mounting strip lines (microstrips, triplates, suspender types), for mounting waveguides, etc. There are two mounting systems: fastening with machine screws (M2.3) at four or two places.

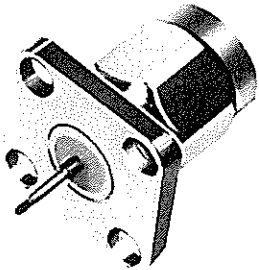

HRS No.	Part No.	
CL323-0021-9-40	HRM-401(40)	⑬
CL323-0070-4-40	HRM-401S(40)	⑬

Fastened with machine screws at four places
Round-bar terminals
Straight plug receptacles

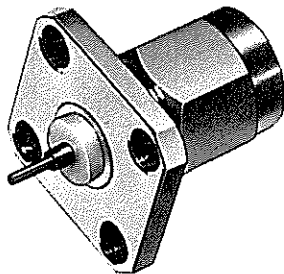
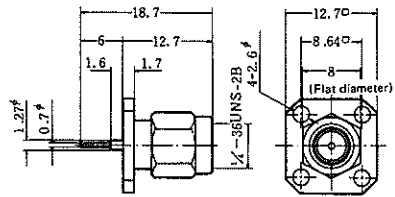

HRS No.	Part No.	
CL323-0022-1-40	HRM-402(40)	⑬
* CL323-0071-7-40	HRM-402S(40)	⑬

Fastened with machine screws at four places
Round-bar terminals
L-type plug receptacles

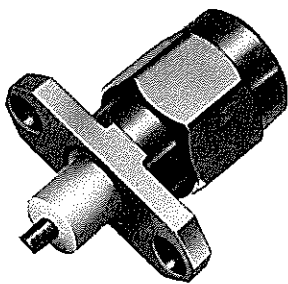
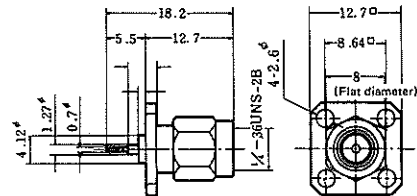

HRS No.	Part No.	
* CL323-0023-4-40	HRM-403(40)	⑬
CL323-0072-0-40	HRM-403S(40)	⑬

Fastened with machine screws at two places
Half-cutter terminals
Straight plug receptacles

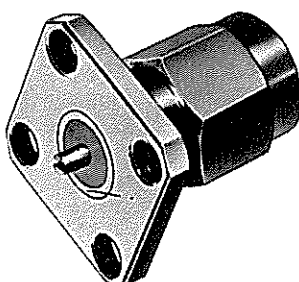
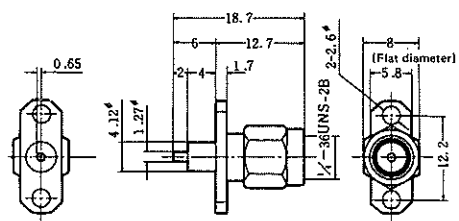

HRS No.	Part No.	
CL323-0024-7-40	HRM-404(40)	⑬
* CL323-0073-2-40	HRM-404S(40)	⑬

Fastened with machine screws at four places
Slot terminals
Straight plug receptacles

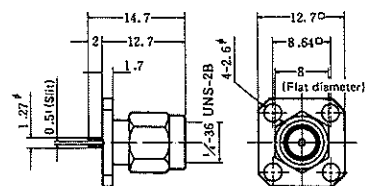

HRM SERIES

RF CO-AXIAL CONNECTORS

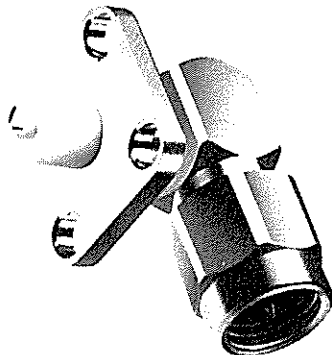

HRS No.	Part No.
CL323-0025-0-40	HRM-405(40)
CL323-0074-5-40	HRM-405S(40)

Fastened with machine screws at four places
Half-cutter terminals
L-type plug receptacles

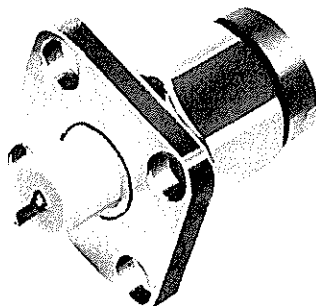
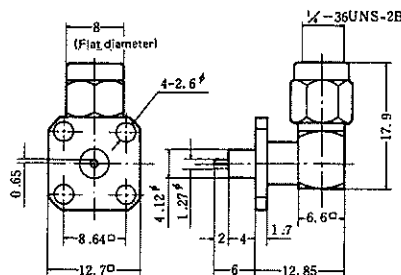

HRS No.	Part No.
CL323-0026-2-40	HRM-406(40)
CL323-0075-8-40	HRM-406S(40)

Fastened with machine screws at four places
Half-cutter terminals
Straight plug receptacles

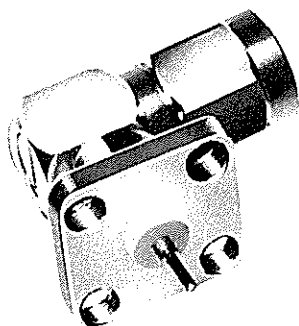
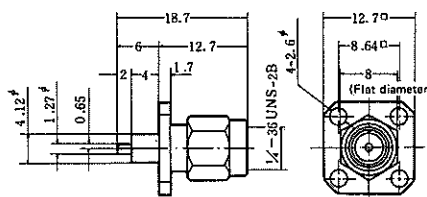

HRS No.	Part No.
CL323-0027-5-40	HRM-407(40)
CL323-0076-0-40	HRM-407S(40)

Fastened with machine screws at four places
Round-bar terminals
L-type plug receptacles

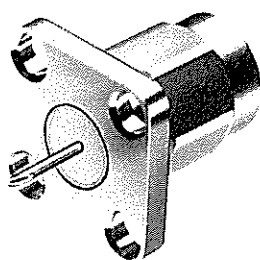
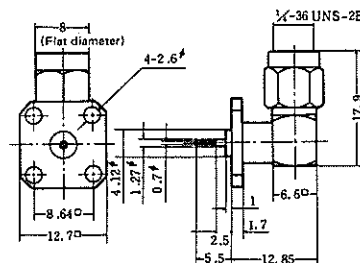

HRS No.	Part No.
CL323-0175-2	HRM-400-36S1

Fastened with machine screws at four places
Solder terminals
Straight plug receptacles

