

# BWA SERIES RF CO-AXIAL CONNECTORS

The BWA series are converter adapters used for connecting connectors of different series.

- (1) Has mating portions compatible in materials and finish with the respective series.
- (2) Conforms in performance to the lower series of the two connectors to be connected.

## Converter adapter list

Mating portion 1		Mating portion 2		Part No.	CL No.	Remarks	Shape
Series name	Mating portion	Series name	Mating portion				
N	P	BNC	P	NP-BNCP	311-0050-7		Fig.1
			J	JUG-201A/U	311-0007-8		Fig.2
		M	J	NP-MJ	311-0019-7		Fig.3
			J	N.P-S.J	311-0245-6		Fig.4
		HRM	P	HRM-555S	311-0125-4		Fig.5
			J	HRM-554S	311-0123-9		Fig.6
	J	BNC	P	UG-349/U	311-0004-0		Fig.7
				J	NJ-BNCJ	311-0005-2	
			J	NJ-BNCJ-PA	311-0014-3	Panel-mount type	Fig.9
		M	P	NJ-MP	311-0018-4		Fig.10
			J	NJ-MJ	311-0011-5		Fig.11
		TNC	P	N.J-TNC.P	311-0225-9		Fig.12
		HRM	P	HRM-553S	311-0121-3		Fig.13
				HRM-557S	311-0138-6	Panel-mount type	Fig.14
			J	HRM-552S	311-0119-1		Fig.15
				HRM-556S	311-0127-0	Panel-mount type	Fig.16
BNC	P	M	P	BNCP-MP	311-0062-6		Fig.17
			J	BNCP-MJ	311-0008-0		Fig.18
		S	P	SP-BNCP	311-0055-0		Fig.19
			J	SJ-BNCP	311-0060-0		Fig.20
		UM	J	BNCP-UMJ	311-0065-4		Fig.21
		MSS	P	BNCP-MSSP	311-0107-2		Fig.22
			J	BNCP-MSSJ	311-0082-3		Fig.23
	HRM	P	HRM-519(09)	311-0101-6-09		Fig.24	
		J	HRM-518(09)	311-0100-3-09		Fig.25	
	J	UHF	P	UG-273/U	311-0003-7		Fig.26
		M	P	BNCJ-MP	311-0009-3		Fig.27
			J	MJ-BNCJ	311-0020-6		Fig.28
		S	P	SP-BNCJ	311-0058-9		Fig.29
			J	SJ-BNCJ	311-0054-8		Fig.30
				SJ-BNCJ-PA	311-0108-5	Panel-mount type	Fig.31
		TNC	J	BNC.J-TNC.J	311-0194-7		Fig.32
		UM	P	BNCJ-UMP	311-0052-2		Fig.33
J			BNCJ-UMJ	311-0053-5		Fig.34	
		J	BNCJ-UMJ-PA(04)	311-0103-1-04	Panel-mount type	Fig.35	
MSS	P	BNCJ-MSSP	311-0081-0		Fig.36		
	J	BNCJ-MSSJ	311-0066-7		Fig.37		

# BWA SERIES RF CO-AXIAL CONNECTORS

Mating portion 1		Mating portion 2		Part No.	CL No.	Remarks	Shape		
Series name	Mating portion	Series name	Mating portion						
BNC	J	HRM	P	HRM-517(09)	311-0099-6-09		Fig.38		
			J	HRM-516(09)	311-0102-9-09		Fig.39		
		POD	P	BNCJ-PODP	311-0160-5		Fig.40		
			J	BNCJ-PODJ	311-0161-8		Fig.41		
		PO6	J	BNCJ-PO6J	311-0167-4		Fig.42		
S	P	HRM	P	HRM-509(09)	311-0093-0-09		Fig.43		
			J	HRM-508(09)	311-0092-7-09		Fig.44		
	J	HRM	P	HRM-507(09)	311-0091-4-09		Fig.45		
				HRM-512(09)	311-0098-3-09	Panel-mount type	Fig.46		
			HRM-512S	311-0144-9	Panel-mount type, S type	Fig.46			
			HRM-506(09)	311-0090-1-09		Fig.47			
			J	HRM-511(09)	311-0094-2-09	Panel-mount type	Fig.48		
			HRM-511S	311-0143-6	Panel-mount type, S type	Fig.48			
TNC	J	HRM	J	HRMJ-TNCJ-PA	311-0202-3	Panel-mount type	Fig.49		
UM	P	HRM	J	UM.P-HRM.J	311-0176-5		Fig.50		
	J	HRM	J	HRMJ-UMJ	311-0164-6		Fig.51		
HRM	P	POB	P	HRMP-POBP-1	311-0169-0		Fig.52		
			J	HRMP-POBJ	311-0152-7		Fig.53		
		POD	J	HRM.P-POD.J	311-0177-8		Fig.54		
		POD1	J	HRMP-POD1J	311-0253-4		Fig.55		
		PO6	J	HRMP-PO6J	311-0172-4		Fig.56		
		S.FLSFL2	J	HRMP-S.FLJ-2	311-0249-7	For inspecting harnessed parts	Fig.57		
		H.FL	J	HRMP-H.FLJ	311-0232-4	For inspecting harnessed parts	Fig.58		
		HRMM	P	HRMP-HRMMP	311-0250-6		Fig.59		
			J	HRMP-HRMMJ	311-0243-0		Fig.60		
					J	HRMP-HRMMJ-LA	311-0226-1		Fig.61
		J	POB	P	HRMJ-POBP	311-0151-4		Fig.62	
	HRMJ-POBP-PA				311-0206-4		Fig.63		
	J		HRMJ-POBJ	311-0149-2		Fig.64			
			HRMJ-POBJ-PA	311-0150-1		Fig.65			
	POD		P	HRMJ-PODP	311-0157-0		Fig.66		
	POD1		P	HRMJ-POD1P-1	311-0254-7		Fig.67		
	PO6		P	HRMJ-PO6P	311-0173-7		Fig.68		
	PO51		P	HRMJ-PO51P	311-0231-1		Fig.69		
	FL		P	HRMJ-FLP-1	311-0195-0		Fig.70		
			J	HRMJ-FLJ	311-0179-3		Fig.71		
	S.FLSFL2		P	HRMJ-S.FLP	311-0218-3		Fig.72		
	H.FL		P	HRMJ-H.FLP-3	311-0264-0		Fig.73		
	HRMM	P	HRMJ-HRMMP-2	311-0221-8		Fig.74			
HRMJ-HRMMP-LA			311-0227-4		Fig.75				
	J	HRMJ-HRMMJ	311-0220-5		Fig.76				

Note 1. Part No. NP-BNCP of Fig.1 is shown that series name N, coupling part p (plug) for connecting part 1 and series name BNC, coupling part P (plug) for connecting part 2.

2. Series name of each connecting parts are shown in order to HIROSE's CL numbers.

# BWA SERIES RF CO-AXIAL CONNECTORS

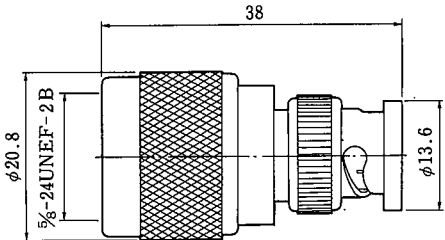
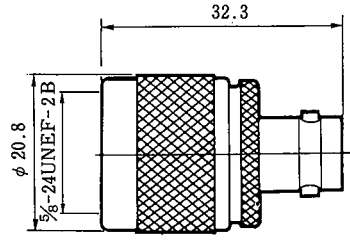
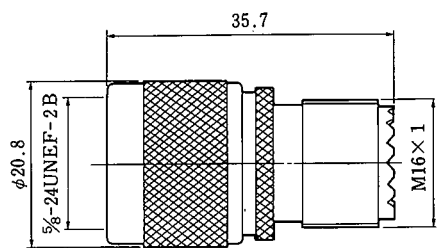
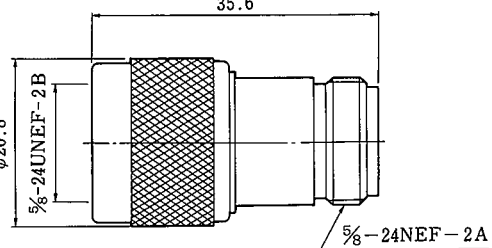
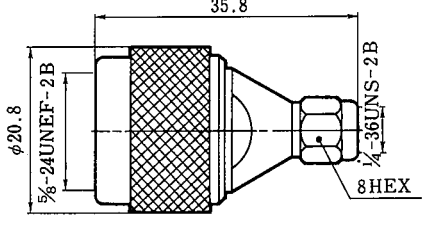
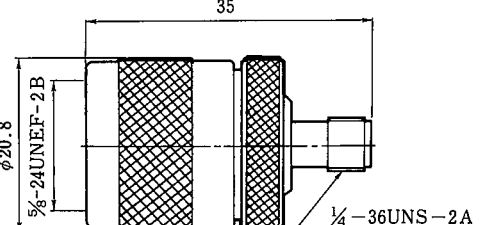
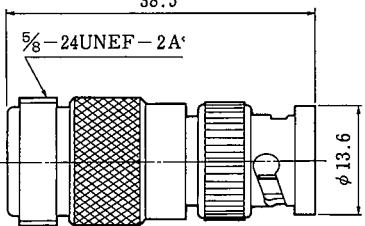
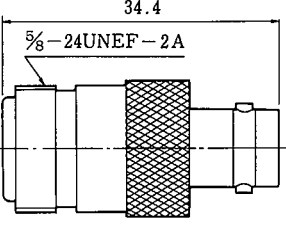
<p>Fig.1</p>  <p>NP-BNCP CL311-0050-7</p>	<p>Fig.2</p>  <p>UG-201A/U CL311-0007-8</p>
<p>Fig.3</p>  <p>NP-MJ CL311-0019-7</p>	<p>Fig.4</p>  <p>N.P-S.J CL311-0245-6</p>
<p>Fig.5</p>  <p>HRM-555S CL311-0125-4</p>	<p>Fig.6</p>  <p>HRM-554S CL311-0123-9</p>
<p>Fig.7</p>  <p>UG-349/U CL311-0004-0</p>	<p>Fig.8</p>  <p>NJ-BNCJ CL311-0005-2</p>

# BWA SERIES RF CO-AXIAL CONNECTORS

Fig.9

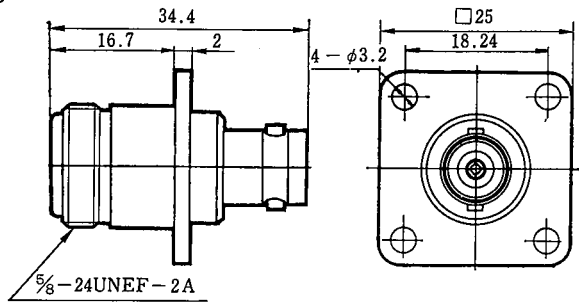

NJ-BNCJ-PA  
CL311-0014-3

Fig.10

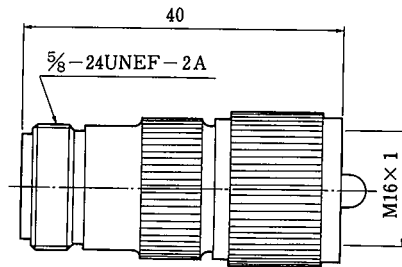

NJ-MP  
CL311-0018-4

Fig.11

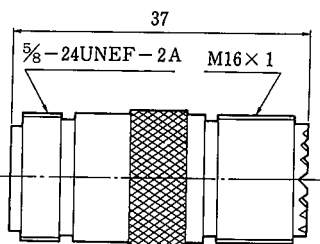

NJ-MJ  
CL311-0011-5

Fig.12

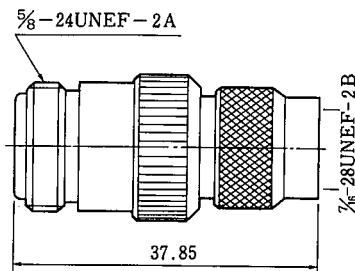

N.J-TNC.P  
CL311-0225-9

Fig.13

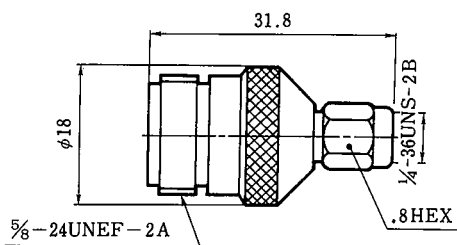

HRM-553S  
CL311-0121-3

Fig.14

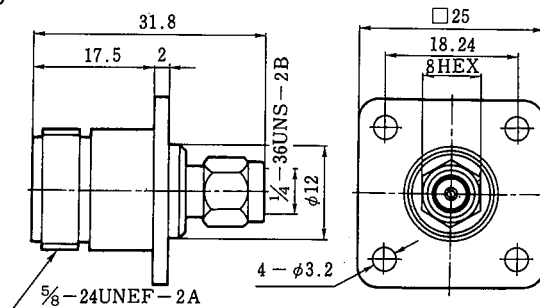

HRM-557S  
CL311-0138-6

Fig.15

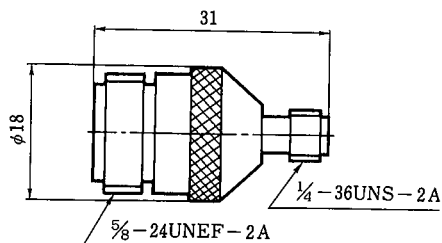

HRM-552S  
CL311-0119-1

Fig.16

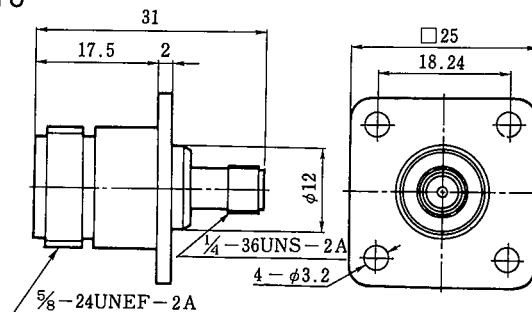

HRM-556S  
CL311-0127-0

# BWA SERIES RF CO-AXIAL CONNECTORS

Fig.17

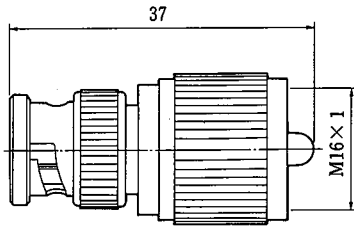

BNCP-MP  
CL311-0062-6

Fig.18

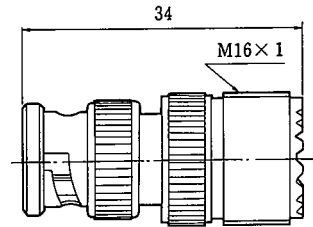

BNCP-MJ  
CL311-0008-0

Fig.19

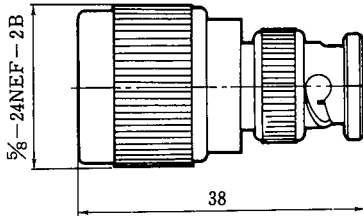

SP-BNCP  
CL311-0055-0

Fig.20

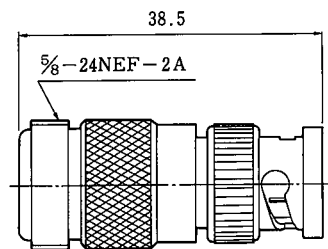

SJ-BNCP  
CL311-0060-0

Fig.21

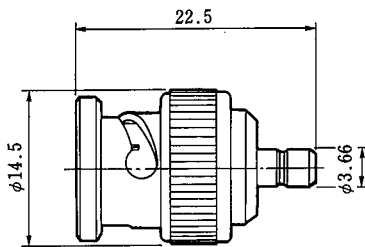

BNCP-UMJ  
CL311-0065-4

Fig.22

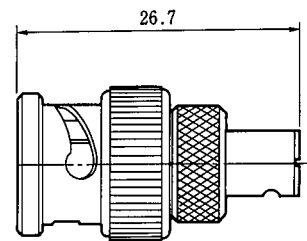

BNCP-MSSP  
CL311-0107-2

Fig.23

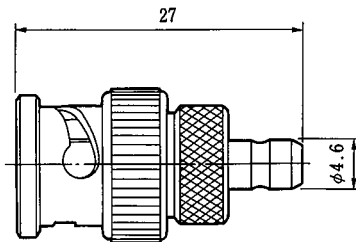

BNCP-MSSJ  
CL311-0082-3

Fig.24

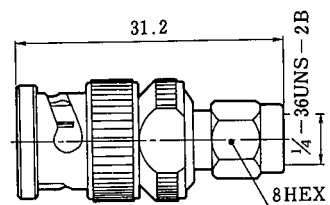

HRM-519(09)  
CL311-0101-6-09

# BWA SERIES RF CO-AXIAL CONNECTORS

Fig.25

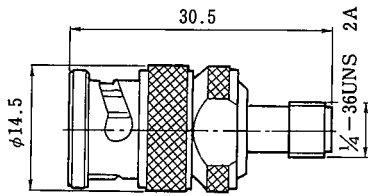

HRM-518(09)  
CL311-0100-3-09

Fig.26

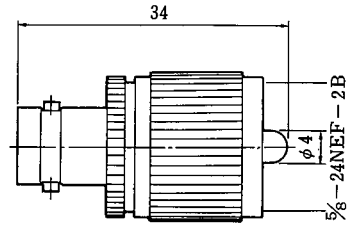

UG-273/U  
CL311-0003-7

Fig.27

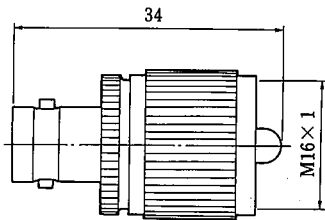

BNCJ-MP  
CL311-0009-3

Fig.28

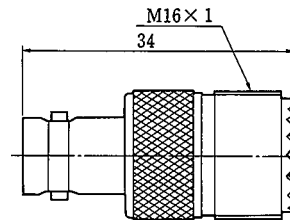

MJ-BNCJ  
CL311-0020-6

Fig.29

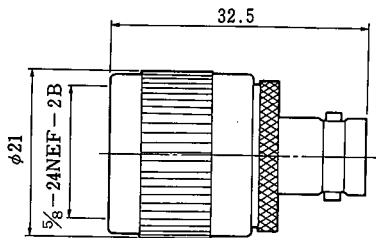

SP-BNCJ  
CL311-0058-9

Fig.30

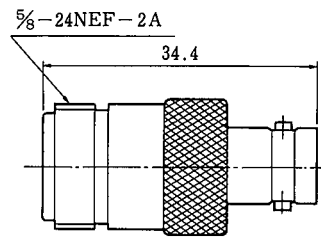

SJ-BNCJ  
CL311-0054-8

Fig.31

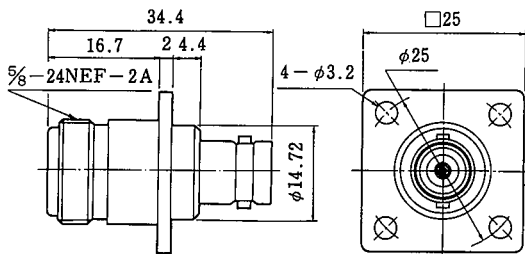

SJ-BNCJ-PA  
CL311-0108-5

Fig.32

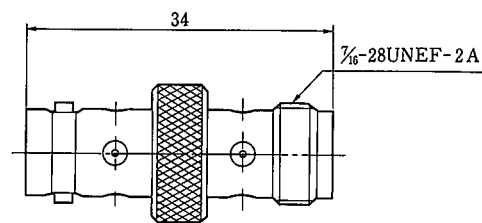

BNC.J-TNC.J  
CL311-0194-7

# BWA SERIES RF CO-AXIAL CONNECTORS

Fig.33

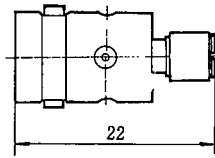

BNCJ-UMP  
CL311-0052-2

Fig.34

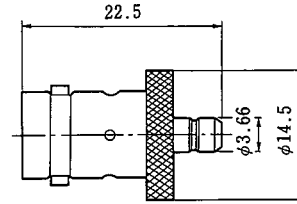

BNCJ-UMJ  
CL311-0053-5

Fig.35

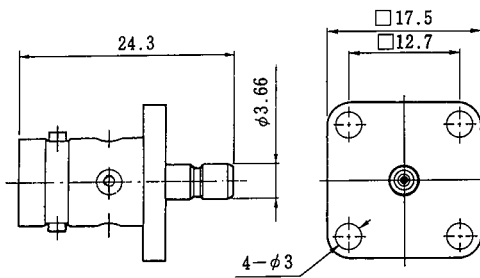

BNCJ-UMJ-PA (04)  
CL311-0103-1-04

Fig.36

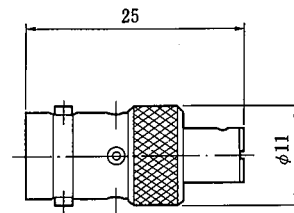

BNCJ-MSSP  
CL311-0081-0

Fig.37

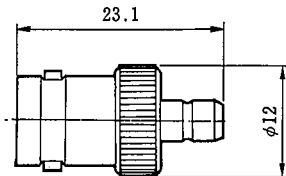

BNCJ-MSSJ  
CL311-0066-7

Fig.38

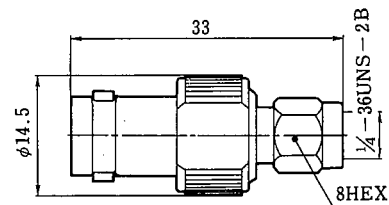

HRM-517 (09)  
CL311-0099-6-09

Fig.39

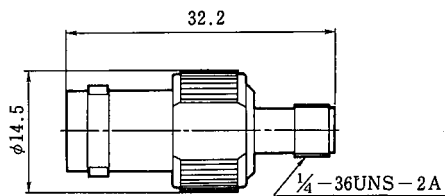

HRM-516 (09)  
CL311-0102-9-09

Fig.40

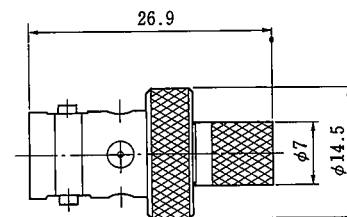

BNCJ-PODP  
CL311-0160-5

# BWA SERIES RF CO-AXIAL CONNECTORS

Fig.41

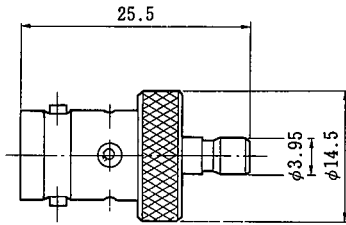

BNCJ-PODJ  
CL311-0161-8

Fig.42

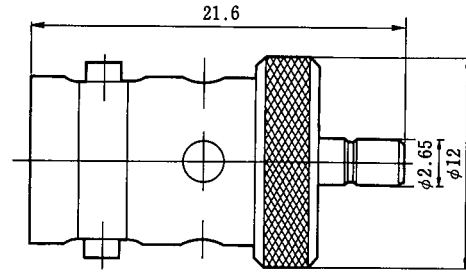

BNCJ-PO6J  
CL311-0167-4

Fig.43

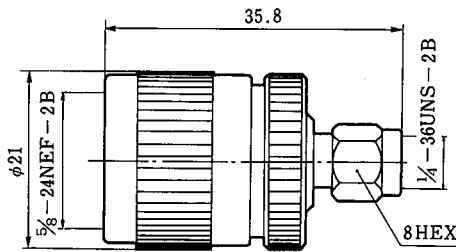

HRM-509 (09)  
CL311-0093-0-09

Fig.44

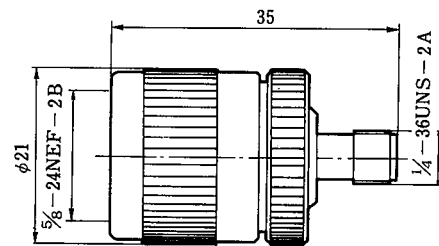

HRM-508 (09)  
CL311-0092-7-09

Fig.45

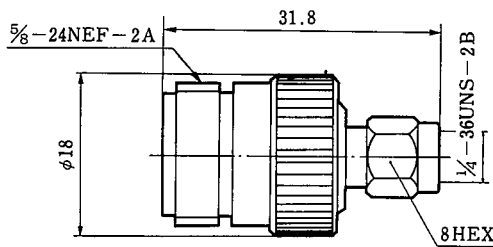

HRM-507 (09)  
CL311-0091-4-09

Fig.46

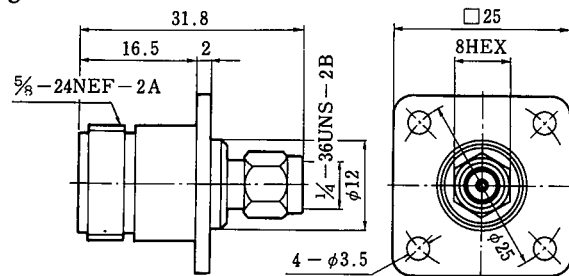

HRM-512 (09)      HRM-512S  
CL311-0098-3-09      CL311-0144-9

Fig.47

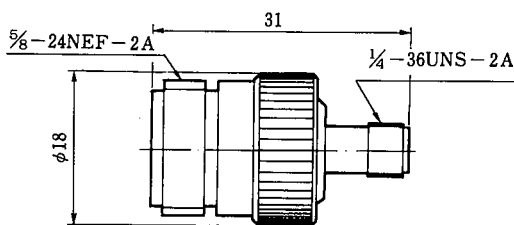

HRM-506 (09)  
CL311-0090-1-09

Fig.48

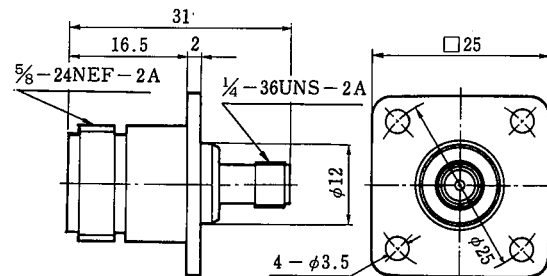

HRM-511 (09)      HRM-511S  
CL311-0094-2-09      CL311-0143-6



# BWA SERIES RF CO-AXIAL CONNECTORS

Fig.49

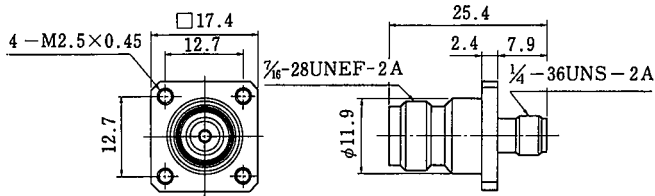

HRMJ-TNCJ-PA  
CL311-0202-3

Fig.50

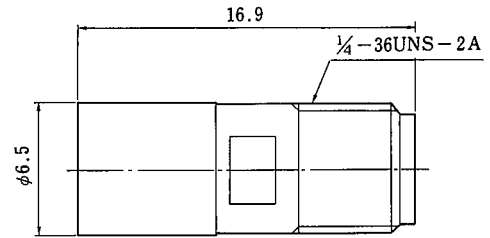

UM.P-HRM.J  
CL311-0176-5

Fig.51

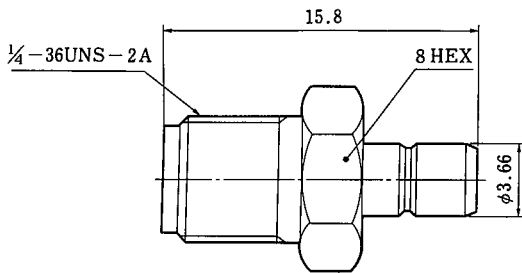

HRMJ-UMJ  
CL311-0164-6

Fig.52

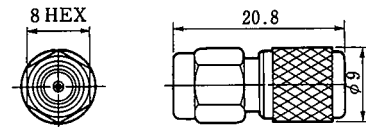

HRMP-POBP-1  
CL311-0169-0

Fig.53

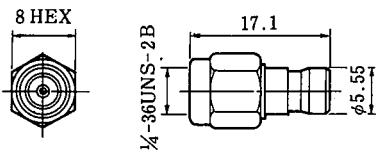

HRMP-POBJ  
CL311-0152-7

Fig.54

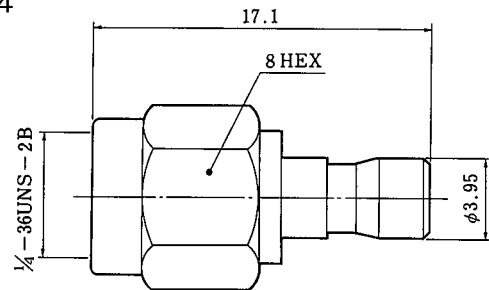

HRM.P-POD.J  
CL311-0177-8

Fig.55

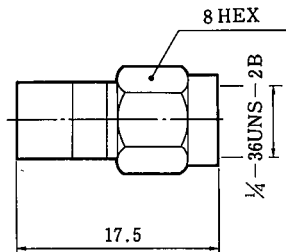

HRMP-POD1J  
CL311-0253-4

Fig.56

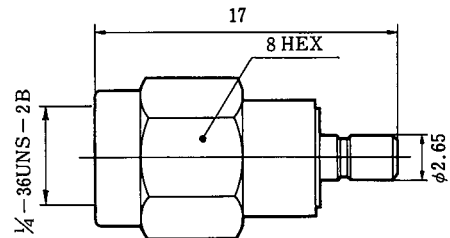

HRMP-PO6J  
CL311-0172-4

# BWA SERIES RF CO-AXIAL CONNECTORS

Fig.57

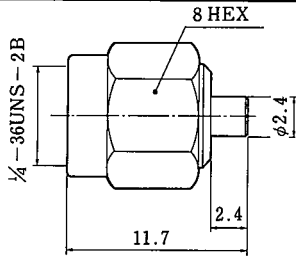

Note : The mating portion on the S. FL side mates with the S. FL and S. FL2 plugs.  
 Having no locking mechanism, however, the S. FL side mating portion can be used only for performance measurement.

HRMP-S.FLJ-2  
 CL311-0249-7

Fig.58

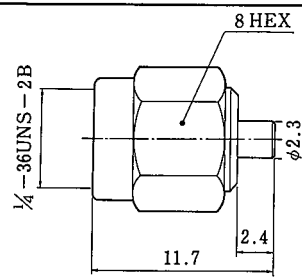

Note : Having no locking mechanism, however, the S. FL side mating portion can be used only for performance measurement.

HRMP-H.FLJ  
 CL311-0232-4

Fig.59

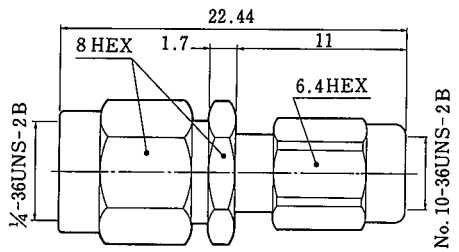

HRMP-HRMMP  
 CL311-0250-6

Fig.60

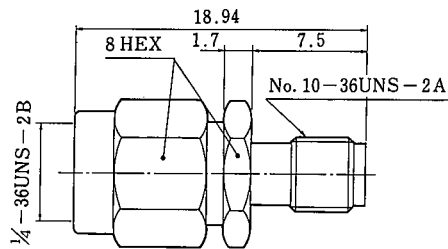

HRMP-HRMMJ  
 CL311-0243-0

Fig.61

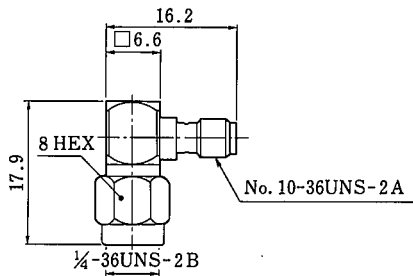

HRMP-HRMMJ-LA  
 CL311-0226-1

Fig.62

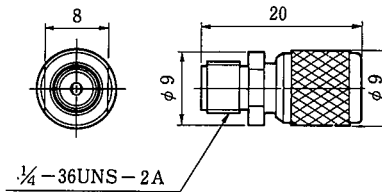

HRMJ-POBP  
 CL311-0151-4

Fig.63

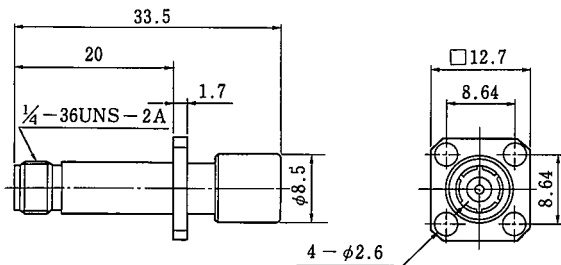

HRMJ-POBP-PA  
 CL311-0206-4

Fig.64

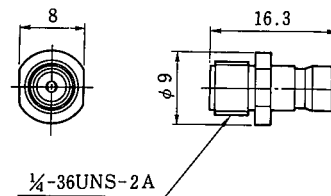

HRMJ-POBJ  
 CL311-0149-2

# BWA SERIES RF CO-AXIAL CONNECTORS

Fig.65

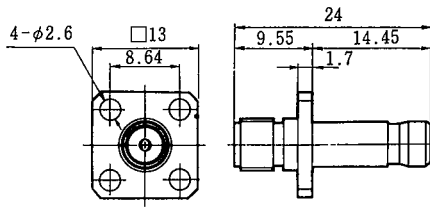

HRMJ-POBJ-PA  
CL311-0150-1

Fig.66

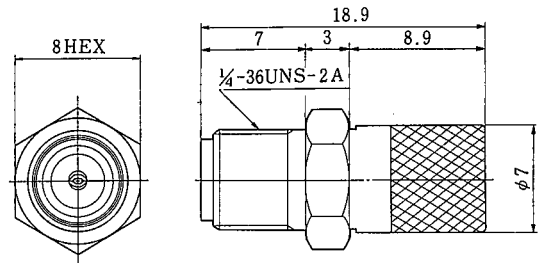

HRMJ-PODP  
CL311-0157-0

Fig.67

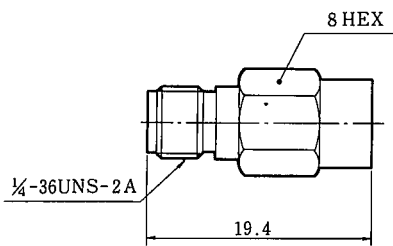

HRMJ-POD1P-1  
CL311-0254-7

Fig.68

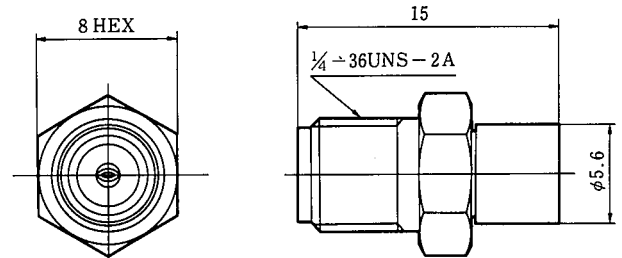

HRMJ-PO6P  
CL311-0173-7

Fig.69

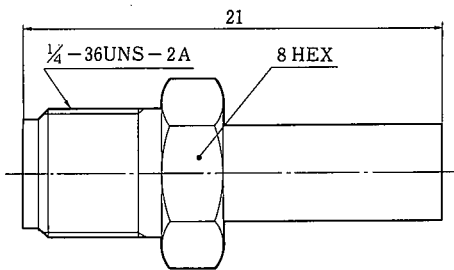

HRMJ-PO51P  
CL311-0231-1

Fig.70

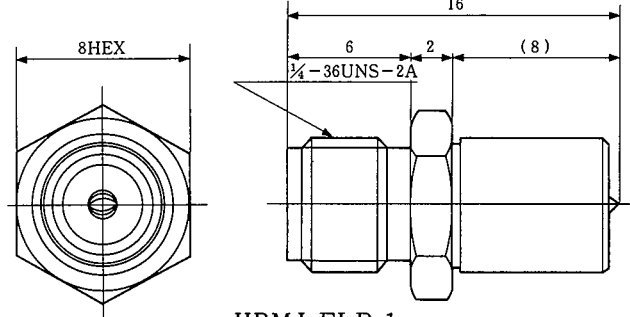

HRMJ-FLP-1  
CL311-0195-0

Fig.71

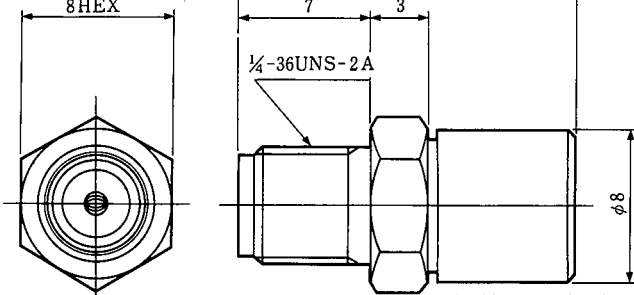

HRMJ-FLJ  
CL311-0179-3

Note: Having no locking mechanism, however, the FL side mating portion can be used only for performance measurement.

Fig.72

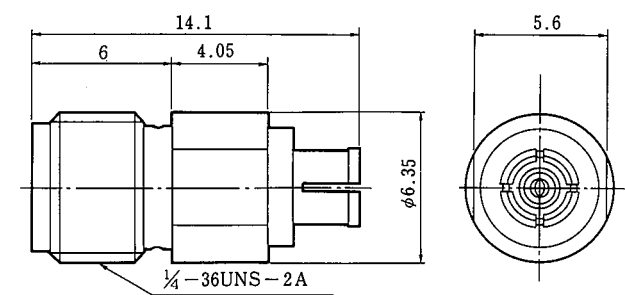

HRMJ-S.FLP  
CL311-0218-3

Note: Compatible with S. FL and S. FL2.