

HRM SERIES RF CO-AXIAL CONNECTORS

INFORMATION

The HRM (Hirose Radio Miniature) series are connectors of the SMA (Sub-Miniature Type A) type, prescribed in MIL-C-39012. We developed them in 1967, for the first time in Japan, thanks to our company's outstanding technology. Since then, their high reliability has been recognized, and we have a sales record of more than 6 million thus far.

Uses

The HRM series is suitable for in-unit wiring in wired and wireless communications equipment, broadcasting equipment, radar equipment and electronic measuring instruments, for connections between units, and for input/output terminals of equipment components. They display their effects especially in set designs subject to severe requirements, such as those which operate in a frequency band above the L band and which also have transmission.



Characteristic features

1. Outstanding performance characteristics.

The matters which most require consideration in matching the impedance of coaxial connectors are these: How are we to reduce the discontinuous capacitance caused by dimensional discontinuities on the transmission channel (the differences in level provided for supporting the center contacts or the dielectric materials), and how are we to correct the discontinuous capacitance which does occur? In this respect, the high-frequency performance characteristics of the HRM series are good because there are small differences in level in the transmission channel, and the discontinuous capacitance which does occur because of the differences in level is corrected by a unique technique.

Moreover, the series also has mechanically stable performance characteristics because the center contacts and dielectric materials have secure fastening structure.

2. They are compact in size, lightweight and sturdy.

The receptacle flanges are square in shape, measuring 12.7mm on each side. Their area being about one-half that of the BNC series and about one-fourth that of the S series, they are most suitable for high-density mounting. Moreover, their weights are greatly reduced (a standard receptacle weighs only about 3 grams). Even though they are compact and lightweight, their durability is no lower than that of other types, because they use stainless-steel shells.

3. They have high quality and reliability.

The HRM series is manufactured under a system of thorough quality control from the raw materials to the shipped product. In addition to the highest manufacturing quality, they also have high reliability, and not a single faulty unit has ever occurred at the end-user stage with a service record exceeding 6 million units.

4. There are many varieties.

An extensive expansion of the varieties has been carried out recently, including providing the S type for all varieties and adding airtight connectors and connectors for .085-inch semi-rigid cables. As a result, clients can now select products more freely than was possible before.

HRM SERIES RF CO-AXIAL CONNECTORS

Standard cables

The following are the standard cables of the HRM series:

Flexible cables ——— RG-142B/U, RG-55/U

Semi-rigid cables ——— .141-inch semi-rigid cables
 (UT-141, UT-141A, UT-141AA etc.)
 ——— .085-inch semi-rigid cables (UT-85, UT-85C etc.)

The standard cable dimensions are listed on p.110.

Types

1. Classification by function

Functionally, the cables are classified into six types. The following is the configuration of their names.

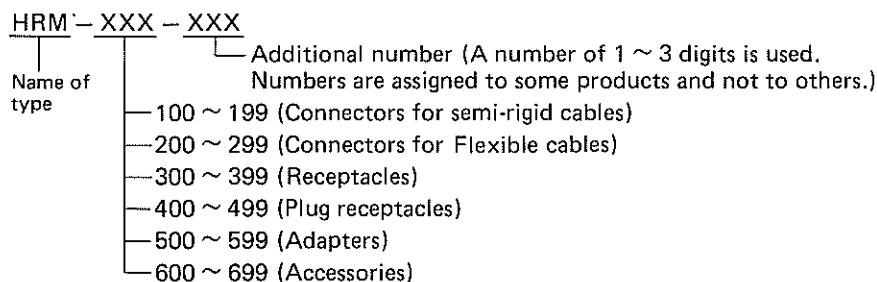

2. Classification by surface treatment

Products having the same structure, shape and dimensions may have different surface treatments of their armor (shell). There are gold-plated products (gold-plated type) and passivated products (S type).

Those of the S type have the letter S attached at the end of their part number.

Example 1 HRM-301 HRM-301S
 Gold-plated type S type

Example 2 HRM-400-12 HRM-400-12S
 Gold-plated type S type

Technical explanations of the S-type products and of passivation are given on p. 90.

3. Airtight type

Airtight products with hermetic seals are also available.

All airtight products are of the gold-plated type. Air tight types are not available in the S type. Products of the airtight type have the letter H attached at the end of their part number.

Example HRM-300-2H

HRM SERIES RF CO-AXIAL CONNECTORS

Main materials used

Parts	Materials		Finish		
	Materials	Applicable standards	Type	Plating	Plating thickness
Shell	Stainless steel	JIS G 4303	Gold-plated type	Gold plating	0.5 ~ 1 micron*
			S type	Straight type	Passivation
				L-bent type	Nickel plating
Coupling	Stainless steel	JIS G 4303	Gold-plated type	Gold plating	0.5 ~ 1 micron*
			S type	Passivation	
Female contact	Beryllium copper	JIS H 3270		Gold plating	2 ~ 3 micron
Male contact	Brass	JIS H 3250		Gold plating	2 ~ 3 microns
Solderless sleeve (ferrule)	Annealed copper	JIS H 3250		Nickel plating	3 microns
Insulation	Tetrafluoride resin				
Rubber packings	Silicone rubber				
Cord coverings	Fluoreresin				

*VA types with a plating thickness of 0.3 micron (min.) are also available.

Dimensions of coupling parts

Male coupling parts



Symbols	Dimension values
A	¼-36UNS-2B
B	4.56φ ±0.02
C	1.27φ ±0.02
D	0.92φ ^{+0.01} / _{-0.015}
E	2.3
F	0 ^{+0.15} / ₋₀
G	60°
H	8

Female coupling parts



Insert pin of 0.910φ ^{+0.005}/₋₀
Grasping force 150 grams or more

Symbols	Dimension values
I	¼-36UNS-2A
J	4.62φ ±0.02
K	1.27φ ±0.02
L	4.11φ
M	1.93 ±0.02
N	1.93 ^{+0.05} / _{-0.1}
O	1.95 ^{+0.38} / ₋₀
P	5.8 or more

HRM SERIES RF CO-AXIAL CONNECTORS

Performance characteristics

Item		Performance characteristics	
Structural dimensions	Structure	Refer to individual drawings.	
	Dimensions	Refer to P.89 for the coupling part dimensions. Refer to P.91~107 for the external dimensions.	
Electrical characteristics	Insulation resistance	500MΩ or more measured at 500V DC	
	Withstand voltage	Test voltage 1000V AC (rms) (at normal pressure)	
	Contact resistance	Each 4mΩ or less at center contact and at out contact	
	Characteristic impedance	50Ω	
	Frequency range	DC ~ 12.4GHz (Those with a range up to 18GHz are also available. They are marked in the catalog with (18 next to the name.)	
	Voltage standing wave ratio (V.S.W.R.)	HRM-100 ~ 199	<ul style="list-style-type: none"> — Products of the straight type which have no center contacts (Example HRM-101) 1.05 + 0.01f — Products of the straight type which have center contacts (Example HRM-102) 1.05 + 0.015f (Note) — L-bent type 1.10 + 0.02f (Note) <p>Note: These values are limited to cases where .141-inch semi-rigid cables are used.</p>
		HRM-200 ~ 299	<ul style="list-style-type: none"> — Straight type (Example HRM-202) 1.10 + 0.02f — L-bent type (Example HRM-208) 1.10 + 0.025f
		HRM-300 ~ 399	<ul style="list-style-type: none"> — Straight type (Example HRM-301) 1.05 + 0.01f — L-bent type (Example HRM-305) 1.05 + 0.025f
		HRM-400 ~ 499	<ul style="list-style-type: none"> — Straight type (Example HRM-401) 1.05 + 0.01f — L-bent type (Example HRM-405) 1.05 + 0.025f
		HRM-500 ~ 599	<ul style="list-style-type: none"> — Straight type (Example HRM-513) 1.05 + 0.01f — L-bent type (Example HRM-503) 1.05 + 0.025f — Conversion adapter <ul style="list-style-type: none"> — For type N, type S (Example HRM-506) 1.05 + 0.01f — For type BNC (Example HRM-517) 1.2 or less
HRM-600 ~ 699		Standard terminal device (HRM-601, 602) 1.05 + 0.015f	
Airtight products		DC to 6GHz, .1.15 or less 6 ~ 12.4GHz, 1.2 or less f = frequency in GHz	
Mechanical characteristics	Coupling tightening torque	0.6~1.0Nm	
	Coupling fastening strength	490N or more	
	Center-contact holding power	1.5N or more	
	Center-contact fastening torque	16.7mN · m or more	
	Contact life	Contact resistance of 6 mΩ or less after 1000 insertions and withdrawals	
Environmental characteristics	Vibration resistance	*There must be no abnormalities when tested by MIL-STD-202 Method 204, test condition D.	
	Impact resistance	*There must be no abnormalities when tested by MIL-STD-202 Method 202 at an acceleration of 200G.	
	Temperature-resistance cycles	*There must be no abnormalities when tested by MIL-STD-202 Method 202, test condition C.	
	Corrosion resistance	*There must be no abnormalities when tested by MIL-STD-202 Method 101, test condition B.	
	Humidity resistance	*There must be no abnormalities when tested by MIL-STD-202 Method 106, test condition C.	
	Airtightness	1 × 10 ⁻⁷ cc/sec or less	
	Radiation resistance	There must be no abnormalities when exposed to radiation of 3 × 10 ¹³ neutrons.	

*The coupling tightening torque is 10 kg-cm.

HRM SERIES RF CO-AXIAL CONNECTORS

Guide to products

The following are typical products of the HRM series. Various products other than those listed here are also available. Please inquire about them.

Connectors for semi-rigid cables HRM-100~199

Connectors for semi-rigid cables match two types of cables: .141-inch and .085-inch semi-rigid cables. Use the .141-inch cables in order to obtain the V.S.W.R. listed on P.90. The .085-inch cables, which have good flexibility, are suitable when high-density wiring is to be used inside the set. In this case, the V.S.W.R. value will be higher than with the .141-inch cables.

▲For .141-inch Semi-rigid cable

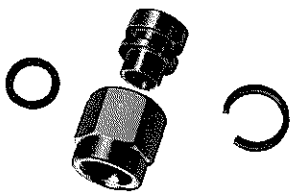

HRS No.	Part No.	
* CL323-0001-1-09	HRM-101(09)	Ⓢ
* CL323-0153-0-09	*HRM-101S(09)	Ⓢ

Plugs for .141-inch semi-rigid cables

*The shells are gold-plated, and the couplings are passivated.

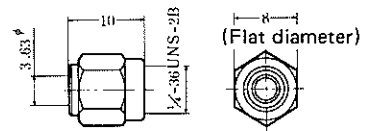

HRS No.	Part No.
CL323-0002-4-09	HRM-102(09)
CL323-0359-5	**HRM-102-1
CL323-0131-7-09	* HRM-102S(09)
CL323-0360-4	***HRM-102S-1

Jack for .141-inch semi-rigid cable

* Shell is passivated treatment, coupling is gold plated.
 ** Solderless center termination type.

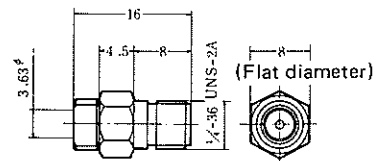

*Standard product

HRM SERIES RF CO-AXIAL CONNECTORS

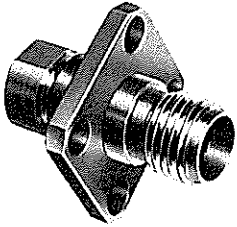

HRS No.	Part No.
CL323-0003-7-09	HRM-103(09)
CL323-0361-7	** HRM-103-1
CL323-0141-0-09	* HRM-103S(09)
CL323-0362-0	***HRM-103S-1

Jack for .141-inch semi-rigid cable

- * Shell is passivated treatment, coupling is gold plated.
- ** Solderless center termination type.

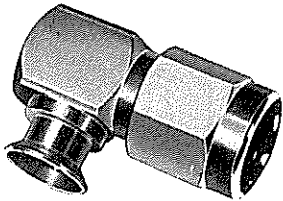
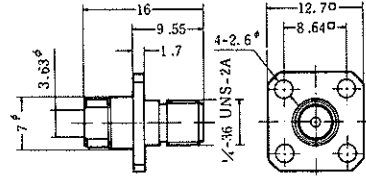

HRS No.	Part No.
* CL323-0004-0-40	HRM-104(40)
* CL323-0122-6-40	HRM-104S(40)

L-type plugs for .141-inch semi-rigid cables

- * The shells are gold-plated, and the couplings are passivated.

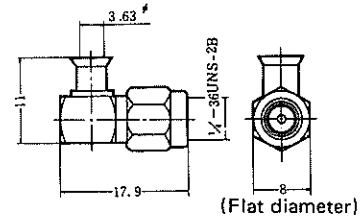

For .085-inch Semi-rigid cable

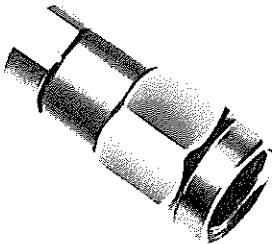

HRS No.	Part No.
CL323-0142-3-40	HRM-100-1(40)
* CL323-0125-4-40	HRM-100-1S(40)

Plugs for .085-inch semi-rigid cables

- * The shells and couplings are passivated, and the tightening fixtures are gold-plated.

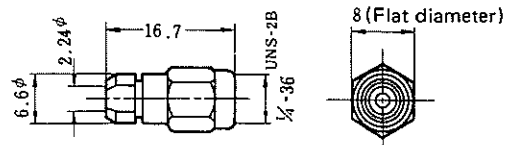

HRM SERIES RF CO-AXIAL CONNECTORS

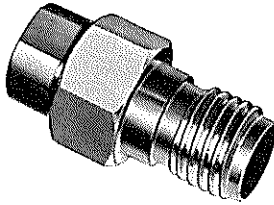

HRS No.	Part No.
CL323-0143-6-09	HRM-100-2(09)
CL323-0144-9-09	*HRM-100-2S(09)

Jacks for .085-inch semi-rigid cables

* The shells are passivated and tightening fixtures are gold-plated.

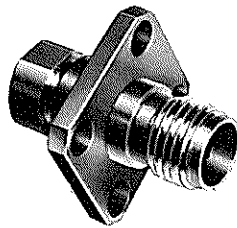
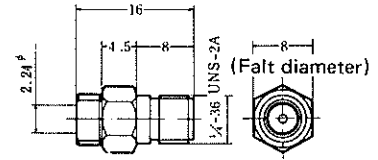

HRS No.	Part No.
CL323-0145-1-09	HRM-100-3(09)
CL323-0146-4-09	*HRM-100-3S(09)

Panel jacks for .085-inch semi-rigid cables

* The shells are passivated, and the tightening fixtures are gold-plated.

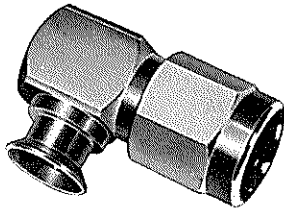
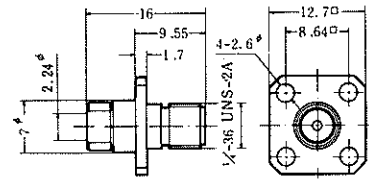

HRS No.	Part No.
CL323-0147-7-09	HRM-100-4(09)
CL323-0148-0-09	*HRM-100-4S(09)

L-type plugs for .085-inch semi-rigid cables

* The shells are gold-plated, and the couplings are passivated.

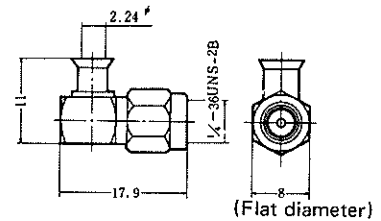

HRM SERIES RF CO-AXIAL CONNECTORS

Dec.1.2018 Copyright 2018 HIROSE ELECTRIC CO., LTD. All Rights Reserved.

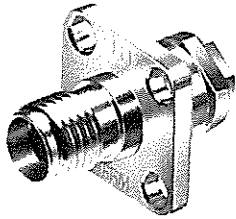

HRS No.	Part No.
CL323-0121-3-09	HRM-100-6S(09)

Panel jacks for .141-inch semi-rigid cables

*The shells and tightening fixtures are passivated, and the cord tubes are gold-plated.

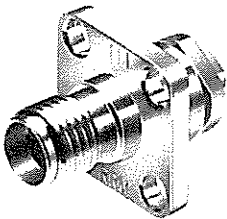
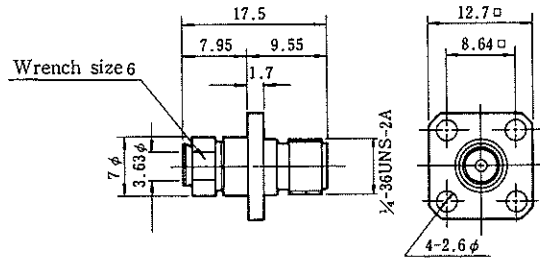

HRS No.	Part No.
CL323-0226-1-40	HRM-111(40)

Panel jacks for .085-inch semi-rigid cables

*The shells and tightening fixtures are passivated, and the cord tubes are gold-plated.

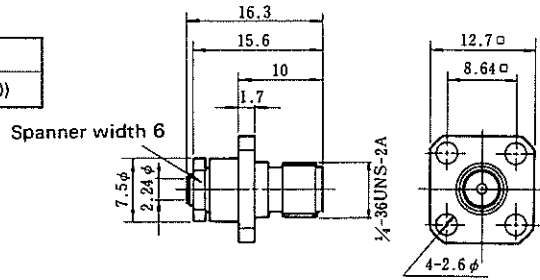

For SC-160 Semi-rigid cable

*Standard product

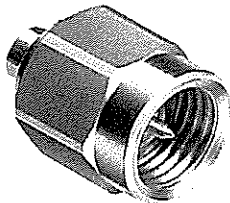

HRS No.	Part No.
CL323-0442-7-40	HRM-100-18B(40)

Connector for SC-160 semi-rigid cables
Shell : nickel-plated, Coupling : passivated
Tightening fittings : gold-plated

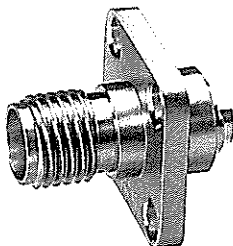
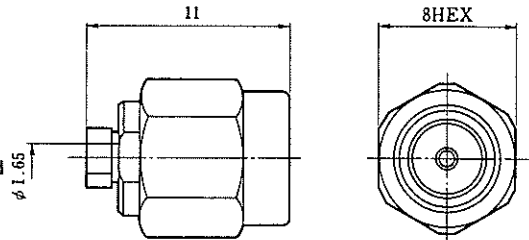

HRS No.	Part No.
CL323-0251-9-40	HRM-100-32S(40)

Connector for SC-160 semi-rigid cables
Shell : passivated, Tightening fittings : gold-plated

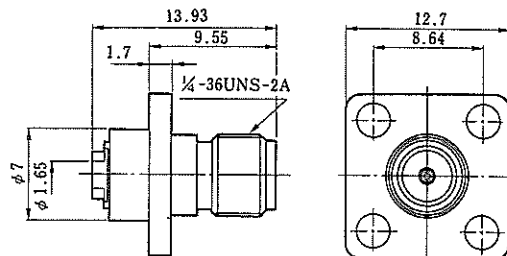

HRM SERIES RF CO-AXIAL CONNECTORS

Connectors for flexible cables HRM-200~299

Two types of cables: RG-142B/U match the connectors for flexible cables. However, the connectors are designed so that they will match both cables.

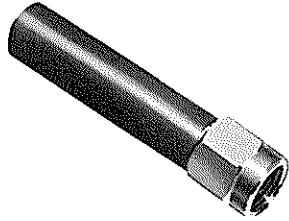

HRS No.	Part No.
* CL323-0006-5-09	HRM-202(09)
* CL323-0117-6	HRM-202S

Plugs for RG-142B/U

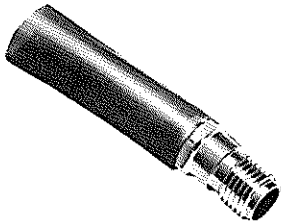
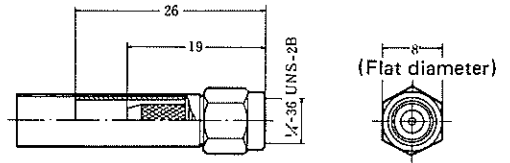

HRS No.	Part No.
CL323-0008-0-09	HRM-204(09)
CL323-0149-2	HRM-204S

Jacks for RG-142B/U

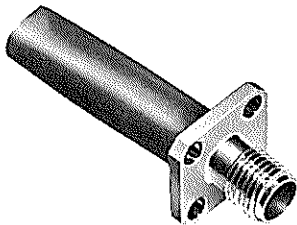
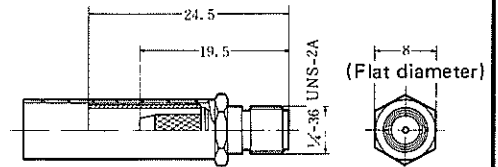

HRS No.	Part No.
CL323-0010-2-09	HRM-206(09)
CL323-0118-9	HRM-206S

Panel jacks for RG-142B/U

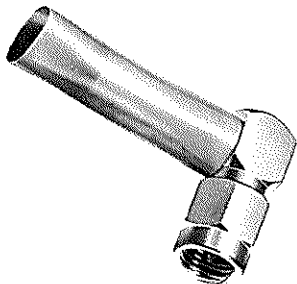
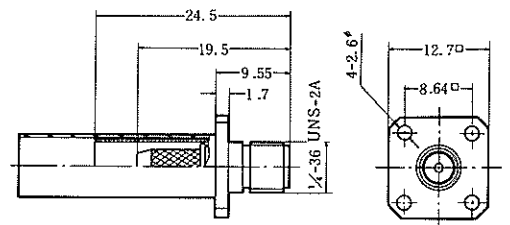

HRS No.	Part No.
* CL323-0012-8-09	HRM-208(09)
* CL323-0119-1	HRM-208S

L-type Plugs for RG-142B/

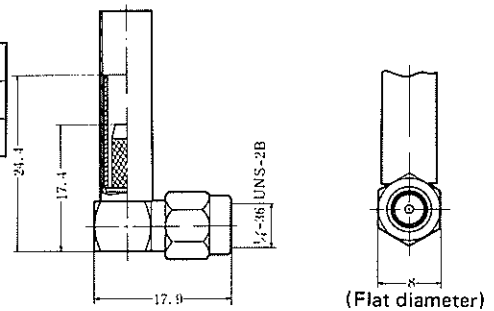

*Standard product

HRM SERIES RF CO-AXIAL CONNECTORS



HRS No.	Part No.	Applicable cable
CL323-0369-9-40	HRM-200-2-C(40)	1.5D-2V
CL323-0412-6-40	HRM-200-2S-C(40)	
CL323-0500-1-40	HRM-200-2S-1C(40)	1.5D-2W

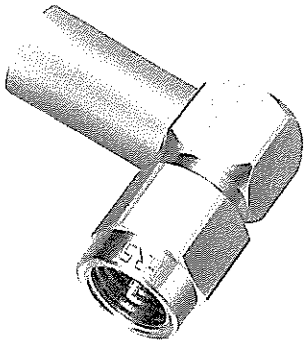

HRS No.	Part No.	Applicable cable
CL323-0371-0-40	HRM-200-4-C(40)	1.5D-2V
CL323-0413-9-40	HRM-200-4S-C(40)	
CL323-0505-5-40	HRM-200-4S-1C(40)	1.5D-2W

L-Type Plug



HRM SERIES RF CO-AXIAL CONNECTORS

Receptacles HRM-300~399

The mounting parts of the receptacles are available in types for mounting strip lines (microstrips, triplates, suspender types), for mounting waveguides, for mounting lead wires, etc.

There are two mounting systems: fastening with machine screws (M2.3) at four or two places.

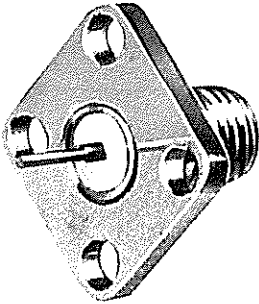

HRS No.	Part No.
* CL323-0013-0-09	HRM-301(09)
* CL323-0058-9	HRM-301S

Fastened with machine screws at four places
Round-bar terminals
Straight receptacles

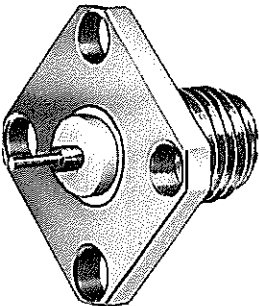
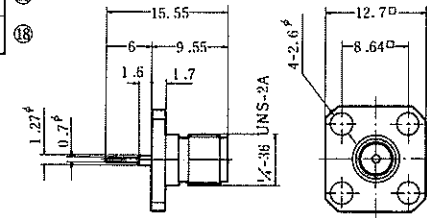

HRS No.	Part No.
* CL323-0014-3-09	HRM-302(09)
* CL323-0059-1	HRM-302S

Fastened with machine screws at four places
Round-bar terminals
Straight receptacles

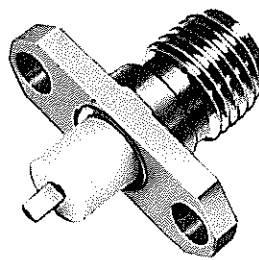
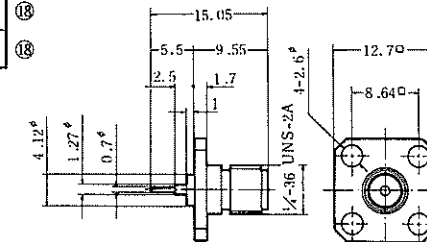

HRS No.	Part No.
* CL323-0015-6-09	HRM-303(09)
* CL323-0060-0	HRM-303S

Fastened with machine screws at two places
Half-cut terminals
Straight receptacles

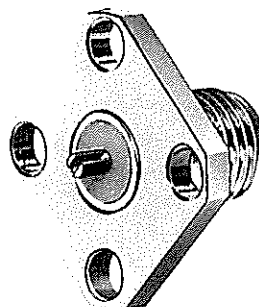
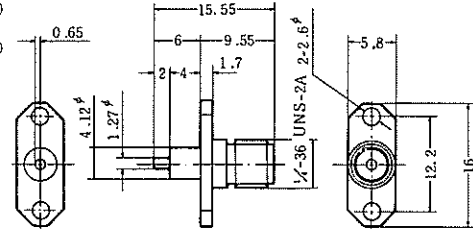

HRS No.	Part No.
CL323-0016-9-09	HRM-304(09)
* CL323-0061-3	HRM-304S

Fastened with machine screws at four places
Slitted terminals
Straight receptacles

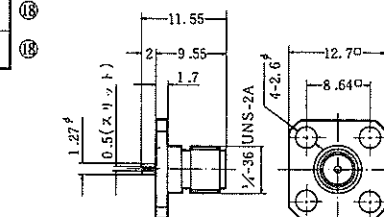

HRM SERIES RF CO-AXIAL CONNECTORS

Dec.1.2018 Copyright 2018 HIROSE ELECTRIC CO., LTD. All Rights Reserved.

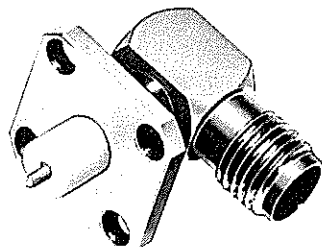

HRS No.	Part No.
* CL323-0017-1-40	HRM-305(40)
* CL323-0062-6-40	HRM-305S(40)

Fastened with machine screws at four places
Half-cut terminals
L-type receptacles

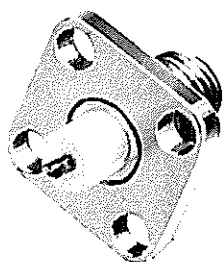
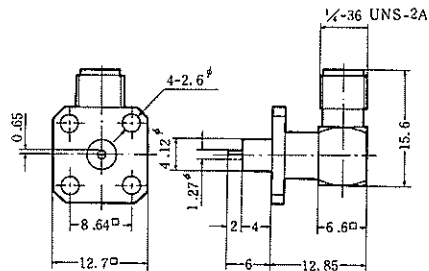

HRS No.	Part No.
* CL323-0018-4-09	HRM-306(09) ⑬
* CL323-0063-9	HRM-306S ⑬

Fastened with machine screws at four places
Half-cut terminals
L-type receptacles

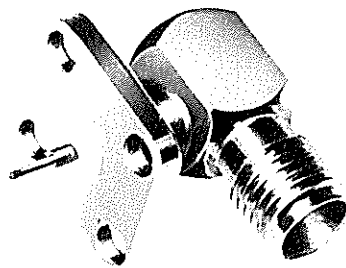
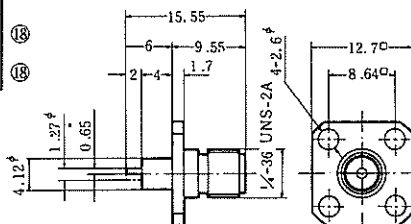

HRS No.	Part No.
CL323-0019-7-40	HRM-307(40)
* CL323-0064-1-40	HRM-307S(40)

Fastened with machine screws at four places
Round-bar terminals
L-type receptacles

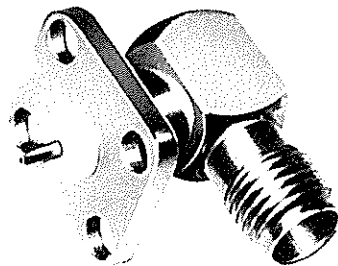
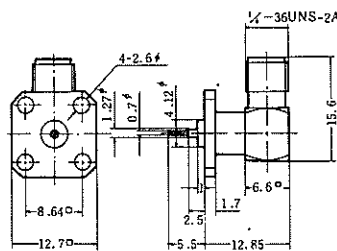

HRS No.	Part No.
CL323-0115-0-40	HRM-300-58S(40)

Fastened with machine screws at four places
Solder terminals
L-type receptacles

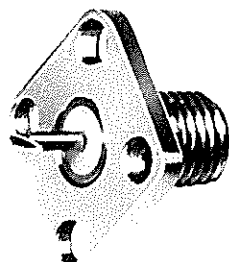
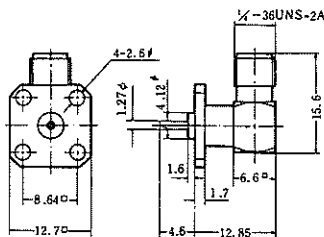

HRS No.	Part No.
* CL323-0120-0	HRM-300-60S

Fastened with machine screws at four places
Solder terminals
Straight receptacles

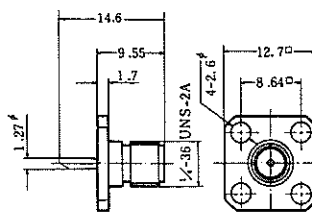

HRM SERIES RF CO-AXIAL CONNECTORS

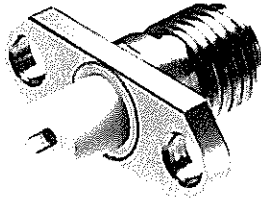

HRS No.	Part No.
CL323-0215-5	HRM-300-11S

Fastened with machine screws at two places
 Tab terminals
 Straight receptacles

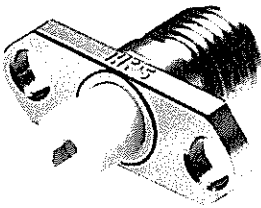
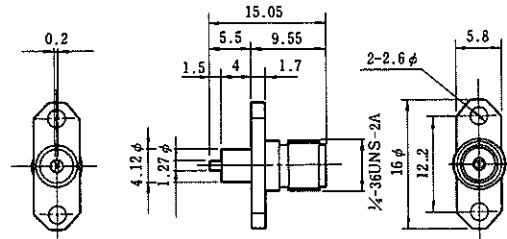

HRS No.	Part No.
CL323-0089-2-09	HRM-300-25(09) ⑮
* CL323-0219-6	HRM-300-25S ⑮

Fastened with machine screws at two places
 Tab terminals
 Straight receptacles

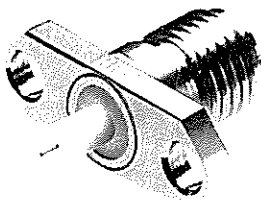
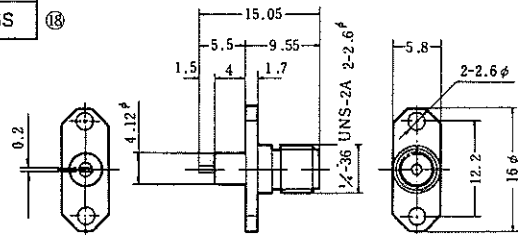

HRS No.	Part No.
CL323-0228-7	HRM-300-110S

Fastened with machine screws at two places
 Round-bar terminals
 Straight receptacles

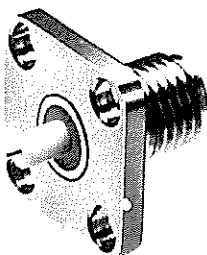
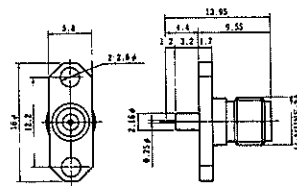

HRS No.	Part No.
CL323-0229-0	HRM-300-118S

Fastened with machine screws at four places
 Round-bar terminals
 Straight receptacles

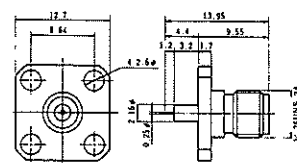

*Standard product

HRM SERIES RF CO-AXIAL CONNECTORS

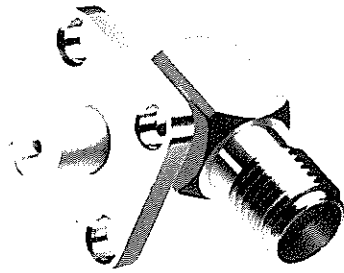

HRS No.	Part No.
CL323-0056-3-40	HRM-309(40)
CL323-0066-7-40	HRM-309S(40)

Fastened with machine screws at four places
Half-cut terminals
L-type receptacles

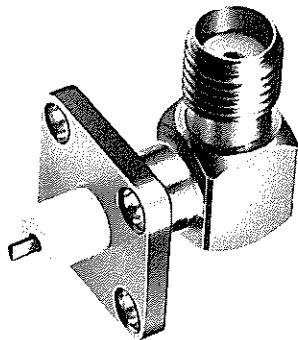
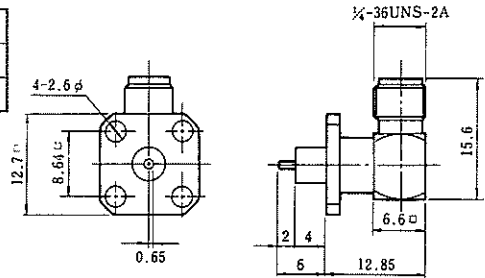

HRS No.	Part No.
CL323-0057-6-40	HRM-310(40)
* CL323-0067-0-40	HRM-310S(40)

Fastened with machine screws at four places
Half-cut terminals
L-type receptacles

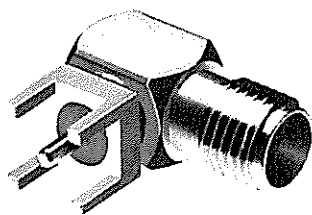
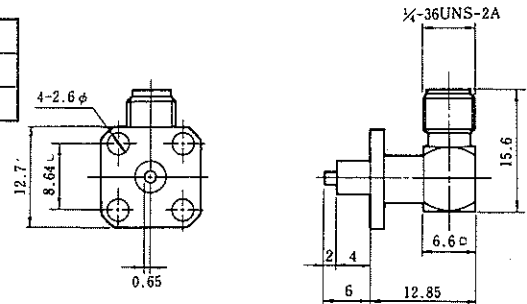

HRS No.	Part No.
CL323-0253-4-40	HRM-300-126S(40)
CL323-0295-4-40	HRM-300-126B(40)

Type for mounting printed circuit boards
L-type receptacles

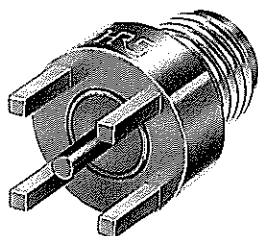
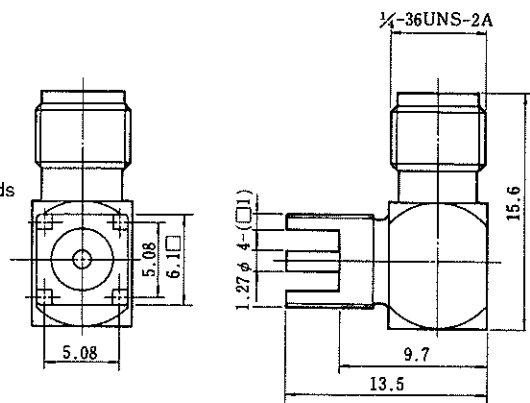

HRS No.	Part No.
CL323-0296-7-40	HRM-300-134B(40)

Printed-circuit-board mounting type straight receptacle

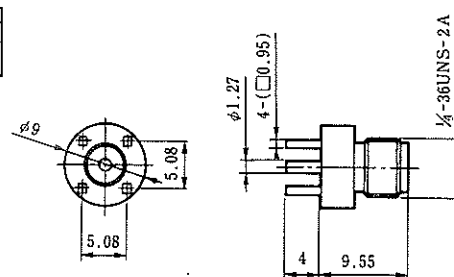

HRM SERIES RF CO-AXIAL CONNECTORS

Plug receptacles HRM-400~499

The mounting parts of the plug receptacles are available in types for mounting strip lines (microstrips, triplates, suspender types), for mounting waveguides, etc. There are two mounting systems: fastening with machine screws (M2.3) at four or two places.

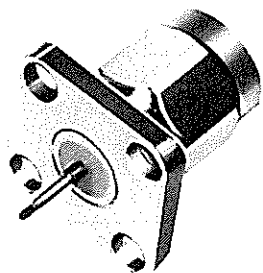

HRS No.	Part No.	
CL323-0021-9-40	HRM-401(40)	⑬
CL323-0070-4-40	HRM-401S(40)	⑬

Fastened with machine screws at four places
Round-bar terminals
Straight plug receptacles

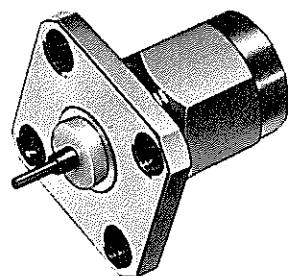

HRS No.	Part No.	
CL323-0022-1-40	HRM-402(40)	⑬
* CL323-0071-7-40	HRM-402S(40)	⑬

Fastened with machine screws at four places
Round-bar terminals
L-type plug receptacles

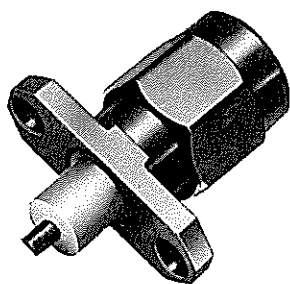

HRS No.	Part No.	
* CL323-0023-4-40	HRM-403(40)	⑬
CL323-0072-0-40	HRM-403S(40)	⑬

Fastened with machine screws at two places
Half-cutter terminals
Straight plug receptacles

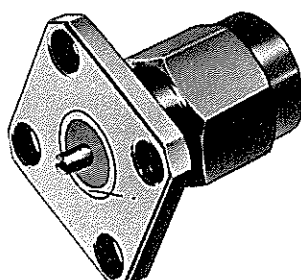
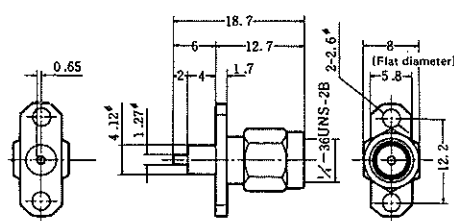

HRS No.	Part No.	
CL323-0024-7-40	HRM-404(40)	⑬
* CL323-0073-2-40	HRM-404S(40)	⑬

Fastened with machine screws at four places
Slot terminals
Straight plug receptacles

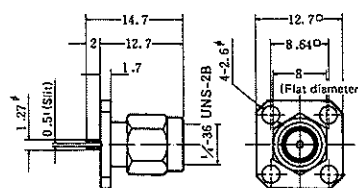

HRM SERIES RF CO-AXIAL CONNECTORS

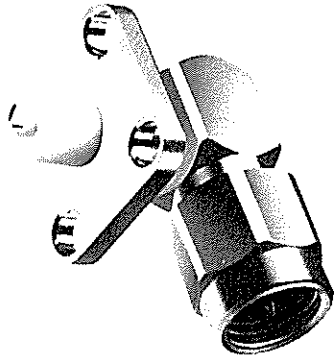

HRS No.	Part No.
CL323-0025-0-40	HRM-405(40)
CL323-0074-5-40	HRM-405S(40)

Fastened with machine screws at four places
Half-cutter terminals
L-type plug receptacles

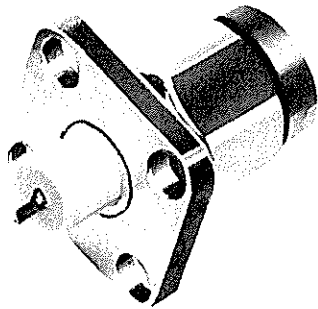
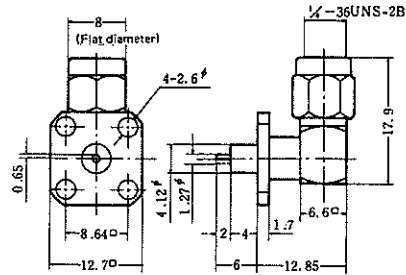

HRS No.	Part No.
CL323-0026-2-40	HRM-406(40)
CL323-0075-8-40	HRM-406S(40)

Fastened with machine screws at four places
Half-cutter terminals
Straight plug receptacles

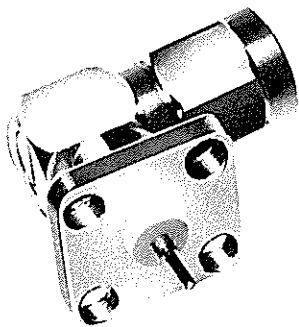
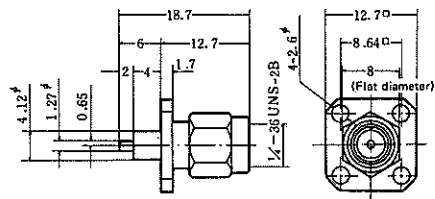

HRS No.	Part No.
CL323-0027-5-40	HRM-407(40)
CL323-0076-0-40	HRM-407S(40)

Fastened with machine screws at four places
Round-bar terminals
L-type plug receptacles

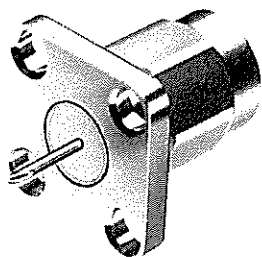
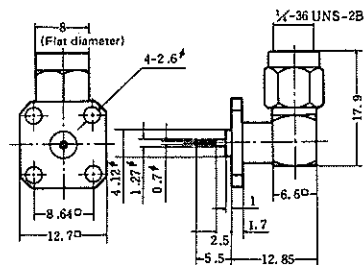

HRS No.	Part No.
CL323-0175-2	HRM-400-36S1

Fastened with machine screws at four places
Solder terminals
Straight plug receptacles

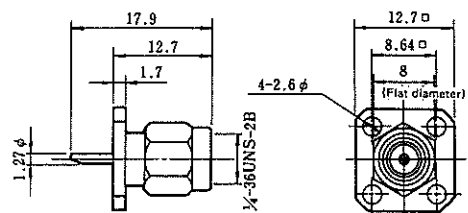

HRM SERIES RF CO-AXIAL CONNECTORS



HRS No.	Part No.
CL323-0245-6-40	HRM-400-41S(40)

Fastened with machine screws at four places
 Tab terminals
 Straight plug receptacles

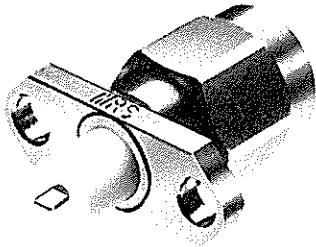
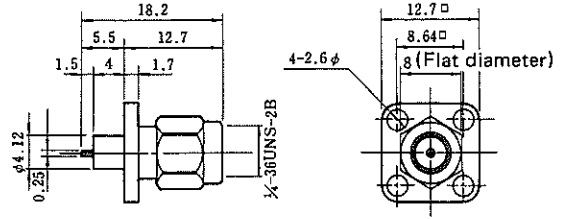

HRS No.	Part No.
CL323-0246-9-40	HRM-400-12S(40)

Fastened with machine screws at two places
 Tab terminals
 Straight plug receptacles

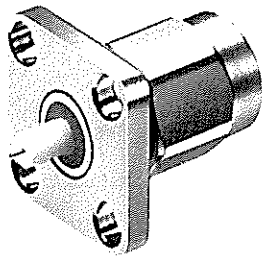
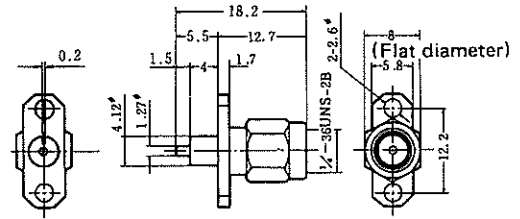

HRS No.	Part No.
CL323-0230-9	HRM-400-42S

Fastened with machine screws at four places
 Round-bar terminals
 Straight plug receptacles

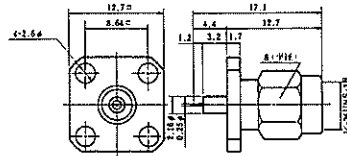

* Standard product

HRM SERIES RF CO-AXIAL CONNECTORS

Adapters HRM-500~599

The following are the adapters connecting between the coupling parts of the HRM series:

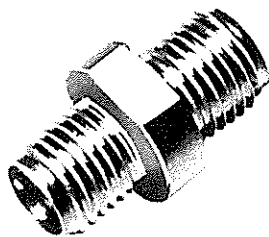

HRS No.	Part No.
* CL323-0029-0	HRM-501
CL323-0156-8	HRM-501S

Female-female adapters
Shells are made of stainless steel and are of the integral type.

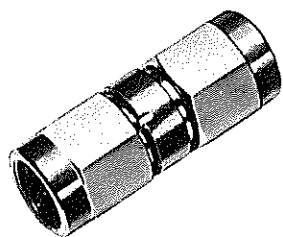
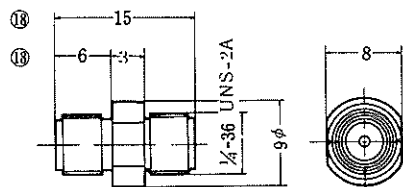

HRS No.	Part No.
* CL323-0030-0-40	HRM-502(40)
CL323-0157-0-40	HRM-502S(40)
CL323-0126-7-40	HRM-502-1(40)
CL323-0123-9-40	HRM-502-1S(40)

Male-male adapters

* Shells are made of stainless steel and are split into two segments.
** Shells are made of stainless steel and are of the integral type.

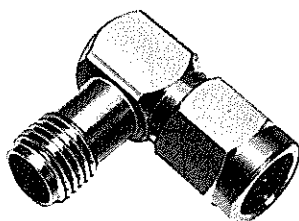
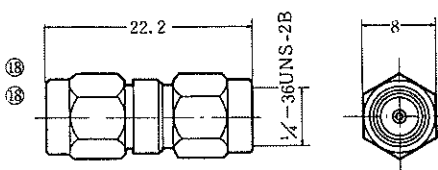

HRS No.	Part No.
* CL323-0031-2-40	HRM-503(40)
* CL323-0112-2-40	HRM-503S(40)

Male-female L-type adapters

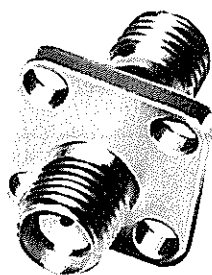
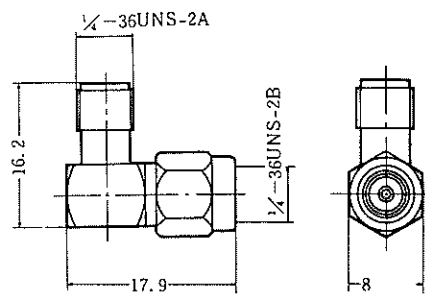

HRS No.	Part No.
* CL323-0034-0-09	HRM-513(09)
* CL323-0657-3	HRM-513SV

Female-female panel adapters
Shells are made of stainless steel and are of the integral type

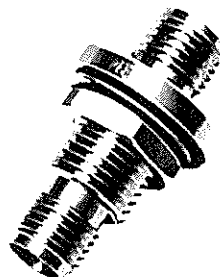
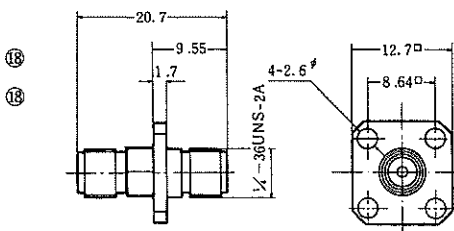

HRS No.	Part No.
CL323-0659-9-40	HRM-500-1SV(40)

Nut-fastened-type panel adapters

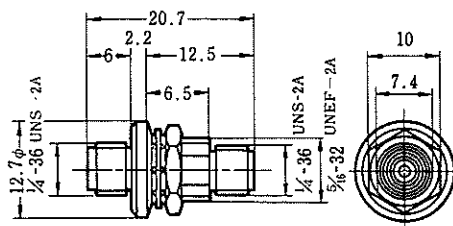

HRM SERIES RF CO-AXIAL CONNECTORS

Converter adapter HRM-500-599

For the converter adapters for connecting the HRM series to other series, see the CL311BWA series.

Shortening connector



HRS No.	Part No.
CL323-0032-5-09	HRM-504(09)

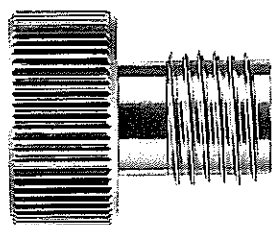
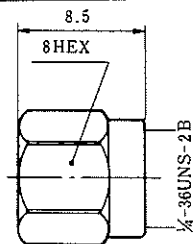

HRS No.	Part No.
CL323-0033-8-40	HRM-505(40)
CL323-0209-2-40	HRM-505S(40)

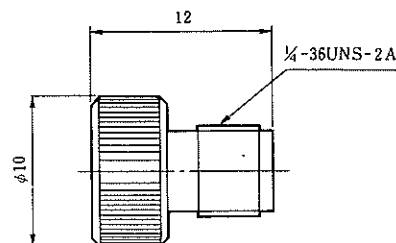

Caps



HRS No.	Part No.
CL323-0038-1-40	HRM-514(40)
CL323-0150-1-40	HRM-514S(40)

Dust caps

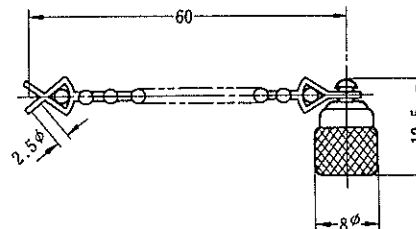

*Standard product

Accessories

Coaxial components such as dummy loads, attenuators, couplers and switches are listed in a separate catalog "Microwave components." Clients are invited to refer to it. Here we introduce two dummy-load products.

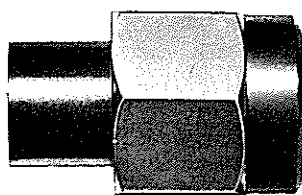

HRS No.	Part No.
CL353-0057-8-40	HRM-601(40)
* CL353-0060-2-40	HRM-601S(40)

Male coupling part dummy loads

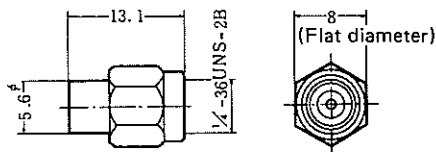

HRS No.	Part No.
CL353-0058-0-40	HRM-602(40)
CL353-0061-5-40	HRM-602S(40)

Female coupling part dummy loads

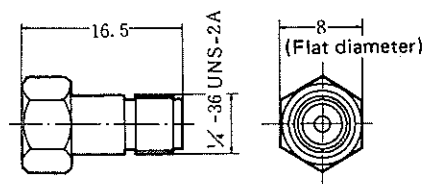

HRM SERIES RF CO-AXIAL CONNECTORS

Airtight type

We offer the following airtight connector products, mainly receptacles and plug receptacles.

We can also design and fabricate of products to meet special specifications, including modifications of the structure and of the mounting specifications. Clients are invited to place orders for them.

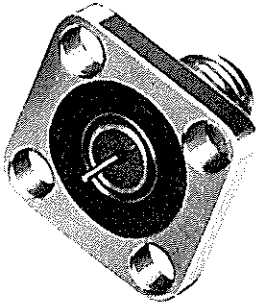

HRS No.	Part No.
CL323-0134-5-09	HRM-300-1H(09)

Fastened with machine screws at four places
Round-bar terminals
Straight receptacles

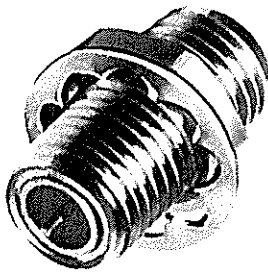
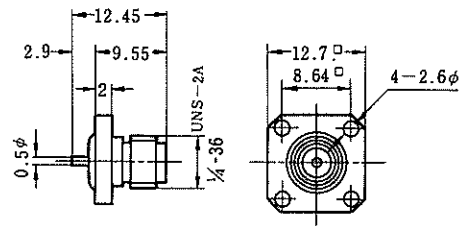

HRS No.	Part No.
CL323-0135-8-09	HRM-300-2H(09)

Nut fastening
Round-bar terminals
Straight receptacles

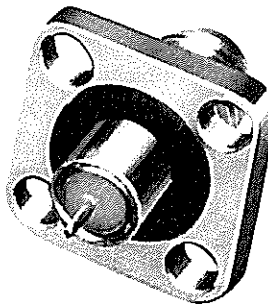
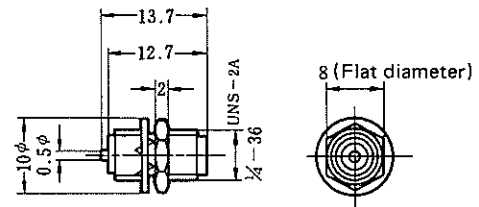

HRS No.	Part No.
CL323-0136-0-09	HRM-300-3H(09)

Fastened with machine screws at four places
Half-cut terminals
Straight receptacles

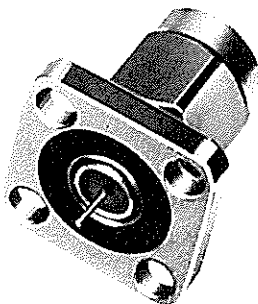
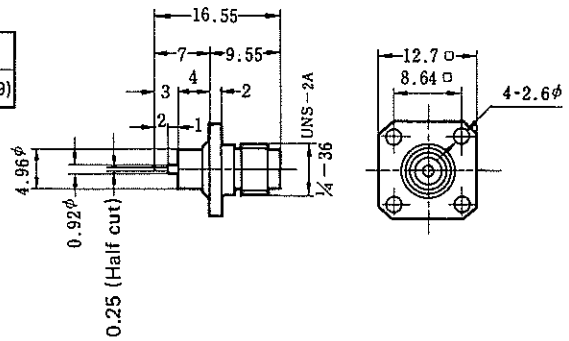

HRS No.	Part No.
CL323-0137-3-09	HRM-400-1H(09)

Fastened with machine screws at four places
Round-bar terminals
Straight plug receptacles

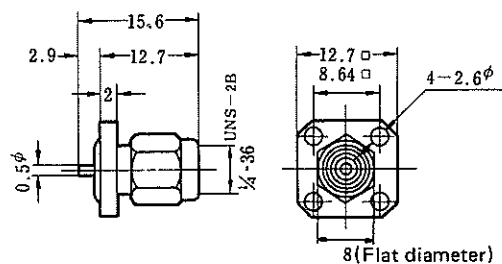

HRM SERIES RF CO-AXIAL CONNECTORS

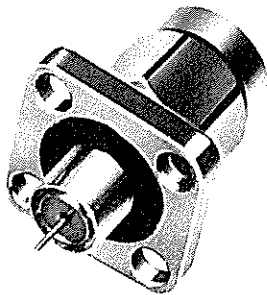

HRS No.	Part No.
CL323-0138-6-09	HRM-400-2H(09)

Fastened with machine screws at four places
Half-cut terminals
Straight plug receptacles

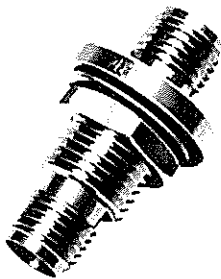
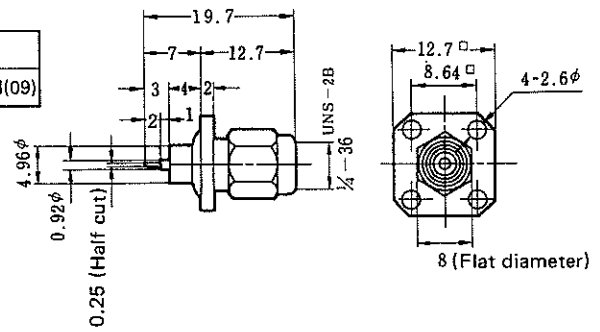

HRS No.	Part No.
CL323-0113-5-09	HRM-500-1H(09)

Nut-fastened-type panel adapters

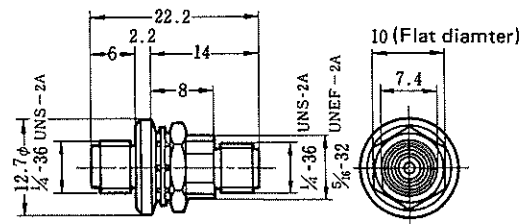

HRM SERIES RF CO-AXIAL CONNECTORS

Technical Guidance

Recommending the S type

The S type refers to products which use stainless steel as the shell material and in which the stainless steel has been passivated. Passivation refers to a type of surface treatment in which the outer surface of the stainless steel is etched with hydrofluoric acid in order to reduce the number of iron particles on it. This forms an oxide film which is thin enough to exert no influence on the electrical conductivity. The corrosion resistance of the stainless steel can be enhanced by performing this treatment. The original goal in developing the S type was to prevent corrosion. That is, in combinations in which the surface treatment of the armor parts is gold plating and the material of the set panel is aluminum, the potential difference between them is rather high (0.9V), and there is the danger that electrolytic corrosion may be induced under certain environmental conditions. As a countermeasure to prevent this, the S type is used, in which the potential difference between the stainless steel and aluminum is relatively low (0.4V).

Not only does the S type have high corrosion resistance, but it has also been proved to have corrosion resistance superior to that of the gold-plated type by acceleration tests with salt-water spraying and by tests in which samples were left for 5000 hours in places where there was much sulfurous acid gas. There are also other advantages. For example, in the gold-plated type, powder from the gold plating is deposited on the surfaces of the coupling parts, but this drawback is absent in the S type. In addition, since expensive gold is not used, the S type can be provided at a lower price than the gold-plated type.

In order to make more effective use of these advantages, it is scheduled in the future to give priority to the S type over the gold-plated type and to make it the standard product. Moreover, although passivation is, as a general rule, the surface treatment of the S type, other treatments may be used as special exceptions in the following cases:

- (1) In the L-bent type, nickel plating is used because the surface of stainless steel is highly discolored by the heat applied during brazing. In this case, the potential difference relative to the aluminum will be 0.6V.
- (2) In connectors for semi-rigid cables (HRM-100~199), gold plating is used in products in which the outer conductors of the cables are soldered (for example, the shell of HRM-101S) in consideration of the soldering properties.

1. Frequency Range

The cut-off frequency of the coaxial transmission path can be found from the following expression:

$$f_{\text{CUT}} = \frac{3 \times 10^{11}}{\pi (d_1 + d_2)/2} \text{ (Hz)} \quad \begin{array}{l} d_1 = \text{Outer diameter of center contact (unit: mm)} \\ d_2 = \text{Inner diameter of outer contact (unit: mm)} \end{array}$$

The cut-off frequency of the HRM series calculated by this expression is 35.5GHz. However, this value is purely a theoretical value in an ideal transmission path. If we take into account the voltage standing wave ratio, the upper limit of the frequency that can be used industrially will be about 18GHz.

At the present time, the upper limit of the guaranteed frequency of the HRM series is 12.4GHz, lower than 18GHz. In certain products, satisfactory results have been obtained with frequencies of up to 18GHz as the typical value. Clients who plan to use frequencies higher than 12.4GHz are requested to inquire.

High-Frequency Properties

HRM SERIES RF CO-AXIAL CONNECTORS

2. Insertion Loss

The insertion loss of the HRM series can be found from the following expression:

$$\text{Loss} \leq 0.03 \sqrt{f \text{ (GHz)}} \text{ (dB)}$$

The insertion loss at 12.4GHz calculated by this expression is 0.1dB. That is, the insertion loss of the HRM series will be 0.1dB or less throughout the entire guaranteed band. This value has been confirmed.

3. High-Frequency Loss

The high-frequency loss of the HRM series has values of 100dB or more within the range of the guaranteed frequencies under the following two conditions: that the couplings are tightened with the prescribed torque, and that the sets and connectors are thoroughly fastened with machine screws.

4. Performance properties of the S Type

In the gold-plated type there will be little conductor loss because the electromagnetic field will be concentrated at the gold-plated parts because of the skin effect. However, in the S type the conductor loss will be larger because the electromagnetic field will be distributed in the stainless-steel parts. However, it will be nearly negligible since the transmission path is short (the length of the transmission path is 15.2mm when a typical receptacle and a plug receptacle are coupled together). The skin will be rough as a result of the passivation, but this has no influence at all on the performance characteristics because the roughness is far less than the finishing precision of the cutting.

1. Average Power

The permissible average power of the connectors cannot be determined unconditionally because a number of indeterminate conditions must be included, such as the frequency, the voltage standing wave ratio, the heat radiated by the device, the modulation ratio, etc. However, the value $50/\sqrt{f \text{ (GHz)}} \text{ (W)}$ can be applied as a tentative yardstick value for the HRM series. Even this value cannot be said to be an absolute yardstick on account of factors such as the heat radiation conditions. In actual practice, 50W has been applied at 6GHz.

2. Peak Power

The peak power of the connectors is determined by their breakdown voltage. In the HRM series, the peak power is about 20kW.

Note that the values of both the average power and the peak power are values applicable under the following conditions:

- (1) There is to be a state of normal temperature, normal humidity, and normal pressure.
- (2) In products to which cables are connected, priority is to be given to the permissible power values of the cables. Even in cases where the cables have a higher permissible power than the connectors, there are to be no defects in the wiring connections.
- (3) There is to be no metal powder on the coupling surfaces of the connectors. Care must be taken especially in the gold-plated type, since there is a tendency for metal powder to be deposited on the coupling surfaces of this type.

Permissible Electric Power

HRM SERIES RF CO-AXIAL CONNECTORS

Tightening Torque of Couplings

Suitable values for the tightening torque of couplings of the HRM series are 6 ~ 10kg-cm. As for which values ought to be chosen for use within this range, the most suitable tightening torque is 6kg-cm when no particular vibrations are applied except during transport, or 10kg-cm in environments where vibrations are applied.

The following is the basis on which the range of 6 ~ 10kg-cm was established. First, in vibration tests simulating the vibration conditions that occur during transport, it has been confirmed that loosening does not occur when the couplings are tightened with a torque of 3kg-cm. Thus, allowing a safety factor of 2 times, the value was set at 6kg-cm. The upper limit value of 10kg-cm was established on the basis of the amount of dimensional changes in the outer diameter of the male coupling part, which is $4.56\phi \pm 0.02$.

Thus, the tightening torque of the couplings of the HRM series has a narrow range, and problems will occur if they are tightened with a torque outside of this range. Consequently, we recommend that you use an 8mm x 6kg-cm or 8mm x 10kg-cm torque wrench when tightening the couplings.

Standard Cables

The standard cables of the HRM series have the following dimensions, structures and materials:

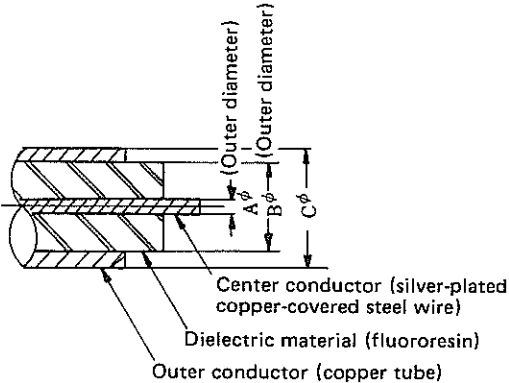
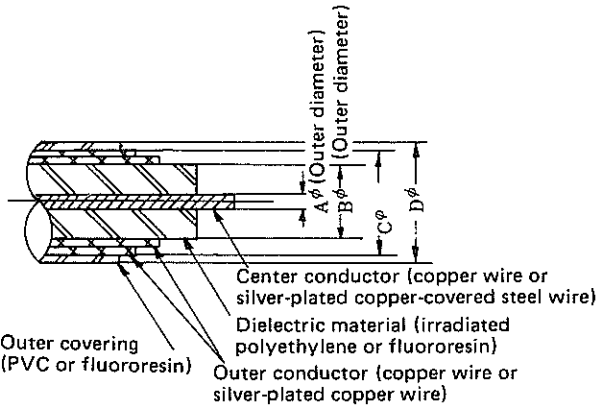
Semi-rigid cables				Flexible cables				
 <p style="text-align: center;">Center conductor (silver-plated copper-covered steel wire) Dielectric material (fluororesin) Outer conductor (copper tube)</p>				 <p style="text-align: center;">Center conductor (copper wire or silver-plated copper-covered steel wire) Dielectric material (irradiated polyethylene or fluororesin) Outer conductor (copper wire or silver-plated copper wire) Outer covering (PVC or fluororesin)</p>				
Unit: mm				Unit: mm				
Type of cable	Aφ	Bφ	Cφ	Type of cable	Aφ	Bφ	Cφ	Dφ
.141-inch semi-rigid cable	0.912φ	2.946φ ±0.025 ~3.01φ ±0.025	3.581φ ±0.025	*3D-2W (Irrax cable)	0.90φ ±0.02	3.0φ ±0.2	4.4φ	5.6φ ±0.3
.085-inch semi-rigid cable	0.511φ	1.671φ ±0.025	2.197φ ±0.025	RG-142B/U	0.991φ	2.95φ ±0.12	4.34φ	4.95φ ±0.12

*Not the same as the 3D-2W in the JIS standards and NTT specifications.

HRM SERIES RF CO-AXIAL CONNECTORS

Tools for connecting wiring

Below are a table giving an overview of the tools used for connecting the wiring of the HRM series and a table listing the tools used for typical products:

Part No.	Overview of tool	Special remarks
HRM-T-1	Positioning tool for center contacts of female coupling parts	
HRM-T-2	Positioning tool for center contacts of male coupling parts	
HRM-T-3	Tapering tool for tips of center conductors of .141-inch semi-rigid cables	*Unsuitable for use as a mass-production tool.
HRM-T-4 UM.MSS-T-1 PO-P-2-T	Tool for crimp bonding of ferrules (sleeves) of connectors for flexible cables	
HRM-T-5	Tool for bending .141-inch semi-rigid cables	
HRM-T-6	Soldered positioning and cutting tool for .141-inch semi-rigid cables	*Unsuitable for use as a mass-production tool.
HRM-T-7	Tool for mounting HRM-101 and 101S couplings on shells	
HRM-T-8	Soldered positioning and cutting tool for .085-inch semi-rigid cables	*Unsuitable for use as a mass-production tool.
HRM-T-9	Tool for bending .085-inch semi-rigid cables	

Part No.	Type of cable used	Recommended tools
HRM-101,101S	.141-inch semi-rigid cables	HRM-T-3,5,6,7
HRM-102,102S	.141-inch semi-rigid cables	HRM-T-1,5,6
HRM-103,103S	.141-inch semi-rigid cables	HRM-T-1,5,6
HRM-104,104S	.141-inch semi-rigid cables	HRM-T-2,5
HRM-100-4,100-4S	.085-inch semi-rigid cables	HRM-T-2,8,9
HRM-100-1,100-1S	.085-inch semi-rigid cables	HRM-T-2,8,9
HRM-100-2,100-2S	.085-inch semi-rigid cables	HRM-T-1,8,9
HRM-100-3,100-3S	.085-inch semi-rigid cables	HRM-T-1,8,9
HRM-202, 202S	3D-XW (Irrax cable) RG-142B/U	HRM-T-2,4
HRM-204, 204S	3D-XW (Irrax cable) RG-142B/U	HRM-T-1,4,6
HRM-206, 206S	3D-XW (Irrax cable) RG-142B/U	HRM-T-1,4,6
HRM-208, 208S	3D-XW (Irrax cable) RG-142B/U	HRM-T-2,4
HRM-200-2-C, 2S-C HRM-200-4-C, 4S-C	1.5D-2V	UM.MSS-T-1
HRM-200-2S-1C HRM-200-4S-1C	1.5D-2W	PO-P-2-T

HRM-T-1

Locator for jacks

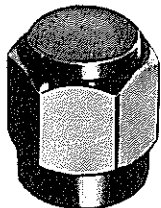

HRM-T-2

Locator for plugs

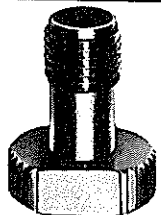

HRM-T-3

Tool for fabricating tips of .141-inch cables (for laboratory use)

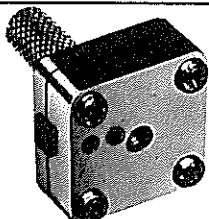

HRM-T-4

Crimp tool

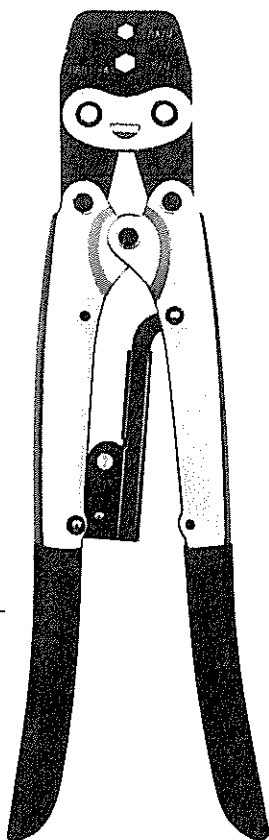

HRM-T-5, T-9

Tool for bending cables

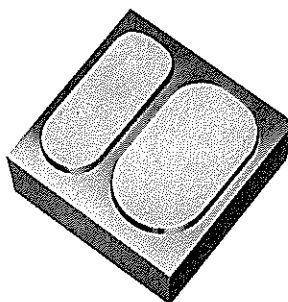

HRM-T-7

Coupling inserting tool

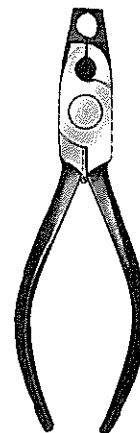

HRM-T-6, T-8

Soldering tool

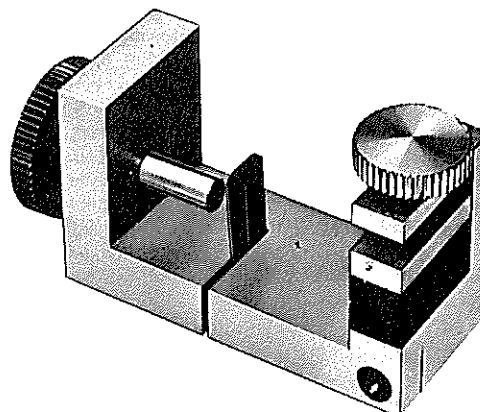

HRM SERIES RF CO-AXIAL CONNECTORS

Connecting Methods

1. HRM-101, 101S

(1) Cut cable (refer to Fig. (1))

When cutting semi-rigid cables, cut them at the actually needed length ℓ plus 2.3mm.

Note 1: Take care that the cut surface is vertical.

Note 2: Length ℓ should be the length of the outer conductor of the cable after the wiring has been completely connected.

Fig.(1)

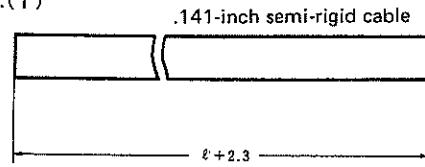

(2) Fasten the cable to the shell by soldering.
(Use HRM-T-6)

i) Fasten ① in Fig. (2) with a vice.

ii) As shown in the figure, pass the P shell through the cable, and fasten the cable by tightening ③.

iii) Next, tighten ② so that the cable tip protrudes 2.3mm from the tip of the shell.

iv) Fasten the shell by soldering it to the cable.

Note 1: It is desirable to use at this time a soldering iron of about 80W.

Note 2: The solder must be applied evenly on the circumference.

Note 3: During soldering, be careful not to allow the tip of the shell to move away from ②.

Note 4: Screw ③ must be tightened tightly so that the cable will not move as a result of the thermal stress generated by the soldering.

Note 5: Polish the soldered part of the cable in advance with sandpaper or the like so that the solder will adhere easily to it.

Fig.(2)

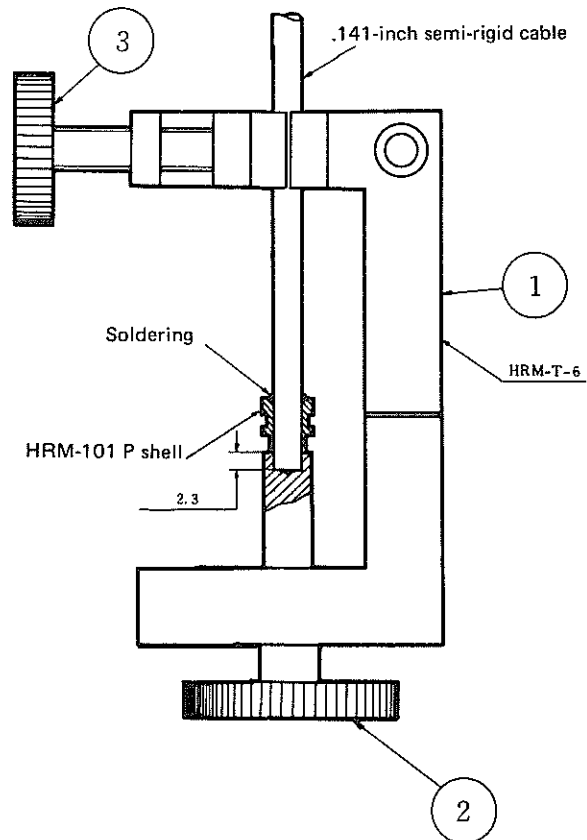

(3) Cut off the outer conductor of the cable with a fret saw at the shell-tip position. (Refer to Fig. (3).)

Note 1: Be careful not to damage the shell tip when cutting the cable, and be sure that the shell tip and the cut surface of the cable will be on the same surface.

Note 2: The slit with a width of 0.4 on the tool is provided so that the fret saw will stop between the center conductor and outer conductor of the cable. Care is necessary because if the tool is damaged during cutting the depth of the slit will change, and consequently the center conductor of the cable will be damaged.

Fig.(3)

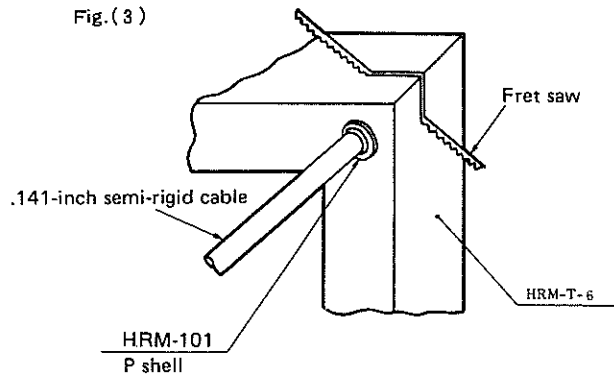

HRM SERIES RF CO-AXIAL CONNECTORS

(4) Cut the cable insulation vertically at the shell tip (using a razor) and remove it. (Refer to Fig. (4).)

Note 1: Be careful that the center conductor of the cable is not bent or damaged. Check to make sure that the part of the center conductor protruding from the shell tip is $2.3\text{mm} \pm 0.2$.

Fig.(4)

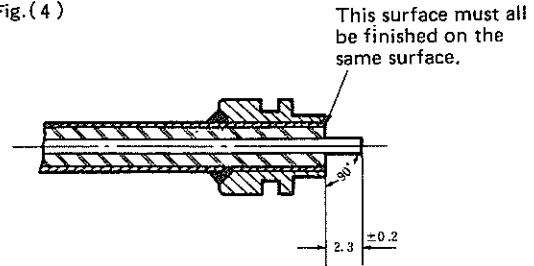

(5) Cut the tip of the center conductor to a 60° angle.

- i) Tighten and fasten HRM-T-3 on the hand drill by means of the chuck, as shown in Fig. (5).
- ii) Insert the block in Fig. (4) into the handhole at the center of HRM-T-3, and turn HRM-T-3 with the hand drill. (This tool is used on an experimental level. In mass production, work with a lathe or the like.)

Fig.(5)



(6) Insert the coupling

- i) Incorporate the rubber packing and the spring washer as shown in Fig. (6).
- ii) Shorten the spring washer with HRM-T-7 as shown in Fig. (7) until it matches the outer diameter of the shell, and insert the coupling from the direction indicated by the arrow.

Note 1: Check to make sure that the spring washer drops accurately into the groove in the coupling as shown in Fig. (8). (If it is inserted correctly, the dimensions of the coupling tip and of the shell tip ought to be 2.7, as shown in Fig. (8).)

Fig.(6)

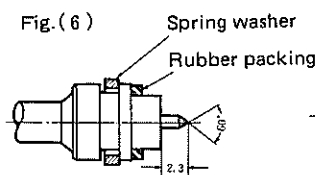

Fig.(7)

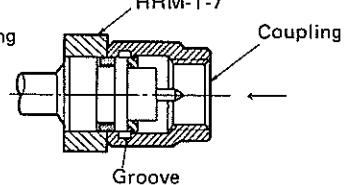
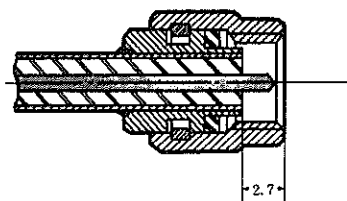

Fig.(8)

View of wiring connection when completed



HRM SERIES RF CO-AXIAL CONNECTORS

2. HRM-102, 102S, 103, 103S

(1) Cut the cable.

When cutting semi-rigid cables, cut them at the actualy needed length ℓ plus 2.3mm.

Note 1: Take care that the cut surface is vertical.

Note 2: Length ℓ should be the entire length of the outer conductor of the cable after the wiring has been completely connected.

Fig.(9)

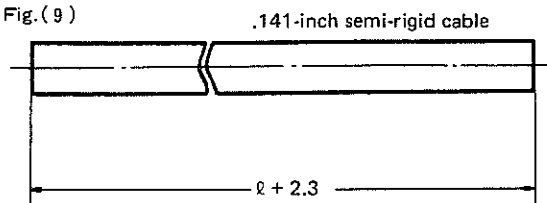

(2) Fasten the cable to the shell by soldering.
(Use HRM-T-6)

i) Fasten ① in Fig. (10) with a vice.

ii) As shown in the figure, pass the tightening fixture through the cable, and fasten the cable by tightening ③.

iii) Next, tighten ② so that the cable tip protrudes 2.3mm from the tip of the shell.

iv) Fasten the tightening fixture by soldering it to the cable.

Note 1: It is desirable to use at this time a soldering iron of about 80W.

Note 2: The solder must be applied evenly on the circumference.

Note 3: During soldering, be careful not to allow the tip of the tightening fixture to move away from ②.

Note 4: Screw ③ must be tightened tightly so that the cable will not move as a result of the thermal stress generated by the soldering.

Note 5: Polish the soldered part of the cable in advance with sandpaper or the like so that the solder will adhere easily to it.

Fig.(10)

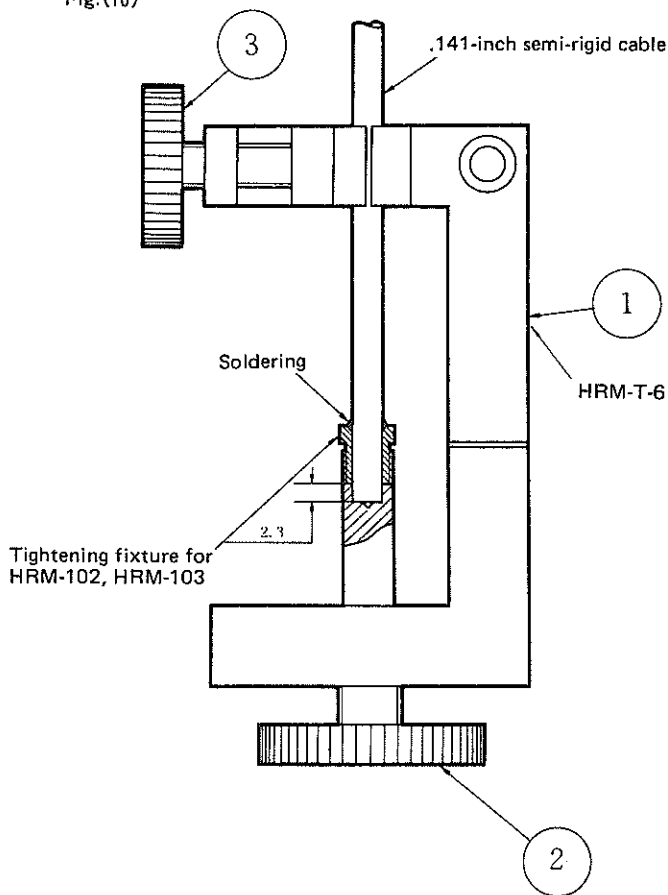

(3) Cut off the outer conductor of the cable with a fret saw at the tip position of the tightening fixture. (Refer to Fig. (11).)

Note 1: Be careful not to damage the tip of the tightening fixture when cutting the cable, and be sure that the tip of the tightening fixture and the cut surface of the cable will be on the same surface.

Note 2: The slit with a width of 0.4 on the tool is provided so that the fret saw will stop between the center conductor and outer conductor of the cable. Care is necessary because if the tool is damaged during cutting the depth of the slit will change, and consequently the center conductor of the cable will be damaged.

Fig.(11)

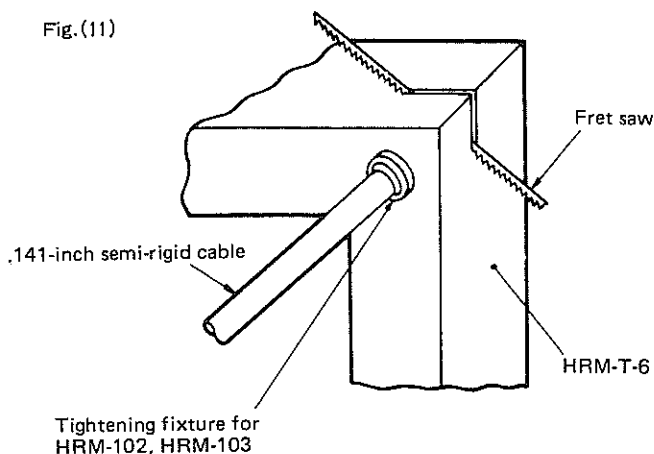

Dec.1.2018 Copyright 2018 HIROSE ELECTRIC CO., LTD. All Rights Reserved.

HRM SERIES RF CO-AXIAL CONNECTORS

(4) Cut the cable insulation vertically at the tip of the tightening fixture (using a razor) and remove it. (Refer to Fig. (12).)

Note 1: The tip must be finished so that it will all be on the same surface.

Note 2: Be careful not to bend or damage the center conductor of the cable.

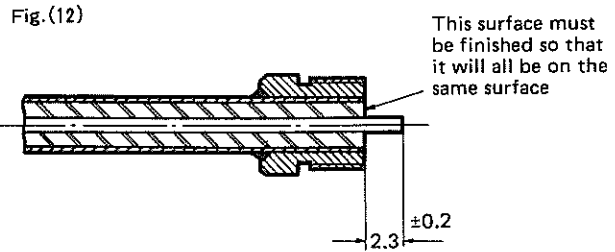

(5) Solder the female end onto the center conductor of the cable. (Refer to Figs. (13) and (14).)

i) Put the positioning plate of the center conductor ① into the groove of the HRM-T-6 proper.

ii) Mount the block in Fig. (12) onto HRM-T-6, as shown in Fig. (13). The tip will strike against ①. Pass the center conductor of the cable through the groove of ①, and fasten at that position.

iii) Fit the female contact for HRM-102, HRM-103 into the contact holder ③. Perform preliminary soldering and insert as shown in Fig. (13) from the horizontal hole in the HRM-T-6 proper ④. Align the center conductor of the cable with the female contact hole while heating the female contact with the soldering iron, and press it until it strikes against ①.

iv) After the soldering is finished, remove ① and remove the block from the HRM-T-6 proper ④ and the contact holder ③. Finish the place which was soldered with a razor or the like uniformly on the circumference. (Refer to Fig. (14).)

Note 1: It is desirable to use at this time a soldering iron of about 20 ~ 30W.

Note 2: Be careful that extra solder does not flow onto the center conductor of the cable at the part $0.4^{+0}_{-0.04}$ in Fig. (14).

Note 3: Check the dimensions of Fig. (14) after soldering the female contact.

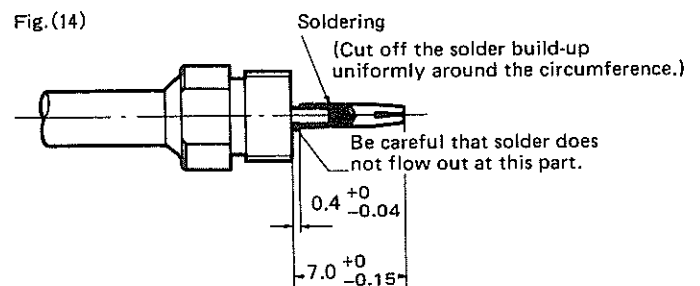
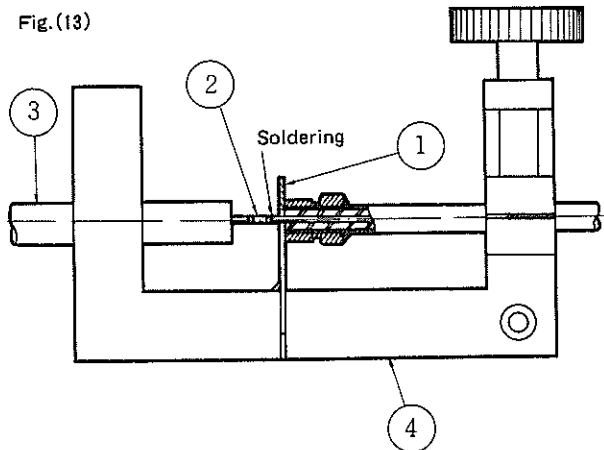

(6) Screw the block into the connector proper. Connection of the wiring will be completed as in Fig. (15) when the block in Fig. (14) is screwed into the connector proper.

Note 1: The opening part must be fastened by means of HRM-T-1 (locator) so that the connector insulation will not move when the block is being screwed in.

Note 2: The screw must be tightened with a torque of 30kg-cm or more. When it is especially necessary to prevent the screw from loosening, lock paint is to be applied as is shown in the figure.

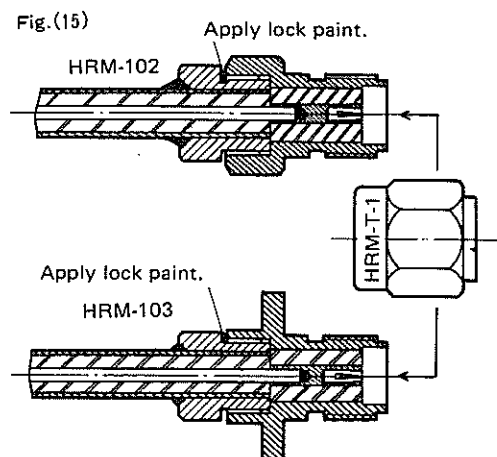

HRM SERIES RF CO-AXIAL CONNECTORS

3. HRM-104, 104S

- (1) Process cable ends. (Refer to Fig. (16).)
 Let the center conductor of the cable protrude 2.5mm and remove the outer conductor and insulation.
- Note 1: Finish the outer conductor and insulation vertically and uniformly with a fret saw or the like.
- Note 2: When cutting, be careful not to damage the center conductor.

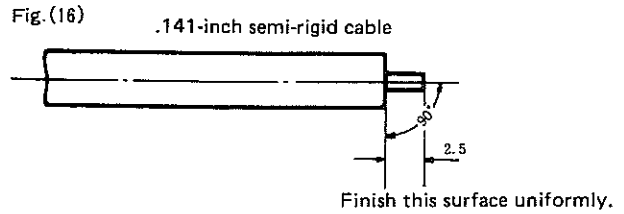

- (2) Solder the center conductor of the cable to the male contact of the connector. (Refer to Fig. (17).)
- Fit HRM-T-2 so that the female contact of the connector and the insulation will not move, and hold it firmly in place with a vice.
 - Remove the screw cover, insert the cable after end processing as shown in Fig. (16) through the cord inlet, and solder it as shown in Fig. (17).

- Note 1: Insert the cable until the tip of the outer conductor comes into contact with the inner surface of the connector shell, as shown in Fig. (17). Insert the center conductor into the groove of the male contact of the connector, and solder it.
- Note 2: When soldering, be careful not to get solder on the center conductor of the cable or on the outer surface of the male contact of the connector.
- Note 3: It is desirable to use at this time a soldering iron of about 20 ~ 30W. Its tip must be narrowed to facilitate the work.
- Note 4: When soldering, be careful to avoid knobby soldering. (To check this point, rotate the cable after soldering.)

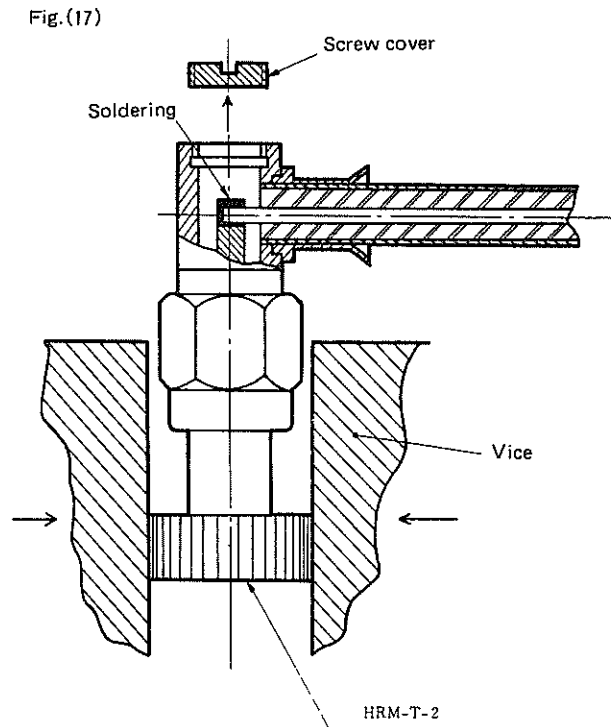

- (3) Solder the outer conductor.
- Fit HRM-T-2 into the opening part as shown in Fig. (18), hold it in a vice, and solder the outer conductor of the cable and the connector shell.
- Note 1: It is desirable to use at this time a soldering iron of about 80W.
- Note 2: Apply the solder uniformly on the circumference, and carry out the soldering as speedily as possible.
- Note 3: Polish the soldered part of the cable in advance with sandpaper or the like so that the solder will adhere easily to it.

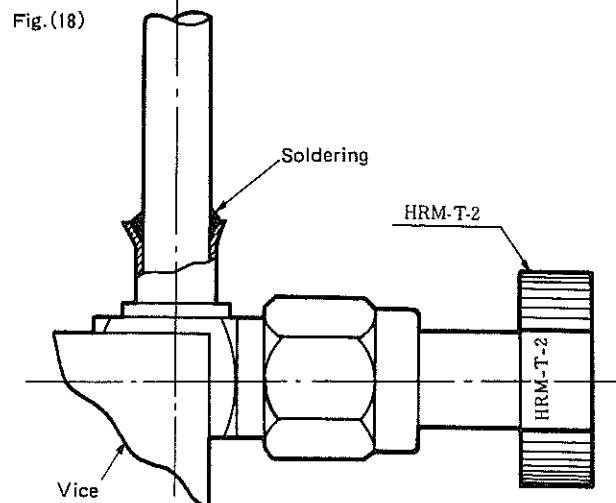

HRM SERIES RF CO-AXIAL CONNECTORS

- (3) Remove the locator and screw on the screw cover. Then the wiring connections will be completed, as shown in Fig. (19).

Fig. (19)

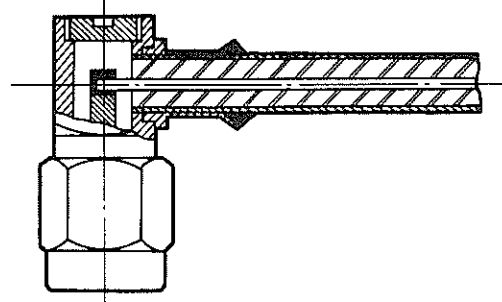

Addendum

When connectors of the HRM series are to be connected and used with semi-rigid cables, their performance properties, like those of other types of connectors, will be governed largely by the quality of the wiring connection work. The same thing can be said with reference to connection of the wiring of flexible cables as well. However, in cases where even better performance characteristics are needed, the precautions described above must be observed. When semi-rigid cables are to be bent in use, tools like those shown in Fig. (20) (HRM-T-5, 9) can be used to bend them with radii of curvature of 6R, 8R, 10R or 12R, respectively. If they are to be used in a spiral shape, the rear surfaces of (HRM-T-5, 9) are used. This is shown in the photograph. Fig. (21) shows the V.S.W.R. data for semi-rigid cables that are connected in bent shape as shown in the photograph and for those that are connected straight. It is clear that there are no large differences in the characteristic features.

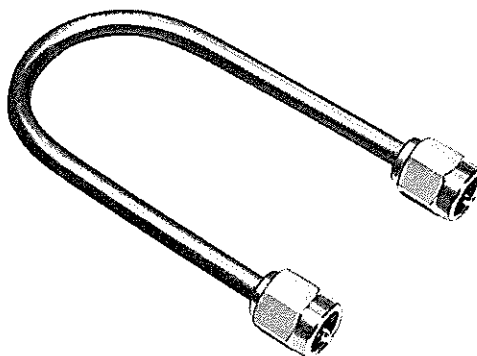

Fig. (20)

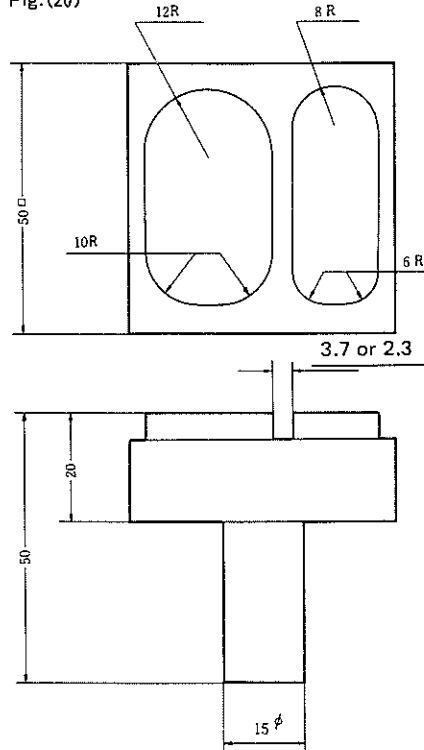
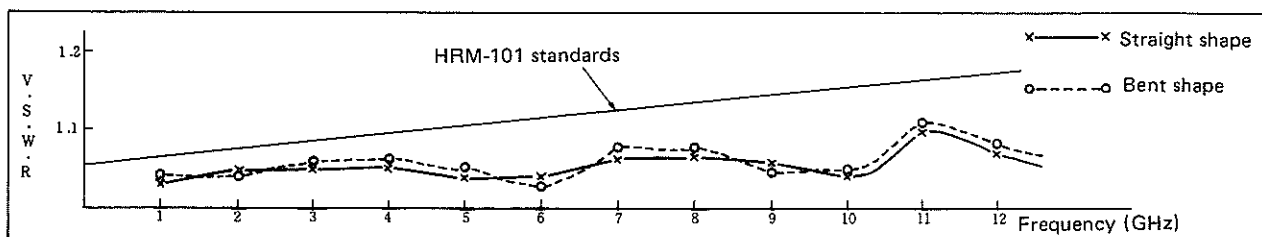

Fig. (21)



HRM SERIES RF CO-AXIAL CONNECTORS

4. HRM-202, 202S

(1) Process cable ends (Refer to Fig. (22).)

- i) Cut off 10mm of the outer covering of the cable (RG-142B/U Next cut off the outer conductor and insulation so that 2.3mm of the center conductor will protrude.

Note 1: When cutting the housing and insulation, be careful not to damage the outer conductor and the center conductor.

Note 2: Be sure to cut the cable insulation vertically and flatly.

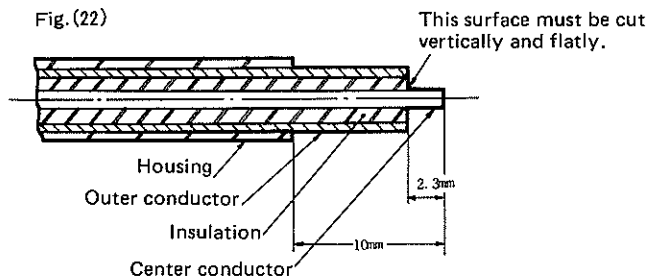

(2) Solder the center conductor

Hold the male contact for HRM-202 in place with a vice as shown in Fig. (23) and solder it to the center conductor of the cable.

Note 1: Before soldering, apply preliminary solder on the male contact in advance.

Note 2: It is a good idea to make a hole of 0.8φ, as shown in Fig. (23), at the part where the male contact is to be held in the vice.

Note 3: In the case of cables using Irrax insulation, be careful to perform the soldering speedily so that the tip will not dissolve as a result of the heat during soldering.

Note 4: The build-up of solder after soldering must be finished uniformly on the circumference. To check the strength of the soldering, pull the male contact with a force of about 1 kg (2.47 lb.).

Note 5: Be careful not to allow a gap to be produced between the insulation and the contact after soldering.

Note 6: Be careful not to allow the male contact to be soldered in a bent position towards the center conductor of the cable.

Note 7: It is desirable to use a soldering iron of about 20 ~ 30W.

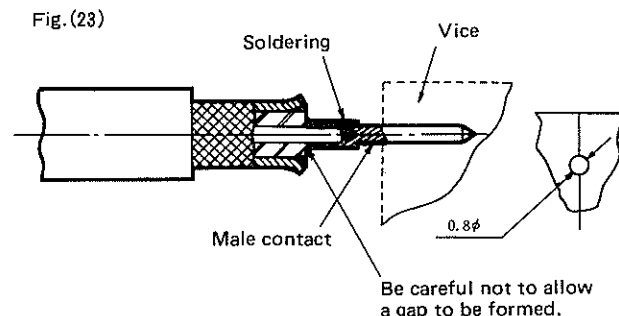

(3) After passing the boot and solderless sleeve over the cable, insert the cable through the connector shell cord inlet, and crimp the ferrule (sleeve) in a hexagonal shape with HT303/HRM-T-4 (Refer to Fig. (24).)

- i) To insert the cable, align the male contact with the hole in the insulation, and insert the connector shell between the dielectric material of the cable and the outer conductor.

- ii) Insert the ferrule (sleeve) until it strikes against the uneven part of the shell, as shown in Fig. (24), and crimp it in a hexagonal shape with HT303/HRM-T-4

Note 1: Insertion of the cable is finished when the uneven part of the male contact strikes against the connector insulation. It is a good idea to fit the HRM-T-2 (the locator) in the opening part in order to prevent the connector insulation from moving at this time. Crimping of the ferrule (sleeve) is performed first on the cable side and next on the connector side. (Be careful about the order; if the wrong order is followed, the clamping force will be reduced by one half.)

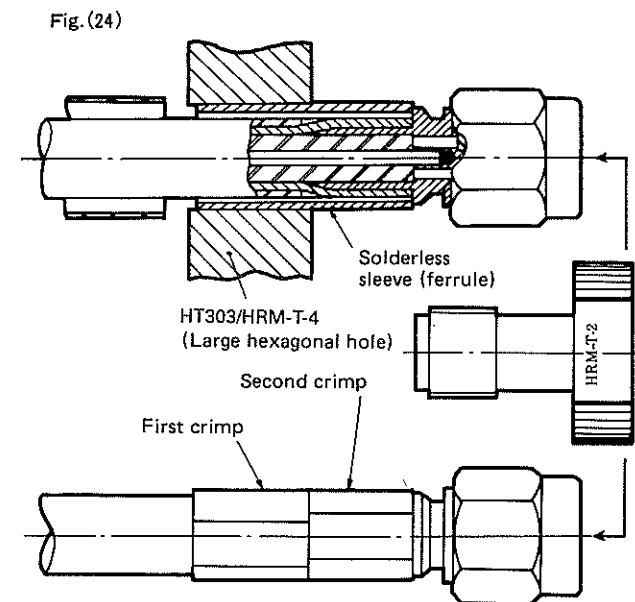

(4) Put on the boot over the ferrule (sleeve), and apply heat with a hair dryer or the like to cause shrinking.

When the connection of the wiring is completed, the appearance will be as shown in Fig. (25).

Note 1: When shrinking, catch the boot on the groove in the shell, as shown in Fig. (25).

Note 2: Remove HRM-T-2 (the locator) after shrinkage of the boot.

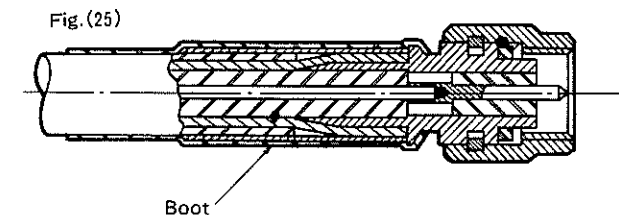

HRM SERIES RF CO-AXIAL CONNECTORS

5. HRM-204, 204S, 206, 206S

- (1) Process the cable ends
- i) Cut off 12.5mm of the outer covering of the cable (RG-142B/U)
Next cut off 4.5mm of the outer conductor, and also cut off 2.3mm of the insulation.

Note 1: When cutting the outer covering and insulation, be careful not to damage the outer conductor and the center conductor.

Note 2: Cut the cable insulation vertically and flatly.

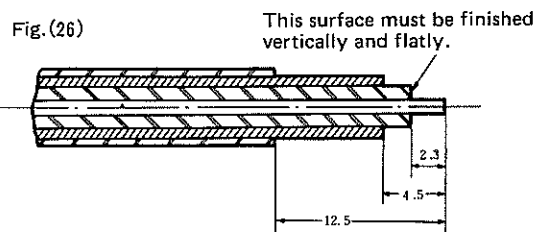

- (2) Solder the center conductor.
- Using HRM-T-6, solder the center conductor by the same procedure as in HRM-102 and HRM-103. (Refer to Fig. (27).)

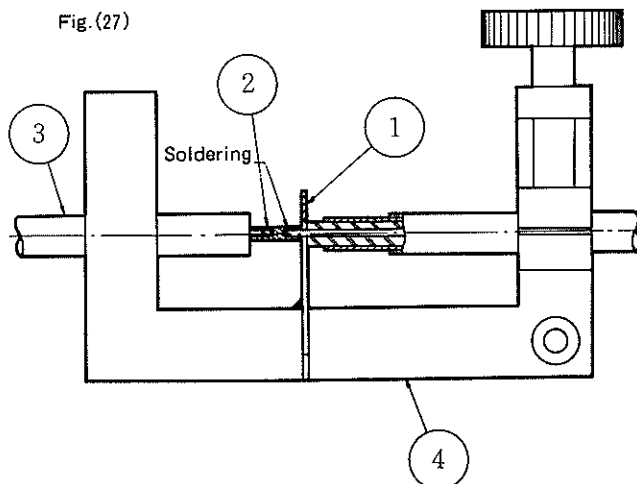

- (3) After passing the boot and ferrule (sleeve) over the cable, insert the cable through the connector-shell cord inlet, and crimp the ferrule (sleeve) in a hexagonal shape with HT303/HRM-T-4 (Refer to Fig. (28).)

i) To insert the cable, align the female contact with the hole in the insulation, and insert the connector shell between the insulation of the cable and the outer conductor.

ii) Insert the ferrule (sleeve) until it strikes against the uneven part of the shell, as shown in Fig. (28), and crimp it in a hexagonal shape with HT303/HRM-T-4

Note 1: Spread out the tip in order to make it easy to insert the outer conductor of the cable.

Note 2: Insertion of the cable is finished when the cable insulation strikes against the connector insulation. HRM-T-1 (the locator) is to be fitted in place in order to prevent the connector insulation from moving at this time.

Note 3: Crimping of the ferrule (sleeve) is performed first on the cable side and next on the connector side. (Be careful about the order; if the wrong order is followed, the clamping force will be reduced by one half.)

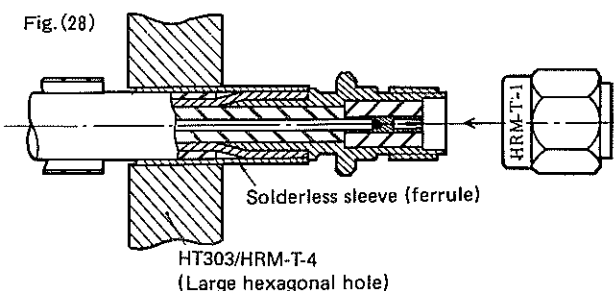

- (4) Put on the boot over the ferrule (sleeve), and apply heat with a hair dryer or the like to cause shrinking. When the connection of the wiring is completed, the appearance will be as shown in Fig. (29).

Note 1: When shrinking, catch the boot on the groove in the shell, as shown in Fig. (29).

Note 2: Remove HRM-T-1 (the locator) after shrinkage of the boot.

