

HS300x-MC1

High Performance Relative Humidity and Temperature Sensor Module

The HS300x-MC1 series module enables quick application integration with a standard 4-pin connector and fully calibrated relative humidity and temperature sensor (HS3001, HS3002, HS3003, or HS3004).

Integrated calibration and temperature-compensation logic provides fully corrected RH and temperature values via a standard I²C output. No user calibration of the output data is required.

The HS300x-MC1 is fully coated with HumiSeal for corrosion resistance.

Applications

- Climate control systems
- Home appliances
- Weather stations
- Industrial automation
- Medical equipment

Physical Characteristics

Supply voltage: 2.3V to 5.5V

- Extended supply voltage: 1.8V (-20°C to +125°C)
- Operating temperature (HS300x sensor): -40°C to +125°C
- Operating temperature (Module connector): -20°C to +85°C
- 16.0 × 24.0 × 6.5 mm module

Features

- Humidity range: 0% to 100%RH
- HumiSeal coating
- Humidity accuracy: ±1.5%RH, typical (HS3001-MC1, 10 to 90%RH, 25°C)
- 14-bit resolution: 0.01%RH, typical
- Independent programmable resolution settings: 8, 10, 12, 14 bits
- Fast RH response time: 1 second time constant, typical (with 1 m/sec air flow), 4 seconds time constant, typical (in still air)
- Temperature sensor accuracy: ±0.2°C, typical (HS3001, HS3002, -10 to +80°C)
- Low current consumption: 1.0µA average (8-bit resolution, 1.8V supply), 24.4µA average (14-bit resolution, 3.3V supply), one RH and temperature measurement per second
- Excellent stability against aging
- Highly robust protection from harsh environmental conditions and mechanical shock
- Very low power consumption

Product Image



Contents

1. Pin Information	4
1.1 Pin Assignments	4
1.2 Pin Descriptions	4
1.3 Pin Connector	4
2. Specifications	5
2.1 Absolute Maximum Ratings	5
2.2 Recommended Operating Conditions	5
3. Humidity and Temperature Specifications	6
3.1 Humidity Sensor Specification	6
3.2 Temperature Sensor Specification	7
3.3 Sleep Current	7
4. Typical Performance Graphs	8
4.1 Humidity Sensor Accuracy Graphs	8
4.2 Temperature Sensor Accuracy Graphs	10
5. Sensor Interface	10
5.1 I2C Features and Timing	10
5.2 Sensor Slave Address	11
5.3 I ² C Communication	11
5.4 Measurement Mode	12
5.5 Measurement Requests (MR)	12
5.6 Data Fetch (DF)	13
5.7 Status Bits	14
5.8 Accessing the Non-volatile Memory	14
5.9 Setting the Measurement Resolution	15
5.10 Reading the HS300x-MC1 ID Number	16
6. Calculating Humidity and Temperature Output	16
7. Application Circuit	16
8. Storage and Handling	16
9. Quality and Reliability	17
10. Package Outline Drawings	17
11. Ordering Information	18
12. Revision History	18

Figures

Figure 1. Sleep Current Variation over Temperature, V_{DD} at 3.3V.....	8
Figure 2. HS3001-MC1 RH Accuracy Tolerance at 25°C.....	8
Figure 3. HS3001-MC1 RH Accuracy over Temperature	8
Figure 4. HS3002-MC1 RH Accuracy Tolerance at 25°C.....	8
Figure 5. HS3002-MC1 RH Accuracy over Temperature	8
Figure 6. HS3003-MC1 RH Accuracy Tolerance at 25°C.....	9
Figure 7. HS3003-MC1 RH Accuracy over Temperature	9
Figure 8. HS3004-MC1 RH Accuracy Tolerance at 25°C.....	9
Figure 9. HS3004-MC1 RH Accuracy over Temperature	9
Figure 10. HS3001-MC1/HS3002-MC1 Temperature Sensor Accuracy Tolerance.....	10
Figure 11. HS3003-MC1 Temperature Sensor Accuracy Tolerance	10
Figure 12. HS3004-MC1 Temperature Sensor Accuracy Tolerance	10
Figure 13. Timing Diagram	11
Figure 14. START and STOP Condition Waveform.....	12
Figure 15. Measurement Request	12
Figure 16. Data Fetch.....	13
Figure 17. Sequence of Commands to Enter Programming Mode	14
Figure 18. Sequence of Commands to Change the Relative Humidity Resolution.....	15
Figure 19. HS300x-MC1 Application Circuit	16

Tables

Table 1. Absolute Maximum Ratings	5
Table 2. Recommended Operating Conditions.....	5
Table 3. Humidity Sensor Specification, $T_A = +25^\circ\text{C}$, $V_{DD} = 2.3\text{V}$ to 5.5V	6
Table 4. Temperature Sensor Specification, $T_A = +25^\circ\text{C}$, $V_{DD} = 2.3\text{V}$ to 5.5V	7
Table 5. I ² C Timing Parameters	11
Table 6. Status Bits	14
Table 7. Non-volatile Memory Registers.....	14
Table 8. Register Values for Different Resolution Settings.....	15

1. Pin Information

1.1 Pin Assignments

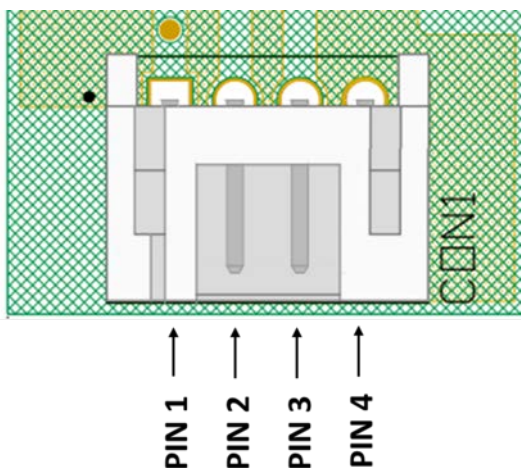

1.2 Pin Descriptions

Pin Number	Pin Name	Type	Description
1	VDD	In	Supply voltage
2	SCL	In/out	Serial clock
3	SDA	In/out	Serial data
4	VSS	In	Ground

1.3 Pin Connector

The 4-pin connector pitch is 0.079 inch (2.00mm). Part reference is JST, S4B-PH-K-S.

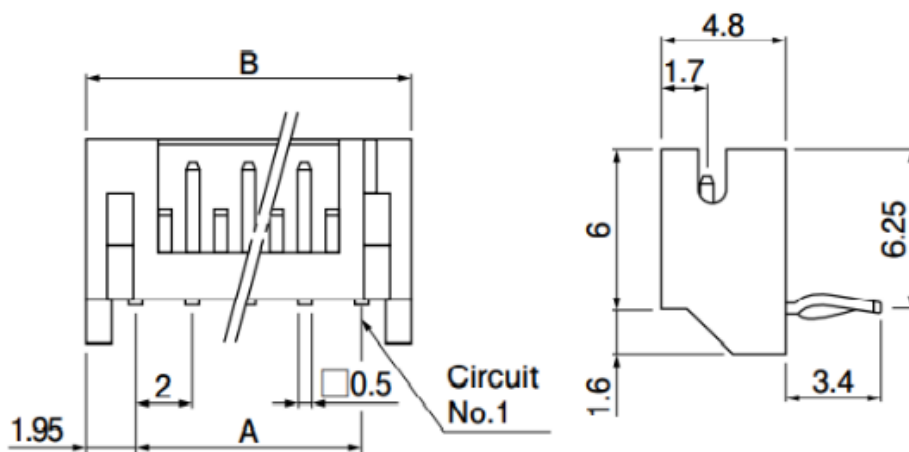

2. Specifications

2.1 Absolute Maximum Ratings

CAUTION: Do not operate at or near the maximum ratings listed for extended periods of time. Exposure to such conditions can adversely impact product reliability and result in failures not covered by warranty.

Table 1. Absolute Maximum Ratings

Symbol	Parameter	Conditions	Minimum	Maximum	Unit
	Analog Supply Voltage		-0.3	6.0	V
	Storage Temperature Range		-55	125	°C

2.2 Recommended Operating Conditions

Important note: The HS300x-MC1 series sensors are optimized to perform best in the more common temperature and humidity ranges of 10°C to 50°C and 20% RH to 80% RH, respectively. If operated outside of these conditions for extended periods, especially at high humidity levels, the sensors may exhibit an offset. In most cases, this offset is temporary and will gradually disappear once the sensor is returned to normal temperature and humidity conditions. The amount of the shift and the duration of the offset vary depending on the duration of exposure and the severity of the relative humidity and temperature conditions. The time needed for the offset to disappear can also be decreased by using the procedures described in “Storage and Handling”.

Table 2. Recommended Operating Conditions

Parameter	Condition		Minimum	Typical	Maximum	Unit
Operating Supply Voltage				3.3	5.5	V
Extended Operating Supply Voltage	Operating temperature from -20 to 125°C		1.8	-	5.5	V
Operating Humidity Range			0	-	100	%RH
Operating Temperature, Sensor	HS300x sensor only		-40	-	125	°C
Operating Temperature, Board	Limited to module connector		-20	-	85	°C
Sleep Current	Sleep Mode	-40 to 85°C	-	0.6	1	μA
		-40 to 125°C	-	1	3	
Average Current ^[1]	One RH + temperature measurement/second	8-bit resolution	1.0	1.5	1.7	μA
		10-bit resolution	2.0	2.6	2.8	
		12-bit resolution	5.5	7.0	7.1	
		14-bit resolution	20.1	24.4	24.4	
Measurement Time	Wake-up		-	0.10	-	ms
	Humidity or temperature including the digital compensation	8-bit resolution	-	0.55	-	
		10-bit resolution	-	1.31	-	
		12-bit resolution	-	4.50	-	
		14-bit resolution	-	16.90	-	

1. Minimum, typical, and maximum average currents are given at 1.8V, 3.3V, and 5.5V V_{DD} , respectively.

3. Humidity and Temperature Specifications

3.1 Humidity Sensor Specification

Table 3. Humidity Sensor Specification, $T_A = +25^{\circ}\text{C}$, $V_{DD} = 2.3\text{V}$ to 5.5V

Parameter	Condition		Minimum	Typical	Maximum	Unit
Operating Range			0		100	%RH
Accuracy ^[1]	HS3001-MC1	10% to 90%RH	-	±1.5	±1.8	%RH
	HS3002-MC1		-	±1.8	±2.0	
	HS3003-MC1	20% to 80%RH	-	±2.5	±3.5	
	HS3004-MC1		-	±3.5	±4.5	
Resolution	8-bit		-	0.7	1.0	%RH
	14-bit		-	0.01	0.015	
Hysteresis			-		±1.0	%RH
Noise in Humidity (RMS)	14-bit		-	0.014	-	%RH
Non-Linearity from Response Curve	HS3001-MC1	10% to 90%RH	-	±0.15	±0.25	%RH
	HS3002-MC1					
	HS3003-MC1	20% to 80%RH				
	HS3004-MC1					
Long-Term Stability			-	±0.1	±0.25	%RH/Yr
Response Time Constant ^[1] (τ_H)	20% to 80% RH, 1 meter/sec air flow		-	1	-	sec
	20% to 80% RH Still Air		3.0	4.0	6.0	

1. Monotonic increases from 10 to 90%RH after sensor has been stabilized at 50%RH.
2. Initial value to 63% of total variation.

3.2 Temperature Sensor Specification

Table 4. Temperature Sensor Specification, T_A = +25°C, V_{DD} = 2.3V to 5.5V

Parameter	Condition		Minimum	Typical	Maximum	Unit		
Range			-40		125	°C		
Accuracy	HS3001/3002-MC1	-10°C to 80°C	-	±0.2	±0.3	°C		
		-40°C to -10°C	-	±0.4	±0.5			
		80°C to 125°C	-	±0.5	±0.6			
	HS3003-MC1	0°C to 70°C	-	±0.25	±0.35			
		-10°C to 0°C	-	±0.3	±0.5			
		-20°C to -10°C	-	±0.35	±0.55			
		-30°C to -20°C	-	±0.4	±0.6			
		-40°C to -30°C	-	±0.55	±0.8			
		70°C to 125°C	-	±0.8	±1.0			
	HS3004-MC1	0°C to 70°C	-	±0.3	±0.5			
		-10°C to 0°C	-	±0.5	±0.8			
		-20°C to -10°C	-	±0.6	±1.0			
		-30°C to -20°C	-	±0.8	±1.3			
		-40°C to -30°C	-	±1.0	±1.5			
		70°C to 125°C	-	±1.5	±2.0			
	Resolution	8-bit		0.6	0.9		1.5	°C
		14-bit		0.01	0.015		0.025	
	Response Time Constant ^[1] (τ _T)			2..0	-		-	Sec.
Long-Term Stability			-	-	0.02	°C/Yr		
Supply Voltage Dependency ^[2]	VDD ≥ 2.8V		-	0.03	0.1	°C/V		
	1.8V < VDD < 2.8V		-	1.25	2.25	°C/V		

1. Response time depends on system thermal mass and air flow.
2. Temperature accuracy can be optimized for specified supply voltages upon request.

3.3 Sleep Current

The sleep current of the HS300x-MC1 series depends on the operating temperature, as shown in the following figure. Note that there is no significant dependence of the sleep current on the supply voltage.

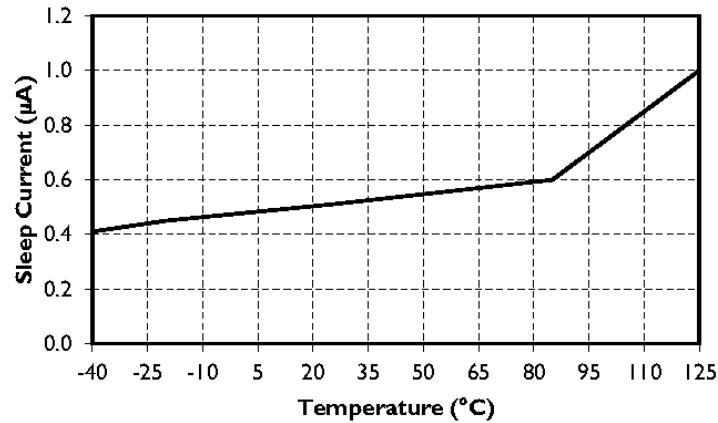

Figure 1. Sleep Current Variation over Temperature, V_{DD} at 3.3V

4. Typical Performance Graphs

4.1 Humidity Sensor Accuracy Graphs

The typical and maximum relative humidity sensor accuracy tolerances are shown in the following figures.

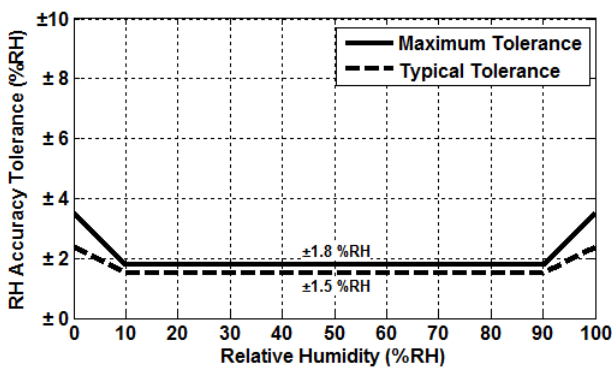

Figure 2. HS3001-MC1 RH Accuracy Tolerance at 25°C

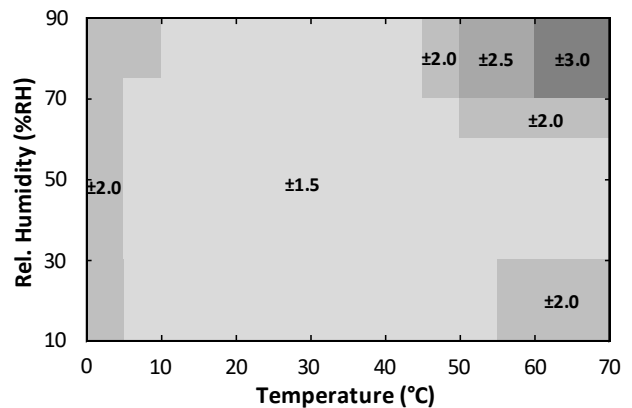

Figure 3. HS3001-MC1 RH Accuracy over Temperature

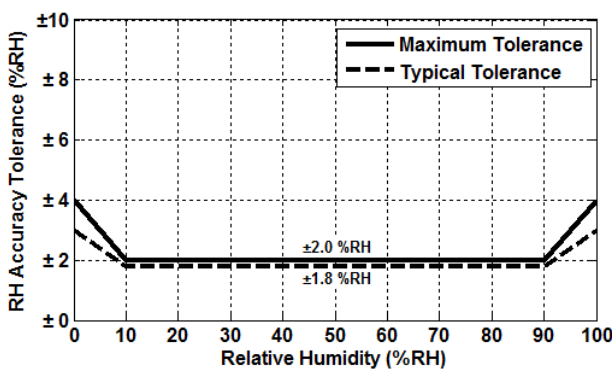

Figure 4. HS3002-MC1 RH Accuracy Tolerance at 25°C

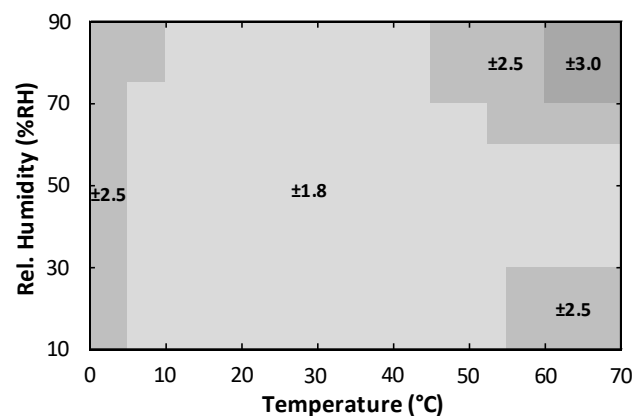

Figure 5. HS3002-MC1 RH Accuracy over Temperature

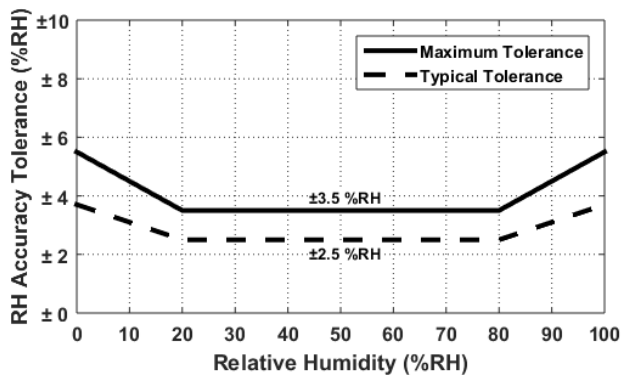

Figure 6. HS3003-MC1 RH Accuracy Tolerance at 25°C

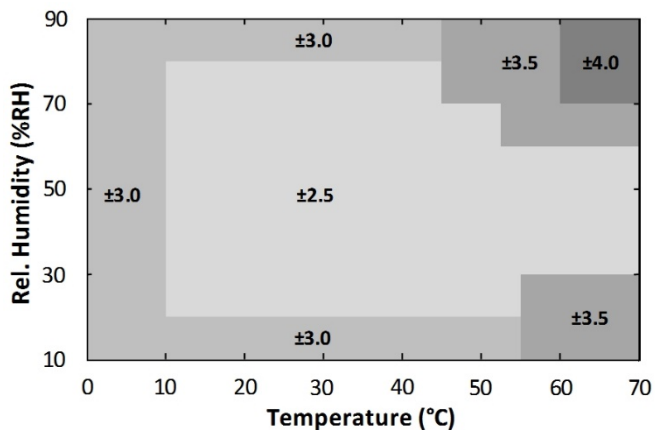

Figure 7. HS3003-MC1 RH Accuracy over Temperature

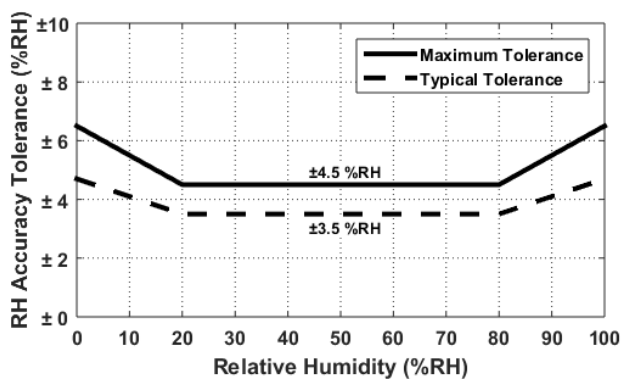

Figure 8. HS3004-MC1 RH Accuracy Tolerance at 25°C

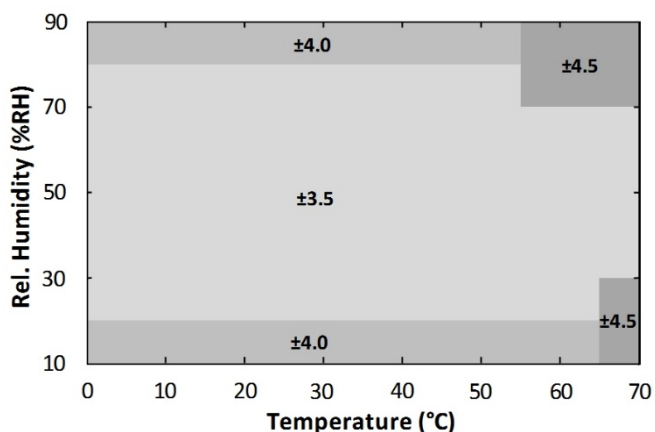

Figure 9. HS3004-MC1 RH Accuracy over Temperature

4.2 Temperature Sensor Accuracy Graphs

The typical and maximum temperature sensor accuracy tolerances are shown in the following figures.

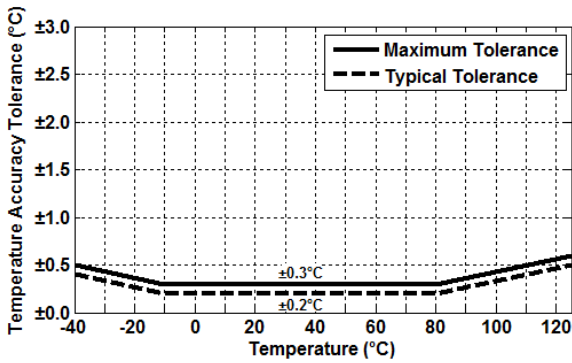

Figure 10. HS3001-MC1/HS3002-MC1 Temperature Sensor Accuracy Tolerance

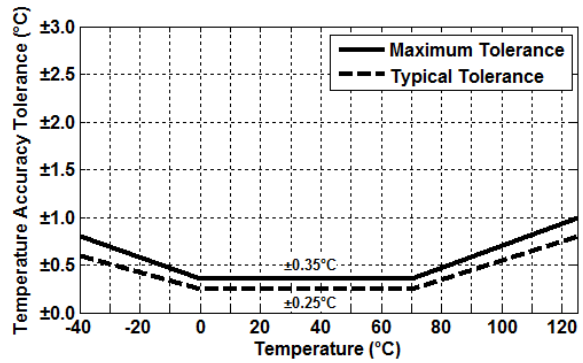

Figure 11. HS3003-MC1 Temperature Sensor Accuracy Tolerance

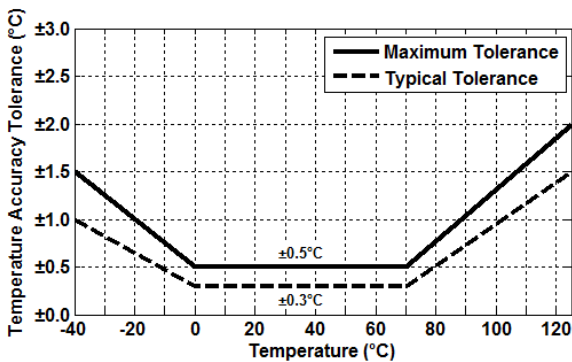

Figure 12. HS3004-MC1 Temperature Sensor Accuracy Tolerance

5. Sensor Interface

The HS300x-MC1 series sensor uses a digital I²C-compatible communication protocol. To accommodate multiple devices, the protocol uses two bi-directional open-drain lines: the Serial Data Line (SDA) and the Serial Clock Line (SCL). Pull-up resistors to V_{DD} are required. Several slave devices can share the bus; however only one master device can be present on the line.

5.1 I²C Features and Timing

The HS300x-MC1 series sensor operates as a slave device on the I²C bus with support for 100kHz and 400kHz bit rates. Each transmission is initiated when the master sends a 0 START bit (S), and the transmission is terminated when the master sends a 1 STOP bit (P). These bits are only transmitted while the SCL line is HIGH.

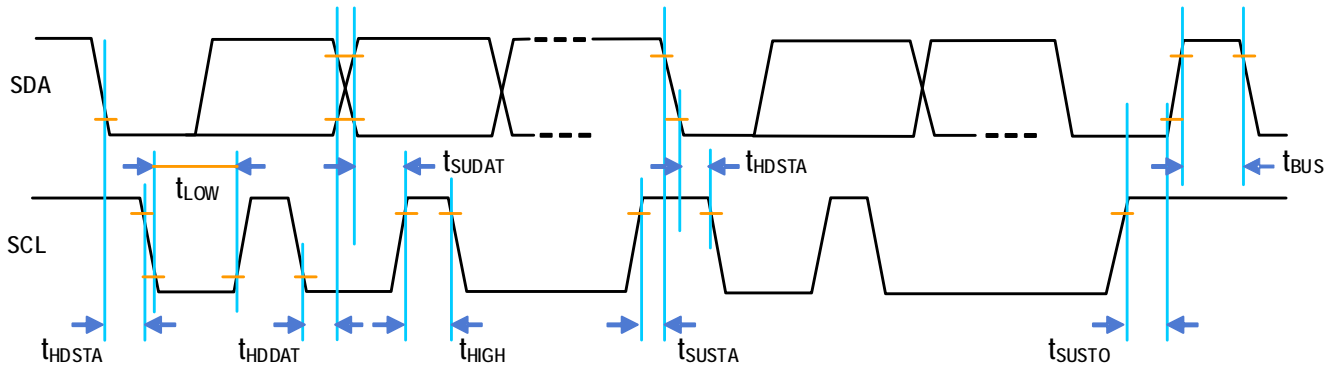

Figure 13. Timing Diagram

Table 5. I²C Timing Parameters

Parameter	Symbol	Minimum	Typical	Maximum	Unit
SCL Clock Frequency ^[1]	f_{SCL}	20	-	400	kHz
START Condition Hold Time Relative to SCL Edge	t_{HDSTA}	0.1	-	-	μs
Minimum SCL Clock LOW Width ^[2]	t_{LOW}	0.6	-	-	μs
Minimum SCL Clock HIGH Width ^[2]	t_{HIGH}	0.6	-	-	μs
START Condition Setup Time Relative to SCL Edge	t_{SUSTA}	0.1	-	-	μs
Data Hold Time on SDA Relative to SCL Edge	t_{HDDAT}	0	-	0.5	μs
Data Setup Time on SDA Relative to SCL Edge	t_{SUDAT}	0.1	-	-	μs
STOP Condition Setup Time on SCL	t_{SUSTO}	0.1	-	-	μs
Bus Free Time Between STOP Condition and START Condition	t_{BUS}	1	-	-	μs

1. The minimum frequency of 20kHz applies to test only; no minimum under normal operations.

2. Combined LOW and HIGH widths must equal or exceed the minimum SCL period.

5.2 Sensor Slave Address

The HS300x-MC1 series default I²C address is 44_{HEX}. The device will respond only to this 7-bit address. For more information, see “I²C Communication.”

Custom I²C address can be provided upon request.

5.3 I²C Communication

The sensor transmission is initiated when the master sends a 0 START bit (S). The transmission is terminated when the master sends a 1 STOP bit (P). These bits are only transmitted while the SCL line is HIGH (see Figure 14 for waveforms).

When the START condition has been set, the SCL line is toggled at the prescribed data rate, clocking subsequent data transfers. Data on the SDA line is always sampled on the rising edge of the SCL line and must remain stable while SCL is HIGH to prevent false START or STOP conditions.

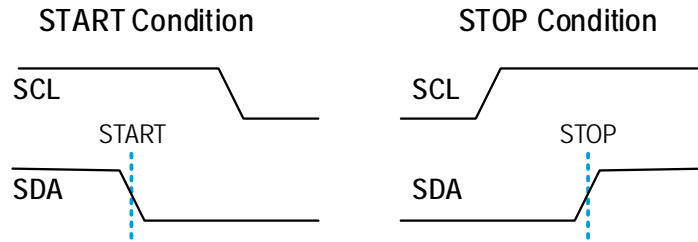

Figure 14. START and STOP Condition Waveform

After the START bit, the master device sends the 7-bit slave address (see “Sensor Slave Address”) to the HS300x-MC1, followed by the read/write bit, which indicates the transfer direction of any subsequent data. This bit is set to 1 to indicate a read from slave to master or set to 0 to indicate a write from master to slave.

All transfers consist of 8 bits and a response bit: 0 for Acknowledge (ACK) or 1 for Not Acknowledge (NACK). After the ACK is received, another data byte can be transferred or the communication can be stopped with a STOP bit.

5.4 Measurement Mode

The HS300x-MC1 is factory-programmed to operate in Sleep Mode. In Sleep Mode, the sensor waits for commands from the master before taking measurements. The digital core only performs conversions when it receives a *Measurement Request* command (MR); otherwise, it is always powered down.

5.5 Measurement Requests (MR)

The MR command is required to wake up the HS300x-MC1 from its Sleep Mode. Initiate the Measurement Request by sending the 7-bit slave address followed by an eighth bit = 0 (WRITE).

A measurement cycle consists of a humidity and temperature conversion followed by the digital signal processor (DSP) correction calculations. At the end of a measurement cycle, the digital output register will be updated before powering down.

The output is always scaled to 14 bits. The order of the bits is big-endian.

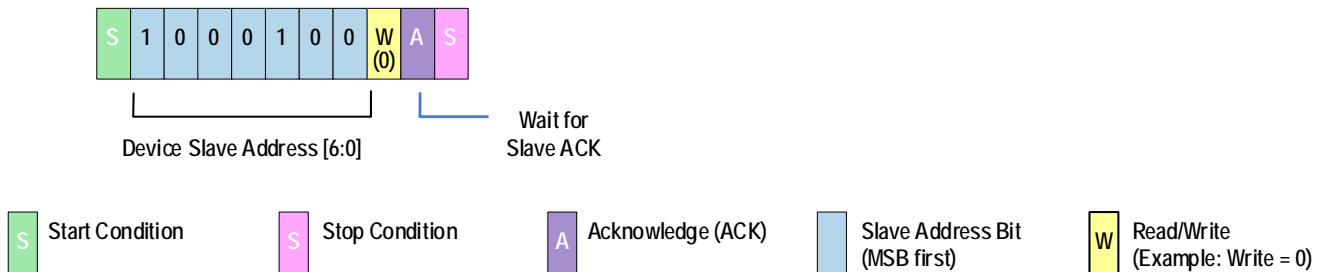

Figure 15. Measurement Request

5.6 Data Fetch (DF)

At the end of a measurement cycle, valid data can be fetched. The status bits of the DF results can be used to detect if the data is valid or stale (see “Status Bits”); otherwise, wait for the measurements to complete before performing the DF.

The DF command starts with the 7-bit slave address followed by an eighth bit = 1 (READ). The HS300x-MC1 as a slave sends an acknowledge (ACK) indicating success.

The number of data bytes returned by the HS300x-MC1 is determined by when the master sends the NACK and STOP condition. The full 14 bits of the humidity data are fetched in the first two bytes. The two MSBs of the first byte are the status bits.

The 14 bits of temperature data follow the humidity data. The last two bits (LSBs) of the fourth data byte are undetermined and should be masked off. In the event that the temperature data is not needed, the read can be terminated by sending a NACK after the second byte.

Alternatively, if only 8-bit resolution is desired for the temperature output, the read can be terminated after the 3rd byte by issuing a NACK followed by a stop bit. The measurement time depends on the configured sensor resolution. The following table lists examples when the resolutions for the relative humidity and temperature measurements are the same. For different relative humidity and temperature resolution settings, the measurement times in 3 should be used, along with the 0.1ms wake-up time.

For example, an 8-bit relative humidity measurement and a 12-bit temperature measurement results in a total measurement time of:

$$0.1 \text{ ms} + 0.55 \text{ ms} + 4.5 \text{ ms} = 5.15 \text{ ms.}$$

RH+T measurement times (including wake-up time) at different resolution settings.

Resolution ^[1] (Bits)	Measurement Time (ms)
8	1.20
10	2.72
12	9.10
14	33.90

1. Same resolutions are assumed for both relative humidity and temperature.

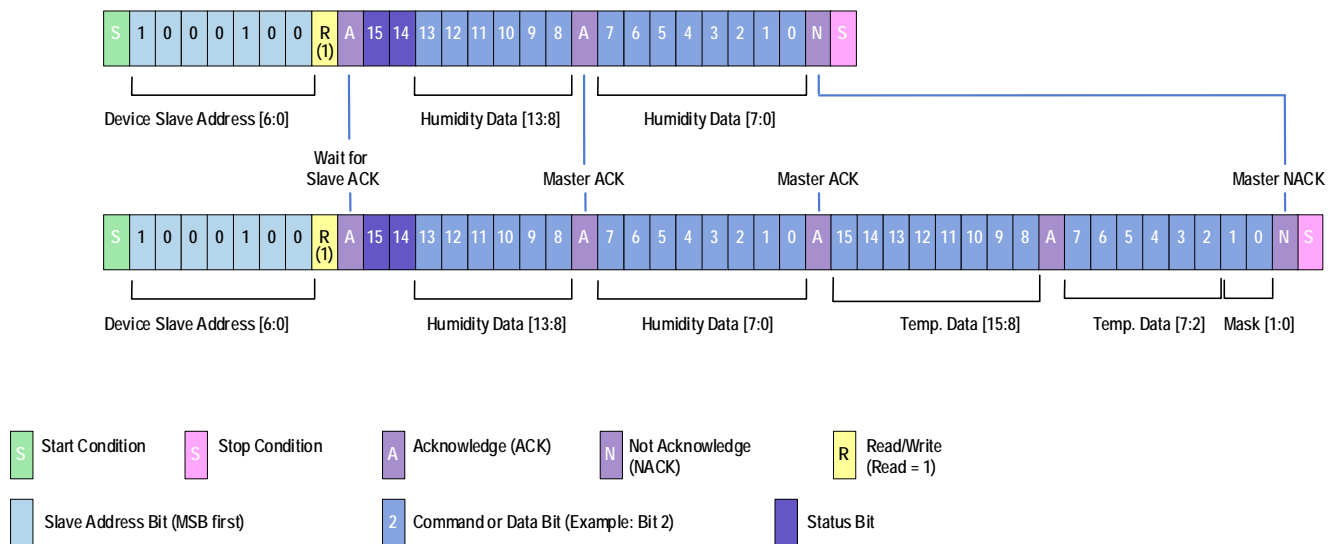

Figure 16. Data Fetch

5.7 Status Bits

The status bits are used to indicate the current state of the fetched data. The two MSBs of the humidity data byte are the status bits (see the following table).

Table 6. Status Bits

Status Bits	Definition
00 _B	Valid Data: Data that has not been fetched since the last measurement cycle.
01 _B	Stale Data: Data that has already been fetched since the last measurement cycle. <i>Note:</i> If a data fetch is performed before or during the first measurement after power-on reset, then the stale status will be returned, but this data is actually invalid since the first measurement has not been completed.

5.8 Accessing the Non-volatile Memory

The HS300x-MC1 series non-volatile memory stores its measurement resolution setting and its ID number. To change the sensor resolution or read the ID number, the master must place the HS300x-MC1 into programming mode while the device is powering up. The following figure shows the sequence of commands needed to enter the programming mode, which must be sent within 10ms after applying power to the sensor. The master must send the I²C address and a Write bit followed by the command **0xA0|0x00|0x00**.

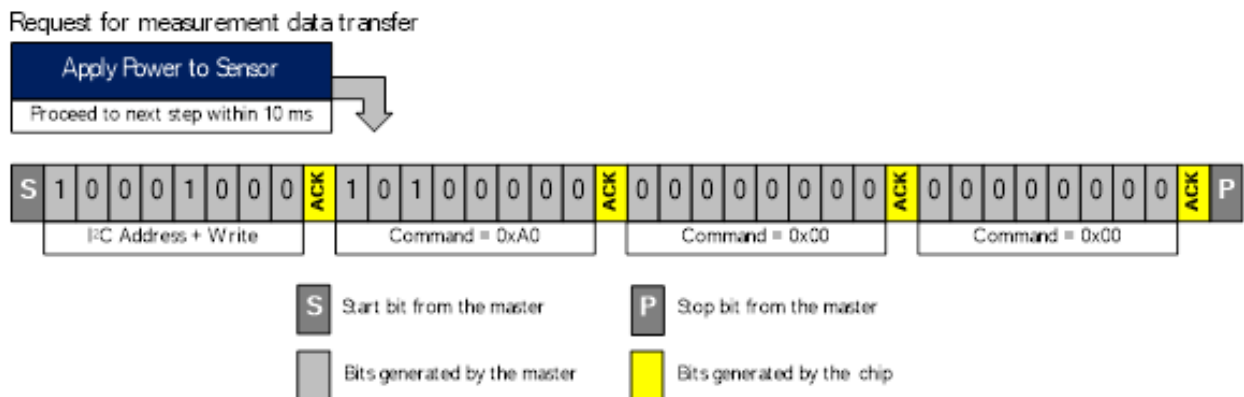

Figure 17. Sequence of Commands to Enter Programming Mode

This command takes 120µs to process, after which the master has access to the non-volatile memory registers listed in the following table. All of these registers are 16 bits wide.

To return to normal sensor operation and perform measurements, the master must send the I²C address and a Write bit, followed by the command: **0x80|0x00|0x00**.

Table 7. Non-volatile Memory Registers

Address	Register Description
0x06	Humidity Sensor Resolution – Read Register (bits [11:10])
0x46	Humidity Sensor Resolution – Write Register (bits [11:10])
0x11	Temperature Sensor Resolution – Read Register (bits [11:10])
0x51	Temperature Sensor Resolution – Write Register (bits [11:10])
0x1E	Read Sensor ID – Upper 2 bytes
0x1F	Read Sensor ID – Lower 2 bytes

5.9 Setting the Measurement Resolution

The HS300x-MC1 series relative humidity and temperature measurement resolutions can be set *independently* to 8, 10, 12, or 14-bits by writing to the non-volatile memory, and are initially set to **14 bits by default**. The procedure to set the humidity sensor resolution is illustrated in the following figure. The relative humidity and temperature resolution can be read in registers **0x06 and 0x11**, respectively, or written in registers **0x46 or 0x51**. The resolution information is stored in bits [11:10] of these registers, as listed in Table 8. All of the other bits in these registers must be left unchanged. As such, before writing new resolution settings, the contents of the read registers must be read, and only bits [11:10] can be changed in the write registers. Once bits [11:10] are changed to set the desired resolution, *the entire register must be written back* to the HS300x-MC1 sensor.

Step 1

Write the register address



Step 2

Read the register contents

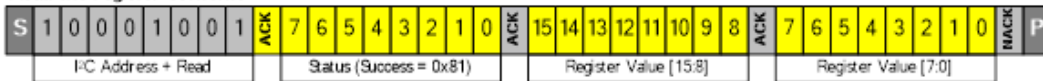

Step 3

Change bits [11:10] of the register to the desired resolution setting, *without changing the other bits*

Step 4

Write the register contents back

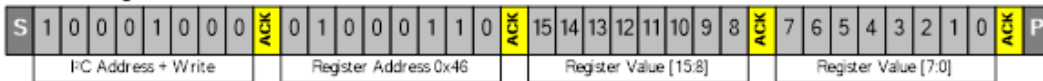

Figure 18. Sequence of Commands to Change the Relative Humidity Resolution

Table 8. Register Values for Different Resolution Settings

Resolution Register Bits [11:10]	Resolution (Bits)
00 _B	8
01 _B	10
10 _B	12
11 _B	14

The sensor non-volatile memory requires 120µs to load the data into the registers after step 1, and requires 14ms to write the data after step 4. *Failure to comply with these processing times may result in data corruption and introduce errors in sensor measurements.* The procedure to change the temperature sensor resolution is the same as that displayed in Figure 19, except the register address in Step 1 must be set to **0x11** and the register address in Step 4 will be **0x51**.

5.10 Reading the HS300x-MC1 ID Number

The sensor ID is a 32-bit number and can be read in a similar fashion as illustrated in steps 1 and 2 of Figure 19, using the appropriate register address values. The ID number is stored in two registers, with the upper and lower 16 bits stored in register addresses **0x1E** and **0x1F**, respectively.

6. Calculating Humidity and Temperature Output

The entire output of the HS300x-MC1 is 4 bytes. The relative humidity (in percent) and the temperature (in degrees Celsius) are calculated with Equation 1 and Equation 2, respectively.

$$Humidity [\%RH] = \left(\frac{Humidity [13 : 0]}{2^{14} - 1} \right) * 100 \quad \text{Equation 1}$$

$$Temperature [^{\circ}C] = \left(\frac{Temperature [15 : 2]}{2^{14} - 1} \right) * 165 - 40 \quad \text{Equation 2}$$

7. Application Circuit

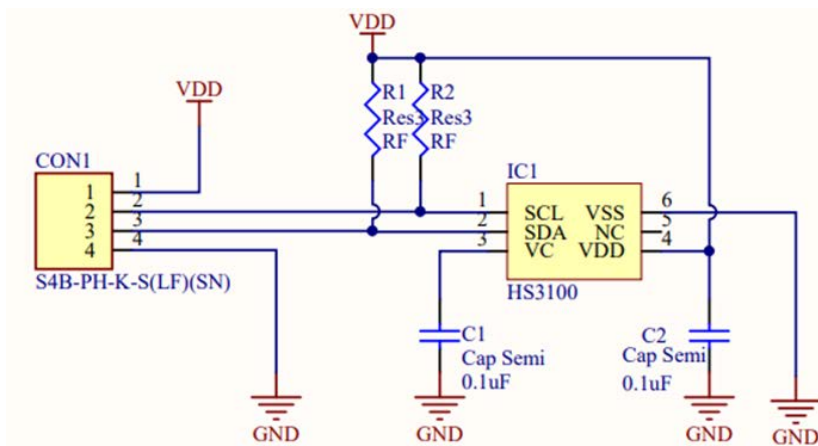

Figure 19. HS300x-MC1 Application Circuit

8. Storage and Handling

Recommendation: Once the sensors are removed from their original packaging, store them in metal-in antistatic bags.

Avoid using polyethylene antistatic bags as they may affect sensor accuracy.

The nominal storage conditions are 10°C to 50°C and humidity levels within 20% to 60%RH. If stored outside of these conditions for extended periods of time, the sensor readings may exhibit an offset. The sensor can be reconditioned and brought back to its calibration state by applying the following procedure:

1. Bake at a temperature of 80°C with a humidity < 10%RH for 10 to 12 hours.
2. Rehydrate the sensor at a humidity of 75%RH and a temperature between 20°C to 30°C for 12 to 14 hours.

9. Quality and Reliability

The HS300x-MC1 series is available as a qualified product for consumer and industrial market applications. All data specified parameters are confirmed if not stated otherwise.

10. Package Outline Drawings

The package outline drawings include the following.

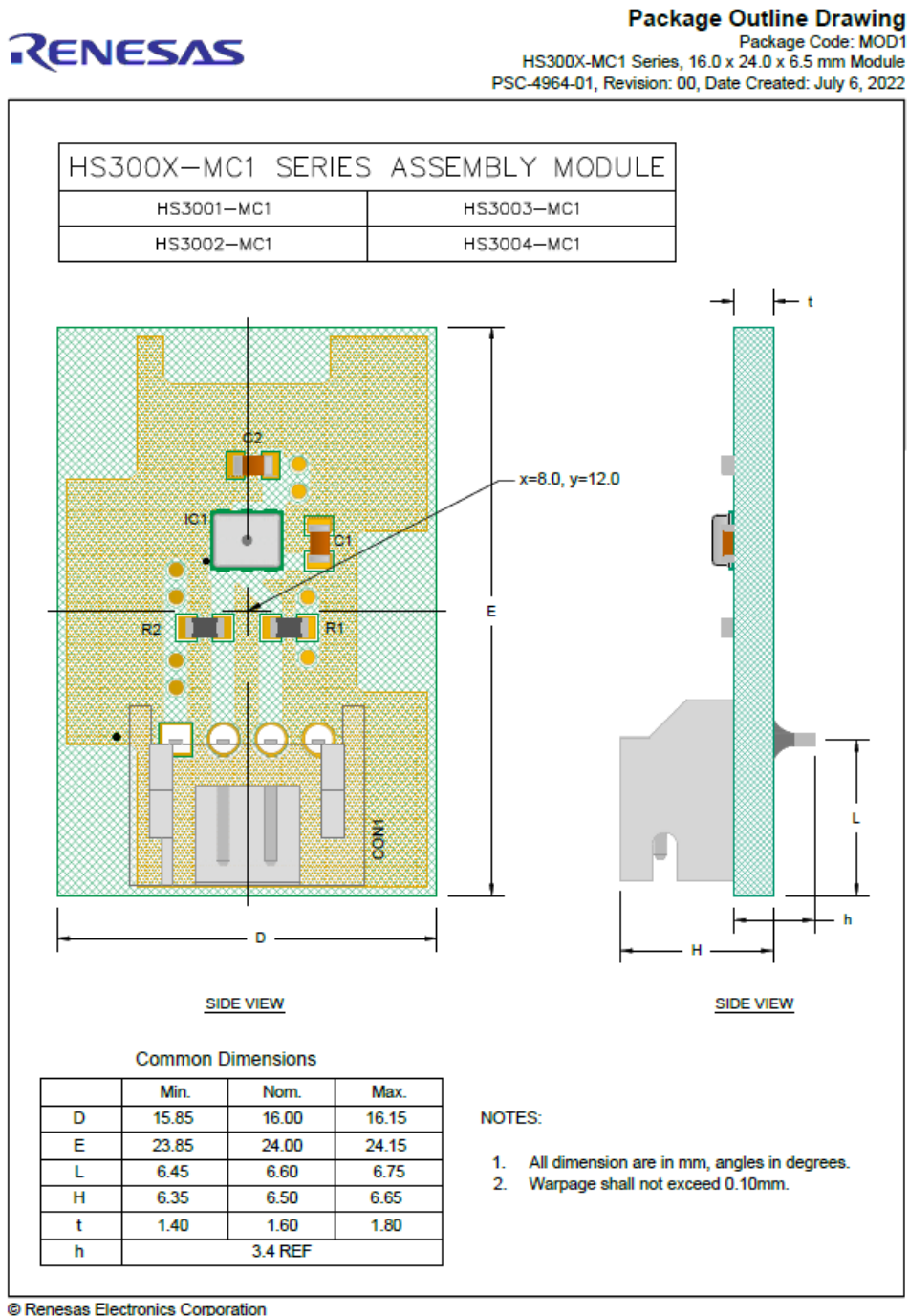

11. Ordering Information

Part Number	Description and Package	Carrier Type	Temp. Range
HS3001-MC1	Digital Relative Humidity and Temperature Sensor. ±1.5%RH (Typical), 16.0 × 24.0 × 6.5 mm module	Tray	-20°C to +85°C
HS3002-MC1	Digital Relative Humidity and Temperature Sensor. ±1.8%RH (Typical), 16.0 × 24.0 × 6.5 mm module	Tray	-20°C to +85°C
HS3003-MC1	Digital Relative Humidity and Temperature Sensor. ±2.5%RH (Typical), 16.0 × 24.0 × 6.5 mm module	Tray	-20°C to +85°C
HS3004-MC1	Digital Relative Humidity and Temperature Sensor. ±3.5%RH (Typical), 16.0 × 24.0 × 6.5 mm module	Tray	-20°C to +85°C

12. Revision History

Revision	Date	Description
1.01	Jul 12, 2022	Expanded Table 4, temperature specification. Updated Package Outline Drawings diagram.
1.00	Nov 9, 2021	Initial release.