

## HS411x

High Performance Relative Humidity and Temperature Sensor with Membrane and Analog Output

The HS411x series is a highly accurate, fully calibrated automotive-grade relative humidity and temperature sensor with a hydrophobic membrane. The membrane makes the HS411x dust resistant and waterproof. The MEMS sensor features a proprietary sensor-level protection, ensuring high reliability and long-term stability.

The high accuracy, fast measurement response time, and long-term stability combined with the small package size makes the HS411x series ideal for a wide number of applications ranging from portable devices to products designed for harsh environments.

The HS411x series digital sensor accurately measures relative humidity and temperature levels. The measured data is internally corrected and compensated for accurate operation over a wide range of temperature and humidity levels – user calibration is not required.

The HS411x series are digital sensors at their core. Measurements are then converted to ratio-metric analog output. This makes the HS411x suitable for high-noise environment applications.

### Physical Characteristics

- Supply voltage: 1.71V to 3.6V
- Operating temperature: -40°C to +105°C
- 2.5 × 2.5 × 0.9 mm DFN-style 8-LGA package

### Features

- Humidity range: 0% to 100%RH
- Automotive grade, AEC-Q100 qualified, Grade 2, -40°C to +105°C
- Industrial grade, JEDEC qualified, -40°C to +105°C
- Hydrophobic membrane, IP67 rating
- 10% to 90% ratio-metric analog output voltage
- RH accuracy: ±1.5% RH, typical (HS4111)
- Fast RH response time: 4 seconds time constant, typical
- Temperature sensor accuracy: ±0.2°C, typical (HS4111, -10 to +80°C)
- Very low current consumption: 92µA average (3.3V supply)
- Excellent stability against aging and volatile compounds
- Highly robust protection from harsh environmental conditions and mechanical shock

### Applications

- Climate control systems
- Instrumentation
- Home appliances
- Weather stations
- Building automation
- HVAC systems
- Medical equipment
- Data logging systems

### Product Image

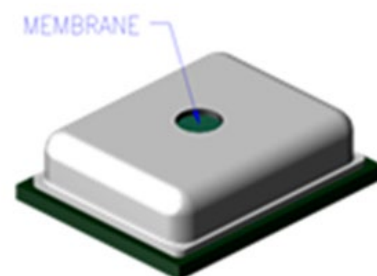

## Contents

<b>1. Pin Information</b>	<b>4</b>
1.1 Pin Assignments	4
1.2 Pin Descriptions	4
<b>2. Specifications</b>	<b>5</b>
2.1 Absolute Maximum Ratings	5
2.2 Recommended Operating Conditions	5
<b>3. Humidity and Temperature Sensor Performance</b>	<b>6</b>
3.1 Humidity Sensor Specifications	6
3.2 Temperature Sensor Specifications	6
3.3 Humidity Sensor Accuracy Graphs	7
3.4 Temperature Sensor Accuracy Graphs	7
<b>4. Sensor Startup</b>	<b>8</b>
<b>5. Application Circuit</b>	<b>8</b>
<b>6. Converting Output Signal</b>	<b>8</b>
<b>7. Soldering Information</b>	<b>10</b>
<b>8. PCB Layout Guide</b>	<b>11</b>
<b>9. Storage and Handling</b>	<b>11</b>
<b>10. Quality and Reliability</b>	<b>11</b>
<b>11. Package Outline Drawings</b>	<b>12</b>
<b>12. Ordering Information</b>	<b>12</b>
<b>13. Revision History</b>	<b>12</b>

## List of Figures

Figure 1. HS4111 RH Accuracy Tolerance at 25°C .....	7
Figure 2. HS4111 RH Accuracy over Temperature.....	7
Figure 3. HS4113 RH Accuracy Tolerance at 25°C .....	7
Figure 4. HS4113 RH Accuracy over Temperature.....	7
Figure 5. HS4111 Temperature Sensor Accuracy Tolerance .....	7
Figure 6. HS4113 Temperature Sensor Accuracy Tolerance .....	7
Figure 7. HS411x Application Circuit.....	8
Figure 8. Relative Humidity vs. VRH Output Analog Voltage.....	9
Figure 9. Temperature vs. VT Output Analog Voltage .....	9
Figure 10. Recommended Soldering Profile.....	10
Figure 11. Milled PCB Openings for Thermal Isolation .....	11

## List of Tables

Table 1. Humidity Sensor Specifications, $T_A = +25^\circ\text{C}$ , $V_{DD} = 1.71\text{V}$ to $3.6\text{V}$ .....	6
Table 2. Temperature Sensor Specifications, $T_A = +25^\circ\text{C}$ , $V_{DD} = 1.71\text{V}$ to $3.6\text{V}$ .....	6

# 1. Pin Information

## 1.1 Pin Assignments

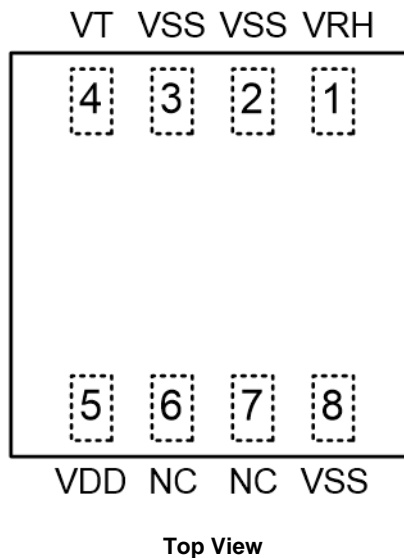

## 1.2 Pin Descriptions

Pin Number	Pin Name	Type	Description
1	VRH <sup>[1]</sup>	Out	Analog RH output voltage.
2	VSS	In	Ground.
3	VSS	In	Ground.
4	VT <sup>[1]</sup>	Out	Analog temperature output voltage.
5	VDD	In	Supply voltage.
6	NC <sup>[2]</sup>	-	Do not connect.
7	NC <sup>[2]</sup>	-	Do not connect.
8	VSS	In	Ground.

1. VRH and VT requires a capacitor (see Application Circuit).
2. "NC" stands for not connected / no connection required / not bonded.

## 2. Specifications

### 2.1 Absolute Maximum Ratings

**Caution:** The absolute maximum ratings are stress ratings only. Stresses greater than those listed below can cause permanent damage to the device. Functional operation of the HS411x at absolute maximum ratings is not implied. Exposure to absolute maximum rating conditions might affect device reliability.

Parameter	Conditions	Minimum	Maximum	Unit
Supply Voltage	-	-	3.6	V
Storage Temperature Range	Recommended 0 to 60°C	-40	125	°C

### 2.2 Recommended Operating Conditions

Important note: The HS411x series sensors are optimized to perform best in the more common temperature and humidity ranges of 10°C to 50°C and 20% RH to 80% RH, respectively. If operated outside of these conditions for extended periods, especially at high humidity levels, the sensors may exhibit an offset. In most cases, this offset is temporary and will gradually disappear once the sensor is returned to normal temperature and humidity conditions. The amount of the shift and the duration of the offset vary depending on the duration of exposure and the severity of the relative humidity and temperature conditions.<sup>[1]</sup> The time needed for the offset to disappear can also be decreased by using the procedures described in sections 9 and 10.

Parameter	Condition	Minimum	Typical	Maximum	Unit
Operating Supply Voltage	-	1.71	3.3	3.6	V
Average Current	V <sub>DD</sub> = 1.8V	-	82	95	μA
	V <sub>DD</sub> = 3.3V	-	92	110	
Measurement Time	Humidity and temperature measurement	-	1.7	2.3	ms
Operating Temperature Range	-	-40	-	105	°C

1. At T<sub>A</sub> = +25°C, V<sub>DD</sub> = +1.71V to +3.6V unless otherwise noted

### 3. Humidity and Temperature Sensor Performance

#### 3.1 Humidity Sensor Specifications

Table 1. Humidity Sensor Specifications, T<sub>A</sub> = +25°C, V<sub>DD</sub> = 1.71V to 3.6V

Parameter	Condition		Minimum	Typical	Maximum	Unit
Range	-		0	-	100	%RH
Accuracy <sup>[1][2]</sup>	HS4111	10% to 90% RH	-	±1.5	±1.8	%RH
	HS4113	20% to 80% RH	-	±2.5	±3.5	
Resolution	14-bit		-	0.04	0.05	%RH
Hysteresis	-		-	-	±1.0	%RH
Non-Linearity from Response Curve	HS4111	10% to 90% RH	-	±0.15	±0.25	%RH
	HS4113	20% to 80% RH				
Long-Term Stability	-		-	±0.1	±0.25	%RH/Yr
Response Time Constant <sup>[3]</sup> (τ <sub>H</sub> )	20% to 80% RH Still Air		3.0	4.0	6.0	sec

1. Monotonic increases from 10 to 90% RH after sensor has been stabilized at 50% RH.
2. Refer to section 3.3 for additional details.
3. Initial value to 63% of total variation. Response time depend on system airflow.

#### 3.2 Temperature Sensor Specifications

Table 2. Temperature Sensor Specifications, T<sub>A</sub> = +25°C, V<sub>DD</sub> = 1.71V to 3.6V

Parameter	Condition		Minimum	Typical	Maximum	Unit
Range	-		-40	-	105	°C
Accuracy <sup>[1]</sup>	HS4111	-10°C to 80°C	-	±0.2	±0.3	°C
	HS4113	0°C to 70°C	-	±0.25	±0.35	
Resolution	-		-	0.01	0.02	°C
Response Time Constant <sup>[2]</sup> (τ <sub>T</sub> )	-		-	>2.0	-	sec
Long-Term Stability	-		-	-	0.03	°C/Yr
Supply Voltage Dependency <sup>[3]</sup>	-		-	0.03	0.1	°C/V

1. Response time depends on system thermal mass (e.g. PCB dimensions and thickness) and airflow Refer to section 3.4 for additional details.
2. Initial value to 63% of total variation. Response time depends on system thermal mass and air flow.
3. Temperature accuracy can be optimized for specified supply voltages upon request.

### 3.3 Humidity Sensor Accuracy Graphs

The typical and maximum relative humidity sensor accuracy tolerances are shown in the following figures.

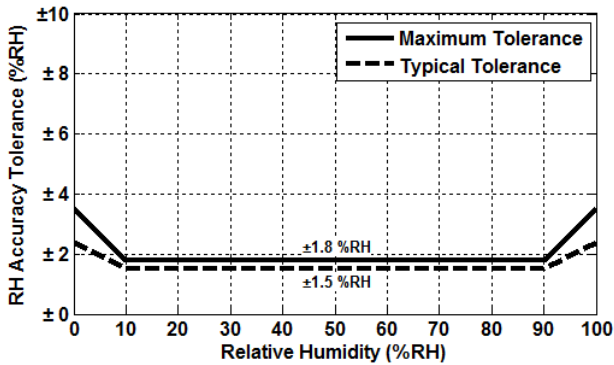

Figure 1. HS4111 RH Accuracy Tolerance at 25°C

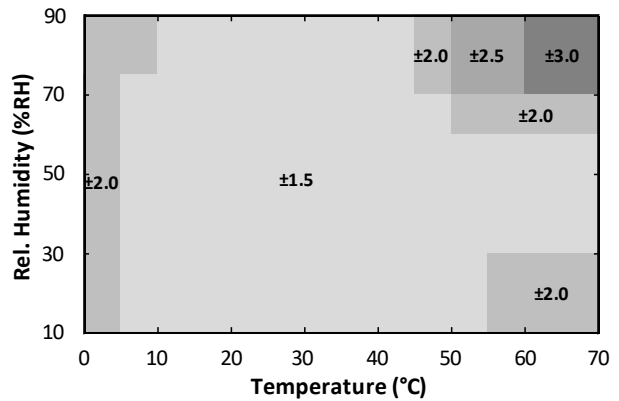

Figure 2. HS4111 RH Accuracy over Temperature

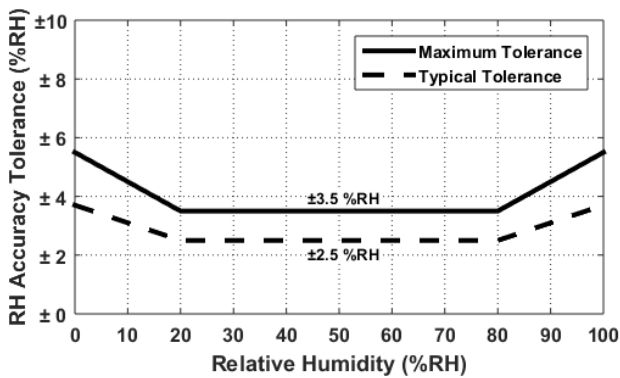

Figure 3. HS4113 RH Accuracy Tolerance at 25°C

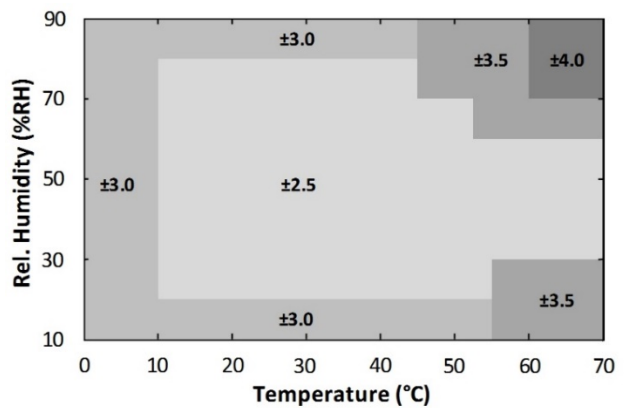

Figure 4. HS4113 RH Accuracy over Temperature

### 3.4 Temperature Sensor Accuracy Graphs

The typical and maximum temperature sensor accuracy tolerances are shown in the following figures.

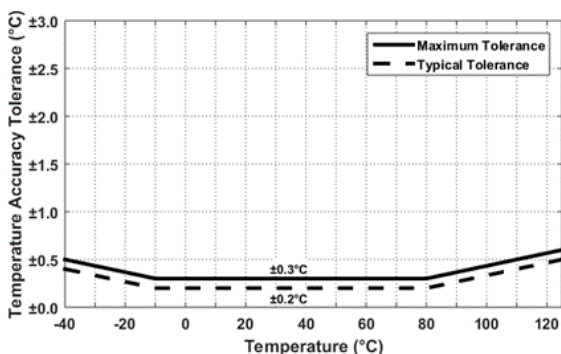

Figure 5. HS4111 Temperature Sensor Accuracy Tolerance

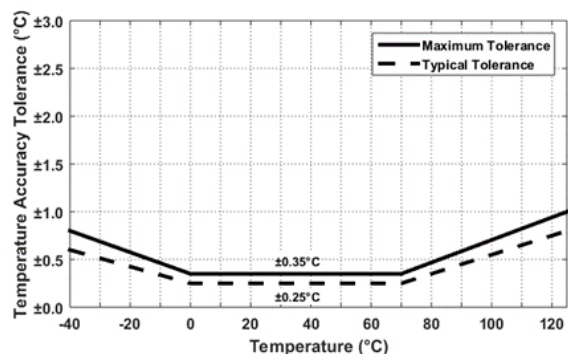

Figure 6. HS4113 Temperature Sensor Accuracy Tolerance

## 4. Sensor Startup

The HS411x sensor requires a typical 100ms to start up, after which temperature and relative humidity measurement data will be provided on the corresponding pins.

## 5. Application Circuit

The HS411x sensor requires a 2.2µF ceramic capacitor connected to the ground on both the VRH and VT outputs. It is also recommended to buffer the output of the relative humidity and temperature signals before processing the analog voltage. The buffer should have a low input leakage current, < 1nA, and a low input offset voltage, < 1mV, to ensure high signal integrity.

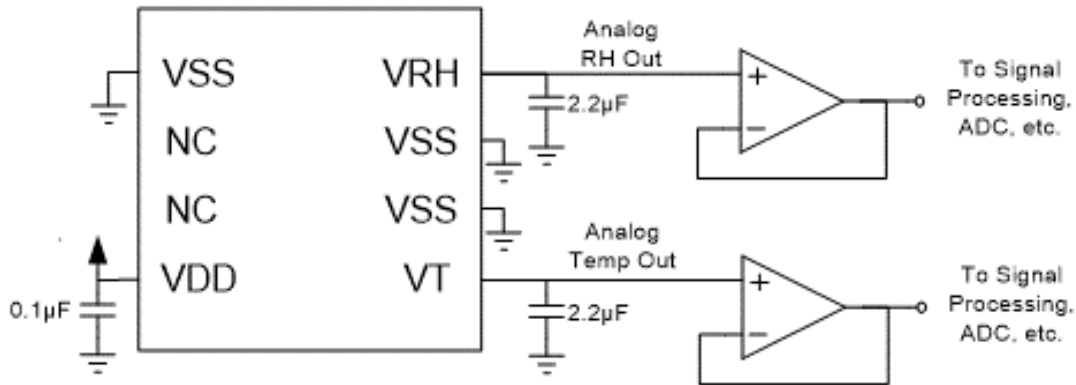

Figure 7. HS411x Application Circuit

## 6. Converting Output Signal

The voltage levels of the filtered analog output signal are ratio-metric with  $V_{DD}$ . The default output range for the relative humidity and temperature is from 10% to 90%.

Each HS411x sensor is individually calibrated, so that a standard linear fitting equation can be used to obtain the measured temperature and RH value.

Figure 8 and Figure 9 shows the RH and temperature graphically.

The relative humidity (in percent) and the temperature (in degrees Celsius) are calculated with Equation 1 and Equation 2, respectively.

$$\text{Humidity } [\%RH] = 125 * \frac{VRH}{VDD} - 12.5 \quad \text{Equation 1}$$

$$\text{Temperature } [^{\circ}C] = 181.25 * \frac{VT}{VDD} - 58.125 \quad \text{Equation 2}$$



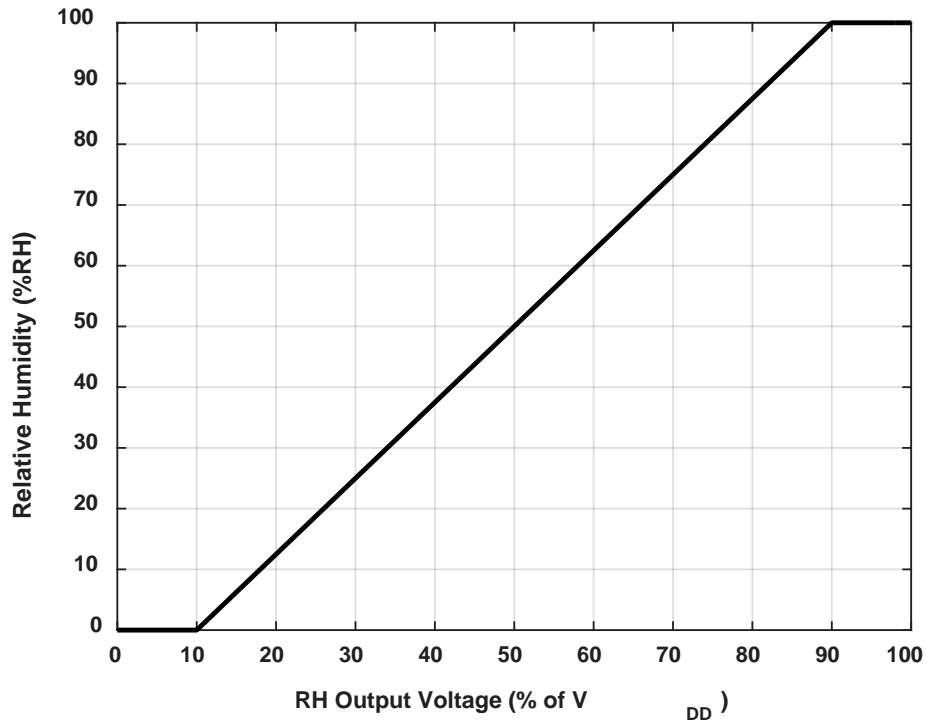

Figure 8. Relative Humidity vs. VRH Output Analog Voltage

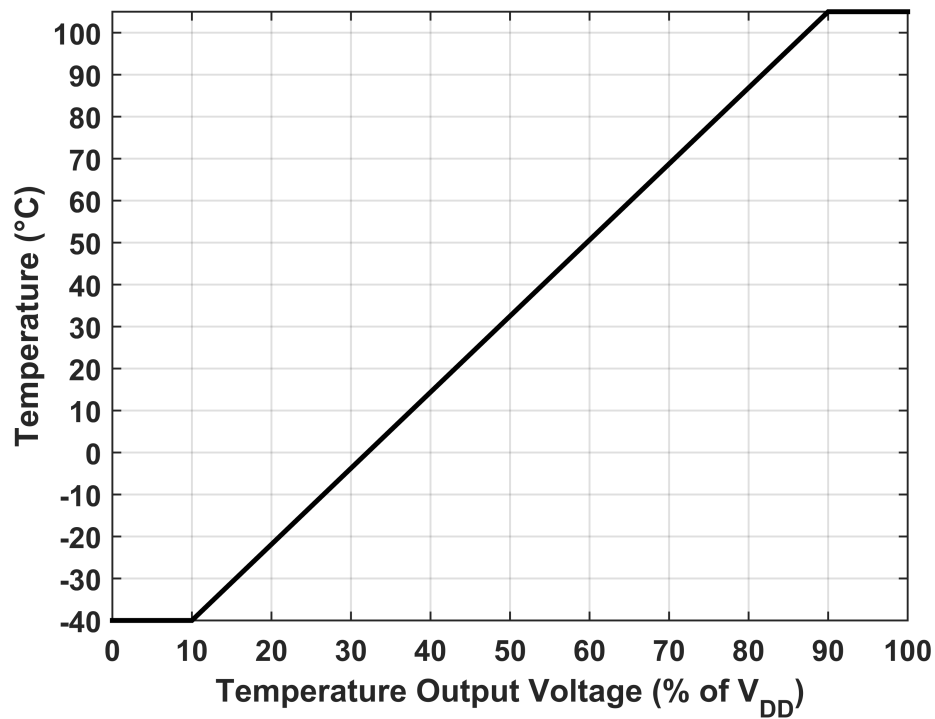

Figure 9. Temperature vs. VT Output Analog Voltage

## 7. Soldering Information

This section discusses soldering considerations for the HS411x.

Standard reflow ovens can be used to solder the HS411x series sensor to the PCB. The peak temperature ( $T_p$ ) for use with the JEDEC J-STD-020D standard soldering profile is 260°C. For manual soldering, the contact time must be limited to 5 seconds at up to 350°C. In either case, if solder paste is used, it is recommended to use 'no-clean' solder paste to avoid the need to wash the PCB.

When a relative humidity sensor is exposed to the high heat associated with the soldering process, the sensor element tends to dry out. To avoid an offset in the relative humidity readings, the sensor element must be rehydrated after the soldering process. Care must also be taken when selecting the temperatures and durations involved in the soldering process to avoid irreversibly damaging the sensor element.

The recommended soldering profile for a lead-free (RoHS-compliant) process is shown below.

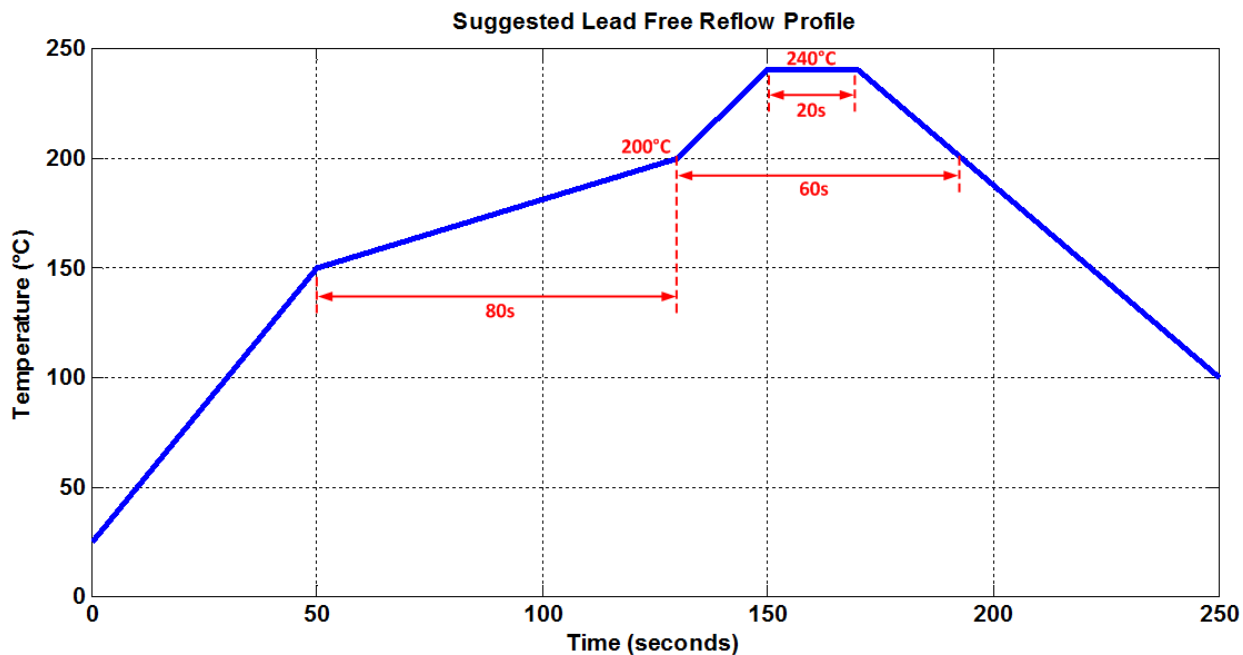

**Figure 10. Recommended Soldering Profile**

It is important to ensure this temperature profile is measured at the sensor itself. Measuring the profile at a larger component with a higher thermal mass means the temperature at the small sensor will be higher than expected.

For manual soldering, the contact time must be limited to **5 seconds** with a maximum iron temperature of **350°C**.

In either case, a board wash after soldering is **not** recommended. Therefore, if a solder paste is used, it is strongly recommended that a “**no-clean**” solder paste is used to avoid the need to wash the PCB.

After soldering, the recommended rehydration process should be done. Otherwise, there may be an initial offset in the relative humidity readings, which will slowly disappear as the sensor get exposed to ambient conditions.

Recommended rehydration process:

- A relative humidity of 75% RH at room temperature for at least 12 hours.
- or
- A relative humidity of 40% to 50% RH at room temperature for 3 to 5 days.

## 8. PCB Layout Guide

When designing the PCB, undesired heat transfer paths to the HS411x series must be minimized. Excessive heat from other components on the PCB will result in inaccurate temperature and relative humidity measurements. As such, **solid metal planes for power supplies should be avoided in the vicinity of the sensor** since these will act as thermal conductors. To further reduce the heat transfer from other components on the board, openings can be milled into the PCB as shown in Figure 11.

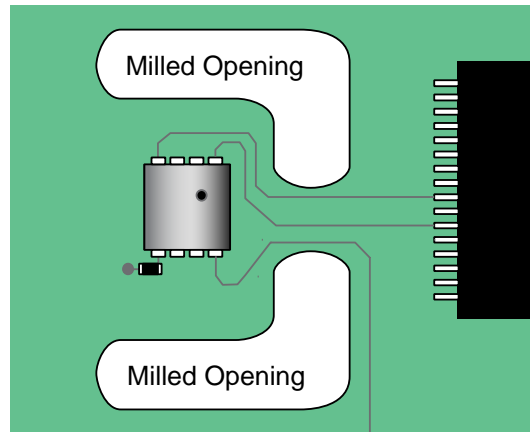

Figure 11. Milled PCB Openings for Thermal Isolation

## 9. Storage and Handling

Recommendation: Once the sensors are removed from their original packaging, store them in metal-in antistatic bags.

Avoid using polyethylene antistatic bags as they may affect sensor accuracy.

The nominal storage conditions are 10 to 50°C and humidity levels within 20% to 60% RH. If stored outside of these conditions for extended periods of time, the sensor readings may exhibit an offset. The sensor can be reconditioned and brought back to its calibration state by applying the following procedure:

1. Bake at a temperature of 100°C with a humidity < 10% RH for 10 to 12 hours.
2. Rehydrate the sensor at a humidity of 75% RH and a temperature between 20°C to 30°C for 12 to 14 hours.

## 10. Quality and Reliability

The HS411x series is available as a qualified product for consumer and industrial market applications. All data specified parameters are guaranteed if not stated otherwise.

## 11. Package Outline Drawings

The package outline drawings are located at the end of this document and are accessible from the Renesas website. The package information is the most current data available and is subject to change without revision of this document.

## 12. Ordering Information

Part Number	Package Description	Carrier Type	Temperature Range
HS4111	Relative Humidity and Temperature Sensor, with Membrane, Analog Output. ±1.5% RH (Typical), 2.5 × 2.5 × 0.9 mm, <a href="#">8-LGA</a>	Reel	-40°C to +105°C
HS4113	Relative Humidity and Temperature Sensor, with Membrane, Analog Output. ±2.5% RH (Typical), 2.5 × 2.5 × 0.9 mm, <a href="#">8-LGA</a>	Reel	-40°C to +105°C

## 13. Revision History

Revision	Date	Description
1.03	Mar 29, 2023	<ul style="list-style-type: none"> <li>▪ Removed HS4112 and HS4114</li> <li>▪ Added maximum supply voltage</li> </ul>
1.02	Apr 28, 2022	<ul style="list-style-type: none"> <li>▪ Added AEC-Q100 qualified, -40°C to +105C</li> <li>▪ Added Industrial JEDEC qualified, -40°C to +105C</li> <li>▪ Completed other minor changes</li> </ul>
1.01	Apr 14, 2022	Added AEC-Q100.
1.00	Feb 4, 2022	Initial release.

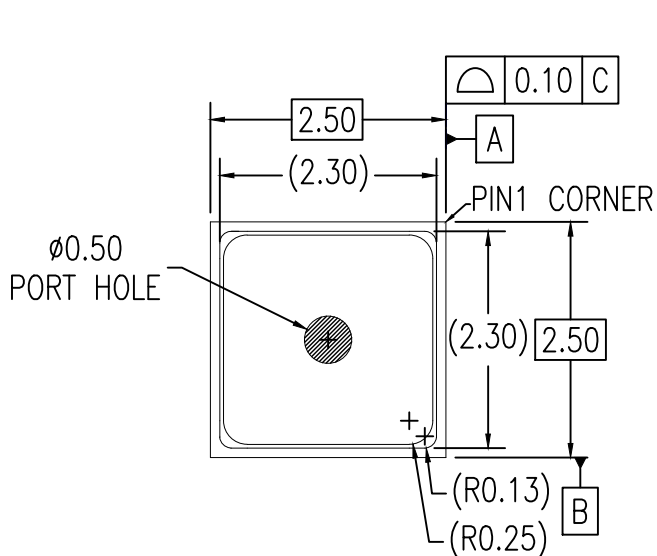

TOP VIEW

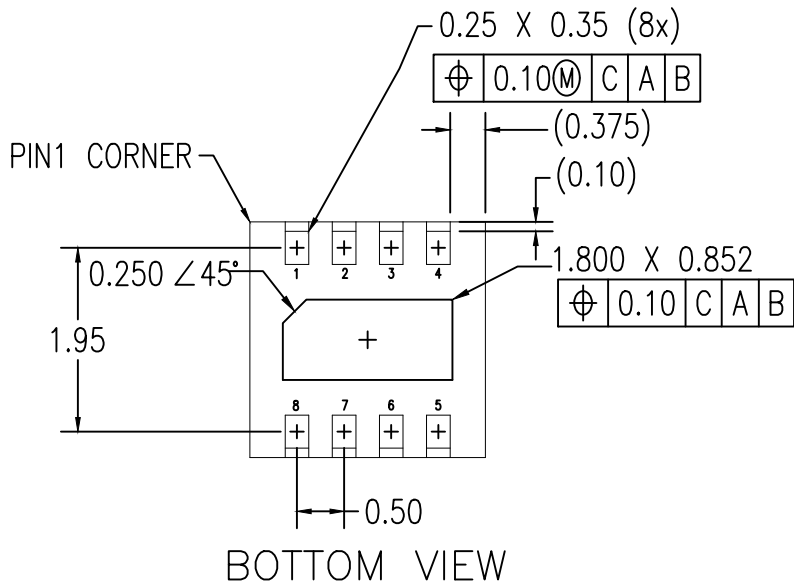

BOTTOM VIEW

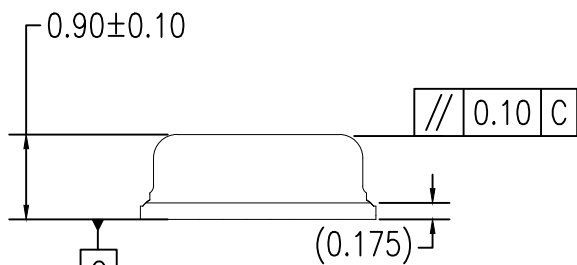

SIDE VIEW

NOTES:

DIMENSIONS AND TOLERANCES IN MM.

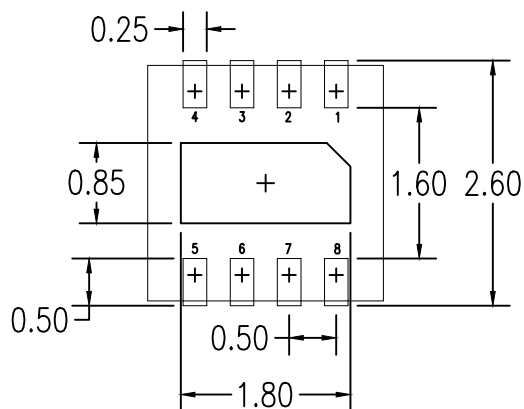

#### RECOMMENDED LAND PATTERN DIMENSION

#### NOTES:

1. ALL DIMENSION ARE IN MM. ANGLES IN DEGREES.
2. LAND PATTERN RECOMMENDATION PER IPC-7351B  
GENERIC REQUIREMENT FOR SURFACE MOUNT DESIGN  
AND LAND PATTERN.

Package Revision History		
Date Created	Rev No.	Description
Sep t 6, 2020	00	Initial Release