

### HS6B Subminiature Interlock Switches

**Key features:**

- Only 78 x 30 x 15mm
- Two actuator entrances provide flexibility for installation options
- Integrated molded cable reduces wiring time
- IP67 (IEC60529)
- Direct Opening Action
- Actuators comply with ISO14119 and EN1088



**Part Numbers**

Contact Configuration	Cable Length	Part Number
1NC-1NO 	1m	HS6B-11B01
	<b>3m</b>	<b>HS6B-11B03</b>
	5m	HS6B-11B05
2NC 	1m	HS6B-02B01
	<b>3m</b>	<b>HS6B-02B03</b>
	5m	HS6B-02B05
2NC-1NO 	1m	HS6B-12B01
	<b>3m</b>	<b>HS6B-12B03</b>
	5m	HS6B-12B05
3NC 	1m	HS6B-03B01
	<b>3m</b>	<b>HS6B-03B03</b>
	5m	HS6B-03B05

Standard stock items in bold.

**Actuator Keys (order separately)**

Appearance	Part Number	Shape
	HS9Z-A61	Straight
	HS9Z-A62	Right-angle
	HS9Z-A65	Adjustable actuator 90° angle
	HS9Z-A66	Adjustable actuator 180° angle

Actuators are not included and must be ordered separately.

**Contact Configuration & Operation Chart**

Type	Contact Configuration	Contact Operation Chart
HS6B-11	1NC-1NO 	0.8 (Actuator Mounting Reference Position) 0   5.5   5.8   28.2 (Travel: mm) 
HS6B-02	2NC 	
HS6B-12	2NC-1NO 	
HS6B-03	3NC 	

## Specifications

Conforming to Standards		EN1088, IEC60947-5-1, EN60947-5-1, GS-ET-15, IEC60664-1, IEC60204-1, EN60204-1, UL508, CSA C22.2 No. 14
Operating Temperature		-25 to +70°C (no freezing)
Storage Temperature		-40 to +80°C (no freezing)
Relative Humidity		45 to 85% RH (no condensation)
Storage Humidity		95% maximum (no condensation)
Altitude		2,000m maximum
Pollution Degree		3
Rated Insulation Voltage ( $U_i$ )		300V
Impulse Withstand Voltage ( $U_{imp}$ )		4kv
Insulation Resistance		Between live & dead metal parts: 100MΩ maximum Between positive & negative live parts: 100MΩ minimum
Electric Shock Protection Class		Class II
Degree of Protection		IP67 (IEC60529)
Vibration Resistance	Operating Extremes	5 to 55 Hz, half amplitude 0.5 mm
	Damage Limits	30Hz, half amplitude 1.5mm
Contact Resistance		300mΩ maximum
Shock Resistance	Operating Extremes	300m/s <sup>2</sup> (30G)
	Damage Limits	1000m/s <sup>2</sup> (100G)
Direct Opening Travel		8mm minimum
Direct Opening Force		60N minimum
Thermal Current ( $I_{th}$ )		2.5A
Operating Frequency		1200 operations/hour
Mechanical Life		1,000,000 operations (GS-ET-15)
Recommended Actuation Speed		0.05 to 1.0m/s
Wire Tensile Strength		50N minimum
Electrical Life		100,000 operations (at full rated load)
Conditional Short-Circuit Current		50A 250V (IEC60947-5-1, IEC60269-1, -2)
Weight		120g

## Contact Ratings

		Operating Voltage ( $U_e$ )	30V	125V	250V
Rated Operating Current ( $I_e$ )	AC	Resistive load (AC-12)	–	2.5A	1.5A
		Inductive load (AC-15)	–	1.5A	0.75A
	DC	Resistive load (DC-12)	2.5A	1.1A	0.55A
			(2A)	(0.4)A	(0.2A)
		Inductive load (DC-13)	2.3A	0.55A	0.27A
			(1A)	(0.22A)	(0.1A)

## Installation Notes

### Recommended Screw Torque

- Safety switch body installation (M4 screw): 1.0~1.5N·m
- Actuator installation (M4 screw): 1.0~1.5N·m

### Handling Cables

- Do not tighten or loosen the fastened cable conduit of the safety switch
- Minimum bend radius of installed cable: 40mm



## Wiring Designations

Part Number	Contact	Terminal #	Color
HS6B-12B01 (2NC-1NO)	NC	11-12	blue-blue/white
	NC	21-22	brown-brown/white
	NO	33-34	orange-orange/white
HS6B-03B01 (3NC)	NC	11-12	blue-blue/white
	NC	21-22	brown-brown/white
	NC	31-32	orange-orange/white
HS6B-11B01 (1NC-1NO)	NC	11-12	blue-blue/white
	NO	33-34	orange-orange/white
HS6B-02B01 (2NC)	NC	11-12	blue-blue/white
	NC	31-32	orange-orange/white

## Dimensions (mm) HS6B



## Installation



The interlock switch can be mounted in two directions.

## Using straight actuator (HS9Z-A61)

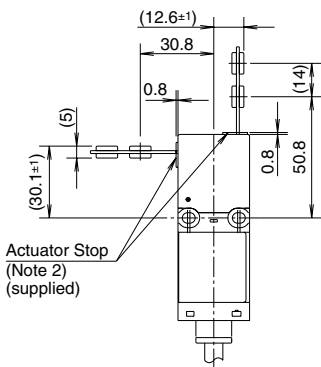

## Using Right-angle actuator (HS9Z-A62)

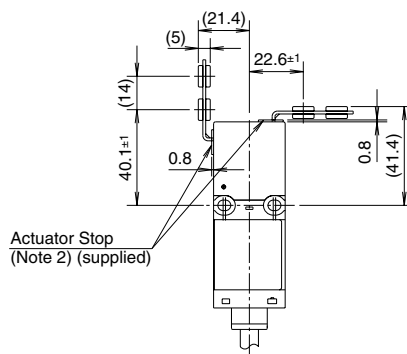

## Using Angle Adjustable Actuator (HS9Z-A65/A66)

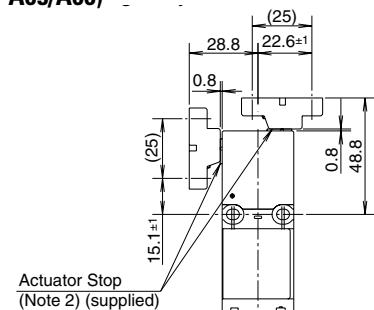

**Straight actuator (HS9Z-A61)**

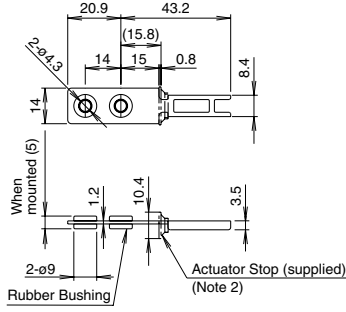

**Right-angle actuator (HS9Z-A62)**



**Actuator Installation**

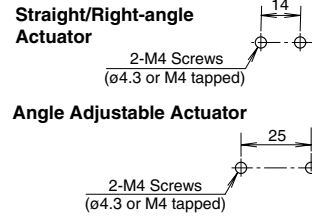

**Adjustable Actuator (HS9Z-A65)**

**Horizontal Adjustment**

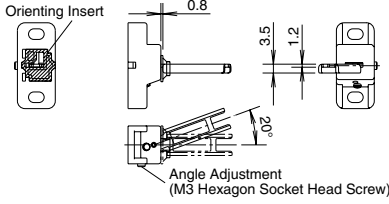

**Vertical Adjustment**

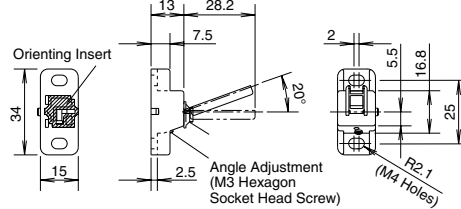

The orientation of actuator adjustment (horizontal/vertical) can be changed using the orienting insert (white plastic) installed on the back of the actuator.

The base is made of glass-reinforced PA66 (66 nylon). Angle adjustment screws are stainless steel. When using adhesive on screws, take material compatibility into consideration.

Note 2: After mounting the actuator, remove the actuator stop from the interlock switch.

**Adjustable Actuator (HS9Z-A66)**

The HS9Z-A65 and HS9Z-A66 have the metal key inserted in opposite directions.

**Horizontal Adjustment**

Angle Adjustment (M3 Hexagon Socket Head Screw)

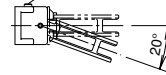

**Vertical Adjustment**

Angle Adjustment (M3 Hexagon Socket Head Screw)

