



HumPRC™ Series
900MHz Remote Control
Transceiver Module
Data Guide

Wireless made simple®

Warning: Some customers may want Linx radio frequency (“RF”) products to control machinery or devices remotely, including machinery or devices that can cause death, bodily injuries, and/or property damage if improperly or inadvertently triggered, particularly in industrial settings or other applications implicating life-safety concerns (“Life and Property Safety Situations”).

NO OEM LINX REMOTE CONTROL OR FUNCTION MODULE SHOULD EVER BE USED IN LIFE AND PROPERTY SAFETY SITUATIONS. No OEM Linx Remote Control or Function Module should be modified for Life and Property Safety Situations. Such modification cannot provide sufficient safety and will void the product’s regulatory certification and warranty.

Customers may use our (non-Function) Modules, Antenna and Connectors as part of other systems in Life Safety Situations, but only with necessary and industry appropriate redundancies and in compliance with applicable safety standards, including without limitation, ANSI and NFPA standards. It is solely the responsibility of any Linx customer who uses one or more of these products to incorporate appropriate redundancies and safety standards for the Life and Property Safety Situation application.

Do not use this or any Linx product to trigger an action directly from the data line or RSSI lines without a protocol or encoder/decoder to validate the data. Without validation, any signal from another unrelated transmitter in the environment received by the module could inadvertently trigger the action.

All RF products are susceptible to RF interference that can prevent communication. RF products without frequency agility or hopping implemented are more subject to interference. This module does have a frequency hopping protocol built in, but the developer should still be aware of the risk of interference.

Do not use any Linx product over the limits in this data guide. Excessive voltage or extended operation at the maximum voltage could cause product failure. Exceeding the reflow temperature profile could cause product failure which is not immediately evident.

Do not make any physical or electrical modifications to any Linx product. This will void the warranty and regulatory and UL certifications and may cause product failure which is not immediately evident.

Table of Contents

1	Description
1	Features
2	Ordering Information
2	Absolute Maximum Ratings
3	Electrical Specifications
5	Typical Performance Graphs
10	Pin Assignments
11	Pin Descriptions
13	Module Dimensions
14	Theory of Operation
15	Module Description
16	Transceiver Operation
17	Transmit Operation
17	Receive Operation
18	System Operation
19	Reading the Transmitter Address
20	Frequency Hopping Spread Spectrum
21	Addressing Modes
22	AES Encryption
23	The Join Process
26	Operation with the HumPRO™ Series
27	Carrier Sense Multiple Access (CSMA)
28	Acknowledgement
28	External Amplifier Control
29	Configuring the Status Lines
29	Using the LATCH_EN Line
30	Using the MODE_IND Line
31	Using the PB Line
32	Restore Factory Defaults

HumPRC™ Series 900MHz Remote Control RF Transceiver Module



Data Guide

Description

The HumPRC™ Series is the most complete system to integrate bi-directional remote control into many different applications. No programming is required, and both module and finished hardware options are available, making it the easiest solution to implement.



Figure 1: Packages

The module provides long-range transmission at 900MHz utilizing frequency hopping and industry-standard encryption for secure and robust communications. The HumPRC™ Series interoperates with Linx's HumPRO™ family, making it the only remote control solution that simultaneously supports data applications for seamless integration with sensor and control IoT applications.

Eight status lines can be set up in any combination of inputs and outputs for the transfer of button or contact states. A selectable acknowledgement indicates that the transmission was successfully received.

Primary settings are hardware-selectable, which eliminates the need for an external microcontroller or other digital interface. For advanced features, optional software configuration is provided by a UART interface.

Housed in a compact reflow-compatible SMD package, the transceiver requires no external RF components except an antenna, which greatly simplifies integration and lowers development and assembly costs.

Features

- Add Bi-directional remote control capabilities to any product
- Pre-compiled software
- No programming required
- 128-bit AES encryption
- 8 status lines
- FHSS Algorithm
- Selectable acknowledgements
- FCC and IC Pre-certified versions
- Fully interoperable with all HumPRO™ Series devices & gateways

- 32 Using the Low Power Features
- 34 The Command Data Interface
- 35 Reading from Registers
- 36 Writing to Registers
- 37 Command Length Optimization
- 38 Example Code for Encoding Read/Write Commands
- 40 The Command Data Interface Command Set
- 78 Typical Applications
- 82 HumPRC™ Series Long-Range Handheld Transmitter
- 84 Usage Guidelines for FCC Compliance
- 84 Additional Testing Requirements
- 85 Information to the User
- 86 Product Labeling
- 86 FCC RF Exposure Statement
- 86 Antenna Selection
- 88 Castellation Version Reference Design
- 90 Power Supply Requirements
- 90 Antenna Considerations
- 91 Interference Considerations
- 92 Pad Layout
- 93 Microstrip Details
- 94 Board Layout Guidelines
- 95 Helpful Application Notes from Linx
- 96 Production Guidelines
- 96 Hand Assembly
- 96 Automated Assembly
- 98 General Antenna Rules
- 100 Common Antenna Styles
- 102 Regulatory Considerations

Ordering Information

Ordering Information	
Part Number	Description
HUM-900-PRC	900MHz HumPRC™ Series Remote Control Transceiver, Castellation Interface, External Antenna Connection
HUM-900-PRC-CAS	900MHz HumPRC™ Series Remote Control Transceiver, Castellation Interface, External Antenna Connection, FCC & IC Certified
HUM-900-PRC-UFL	900MHz HumPRC™ Series Remote Control Transceiver, Castellation Interface, U.FL / MHF Compatible Connector, FCC & IC Certified
EVM-900-PRC-CAS	900MHz HumPRC™ Series Carrier Board, Through-Hole Pin Interface, RP-SMA Connector, FCC & IC Certified
EVM-900-PRC-UFL	900MHz HumPRC™ Series Carrier Board, Through-Hole Pin Interface, U.FL / MHF Compatible Connector, FCC & IC Certified
MDEV-900-PRC	900MHz HumPRC™ Series Master Development System

Figure 2: Ordering Information

Absolute Maximum Ratings

Absolute Maximum Ratings				
Supply Voltage V_{CC}	-0.3	to	+3.9	VDC
Any Input or Output Pin	-0.3	to	$V_{CC} + 0.3$	VDC
RF Input			0	dBm
Operating Temperature	-40	to	+85	°C
Storage Temperature	-40	to	+85	°C

Exceeding any of the limits of this section may lead to permanent damage to the device. Furthermore, extended operation at these maximum ratings may reduce the life of this device.

Figure 3: Absolute Maximum Ratings



Warning: This product incorporates numerous static-sensitive components. Always wear an ESD wrist strap and observe proper ESD handling procedures when working with this device. Failure to observe this precaution may result in module damage or failure.

Electrical Specifications

HumPRC™ Series Transceiver Specifications						
Parameter	Symbol	Min.	Typ.	Max.	Units	Notes
Power Supply						
Operating Voltage	V_{CC}	2.0		3.6	VDC	
TX Supply Current	I_{CCTX}					
900MHz at +10dBm			40.5	41.5	mA	1,2
900MHz at 0dBm			22	24	mA	1,2
RX Supply Current	I_{CCRX}		23.5	24.5	mA	1,2,3
Power-Down Current	I_{PDN}		0.7	1.4	μA	1,2
RF Section						
Operating Frequency Band	F_C	902		928	MHz	
Number of hop channels						
@ 19.2kbps RF Rate			50/64			
@ 152.34kbps RF Rate			26/32			
Channel spacing						
@ 19.2kbps RF Rate			375.9		kHz	
@ 152.34kbps RF Rate			751.81		kHz	
20 dB OBW						
@ 19.2kbps RF Rate			64		kHz	
@ 152.34kbps RF Rate			315		kHz	
Receiver BW						
@ 19.2kbps RF Rate			102		kHz	
@ 152.34kbps RF Rate			232		kHz	
FSK deviation						
@ 19.2kbps RF Rate			± 19.2		kHz	
@ 152.34kbps RF Rate			± 51		kHz	
Scan time / channel (avg)						
@ 19.2kbps RF Rate			1.2		ms	
@ 152.34kbps RF Rate			0.335		ms	
FHSS Lock time						
@ 19.2kbps RF Rate			63		ms	
@ 152.34kbps RF Rate			26		ms	
Modulation			2FSK			
Data Encoding			6/7 RLL			
Number of Hop Sequences			6			

HumPRC™ Series Transceiver Specifications						
Parameter	Symbol	Min.	Typ.	Max.	Units	Notes
Receiver Section						
Spurious Emissions				-47	dBm	
IF Frequency			304.7		kHz	
Receiver Sensitivity						5
@min rate		-98	-101		dBm	5
@max rate		-91	-94		dBm	5
RSSI Dynamic Range			85		dB	
CSMA RSSI Threshold			-70		dBm	
Transmitter Section						
Max Output Power	P_O	+8.5	+9.5		dBm	6
Harmonic Emissions	P_H		-41		dBc	6
Output Power Range		-5		9	dB	6
Antenna Port						
RF Impedance	R_{IN}		50		Ω	4
Environmental						
Operating Temp. Range		-40		+85	$^{\circ}C$	4
Timing						
Module Turn-On Time						
Via V_{CC}		63		173	ms	4
Via $\overline{POWER_DOWN}$			35		ms	4
Via Standby			4		ms	4
Serial Command Response						
Volatile R/W			0.4	5	ms	8
NV Update			2.4	50	ms	8
Factory Reset		204		329	ms	13
Channel Dwell Time				400	ms	
Interface Section						
UART Data rate		9,600		115,200	bps	
Input						
Logic Low	V_{IL}			$0.3 \cdot V_{CC}$	VDC	
Logic High	V_{IH}	$0.7 \cdot V_{CC}$			VDC	

HumPRC™ Series Transceiver Specifications						
Parameter	Symbol	Min.	Typ.	Max.	Units	Notes
Output						
Logic Low, MODE_IND, ACK_OUT	V_{OLM}			$0.3 \cdot V_{CC}$	VDC	1,9
Logic High, MODE_IND, ACK_OUT	V_{OHM}	$0.7 \cdot V_{CC}$			VDC	1,9
Logic Low	V_{OL}			$0.3 \cdot V_{CC}$		1,10
Logic High	V_{OH}	$0.7 \cdot V_{CC}$				1,10
Flash (Non-Volatile) Memory Specifications						
Flash Refresh Cycles		2,000			cycles	11
1. Measured at $3.3V V_{CC}$						9. 60mA source/sink
2. Measured at $25^{\circ}C$						10. 6mA source/sink
3. Input power < -60dBm						11. Number of non-volatile memory refresh cycles. The number of write operations per refresh cycle varies from 8 to 150.
4. Characterized but not tested						12. With CSMA disabled
5. PER = 1%						13. Start of factory reset command to end of last ACK response
6. Into a 50-ohm load						
7. No RF interference						
8. From end of command to start of response						

Figure 4: Electrical Specifications

Typical Performance Graphs

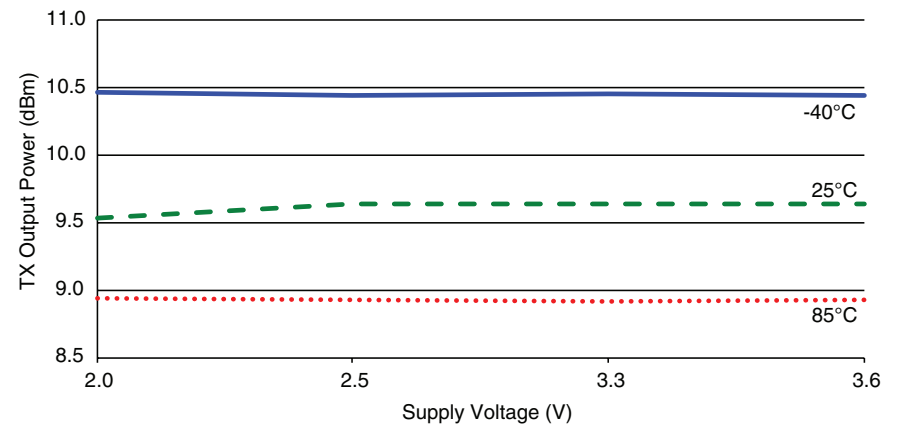

Figure 5: HumPRC™ Series Transceiver Max Output Power vs. Supply Voltage

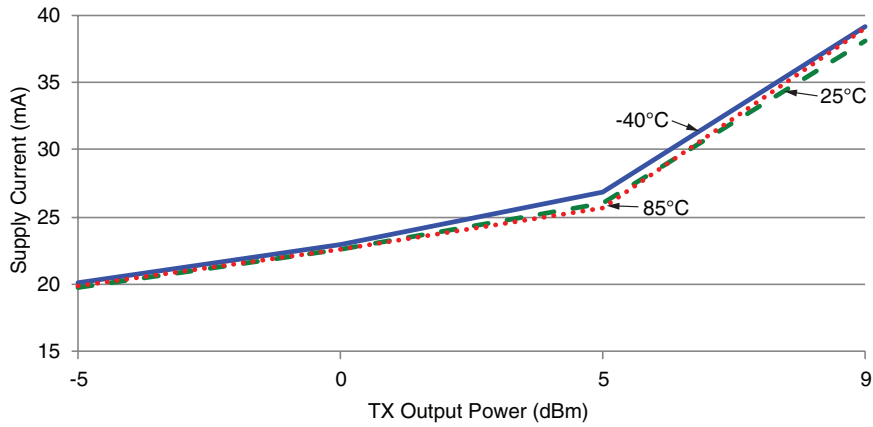

Figure 6: HumPRC™ Series Transceiver Average Current vs. Transmitter Output Power at 2.5V

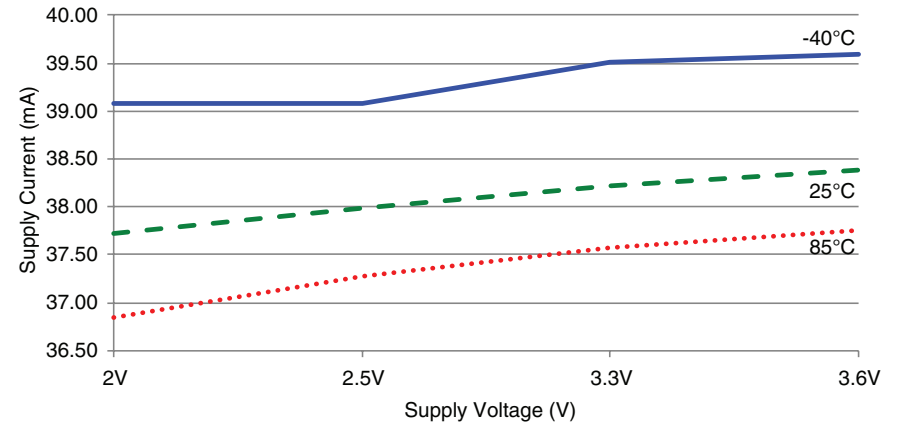

Figure 9: HumPRC™ Series Transceiver TX Current vs. Supply Voltage at Max Power

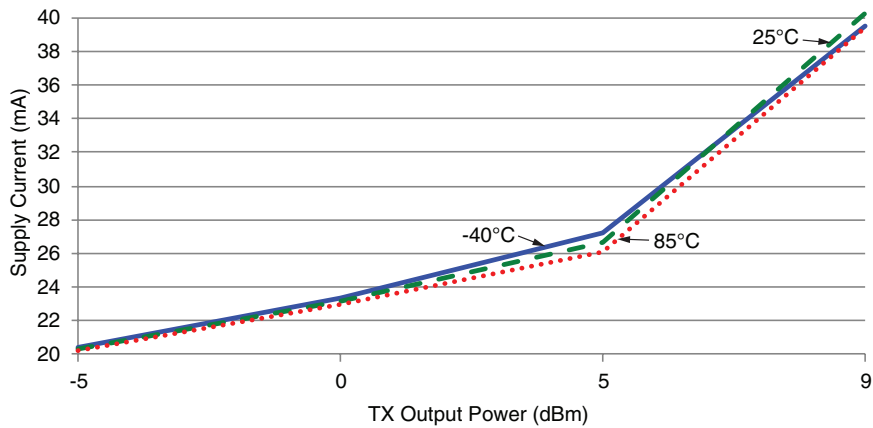

Figure 7: HumPRC™ Series Transceiver Average TX Current vs. Transmitter Output Power at 3.3V

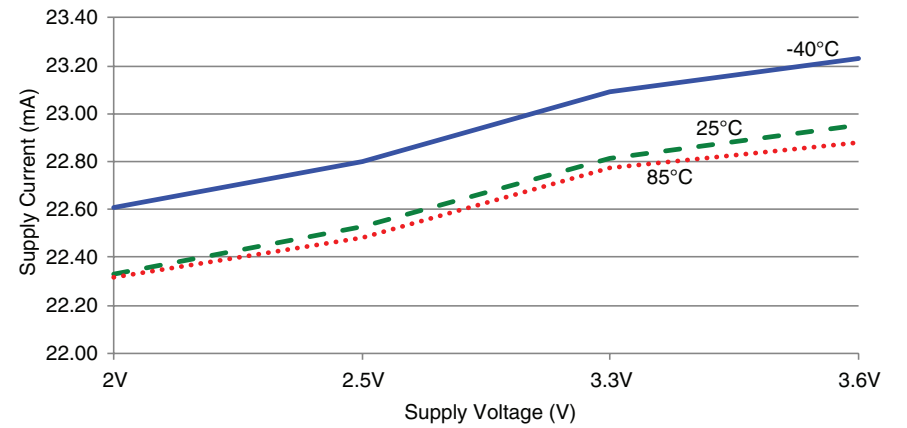

Figure 8: HumPRC™ Series Transceiver TX Current vs. Supply Voltage at OdBm



Figure 10: HumPRC™ Series Transceiver RX Scan Current vs. Supply Voltage, 9.6kbps

Current consumption while the module is scanning for a transmission. The current is approximately 0.5mA higher when receiving data at 9.6kbps.

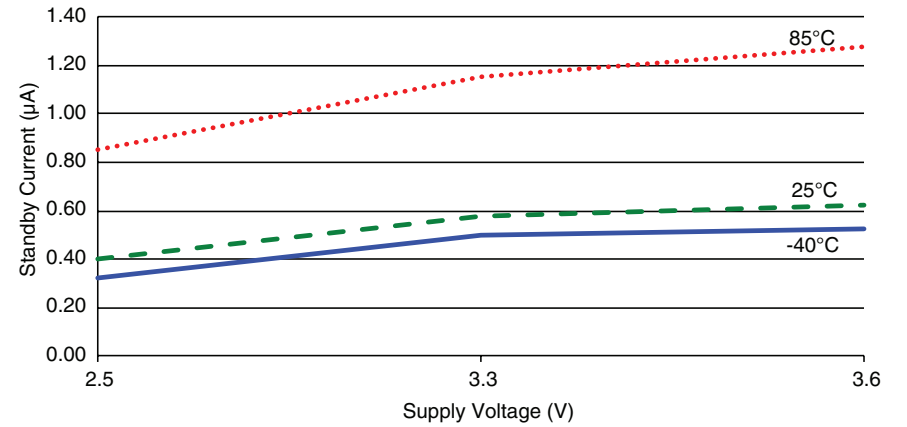

Figure 12: HumPRC™ Series Transceiver Standby Current Consumption vs. Supply Voltage

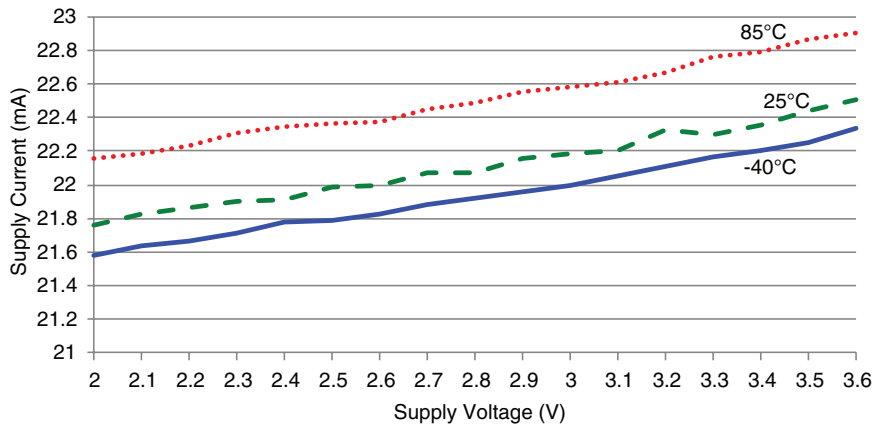

Figure 11: HumPRC™ Series Transceiver RX Scan Current vs. Supply Voltage, 115.2kbps

Current consumption while the module is scanning for a transmission. The current is approximately 2mA higher when receiving data at 115.2kbps.

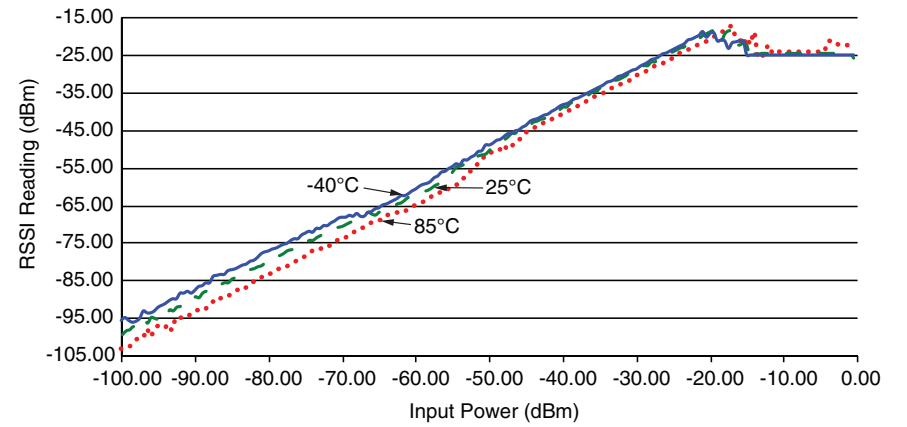

Figure 13: HumPRC™ Series Transceiver RSSI Voltage vs. Input Power

Pin Descriptions			
Pin Number	Name	I/O	Description
13	LATCH_EN	I	If this line is high, then the status line outputs are latched (a received command to activate a status line toggles the output state). If this line is low, then the output lines are momentary (active for as long as a valid signal is received). Do not leave floating.
19	ANTENNA	—	50-ohm RF Antenna Port
21	VCC	—	Supply Voltage
22	$\overline{\text{RESET}}^2$	I	This line resets the module when pulled low. It should be pulled high for normal operation. Leave unconnected to minimize leakage current.
23	LNA_EN	O	Low Noise Amplifier Enable. This line is driven high when receiving. It is intended to activate an optional external LNA.
24	PA_EN	O	Power Amplifier Enable. This line is driven high when transmitting. It is intended to activate an optional external power amplifier.
26	CMD_DATA_OUT	O	Command Data Out. Output line for the serial interface commands
27	CMD_DATA_IN	I	Command Data In. Input line for the serial interface commands. If serial control is not used, this line should be tied to supply to minimize current consumption.
28	ACK_EN	I	Pull this line high to enable the module to send an acknowledgement message after a valid control message has been received. Do not leave floating.
29	PB ¹	I	A high on this line initiates the Join process, which causes two units to accept each other's transmissions. It is also used with a special sequence to reset the module to factory default configuration.
30	MODE_IND	O	This line indicates module activity. It can source enough current to drive a small LED, causing it to flash. The duration of the flashes indicates the module's current state.
31	ACK_OUT	O	This line goes high when the module receives an acknowledgement message from another module after sending a control message.

1. These lines have an internal 20kΩ pull-down resistor
2. These lines have an internal 10kΩ pull-up resistor

Figure 17: HumPRC™ Series Transceiver Pin Descriptions

Module Dimensions

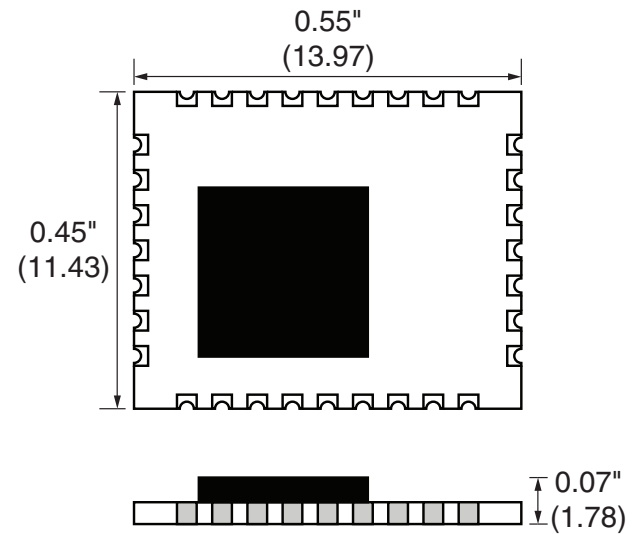

Figure 18: HumPRC™ Series Transceiver Dimensions

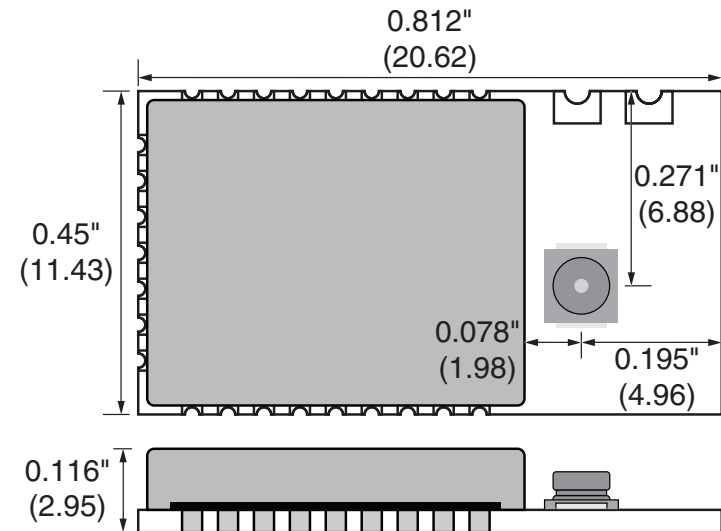

Figure 19: HumPRC™ Series Transceiver Pre-certified Version Dimensions

Theory of Operation

The HumPRC™ Series transceiver is a low-cost, high-performance synthesized FSK transceiver. Figure 20 shows the module's block diagram.

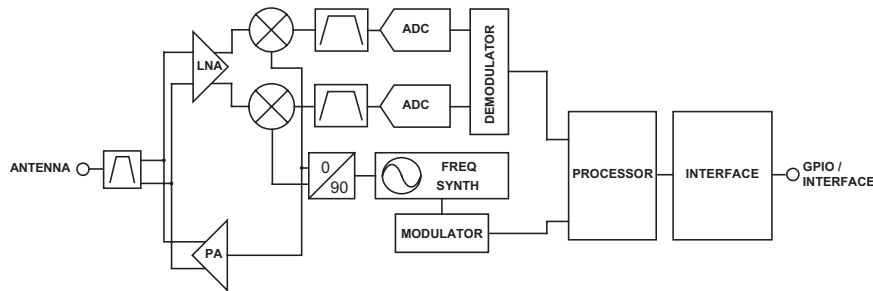

Figure 20: HumPRC™ Series Transceiver RF Section Block Diagram

The HumPRC™ Series transceiver operates in the 902 to 928MHz frequency band. The transmitter output power is programmable. The range varies depending on the antenna implementation and the local RF environment.

The RF carrier is generated directly by a frequency synthesizer that includes an on-chip VCO. The received RF signal is amplified by a low noise amplifier (LNA) and down-converted to I/Q quadrature signals. The I/Q signals are digitized by ADCs.

A low-power onboard communications processor performs the radio control and management functions including Automatic Gain Control (AGC), filtering, demodulation and packet synchronization. A control processor performs the higher level functions and controls the serial and hardware interfaces.

A crystal oscillator generates the reference frequency for the synthesizer and clocks for the ADCs and the processor.

Module Description

The HumPRC™ Series remote control transceiver module is a completely integrated RF transceiver and processor that is designed to send the logic state of its inputs to a remote unit and replicate the logic states of the remote unit's inputs. This allows for the easy creation of basic remote control systems.

The module operates through a series of dedicated I/O lines, resulting in a solution that does not need any software development. The module does have a serial interface that allows for some configuration in applications that need specific control. This interface is likely not needed for basic remote control applications.

Since this module can act as both transmitter and receiver, terminology and descriptions are important. This guide uses the term Initiating Unit (IU) to describe a module that is transmitting commands. Responding Unit (RU) is used to describe a module that is receiving commands.

The module has 8 status lines numbered S0 through S7. These can be set as inputs for buttons or contacts or as outputs to drive application circuitry. When S0 is taken high on the IU, S0 goes high on the RU, and so forth. A line that is an input on one side needs to be set as an output on the other side.

The HumPRC™ Series adds a remote control application layer to the HumPRO™ Series data modem protocol stack. This enables the simple creation of remote control systems that benefit from the robust feature set of the protocol stack, such as a fast locking Frequency Hopping Spread Spectrum (FHSS) algorithm, AES128 encryption, 32-bit addressing, assured delivery and a simple Join Process for associating multiple modules with each other.

As a result, much of the HumPRC™ Series terminology is the same as the HumPRO™ Series. Likewise, most of the software registers are the same though some do not apply to the remote control application.

A result of this common protocol stack is that HumPRC™ Series transmissions can be received by another HumPRC™ Series module for simple remote control applications or by a HumPRO™ Series module for applications that want to combine data transmissions (such as sensor values) with remote control functionality.

Transceiver Operation

The transceiver has two roles: Initiating Unit (IU) that transmits control messages and Responding Unit (RU) that receives control messages. If all of the status lines are set as inputs, then the module is set as an IU only. In this role, the module stays in a low power sleep mode until a status line goes high, starting the Transmit Operation.

If all of the status lines are set as outputs, then the module is set as an RU only. It stays in Receive Operation looking for a valid transmission from a paired IU.

A module with both input and output status lines can operate as an IU and an RU. The module idles in Receive Operation until either a valid transmission is received or a status line input goes high, initiating the Transmit operation.

When an input goes high, the transceiver captures the logic state of each of the status lines. The line states are placed into a packet and transmitted using the configured addressing mode, hop sequence and encryption key (if enabled).

An associated RU receives the packet and sets its status line outputs according to the received packet. It then stays synchronized with the IU and updates the states of its outputs with every packet. Its outputs can be connected to external circuitry that activates when the lines go high.

The RU can also send an acknowledgement back to the IU. If the ACK_EN line is high when a valid control packet is received, the RU sends back an acknowledgement. When the IU receives the acknowledgement, it raises its ACK_OUT line. The ACK_EN line can be connected to ground to disable acknowledgements, connected to the power supply to acknowledge on receipt of the valid command or controlled by external circuitry to acknowledge when an action has taken place.

The ACK_EN can be connected to an LED as an indication to the user or used by the system in other ways, such as updating a display or being used to deactivate an automated system.

Note: Although the functionality of the HumPRC™ is very similar to the HumRC™, the underlying protocol and operation are very different. The two families are not compatible.

Transmit Operation

When a status line input goes high, the module enters the Initiating Unit role. In this role, the module captures the logic states of the status line inputs and automatically creates a REMOTE_ACTIVATE packet. The packet is transmitted every 140ms nominally (240ms max) for as long as a status line input is held high. After each transmission, the module listens for a REMOTE_CONFIRM reply from the RU. This continues for as long as any status line input is high.

The REMOTE_CONFIRM packet contains two values. One indicates how long the ACK_OUT line should go high on the IU (20ms by default) and the other indicates if the IU should stay awake after the status line inputs go low (go to sleep by default). The module activates the ACK_OUT line for as long as instructed and loops back to check the status line inputs and send another REMOTE_ACTIVATE packet.

When all status line inputs go low, the module transmits two REMOTE_ACTIVATE packets indicating that all lines are low. If all status lines are inputs, it then goes to sleep after 760ms unless a REMOTE_CONFIRM packet is received instructing the IU to stay awake longer.

Receive Operation

When the module is awake and not in transmit operation, it is in receive operation listening for valid packets. When a REMOTE_ACTIVATE packet is received, the module enters the Responding Unit role and processes the received status line states. It remains in the RU mode until 760ms elapses without an incoming REMOTE_ACTIVATE message.

Unlatched status line outputs are set to match the corresponding bit state in the received packet.

For latched outputs, the line changes state (off → on or on → off) whenever the corresponding bit changes from 0 to 1. All other combinations of the new and old status bit do not change the status line. This normally changes the output state every time that the associated transmitter input changes from 0 to 1.

If the ACK_EN line is high when a valid message is received, a REMOTE_CONFIRM message is transmitted to the IU with values to set the ACK_OUT high for 20ms and go to sleep after the default 760ms. These values cannot be changed in the HumPRC™ Series, but a packet with different values can be generated using the HumPRO™ Series and a microcontroller.

System Operation

Transmitters and receivers are paired using the built-in Join Process (see the [Join Process](#) for details). One device is configured as an Administrator and creates the network address and encryption key. When Nodes join, the Administrator sends them the encryption key, network address and their unique address within the network. The addressing method used by the HumPRC™ Series modules can support up to hundreds of nodes, depending on the use model (duration of activations and how often they are sent).

It is up to the designer to determine which device makes the most sense as the Administrator in the final system, but there are some common configurations. In a system with one transmitter and one receiver, it does not matter which is the Administrator. In a system where one transmitter is going to activate several receivers, the transmitter is normally the Administrator (Figure 21 a). In a system with one receiver and multiple transmitters, the receiver is normally the Administrator (Figure 21 b).

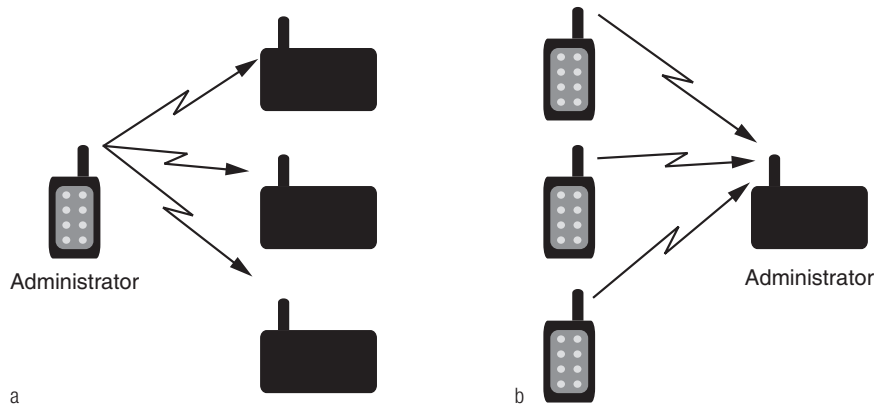

Figure 21: HumPRC™ Series Transceiver Transmitter to Receiver Ratios

A system with multiple transmitters and receivers can use any of the devices as an Administrator (Figure 22 a) or may use a separate device that is only used to join new devices to the network (Figure 22 b). Once all system nodes have received the key and their address, the Administrator node operates the same as any other node.

By default, the Administrator and all Nodes broadcast to the entire network. All transmitters can activate all receivers in the network. An external microcontroller can be used to change the [UDESTIDO](#) register to activate a specific Node in the network. This is a more advanced operation and requires the microcontroller and custom firmware.

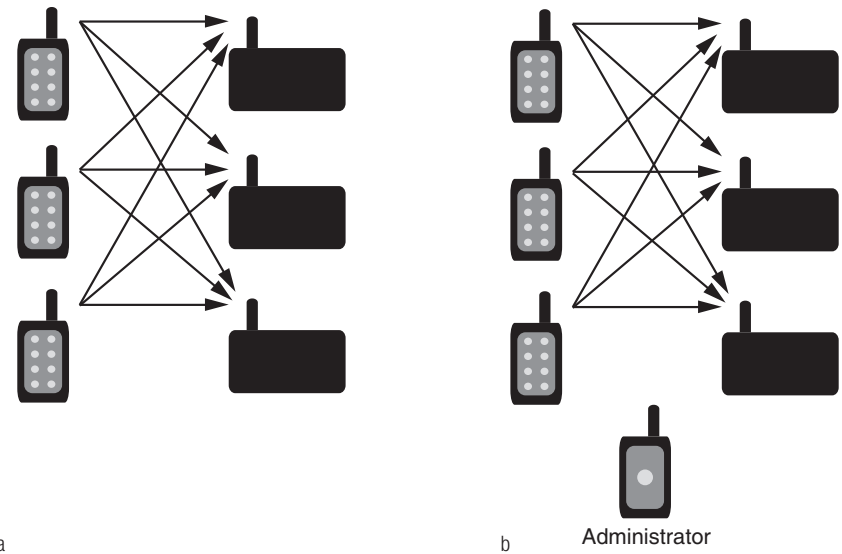

Figure 22: HumPRC™ Series Transceiver Multiple TX and RX

Reading the Transmitter Address

The HumPRC™ Series modules do not require any software for basic operation. There is no compiler to get, no code to write and download into the module. However, the built-in Command Data Interface (CDI) can be used to add additional or advanced functionality to a system.

One such feature is the ability to read out of the receiver the identity of the transmitter that sent the commands. This allows an external processor to log access attempts or set additional controls over which transmitters are allowed to activate the product outside of the module.

By default, the module automatically configures itself to respond to the transmitting module ([AUTOADDR](#) = 0x07). This configuration takes the source address from the received packet and writes it to the UDESTID registers [UDESTID\[0-3\]](#). Reading these registers after a valid transmission has been received indicates the transmitter that sent the command.

Frequency Hopping Spread Spectrum

The module uses Frequency Hopping Spread Spectrum to allow operation at higher power levels per regulations and to reduce interference with other transmitters. The module is configured for operation in one of 6 different hopping sequences. Each sequence uses 26 channels for the high RF data rate or 50 channels for the low RF data rate. Modules must use the same RF data rate and hopping sequence to communicate. Assigning different hopping sequences to multiple networks in the same area minimizes the interference.

When the module is awake and not transmitting, it rapidly scans all channels for a packet preamble. When a module starts transmitting at the beginning of a new channel, it transmits a packet with a long preamble of alternating 0 and 1 bits. This long preamble is sufficient to allow receiving modules to scan through all of the channels in the hopping sequence and find it. Modules that are scanning detect the preamble and pause on that channel, waiting for a valid packet.

If a packet is received with a valid CRC (unencrypted) or authentication (encrypted), the header is examined to determine whether the module should synchronize to the transmitter. Synchronization requires that the hop sequence matches and that the message is addressed to the receiver.

When synchronized, the receiver stays on the current channel to either transmit a packet or to receive an additional packet. Additional packets transmitted on the same channel within the time slot use short preambles since the receivers are already listening to the current channel.

At the end of the time slot for the current channel, all modules which locked to the original transmission switch to the next channel in the hop sequence. The first transmission on each new channel has a long preamble.

A receiver that has synchronized to a transmitter continues to stay in synchronism by staying on the received channel until the expiration of the time slot, then waiting on the next hop channel for the duration of the time slot. If no further packets are received, the receiver loses lock and reverts to scanning. This allows the receiver to stay synchronized for a short while if a packet is not received correctly.

Addressing Modes

The module has very flexible addressing methods selected with the **ADDMODE** register. It can be changed during operation. The transmitting module addresses packets according to the addressing mode configuration. The receiving module processes all addressing types regardless of the **ADDMODE** configuration. If the received message matches the addressing criteria, it is output on the UART. Otherwise it is discarded. The **ADDMODE** configuration also enables assured delivery.

There are three addressing modes: DSN, User and Extended User. Each mode offers different communications methods, but all use source and destination addressing. The source address is for the transmitting unit, the destination address is the intended receiver. Each mode uses different registers for the source and destination addresses.

Extended User Addressing mode uses the customer ID bytes (**CUSTID**[1-0]) for unencrypted messages and the four user destination address bytes (**UDESTID**[3-0]) as a destination address. The module's local address is contained in the four user source ID registers (**USRCID**[3-0]).

In normal operation, each module has a user ID mask (**UMASK**[3-0]) that splits the 32 address bits into up to three fields to provide a network address and address fields for sub-networks, supporting both individual addressing and broadcast addressing within the user's network.

The HumPRC™ Series is normally configured using the Join Process, which sets the addressing mode to Extended User mode. The other modes would normally only be used if the HumPRC™ Series is being implemented in a mixed system that also uses the HumPRO™ Series modules.

Please see the HumPRO™ Series data guide for a description of the other addressing modes. A detailed explanation and examples for each addressing mode are given in Reference Guide RG-00105.

AES Encryption

HumPRC™ Series modules offer 128-bit AES encryption. Encryption algorithms are complex mathematical calculations that use a large number called a key to scramble data before transmission. This is done so that unauthorized persons who may intercept the signal cannot access the data. To decrypt the data, the receiver must use the same key that was used to encrypt it. It performs the same calculations as the transmitter and if the key is the same, the data is recovered.

The HumPRC™ Series module has the option to use AES encryption, arguably the most common encryption algorithm on the market. This is implemented in a secure mode of operation to ensure the secrecy of the transmitted data. It uses a 128-bit key to encrypt the transmitted data. The source and destination addresses are sent in the clear.

There are two ways to enable encryption and set the key: sending serial commands and using the Join Process.

Writing an encryption key to the module with the CDI

The module has no network key when shipped from the factory. An encryption key can be written to the module using the CDI. The **CMD** register is used to write or clear a key. The key cannot be read.

The same key must be written to all modules that are to be used together. If they do not have the same key, then they will not communicate in encrypted mode.

The Join Process

The Join Process can be used to generate and distribute the encryption key and addresses through a series of button presses. The key is stored in an Administrator device and the process uses a factory key to distribute the key to node devices in a secure manner. See the Join Process section for more information on this feature.

The Join Process

The Join Process is a method of generating a random encryption key and random network base address, then distributing the key and addresses to associated modules through a series of button presses. This makes it very simple to establish an encrypted network in the field or add new nodes to an existing network without any additional equipment. It is also possible to trigger the Join Process through commands on the Command Data Interface.

All modules configured from the same administrator using the Join Process can communicate with each other. Other modules are added to the network one at a time.

The hardware required is a pushbutton that is connected to the PB line. This takes the line to VCC when it is pressed and ground when it is released. An LED connected to the MODE_IND line provides visual indication of the module's state.

A module is set as an administrator by pressing and holding the button for 30 seconds to start the Generate Key function. While the button is held, the MODE_IND line is on. After 30s, the MODE_IND line repeats a double blink, indicating that the function is selected. When the button is released the key and address generation are performed and the module becomes an administrator.

An alternative way to set a module as administrator is by briefly pressing the button twice before holding it for 30 seconds. This method selects the high UART (57600 bps) data rate and high RF data rate. When other units are Joined, they will also be set to the high data rates.

When Generate Key is performed, the unit is set as the network administrator. It generates a random 128-bit AES encryption key based on ambient RF noise and scrambled by an encryption operation. If **UMASK** is the default value (0xFFFFFFFF), it is set to 0x000000FF, supporting up to 254 nodes, and **ADDMODE** is set to Extended User Address with encryption (0x27) (or without encryption (0x07) if flag PGKEY in the **SECOPT** register was set to 0 by serial command). **UMASK** and **ADDMODE** are not changed if **UMASK** is not 0xFFFFFFFF. A random 32-bit address is generated. By default, the lower 8 bits are 0, forming the network base address. Other nodes are assigned sequential addresses, starting with network base address +1. **UDESTID** is set to the bitwise OR of **USRCID** and **UMASK**, which is the network broadcast address.

A module becomes a node by joining with an administrator. This is done by pressing and releasing the PB button on both units. The modules automatically search for each other using a special protocol. When they find each other, the administrator sends the node the encryption key, UMASK and its network address. The UDESTID is set to the network broadcast address. The values are encrypted using a special factory-defined key. Once the Join Process is complete, the MODE_IND blinks on both units and they now operate together. This is shown in Figure 23 A.

If UMASK is pre-set when Generate Key is initiated, then the Join Process uses that mask and sets the address accordingly. This can allow more nodes in the network. This is shown in Figure 23 B. Likewise, the network key can be written to the module with the CDI interface. If the PGKEY bit in the SECOPT register is also set to 0, the Generate Key process will generate a network address without changing the preset key. Or the administrator can be completely configured through the CDI and the Join Process used to associate nodes in the field. This gives the system designer many options for configuration.

The SECOPT register is used to configure options related to the Join Process. This allows the OEM to set desired values at the factory and allow final network configuration in the field. This includes disabling the ability to change the address, change the key, share the key or perform a factory reset through the PB line. The built-in security prohibits changing a node to an administrator without changing the key.

Please see Reference Guide RG-00107, The HumPRO™ Series Join Process for more details and examples of the Join Process.

A) Key Generation and Network Join from Factory Default

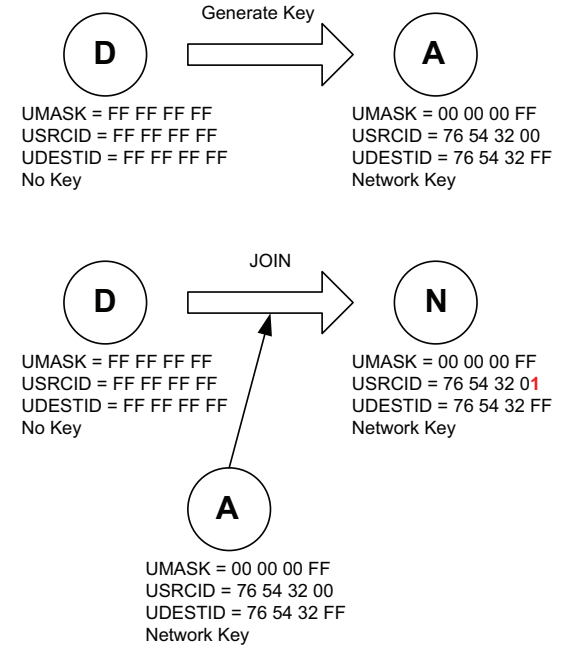

B) Key Generation and Network Join from Preset Mask

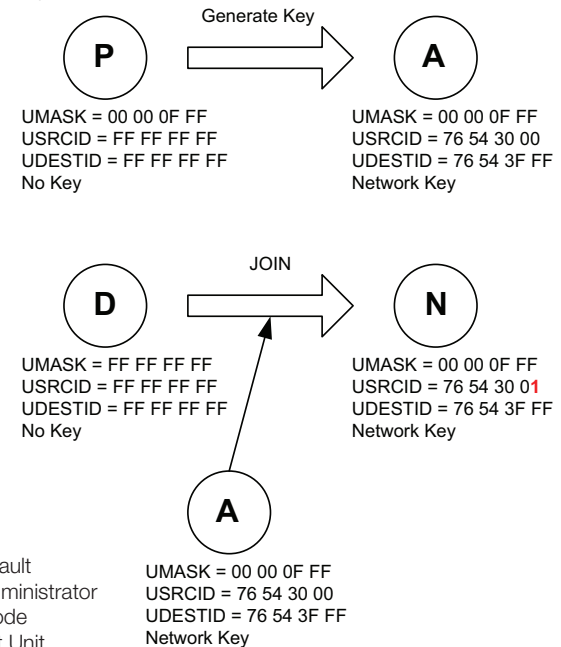

D = Factory Default
 A = Network Administrator
 N = Network Node
 P = OEM Preset Unit

UMASK = 00 00 0F FF
 USRCID = 76 54 30 00
 UDESTID = 76 54 3F FF
 Network Key

Figure 23: HumPRC™ Series and HumPRC™ Series Join Process Examples

Operation with the HumPRO™ Series

The commands from the HumPRC™ Series module can be received by a HumPRO™ Series transceiver and vice versa. The modules should be joined using the normal Join Process. The IU sends a REMOTE_ACTIVATE packet and accepts a REMOTE_CONFIRM reply.

A microcontroller connected to the HumPRO™ Series can be programmed to take action based on the STATUS byte in a REMOTE_ACTIVATE packet that is received from a HumPRC™ Series module. It can also read out the packet header and know the address of the sending module and respond with a REMOTE_CONFIRM packet to activate the ACK_OUT line on the HumPRC™ module.

Likewise, the microcontroller can be programmed to send a REMOTE_ACTIVATE packet to a HumPRC™ Series module. This opens up many options for creative mixed-mode design.

Remote Activation

The REMOTE_ACTIVATE packet consists of six bytes:

0x03 0x00 0x00 0x00 0x10 <STATUS>

The first byte is 0x03 with the next three bytes 0x00. Byte five is 0x10 which indicates a Remote Activation. Byte six is the STATUS byte, which is a bit map of the status line states. Bit 0 corresponds to status line S0 and so forth. Each bit is 1 if the corresponding line is high.

Remote Confirm

The REMOTE_CONFIRM packet has the following format:

0x03 0x00 0x00 0x00 0x11 <DURATION> <ALIVE>

The first byte is 0x03 with the next three bytes 0x00. Byte five is 0x11 and indicates that the packet is a remote confirm packet.

The DURATION byte indicates the amount of time that the ACK_OUT line should be held high. This value is multiplied by 10ms. If the value is 0, the output is immediately taken low. The default value is 0x02 for 20ms. This value overrides the effect of a previously received REMOTE_CONFIRM packet.

The ALIVE byte indicates how long after the transmission the IU module should stay awake in receive mode. This value is multiplied by 0.1s. Once this duration expires, the module returns to sleep mode.

This message is transmitted to the IU's address. It must be received by the IU within one second of initial transmission or within the ALIVE interval of the previous REMOTE_CONFIRM packet.

Carrier Sense Multiple Access (CSMA)

CSMA is an optional feature. It is a best-effort delivery system that listens to the channel before transmitting a message. If CSMA is enabled and the module detects another transmitter on the same channel, it waits until the active transmitter finishes before sending its payload. This helps to eliminate RF message corruption and make channel use more efficient.

When a module has data ready to transmit and CSMA is enabled, it listens on the intended transmit channel for activity. If no signal is detected, transmission is started.

If a carrier is detected with an RSSI above the CSMA threshold in the **CSRSSI** register, transmission is inhibited. If a signal below the threshold is detected that has a compatible preamble or packet structure, transmission is also inhibited.

If the module is synchronized from a recent packet transfer, it waits for a random interval, then checks again for activity. If the detected carrier lasts longer than the time allowed for the current channel, the module hops to the next channel in the hop sequence and again waits for a clear channel before transmitting.

If the module is not synchronized, it hops to the next channel and again checks for interference. When no activity is detected it starts transmitting.

This feature is disabled by default in the HumPRC™ so that the fastest response time is obtained. Enabling it can impact transmission timing, so care should be taken with its use.

Acknowledgement

A responding module is able to send an acknowledgement to the transmitting module. This allows the initiating module to know that the responding side received the command.

When the Responding Unit receives a valid REMOTE_ACTIVATE packet, it immediately checks the state of the ACK_EN line. If it is high the module sends a REMOTE_CONFIRM packet.

When the Initiating Unit receives a REMOTE_CONFIRM packet, it pulls the ACK_OUT line high for an amount of time specified by the REMOTE_CONFIRM packet (20ms by default).

Connecting the ACK_EN line to V_{CC} causes the RU to transmit REMOTE_CONFIRM packets as soon as it receives a valid REMOTE_ACTIVATE packet. Alternately this line can be controlled by an external circuit that raises the line when a specific action has taken place. This confirms to the IU that the action took place rather than just acknowledging receipt of the signal.

Note: Only one RU should be enabled to transmit an acknowledgement response for a given IU since multiple acknowledgements will interfere with each other.

External Amplifier Control

The HumPRC™ Series transceiver has two output lines that are designed to control external amplifiers. The PA_EN line goes high when the module activates the transmitter. This can be used to activate an external power amplifier to boost the signal strength of the transmitter. The LNA_EN line goes high when the module activates the receiver. This can be used to activate an external low noise amplifier to boost the receiver sensitivity. These external amplifiers can significantly increase the range of the system at the expense of higher current consumption and system cost.

The states of the PA_EN and LNA_EN lines can be read in the LSTATUS register. This offers a quick way to determine the current state of the radio.

Note: Adding an external power amplifier and/or low noise amplifier to the pre-certified module will invalidate its regulatory certifications.

Configuring the Status Lines

Each of the eight status lines can operate as a digital input or output. The line direction is determined by bit 0 (ENC01) in the RCCTL register. By default, this bit is 1, meaning that the status line directions are determined by the logic states of the C0 and C1 lines.

When C0 is low, S0 through S3 are outputs; when high, they are inputs. Likewise, when C1 is low, S4 through S7 are outputs; when high, they are inputs. This is shown in Figure 24. The C0 and C1 lines are sensed at power-up and when the RCCTL register is changed.

HumPRC™ Series Transceiver Status Line Direction Configuration		
Line	0	1
C0	S0 through S3 are outputs	S0 through S3 are inputs
C1	S4 through S7 are outputs	S4 through S7 are inputs

Figure 24: HumPRC™ Series Transceiver Status Line Direction Configuration

When the ENC01 bit is 0 the status line direction is determined by the RCDIR register. This register acts as a bit map of the status lines. When bit n is 1, status line Sn is an input line. When bit n is 0, status line Sn is an output line.

Using the LATCH_EN Line

The LATCH_EN line sets the outputs to either momentary operation or latched operation. During momentary operation, the outputs go high for as long as control messages are received instructing the module to take the lines high. As soon as the control messages stop, the outputs go low.

During latched operation, when a signal is received to make a particular status line high, it remains high until a separate activation is received to make it go low. The controlling line on the IU must go low then high to toggle the latched output on the RU.

Latch operation is controlled by bit 1 in the RCCTL register. When this bit is a 1 all outputs are latched. When it is a 0, the state of the LATCH_EN line sets the latching status. In this case, when the LATCH_EN line is high, all of the outputs are latched.

Restore Factory Defaults

The transceiver is reset to factory default by taking the PB line high briefly 4 times, then holding PB high for more than 3 seconds. Each brief interval must be high 0.1 to 2 seconds and low 0.1 to 2 seconds. (1 second nominal high / low cycle). The sequence helps prevent accidental resets. Once the sequence is recognized, the MODE_IND line blinks in groups of three until the PB line goes low. After PB goes low, the non-volatile configurations are set to the factory default values and the module is restarted. The default UART data rate is 9,600bps.

If the timing on PB does not match the limits, the sequence is ignored. Another attempt can be made after lowering PB for at least 3 seconds.

Using the Low Power Features

The module supports a sleep state to save current in battery-powered applications. During the sleep state, no module activity occurs and no packets can be received but current consumption is less than 1µA typical.

There are two ways of putting the module to sleep. First, pulling the Power Down (POWER_DOWN) line low puts the module to sleep. Taking the line high wakes the module. Second, all of the following should be true:

1. There is no transmission in progress
2. All status lines are low and either
 - IDLE = 1 (default) and all status lines are configured as inputs, or
 - IDLE = 2 (allows sleeping when incoming control message can be missed)
3. The internal KeepAlive timer has expired.

The internal KeepAlive timer is set by the following events:

1. On wakeup from a transition on the CMD_DATA_IN line, KeepAlive is set to 2s. This allows time for an external unit to change IDLE to 0 to keep the unit awake.
2. On each transmission, KeepAlive is set to 760ms if the remaining KeepAlive time is less. [max(760ms, KeepAlive)]

3. On reception of a REMOTE_CONFIRM packet, KeepAlive is set to received ALIVE value multiplied by 0.1s if the remaining KeepAlive time is less. The KeepAlive can be extended indefinitely by periodic reception of REMOTE_CONFIRM messages.
max(REMOTE_CONFIRM.keepAlive * 100ms, KeepAlive)

During sleep mode, the output lines are in the states in Figure 28.

HumPRC™ Series Transceiver Output Line Sleep States	
Output Line	Sleep State
S0 - S7 output	Low
LNA_EN	Low
PA_EN	Low
CMD_DATA_OUT	Low
MODE_IND	Low
ACK_OUT	Low

Figure 28: HumPRC™ Series Output Line Sleep States

When the POWER_DOWN line is high, the module awakens when a status line input goes high, the PB line goes high or there is a change on the CMD_DATA_IN lines. If a negative-going pulse is needed to generate a rising edge, the pulse width should be greater than 1 µs.

If the volatile registers have been corrupted during sleep, a software reset is performed. This restarts the module as if power were cycled. This can be caused by power surges or brownout among other things.

Pulsing RESET low causes the module to restart rather than continue from sleep.

IDLE = 1 is used when the module is an IU only. This puts it to sleep when all status line inputs are low.

IDLE = 2 is used when the module is primarily an IU, but can accept activation commands from remote units. In this case, the module stays asleep until a status line input goes high. While awake, the module can receive activation commands and will remain awake while commands are received. As soon as all status line inputs and outputs go low, the module returns to sleep.

The Command Data Interface

The HumPRC™ Series transceiver has a serial Command Data Interface (CDI) that is used to configure and control the transceiver through software commands. This interface consists of a standard UART with a serial command set. The CMD_DATA_IN and CMD_DATA_OUT lines are the interface to the module's UART. The UART is configured for 1 start bit, 1 stop bit, 8 data bits, no parity and a serial data rate set by register **UARTBAUD** (default 9,600bps).

Configuration settings are stored in two types of memory inside the module. Volatile memory is quick to access, but it is lost when power is removed from the module. Non-volatile memory has a limited number of write cycles, but is retained when power is removed. When a configuration parameter has both a non-volatile and volatile register, the volatile register controls the operation unless otherwise stated. The non-volatile register holds the default value that is loaded into the volatile register on power-up.

Configuration settings are read from non-volatile memory on power up and saved in volatile memory. The volatile and non-volatile registers have different address locations, but the same read and write commands. The two locations can be changed independently.

The general serial command format for the module is:

[FF] [Length] [Command]

The Length byte is the number of bytes in the Command field. The Command field contains the register address that is to be accessed and, in the case of a write command, the value to be written. Neither Length nor Command can contain a 0xFF byte.

Byte values of 128 (0x80) or greater can be sent as a two-byte escape sequence of the format:

0xFE, [value - 0x80]

For example, the value 0x83 becomes 0xFE, 0x03. The Length count includes the added escape bytes.

A response is returned for all valid commands. The first response byte is CMD_ACK (0x06) or CMD_NACK (0x15). Additional bytes may follow, as determined by the specific command.

Reading from Registers

A register read command is constructed by placing an escape character (0xFE) before the register number. The module responds by sending an ACK (0x06) followed by the register number and register value. The register value is sent unmodified, so if the register value is 0x83, 0x83 is returned. If the register number is invalid, the module responds with a NACK (0x15). The command and response are shown in Figure 29.

HumPRC™ Series Read From Configuration Register				
Command				
Header	Size	Escape	Address	
0xFF	0x02	0xFE	REG	
Response				
ACK	Address	Value		
0x06	REG	V		
Command for an Address greater than 128 (0x80)				
Header	Size	Escape	Addr1	Addr2
0xFF	0x03	0xFE	0xFE	REG-80
Response				
ACK	Address	Value		
0x06	REG	V		

Figure 29: HumPRC™ Series Read from Configuration Register Command and Response

Writing to Registers

To allow any byte value to be written, values of 128 (0x80) or greater can be encoded into a two-byte escape sequence of the format 0xFE, [value - 0x80]. This includes register addresses as well as values to be written to the registers. The result is that there are four possible packet structures because of the possible escape sequences. These are shown in Figure 30.

HumPRC™ Series Write to Configuration Register Command					
Register and Value less than 128 (0x80)					
Header	Size	Address	Value		
0xFF	0x02	REG	V		
Register less than 128 (0x80) and a Value greater than or equal to 128 (0x80)					
Header	Size	Address	Escape	Value	
0xFF	0x03	REG	0xFE	V-0x80	
Register greater than or equal to 128 (0x80) and a Value less than 128 (0x80)					
Header	Size	Escape	Address	Value	
0xFF	0x03	0xFE	REG-0x80	V	
Register and Value greater than or equal to 128 (0x80)					
Header	Size	Escape	Address	Escape	Value
0xFF	0x04	0xFE	REG-0x80	0xFE	V-0x80

Figure 30: HumPRC™ Series Write to Configuration Register Command

Generally, there are three steps to creating the command.

1. Determine the register address and the value to be written.
2. Encode the address and value as either the number (N) or the encoded number (0xFE, N-0x80) as appropriate.
3. Add the header (0xFF) and the size.

The module responds with an ACK (0x06). If the ACK is not received, the command should be resent. The module responds with a NACK (0x15) if a write is attempted to a read-only or invalid register.

As an example, to write 01 to register 0x83, send

FF 03 FE 03 01

Note: The non-volatile memory has a life expectancy with a limited number of refresh cycles. Please see the electrical specifications.

Command Length Optimization

Some commands may be shortened by applying the following rules:

1. Escape sequences are not required for byte values 0x00 to 0xEF (besides 0xFE and 0xFF, bytes 0xF0 – 0xFD are reserved for future use).
2. An escape byte inverts bit 7 of the following data byte.
3. The 0xFE as the first byte of the Read Register Command field is an escape byte.
4. Two consecutive escape bytes cancel unless the following data byte is 0xf0-0xff.

Examples:

- FF 02 FE 02 (read nv:TXPWR) is equivalent to FF 01 82.
- FF 03 FE FE 53 (read v:PKOPT) is equivalent to FF 01 53.
- FF 03 1A FE 7F (write FF to nv:UMASK0) cannot be shortened.
- FF 03 1A FE 40 (write C0 to nv:UMASK0) is equivalent to FF 02 1A C0.

These rules are implemented in the sample code file EncodeProCmd.c, which can be downloaded from the Linx website.

Example Code for Encoding Read/Write Commands

This software example is provided as a courtesy in “as is” condition. Linx Technologies makes no guarantee, representation, or warranty, whether express, implied, or statutory, regarding the suitability of the software for use in a specific application. The company shall not, in any circumstances, be liable for special, incidental, or consequential damages, for any reason whatsoever.

File EncodeProCmd.c

```
/* Sample C code for encoding HUM-fff-PRO commands
**
** Copyright 2015 Linx Technologies
** 159 Ort Lane
** Merlin, OR, US 97532
** www.linxtechnologies.com
**
** License:
** Permission is granted to use and modify this code, without royalty, for
** any purpose, provided the copyright statement and license are included.
*/

#include "EncodeProCmd.h"

/* Function: HumProCommand
** Description: This function encodes a command byte sequence.
** If len = 1, a read command is generated.
** If len > 1, a write command is generated.
** rcmd[0] = register number
** rcmd[1..(n-1)] = bytes to write
*/
unsigned char HumProCommand( /* number of encoded bytes, n+2 to 2*n+2 */
    unsigned char *ecmd, /* out: encoded command, length >= 2*n + 2 */
    const unsigned char *rcmd, /* in: sequence of bytes to encode */
    unsigned char n /* number of bytes in rcmd, 1..32 */
){
    unsigned char dx; /* destination index */
    unsigned char sx; /* source index */
    unsigned char v; /* value to be encoded */
    dx = 2;
    sx = 0;
    while (n--) {
        v = rcmd[sx++];
        if (v >= 0xf0) {
            ecmd[dx++] = 0xfe;
            v &= 0x7f;
        }
        ecmd[dx++] = v;
    }
    ecmd[0] = 0xff;
    ecmd[1] = dx - 2;
}
```

```
return dx;
}

/* Function: HumProRead
** Description: This function encodes a read command to the specified
** register address.
*/
unsigned char HumProRead( /* number of encoded bytes, 3 to 4 */
    unsigned char *cmd, /* out: encoded read command, length >= 4 */
    unsigned char reg /* register number to read, 0..0xff */
){
    unsigned char ra; /* read register byte */

    ra = reg ^ 0x80;
    return HumProCommand(cmd, &ra, 1);
}

/* Function: HumProWrite
** Description: This function encodes a command to write a single byte to
** a specified register address.
*/
unsigned char HumProWrite( /* number of encoded bytes, 4 to 6 */
    unsigned char *cmd, /* out: encoded read command, length >= 6 */
    unsigned char reg, /* register number to write, 0..0xff */
    unsigned char val /* value byte, 0..0xff */
){
    unsigned char cs[2];
    cs[0] = reg;
    cs[1] = val;
    return HumProCommand(cmd, &cs, 2);
}
```

The Command Data Interface Command Set

The following sections describe the registers.

HumPRC™ Series Configuration Registers					
Name	NV Addr	Vol Addr	R/W	Default Value	Description
CRCERRS		0x40	R/W	0x00	CRC Error Count
HOPTABLE	0x00	0x4B	R/W	0xFF	Channel Hop Table
TXPWR	0x02	0x4D	R/W	0x03	Transmit Power
UARTBAUD	0x03	0x4E	R/W	0x01	UART data rate
ADDMODE	0x04	0x4F	R/W	0x0F	Addressing mode
DATATO	0x05	0x50	R/W	0x10	Data timeout
MAXTXRETRY	0x07	0x52	R/W	0x02	Maximum Transmit Retries
ENCRC	0x08	0x53	R/W	0x01	Enable CRC checking
BCTRIG	0x09	0x54	R/W	0x40	Byte Count trigger
ENCSMA	0x0B	0x56	R/W	0x01	Enable CSMA
IDLE	0x0D	0x58	R/W	0x01	Idle Mode
WAKEACK	0x0E	0x59	R/W	0x01	UART Acknowledge on Wake
UDESTID3	0x0F	0x5A	R/W	0xFF	Destination Address for User Packet Type, extended
UDESTID2	0x10	0x5B	R/W	0xFF	Destination Address for User Packet Type, extended
UDESTID1	0x11	0x5C	R/W	0xFF	Destination Address for User Packet Type
UDESTID0	0x12	0x5D	R/W	0xFF	Destination Address for User Packet Type
USRCID3	0x13	0x5E	R/W	0xFF	Source Address for User Packet Type, extended
USRCID2	0x14	0x5F	R/W	0xFF	Source Address for User Packet Type, extended
USRCID1	0x15	0x60	R/W	0xFF	Source Address for User Packet Type
USRCID0	0x16	0x61	R/W	0xFF	Source Address for User Packet Type
UMASK3	0x17	0x62	R/W	0xFF	Address Mask for User Packet Type, extended
UMASK2	0x18	0x63	R/W	0xFF	Address Mask for User Packet Type, extended
UMASK1	0x19	0x64	R/W	0xFF	Address Mask for User Packet Type
UMASK0	0x1A	0x65	R/W	0xFF	Address Mask for User Packet Type
DESTDSN3	0x1D	0x68	R/W	0xFF	Destination Device Serial Number
DESTDSN2	0x1E	0x69	R/W	0xFF	Destination Device Serial Number
DESTDSN1	0x1F	0x6A	R/W	0xFF	Destination Device Serial Number
DESTDSN0	0x20	0x6B	R/W	0xFF	Destination Device Serial Number

RCCTL	0x22	0x6D	R/W	0x01	RC control
CMDHOLD	0x23	0x6E	R/W	0x01	Hold RF data when nCMD pin is low
RCDIR	0x24	0x6F	R/W	0xFF	RC status line direction select
COMPAT	0x25	0x70	R/W	0x02	Compatibility
AUTOADDR	0x26	0x71	R/W	0x07	Automatic Reply Address
MYDSN3	0x34		R		Factory programmed Serial Number
MYDSN2	0x35		R		Factory programmed Serial Number
MYDSN1	0x36		R		Factory programmed Serial Number
MYDSN0	0x37		R		Factory programmed Serial Number
CUSTID1	0x39		R	0xFF	Factory programmed customer ID
CUSTID0	0x3A		R	0xFF	Factory programmed customer ID
CSRSSI	0x3F		R/W	0xBA	Carrier Sense minimum RSSI
RELEASE	0x78		R		Release number
RCCLS		0x7A	R	0x00	RC status line state
PRSSI		0x7B	R	0x00	Packet RSSI
ARSSI		0x7C	R	0x00	Ambient RSSI
FWVER3	0xC0		R		Firmware version, major
FWVER2	0xC1		R		Firmware version, minor
FWVER1	0xC2		R		Firmware version, increment
FWVER0	0xC3		R		Firmware version, suffix
NVCYCLE1	0xC4		R		NV Refresh Cycles, MS
NVCYCLE0	0xC5		R		NV Refresh Cycles, LS
LSTATUS		0xC6	R		Status lines
CMD		0xC7	W	0x00	Command register
SECSTAT		0xC9	R		Security Status
JOINST		0xCA	R	0x00	Join Status
EEXFLAG2		0xCD	R/W	0x00	Extended exception flags
EEXFLAG1		0xCE	R/W	0x00	Extended exception flags
EEXFLAG0		0xCF	R/W	0x00	Extended exception flags
EEXMASK2	0x80	0xD0	R/W	0x00	Extended exception mask
EEXMASK1	0x81	0xD1	R/W	0x00	Extended exception mask
EEXMASK0	0x82	0xD2	R/W	0x00	Extended exception mask
PKTOPT	0x83	0xD3	R/W	0x01	Packet options
SECOPT	0x84	0xD4	R/W	0xFF	Security Options
LASTNETAD[3]	0x8C		R/W	0x00	Last Network Address Assigned
LASTNETAD[2]	0x8D		R/W	0x00	Last Network Address Assigned
LASTNETAD[1]	0x8E		R/W	0x00	Last Network Address Assigned
LASTNETAD[0]	0x8F		R/W	0x00	Last Network Address Assigned

Figure 31: HumPRC™ Series Configuration Registers

CRCERRS - CRC Error Count

Volatile Address = 0x40

The value in the CRCERRS register is incremented each time a packet with a valid header is received that fails the CRC check on the payload. This check applies only to unencrypted packets. Overflows are ignored. Writing 0x00 to this register initializes the count. Figure 32 shows the command and response.

HumPRC™ Series CRC Error Count							
Read Command				Read Response			
Header	Size	Escape	Address	ACK	Address	Value	
0xFF	0x02	0xFE	0x40	0x06	0x40	V	
Write Command							
Header	Size	Address	Value				
0xFF	0x02	0x40	V				

Figure 32: HumPRC™ Series CRC Error Count Command and Response

HOPTABLE - Channel Hop Table

Volatile Address = 0x4B; Non-Volatile Address = 0x00

The module supports 6 different hop sequences with minimal correlation. The sequence is set by the value in the HOPTABLE register. Changing the hop sequence changes the band utilization, much the same way that a channel does for a non-hopping transmitter. The hop table selection must match between the transmitter and receiver. Valid values are 0-5. The default value of 0xFF must be changed before communication can occur. This is normally done by the Join Process. Figure 33 shows the command and response.

HumPRC™ Series Channel Hop Table							
Read Command				Read Response			
Header	Size	Escape	Address	ACK	Address	Value	
0xFF	0x02	0xFE	0x4B 0x00	0x06	0x4B 0x00	V	
Write Command							
Header	Size	Address	Value				
0xFF	0x02	0x4B 0x00	V				

Figure 33: HumPRC™ Series Channel Hop Table Command and Response

Figure 34 shows the RF channels used by the HumPRC™ Series. When the baud rate is set to 9,600 or 19,200 bps, the module uses 50 hopping channels. Figure 35 shows the hop sequences referenced by channel number. When the baud rate is 38,400bps and higher, the module uses 26 hopping channels and only even channels are used. Figure 36 shows the hop sequences referenced by channel number. The default hop sequence is 0.

HumPRC™ Series RF Channels			
Channel Number	Frequency (MHz)	Channel Number	Frequency (MHz)
0	902.971	32	915.000
1	903.347	33	915.376
2	903.723	34	915.752
3	904.099	35	916.128
4	904.475	36	916.504
5	904.851	37	916.880
6	905.227	38	917.255
7	905.602	39	917.631
8	905.978	40	918.007
9	906.354	41	918.383
10	906.730	42	918.759
11	907.106	43	919.135
12	907.482	44	919.511
13	907.858	45	919.887
14	908.234	46	920.263
15	908.610	47	920.639
16	908.986	48	921.014
17	909.361	49	921.390
18	909.737	50	921.766
19	910.113	51	922.142
20	910.489	52	922.518
21	910.865	53	922.894
22	911.241	54	923.270
23	911.617	55	923.646
24	911.993	56	924.022
25	912.369	57	924.398
26	912.745	58	924.773
27	913.120	59	925.149
28	913.496	60	925.525
29	913.872	61	925.901
30	914.248	62	926.277
31	914.624	63	926.653

Figure 34: HumPRC™ Series RF Channels

HumPRC™ Series Hop Sequences by Channel Number for 19,200bps and below					
0	1	2	3	4	5
25	30	11	58	52	35
63	60	12	11	10	23
28	59	0	52	54	41
26	14	62	37	62	45
16	16	23	36	21	7
61	32	43	42	33	42
4	4	25	25	44	63
29	47	34	15	51	24
0	26	61	1	61	9
44	43	26	55	36	27
46	1	24	2	34	10
22	25	6	12	2	17
36	36	31	26	57	20
34	15	7	27	50	22
24	57	32	41	12	18
2	10	55	9	29	32
21	48	39	8	6	3
11	21	1	31	8	8
27	8	41	49	46	15
1	17	29	13	48	4
35	37	15	47	11	0
37	45	57	14	39	48
55	44	3	33	4	13
8	13	42	48	45	61
10	33	47	38	22	31
54	0	2	45	56	56
13	46	56	59	18	52
32	62	33	3	43	54
43	34	9	46	60	55
12	7	14	0	31	62
23	24	30	39	47	6
48	22	21	57	0	37
14	58	4	56	20	36
39	42	54	5	37	38
40	50	59	40	59	51
15	12	51	23	35	59
57	20	22	62	7	5
18	39	38	24	15	43
60	27	58	54	25	21
41	2	60	17	16	40
9	35	52	22	23	14
49	5	45	32	42	12
58	28	37	7	24	30
38	49	13	61	32	16
45	29	35	34	28	34
56	18	36	63	26	46
50	38	8	50	13	60
42	3	46	30	3	39
62	52	40	43	5	58
47	40	49	28	49	33

Figure 35: HumPRC™ Series Hop Sequences for UART rate of 19,200bps and below

HumPRC™ Series Hop Sequences by Channel Number for 38,400bps and Above					
0	1	2	3	4	5
32	30	6	56	44	18
2	60	40	22	14	48
4	58	42	20	16	46
10	52	48	14	22	40
20	42	58	4	32	30
42	20	16	46	54	8
22	40	60	2	34	28
46	16	20	42	58	4
28	34	2	60	40	22
58	4	32	30	6	56
54	8	28	34	2	60
44	18	18	44	56	6
24	38	62	0	36	26
48	14	22	40	60	2
34	28	8	54	46	16
6	56	44	18	18	44
14	48	52	10	26	36
30	32	4	58	42	20
62	0	36	26	10	52
60	2	34	28	8	54
56	6	30	32	4	58
50	12	24	38	62	0
38	24	12	50	50	12
12	50	50	12	24	38
26	36	0	62	38	24
52	10	26	36	0	62

Figure 36: HumPRC™ Series Hop Sequences for UART rates of 38,400bps and above

TXPWR - Transmitter Output Power

Volatile Address = 0x4D; Non-Volatile Address = 0x02

The value in the TXPWR register sets the module's output power. Figure 37 shows the command and response and Figure 38 available power settings and typical power outputs for the module. The default setting is 0x03.

HumPRC™ Series Transmitter Output Power Mode							
Read Command				Read Response			
Header	Size	Escape	Address	ACK	Address	Value	
0xFF	0x02	0xFE	0x4D 0x02	0x06	0x4D 0x02	PWR	
Write Command							
Header	Size	Address	Value				
0xFF	0x02	0x4D 0x02	PWR				

Figure 37: HumPRC™ Series Transmitter Output Power Mode Command and Response

HumPRC™ Series Transmitter Output Power Mode Register Settings	
PWR	Typical Output Power (dBm)
0x00	-5
0x01	0
0x02	+5
0x03	+9

Figure 38: HumPRC™ Series Transmitter Output Power Mode Settings

ADDMODE - Addressing Mode

Volatile Address = 0x4F; Non-Volatile Address = 0x04

This register is controlled automatically by the HumPRC™ application and the Join Process, so should not be changed by external commands.

DATATO - Transmit Wait Timeout

Volatile Address = 0x50; Non-Volatile Address = 0x05

This register selects options for transferring packet data in the HumPRO™ Series. These options are controlled automatically by the HumPRC™ application and do not have any effect on its operation.

UARTBAUD - UART Baud Rate

Volatile Address = 0x4E; Non-Volatile Address = 0x03

The value in UARTBAUD sets the data rate of the UART interface. Changing the non-volatile register changes the data rate on the following power-up or reset. Changing the volatile register changes the data rate immediately following the command acknowledgement. Figure 39 shows the command and response and Figure 40 shows the valid settings.

HumPRC™ Series UART Baud Rate							
Read Command				Read Response			
Header	Size	Escape	Address	ACK	Address	Value	
0xFF	0x02	0xFE	0x4E 0x03	0x06	0x4E 0x03	V	
Write Command							
Header	Size	Address	Value				
0xFF	0x02	0x4E 0x03	V				

Figure 39: HumPRC™ Series UART Baud Rate Command and Response

HumPRC™ Series UART Baud Rate Register Settings		
V	Baud Rate (bps)	RF Data Rate (bps)
0x01	9,600	19,200
0x02	19,200	19,200
0x03	38,400	153,600
0x04	57,600	153,600
0x05	115,200	153,600
0x06	10,400*	153,600
0x07	31,250*	153,600

* These data rates are not supported by PC serial ports. Selection of these rates may cause the module to fail to respond to a PC, requiring a reset to factory defaults.

Figure 40: HumPRC™ Series UART Baud Rate Settings

If the module's UART baud rate is different than the host processor UART baud rate then the module will not communicate correctly. If mismatched, every rate can be tested until the correct one is found or the module can be reset to factory defaults. The default baud rate is 9,600bps (0x01).

MAXTXRETRY - Maximum Transmit Retries

Volatile Address = 0x52; Non-Volatile Address = 0x07

The value in the MAXTXRETRY register sets the number of transmission retries performed if an acknowledgement is not received. If an acknowledgement is not received after the last retry, exception EX_NORFACK is raised. Figure 41 shows examples of the command.

HumPRC™ Series Maximum Transmit Retries						
Read Command				Read Response		
Header	Size	Escape	Address	ACK	Address	Value
0xFF	0x02	0xFE	0x52 0x07	0x06	0x52 0x07	V
Write Command						
Header	Size	Address	Value			
0xFF	0x02	0x52 0x07	V			

Figure 41: HumPRC™ Series Maximum Transmit Retries Command and Response

The time between retries depends on the current baud rate. Figure 42 shows the time between retries based on baud rate. The elapsed transmit and acknowledgment time is $(\text{retries} + 1) \times (\text{PacketTransmitTime} + \text{Timeout})$.

HumPRC™ Series Acknowledgement Timeout Times	
Baud Rate	Timeout Time
9,600	50ms
19,200	50ms
38,400	30ms
57,600	30ms
115,200	30ms

Figure 42: HumPRC™ Series Acknowledgement Timeout Times

ENCRC - CRC Enable

Volatile Address = 0x53; Non-Volatile Address = 0x08

The protocol includes a Cyclic Redundancy Check (CRC) on the received unencrypted packets to make sure that there are no errors. Encrypted packets use a key-based error detection method. Any packets with errors are discarded and not output on the UART. This feature can be disabled if it is desired to perform error checking outside the module. Set the ENCRC register to 0x01 to enable CRC checking, or 0x00 to disable it. The default CRC mode setting is enabled. Figure 43 shows examples of the commands and Figure 44 shows the available values.

HumPRC™ Series CRC Enable						
Read Command				Read Response		
Header	Size	Escape	Address	ACK	Address	Value
0xFF	0x02	0xFE	0x53 0x08	0x06	0x53 0x08	V
Write Command						
Header	Size	Address	Value			
0xFF	0x02	0x53 0x08	V			

Figure 43: HumPRC™ Series CRC Enable Command and Response

HumPRC™ Series CRC Enable Register Settings	
V	Mode
0x00	CRC Disabled
0x01	CRC Enabled

Figure 44: HumPRC™ Series CRC Enable Register Settings

Although disabling CRC checking allows receiving packets with errors in the payload, errors in the header can still prevent packets from being output by the module.

BCTRIG - UART Byte Count Trigger

Volatile Address = 0x54; Non-Volatile Address = 0x09

This register selects options for transferring packet data in the HumPRO™ Series. These options are controlled automatically by the HumPRC™ application and do not have any effect on its operation.

ENCSMA - CSMA Enable

Volatile Address = 0x56; Non-Volatile Address = 0x0B

Carrier-Sense Multiple Access (CSMA) is a best-effort transmission protocol that listens to the channel before transmitting a message. If another device is already transmitting on the same channel when a message is ready to send, the module waits before sending its payload or changes to an unused channel. This helps to eliminate RF message corruption at the expense of additional latency. By default, CSMA is enabled. Figure 45 shows examples of the commands and Figure 46 shows the available values.

HumPRC™ Series CSMA Enable							
Read Command				Read Response			
Header	Size	Escape	Address	ACK	Address	Value	
0xFF	0x02	0xFE	0x56 0x0B	0x06	0x56 0x0B	V	
Write Command							
Header	Size	Address	Value				
0xFF	0x02	0x56 0x0B	V				

Figure 45: HumPRC™ Series CSMA Enable Command and Response

HumPRC™ Series CSMA Enable Register Settings	
V	Mode
0x00	Disable CSMA
0x01	Enable CSMA

Figure 46: HumPRC™ Series CSMA Enable Register Settings

See the [Carrier Sense Multiple Access](#) section for details.

IDLE - Idle Mode

Volatile Address = 0x58; Non-Volatile Address = 0x0D

The value in the IDLE register sets the operating mode of the transceiver. If the module remains properly powered, and is awakened from a low power mode properly, the volatile registers retain their values. If the volatile registers become corrupted during low power, a software reset is forced and the module reboots.

Awake is the normal operating setting. This is the only setting in which the RF circuitry is able to receive and transmit RF messages.

Sleep disables all circuitry on-board the module. This is the lowest-power setting available for the module.

Please see the [Low Power States](#) section for more details. Figure 47 shows examples of the commands and Figure 48 shows the available values.

HumPRC™ Series Idle Mode							
Read Command				Read Response			
Header	Size	Escape	Address	ACK	Address	Value	
0xFF	0x02	0xFE	0x58 0x0D	0x06	0x58 0x0D	V	
Write Command							
Header	Size	Address	Value				
0xFF	0x02	0x58 0x0D	V				

Figure 47: HumPRC™ Series Idle Mode Command and Response

HumPRC™ Series Idle Mode Register Settings	
V	Mode
0x00	Awake
0x01	Sleep when all status lines are inputs and low
0x02	Sleep when all status lines are low

Figure 48: HumPRC™ Series Idle Mode Register Settings

WAKEACK - ACK on Wake

Volatile Address = 0x59; Non-Volatile Address = 0x0E

When UART Acknowledge on Wake is enabled, the module sends an ACK (0x06) character out of the CMD_DATA_OUT line after the module resets or wakes from sleep. This indicates that the module is ready to accept data and commands. A value of 0x01 enables this feature; 0x00 disables it. The default value is 0x01. Figure 49 shows examples of the commands and Figure 50 shows the available values.

HumPRC™ Series ACK on Wake						
Read Command				Read Response		
Header	Size	Escape	Address	ACK	Address	Value
0xFF	0x02	0xFE	0x59 0x0E	0x06	0x59 0x0E	V
Write Command						
Header	Size	Address	Value			
0xFF	0x02	0x59 0x0E	V			

Figure 49: HumPRC™ Series ACK on Wake Command and Response

HumPRC™ Series ACK on Wake Register Settings	
V	Mode
0x00	Disable ACK
0x01	Enable ACK

Figure 50: HumPRC™ Series ACK on Wake Register Settings

UDESTID - User Destination Address

Volatile Address = 0x5A-0x5D; Non-Volatile Address = 0x0F-0x12

These registers contain the address of the destination module when User Addressing mode or Extended User Addressing mode are enabled. User Addressing mode uses bytes 0 and 1 to determine the destination address. Extended User Addressing mode uses all four bytes. These registers are automatically filled with the source address from a received message if the received message address type matches the value in [AUTOADDR](#). Please see the [Addressing Modes](#) section for more details. Each register byte is read and written separately. Figure 51 shows the User Destination ID registers.

HumPRC™ Series User Destination Address Registers			
Name	Volatile Address	Non-Volatile Address	Description
UDESTID3	0x5A	0x0F	MSB of the extended destination address
UDESTID2	0x5B	0x10	Byte 2 of the extended destination address
UDESTID1	0x5C	0x11	Byte 1 of the extended destination address, MSB of the short destination address
UDESTID0	0x5D	0x12	LSB of the extended destination address and short destination address

Figure 51: HumPRC™ Series User Destination Address Registers

USRCID - User Source Address

Volatile Address = 0x5E-0x61; Non-Volatile Address = 0x13-0x16

These registers contain the address of the module when User Addressing mode or Extended User Addressing mode are enabled. User Addressing mode uses bytes 0 and 1 to determine the source address for both transmitted messages and matching received messages. Extended User Addressing mode uses all four bytes. When the [COMPAT](#) register is 0x02 in User Address mode, bytes 3 and 2 must be 0. Please see the [Addressing Modes](#) section for more details. Each register byte is read and written separately. Figure 52 shows the User Source ID registers.

HumPRC™ Series User Source Address Registers			
Name	Volatile Address	Non-Volatile Address	Description
USRCID3	0x5E	0x13	MSB of the extended source address
USRCID2	0x5F	0x14	Byte 2 of the extended source address
USRCID1	0x60	0x15	Byte 1 of the extended source address MSB of the short source address
USRCID0	0x61	0x16	LSB of the extended source address and short source address

Figure 52: HumPRC™ Series User Source Address Registers

UMASK - User ID Mask

Volatile Address = 0x62-0x65; Non-Volatile Address = 0x17-0x1A

These registers contain the user ID mask when User Addressing mode or Extended User Addressing mode are enabled. Please see the [Addressing Modes](#) section for more details. Each register byte is read and written separately.

Figure 53 shows the User ID Mask registers.

HumPRC™ Series User ID Mask Registers			
Name	Volatile Address	Non-Volatile Address	Description
UMASK3	0x62	0x17	MSB of the extended mask
UMASK2	0x63	0x18	Byte 2 of the extended mask
UMASK1	0x64	0x19	Byte 1 of the extended mask MSB of the short mask
UMASK0	0x65	0x1A	LSB of the extended mask and short mask

Figure 53: HumPRC™ Series User ID Mask Registers

DESTDSN - Destination Serial Number

Volatile Address = 0x68-0x6B; Non-Volatile Address = 0x1D-0x20

These registers contain the serial number of the destination module when DSN Addressing Mode is enabled. Please see the [Addressing Modes](#) section for more details. Each register byte is read and written separately.

Figure 54 shows the Destination DSN registers.

HumPRC™ Series Destination DSN Registers			
Name	Volatile Address	Non-Volatile Address	Description
DESTDSN3	0x68	0x1D	MSB of the destination DSN
DESTDSN2	0x69	0x1E	Byte 2 of the destination DSN
DESTDSN1	0x6A	0x1F	Byte 1 of the destination DSN
DESTDSN0	0x6B	0x20	LSB of the destination DSN

Figure 54: HumPRC™ Series Destination DSN Registers

RCCTL - RC Control

Volatile Address = 0x6D; Non-Volatile Address = 0x22

This register controls RC behavior.

HumPRC™ Series RC Control						
Read Command				Read Response		
Header	Size	Escape	Address	ACK	Address	Value
0xFF	0x02	0xFE	0x6D 0x22	0x06	0x6D 0x22	V
Write Command						
Header	Size	Address	Value			
0xFF	0x02	0x6D 0x22	V			

Figure 55: HumPRC™ Series RC Control Command and Response

HumPRC™ Series RC Control Values	
RCCTL Bit	Control
0	ENC01 – Enable C0 and C1 control inputs
1	LATCHOP – latch outputs
2	Reserved
3	Reserved
4	Reserved
5	Reserved
6	Reserved
7	Reserved

Figure 56: HumPRC™ Series RC Control Register Settings

When ENC01 is 1, the C0 and C1 lines control the status line direction. When 0, register RCDIR controls the status line direction. Please see the [Configuring the Status Lines](#) section for more details.

When LATCHOP is 1, all output status lines are latched, regardless of the LATCH_EN line state. When 0, the LATCH_EN line determines the latching status of the output lines.

CMDHOLD - $\overline{\text{CMD}}$ Halts Traffic

Volatile Address = 0x6E; Non-Volatile Address = 0x23

This register selects options for transferring packet data in the HumPRO™ Series. These options are controlled automatically by the HumPRC™ application and do not have any effect on its operation.

COMPAT - Compatibility Mode

Volatile Address = 0x70; Non-Volatile Address = 0x25

This register selects options for transferring packet data in the HumPRO™ Series. These options are controlled automatically by the HumPRC™ application and do not have any effect on its operation.

AUTOADDR - Auto Addressing

Volatile Address = 0x71; Non-Volatile Address = 0x26

This register is controlled automatically by the HumPRC™ application, so should not be changed by external commands.

RCDIR - RC Status Line Direction Select

Volatile Address = 0x6F; Non-Volatile Address = 0x24

This register controls the direction of the associated status line. When bit n is 1, status line Sn is an input line. When bit n is 0, status line Sn is an output line.

HumPRC™ Series RC Status Line Direction Select						
Read Command				Read Response		
Header	Size	Escape	Address	ACK	Address	Value
0xFF	0x02	0xFE	0x6F 0x24	0x06	0x6F 0x24	V
Write Command						
Header	Size	Address	Value			
0xFF	0x02	0x6F 0x24	V			

Figure 57: HumPRC™ Series Transceiver RC Status Line Direction Select Command and Response

On startup, if the ENC01 bit in the RCCTL register is 0, v:RCDIR is set to nv:RCDIR. If ENC01 is 1 on startup, nv:RCDIR is set by control lines C0 and C1.

An attempt to write this register when nv:RCCTL.ENC01 = 1 results in a CMD_NACK response.

HumPRC™ Series RC Status Line Direction Select Values		
RCDIR Bit	Status Line	Value
0	S0 Direction	0 = Output 1 = Input
1	S1 Direction	
2	S2 Direction	
3	S3 Direction	
4	S4 Direction	
5	S5 Direction	
6	S6 Direction	
7	S7 Direction	

Figure 58: HumPRC™ Series Transceiver RC Status Line Direction Select Values

MYDSN - Local Device Serial Number

Non-Volatile Address = 0x34-0x37

These registers contain the factory-programmed read-only Device Serial Number. This address is unique for each module and is included in all packet types as a unique origination address.

Figure 59 shows the Device Serial Number registers.

HumPRC™ Series DSN Registers		
Name	Non-Volatile Address	Description
MYDSN3	0x34	MSB of the serial number
MYDSN2	0x35	Byte 2 of the serial number
MYDSN1	0x36	Byte 1 of the serial number
MYDSN0	0x37	LSB of the serial number

Figure 59: HumPRC™ Series DSN Registers

CUSTID - Customer ID

Non-Volatile Address = 0x39-0x3A

These registers contain the factory-programmed customer ID. A unique value is assigned to a specific customer and that value is programmed into that customer's modules. The unencrypted User and Extended User Addressing modes use these bytes as part of the addressing. The unique value ensures that the custom modules will not communicate with any other systems. Contact Linx for details. Figure 60 shows the Customer ID registers.

HumPRC™ Series Customer ID Registers		
Name	Non-Volatile Address	Description
CUSTID1	0x39	MSB of the customer ID
CUSTID0	0x3A	LSB of the customer ID

Figure 60: HumPRC™ Series Transceiver Customer ID Registers

CSRSSI - Carrier Sense Minimum RSSI

Non-Volatile Address = 0x3F

This value is the minimum RSSI that causes the module to wait for a clear channel when CSMA is enabled. Figure 61 shows examples of the commands.

HumPRC™ Series Carrier Sense Minimum RSSI						
Read Command				Read Response		
Header	Size	Escape	Address	ACK	Address	Value
0xFF	0x02	0xFE	0x3F	0x06	0x3F	V
Write Command						
Header	Size	Address	Value			
0xFF	0x02	0x3F	V			

Figure 61: HumPRC™ Series Transceiver Carrier Sense Minimum RSSI Command and Response

The value is a negative number in two's complement from -128 (0x80) to -1 (0xff). The default value is -70dBm.

Warning: The CSRSSI value can have a significant impact on the performance of the module. Setting it too low could prevent the module from ever transmitting. Setting it too high can result in transmission collisions. Care must be taken if this value is adjusted.

RELEASE - Release Number

Non-Volatile Address = 0x78

This register contains a number designating the firmware series and hardware platform. Figure 62 shows examples of the commands and Figure 63 lists current releases to date.

HumPRC™ Series Release Number						
Read Command				Read Response		
Header	Size	Escape	Address	ACK	Address	Value
0xFF	0x02	0xFE	0x78	0x06	0x78	V

Figure 62: HumPRC™ Series Transceiver Release Number Command and Response

HumPRC™ Series Release Number Register Settings	
V	Release Number
0x24	HUM-868-PRC
0x25	HUM-900-PRC

Figure 63: HumPRC™ Series Transceiver Release Number Register Settings

A more detailed firmware version is available for versions 0x20 and above in the FWVER register.

RCCLS - RC Status Line States

Volatile Address = 0x7A

This register contains the debounced state of the status lines. When status line Sn is high, bit n is 1. When low, bit n is 0. The register reflects the state of both input and output status lines.

Figure 64 shows examples of the commands.

HumPRC™ Series RC Status Line States						
Read Command				Read Response		
Header	Size	Escape	Address	ACK	Address	Value
0xFF	0x02	0xFE	0x7A	0x06	0x7A	V

Figure 64: HumPRC™ Series Transceiver RC Status Line States Command and Response

PRSSI - Last Good Packet RSSI

Volatile Address = 0x7B

This register holds the received signal strength in dBm of the last successfully received packet. A successful packet reception is one that causes payload data to be output on the UART interface. The value in this register is overwritten each time a new packet is successfully processed. The register value is an 8-bit signed integer representing the RSSI in dBm. It is accurate to ± 3 dB.

HumPRC™ Series Last Good Packet RSSI							
Read Command				Read Response			
Header	Size	Escape	Address	ACK	Address	Value	
0xFF	0x02	0xFE	0x7B	0x06	0x7B	V	

Figure 65: HumPRC™ Series Transceiver Last Good Packet RSSI Command and Response

ARSSI - Ambient RSSI

Volatile Address = 0x7C

This register returns the ambient receive signal strength on the current channel in dBm. The signal strength is measured as soon as the command is received. The register value is an 8-bit signed integer representing the RSSI in dBm. It is accurate to ± 3 dB at the high RF data rate, and +3 to -20 dB at the low RF data rate. The channel being read may be any of the channels in the selected hopping sequence.

HumPRC™ Series Ambient RSSI							
Read Command				Read Response			
Header	Size	Escape	Address	ACK	Address	Value	
0xFF	0x02	0xFE	0x7C	0x06	0x7C	V	

Figure 66: HumPRC™ Series Transceiver Ambient RSSI Command and Response

FWVER - Firmware Version

Non-Volatile Address = 0xC0 - 0xC3

These read-only registers contain the firmware version number currently on the module. Each byte is a hexadecimal value: 12 03 01 00 indicates version 18.3.1.0. Each register byte is read separately. Figure 67 shows the Firmware Version registers.

HumPRC™ Series Firmware Version Registers		
Name	Non-Volatile Address	Description
FWVER3	0xC0	Major version number
FWVER2	0xC1	Minor version number
FWVER1	0xC2	Incremental version number
FWVER0	0xC3	Suffix

Figure 67: HumPRC™ Series Firmware Version Registers

NVCYCLE - Non-Volatile Refresh Cycles

Non-Volatile Address = 0xC4-0xC5

These read-only non-volatile registers contain the number of lifetime refresh cycles performed for the non-volatile memory. The minimum lifetime refreshes is 2,000 refresh cycles. Beyond this the refreshes may not be complete and the module's operation can become unpredictable.

HumPRC™ Series Non-Volatile Refresh Cycles Registers		
Name	Non-Volatile Address	Description
NVCYCLE1	0xC4	MSB of the number of refresh cycles
NVCYCLE0	0xC5	LSB of the number of refresh cycles

Figure 68: HumPRC™ Series Non-Volatile Refresh Cycles Registers

Between 8 and 150 non-volatile write operations can be made before a refresh cycle is necessary. Writing the registers from lowest to highest address maximizes the number of write operations per refresh cycle.

It is recommended to write the desired default values to non-volatile memory and use the volatile registers for values that change frequently.

These registers show the total number of refresh cycles that have occurred. This gives an indication of the remaining life expectancy of the memory. Figure 68 shows the Non-Volatile Refresh Cycles registers.

LSTATUS - Output Line Status

Volatile Address = 0xC6

This register contains the logic states of the HumPRO™ indicator lines. Many of these status lines are not connected to an external line in the HumPRC™ Series, but this register shows their logical state. Please see the HumPRO™ Series Data guide for a full description of these lines.

HumPRC™ Series Output Line Status								
Read Command					Read Response			
Header	Size	Escape	Escape	Address	ACK	Address	Value	
0xFF	0x03	0xFE	0xFE	0x46	0x06	0xC6	LSTATUS	

Figure 69: HumPRC™ Series Transceiver Output Line Status Command and Response

Each bit in the byte that is returned by the read represents the logic state of one of the output indicator lines. Figure 70 shows which line each bit represents.

HumPRC™ Series Output Line Status LSTATUS Values	
LSTATUS Bit	Line Status
0	EX – Exception, 1 = exception has occurred
1	PA_EN – PA Enable, 1 = the transmitter is active
2	LNA_EN – LNA Enable, 1 = the receiver is active
3	$\overline{\text{CTS}}$ – Clear To Send, undefined
4	MODE_IND – Mode Indicator, 1 = RF data transfer is active (TX or RX)
5	BE – Buffer Empty, 1 = UART buffer is empty
6	ACK_OUT – Acknowledgement Output, 1 = ACK was received
7	Reserved, 0

Figure 70: HumPRC™ Series Output Line Status LSTATUS Values

CMD - Command Register

Volatile Address = 0xC7

This volatile write-only register is used to issue special commands.

HumPRC™ Series Command Register				
Write Command				
Header	Size	Escape	Address	Value
0xFF	Size	0xFE	0x47	V

Figure 71: HumPRC™ Series Transceiver Command Register Command and Response

Value V is chosen from among the options in Figure 72.

HumPRC™ Series CMD Values	
CMD Value	Operation
0x10	JOINCTL – Join Process Control
0x11	WRKEY – Write Key
0x12	CLRKEY – Clear Key
0x13	RLDKEY – Reload Key
0x20 0xAA 0xBB	NVRESET – Reset non-volatile registers to factory default

Figure 72: HumPRC™ Series Command Register Values

The **Join Process Control** command allows the software to initiate or stop the secure [Join process](#). It has the following subcommands.

HumPRC™ Series JOINCTL Subcommand Values	
Subcommand Value	Operation
0	Halt Join Process
1	Generate a random network key and address. This sets the module as the network administrator (SECOPT:KEYRCV=0)
2	Perform the Join Process with another module

Figure 73: HumPRC™ Series JOINCTL Subcommand Values

These operations are equivalent to the push-button initiated operation. If the Join Process is started by the serial command (CMD:JOINCTL[2]), push-button operation is ignored until the Join Process finishes.

Register write operations are inhibited when a Join Process is active except that a Halt Join command is never inhibited. A Halt Join operation completes before the ACK is sent.

When the Join Process is started the KEYRCV flag in the [SECOPT](#) register determines whether the module is an administrator or node and whether a key can be sent or changed. The Join Process uses and modifies the non-volatile address registers. After a successful Join, the modified non-volatile registers are copied to the corresponding volatile registers.

The **Write Key** command writes a 16-byte AES key to the selected key register. As with most of the registers, the encryption key has both volatile and non-volatile registers. The volatile register is used during run time, but is lost on a power cycle or reset. When the module powers up, the volatile register is loaded from the non-volatile register. This makes the non-volatile register value the default on power-up.

The key value of all zero bytes is reserved as a “no key” indication.

Figure 74 shows the command for writing the AES key to the module. If KeyN is 0x01, the command writes to the volatile key register. If it is 0x02,

HumPRC™ Series Write Key Command								
Write Command								
Header	Size	Escape	Address	Value	KeyN	Key0	...	Key15
0xFF	Size	0xFE	0x47	0x11	KeyN	Key0	...	Key15

Figure 74: HumPRC™ Series Transceiver Write Key Command

it writes to the non-volatile key register.

The **Clear Key** command sets the selected key to all zeros. Figure 75 shows the structure of this command.

If KeyN is 0x01, the command clears the volatile key registers. If it is 0x02,

HumPRC™ Series Clear Key Command					
Write Command					
Header	Size	Escape	Address	Value	KeyN
0xFF	0x04	0xFE	0x47	0x12	KeyN

Figure 75: HumPRC™ Series Transceiver Clear Key Command

it clears the non-volatile key registers.

The **Reload Key** command copies the key in non-volatile memory (NKN)

to the volatile location (NKV). This allows a sophisticated system to change the keys during operation and quickly revert back to the default key.

The **Non-volatile Reset** command (FF 07 FE 47 20 FE 2A FE 3B) sets all non-volatile registers to their default values. When the configuration is reset, the following message, shown in quotes, is sent out the UART at the current baud rate, then the module is reset, similar to a power cycle:

“\r\nConfiguration Reset\r\n”.

This reset can also be done by toggling the PB line as described in the [Restore Factory Defaults](#) section.

SECSTAT - Security Status

Volatile Address = 0xC9

This volatile read-only register provides status of the security features. The command returns a single byte. Figure 77 shows the meanings of the

HumPRC™ Series Security Status							
Read Command					Read Response		
Header	Size	Escape	Escape	Address	ACK	Address	Value
0xFF	0x03	0xFE	0xFE	0x49	0x06	0xC9	V

Figure 76: HumPRC™ Series Transceiver Security Status Command and Response

bits in the returned value byte.

HumPRC™ Series Security Status Value	
Bit	Status
0	Reserved
1	0 = No volatile key is set 1 = A volatile key is set
2	0 = No non-volatile key is set 1 = A non-volatile key is set
3	Reserved
4	Reserved
5	Reserved
6	Reserved
7	Reserved

Figure 77: HumPRC™ Series Security Status Values

JOINST - Join Status

Volatile Address = 0xCA

This volatile read-only register shows the current or previous state of Join activity since the module was last reset.

HumPRC™ Series Join Status							
Read Command					Read Response		
Header	Size	Escape	Escape	Address	ACK	Address	Value
0xFF	0x03	0xFE	0xFE	0x4A	0x06	0xCA	V

Figure 78: HumPRC™ Series Transceiver Join Status Command and Response

The command returns a single byte. Figure shows the meanings of the returned value byte.

HumPRC™ Series Join Status Value		
Bit	Status	
0 - 5	Last Join Result (decimal): Last Operation Successful 0x00: Module unpaired since restart 0x01: New key generated 0x02: Successfully sent address to another unit 0x03: Successfully sent address and key to another unit 0x04: Successfully obtained key from administrator 0x05: Successfully obtained address from administrator 0x06: Successfully obtained key and address from administrator 0x07: New address generated without key 0x08: New key generated without address Last Operation Failed 0x0A: Fail: operation canceled 0x0B: Fail: timeout 0x0C: Fail: Invalid Generate Key and Address request 0x0D: Fail: Assignment message didn't contain key 0x0E: Fail: Administrator has no key to send when SECOPT:PSHARE=1 0x0F: Fail: Administrator has no address to send 0x10: Fail: Inconsistent Network Address Registers USRC, UMASK, LASTNETAD 0x11: Fail: LASTNETAD overflow 0x12: Fail: GET_KEY key and address change disabled.	
	6	+0x40: JOINACT – MODE_IND is active with pairing status, serial write operations are inhibited

Figure 79: HumPRC™ Series Transceiver Join Status Value

EEXFLAG - Extended Exception Flags

Volatile Address = 0xCD - 0xCF

These volatile registers contain flags for various events. They provide a separate bit for each exception.

HumPRC™ Series Extended Exception Flags Registers		
Name	Volatile Address	Description
EEXFLAG2	0xCD	Byte 2 of the extended exception flags
EEXFLAG1	0xCE	Byte 1 of the extended exception flags
EEXFLAG0	0xCF	LSB of the extended exception flags

Figure 80: HumPRC™ Series Transceiver Extended Exception Code Registers

When an exception occurs, the associated bit is set in this register. If the corresponding bit in the EEXMASK is set and EXMASK is zero, the EX status line is set. Reading an EEXFLAG register does not clear the register.

Writing to an EEXFLAG register causes the register to be set to the BIT_AND(current_value, new_value). This provides a way of clearing bits that have been serviced without clearing a bit that has been set since the flag register was read. This prevents a loss of notification of an exception.

Register bits can only be cleared, not set, from the write command though some flags are also cleared internally. Unless otherwise noted, exceptions are cleared by writing a zero to the corresponding register bit.

Flag **EX_TXDONE** is set when a data packet has been transmitted. If the packet was sent with acknowledgement enabled, this flag indicates that the acknowledgment has also been received.

Flag **EX_RXWAIT** is 1 when there are buffered incoming data bytes which have not been sent to the UART. It is cleared automatically by the HumPRC™ application.

Flag **EX_UNENCRYPT** is 1 when a received packet is not encrypted. This can only occur when SECOPT:EN_UNC=1.

Flag **EX_SEQDEC** is 1 when a received encrypted packet has a smaller sequence number than the previously received packet. Possible causes are an attempt to replay a previous message by an attacker, receiving a message from a different transmitter or restarting the transmitter.

Flag **EX_SEQSKIP** is 1 when a received encrypted packet has a sequence number that is more than one higher than the previously received packet. Possible causes are an attempt to replay a previous message by an attacker, receiving a message from a different transmitter or restarting the transmitter.

HumPRC™ Series Transceiver Extended Exception Codes		
Bit	Exception Name	Description
EEXFLAG0 (0xCF)		
0	EX_BUFOVFL	Internal UART buffer overflowed.
1	EX_RFOVFL	Internal RF packet buffer overflowed.
2	EX_WRITEREGFAILED	Attempted write to register failed.
3	EX_NORFACK	Acknowledgement packet not received after maximum number of retries.
4	EX_BADCRC	Bad CRC detected on incoming packet.
5	EX_BADHEADER	Bad CRC detected in packet header.
6	EX_BADSEQID	Sequence ID was incorrect in ACK packet.
7	EX_BADFRAMETYPE	Unsupported frame type specified.
EEXFLAG1 (0xCE)		
0	EX_TXDONE	A data packet has been transmitted.
1	EX_RXWAIT	Received data bytes are waiting to be read.
2	EX_UNENCRYPT	Received packet was not encrypted. This can only occur when SECOPT: EN_UNC=1.
3	EX_SEQDEC	Received encrypted packet sequence number is less than previous.
4	EX_SEQSKIP	Received encrypted sequence number is more than one higher the previous sequence number.
5	EX_JOIN	The Join Process has been started, which can result in register changes and write lockouts.
6 - 7	Reserved	
EEXFLAG2 (0xCD)		
0 - 7	Reserved	

Figure 81: HumPRC™ Series Transceiver Extended Exception Codes

EEXMASK - Extended Exception Mask

Volatile Address = 0xD0-0xD2; Non-Volatile Address = 0x80-0x82

These registers contain a mask for the events in EEXFLAG, using the same offset and bit number.

HumPRC™ Series Extended Exception Mask Registers			
Name	Volatile Address	Non-Volatile Address	Description
EEXMASK2	0xD0	0x80	Byte 2 of the extended exception mask
EEXMASK1	0xD1	0x81	Byte 1 of the extended exception mask
EEXMASK0	0xD2	0x82	Byte 0 of the extended exception mask

Figure 82: HumPRC™ Series Transceiver Extended Exception Mask Registers

To use this value, register EXMASK must be zero. If EXMASK is non-zero, this register has no effect on the EX line.

When an exception bit is set in EEXFLAG, the corresponding EEXMASK bit is set, and EXMASK is zero, the EX status line is set, otherwise the EX line is reset. Mask bits for unassigned flags should be zero for future compatibility.

PKTOPT - Packet Options

Volatile Address = 0xD3; Non-Volatile Address = 0x83

This register selects options for transferring packet data in the HumPRO™ Series. These options are controlled automatically by the HumPRC™ application and do not have any effect on its operation.

LASTNETAD - Last Network Address Assigned

Non-Volatile Address = 0x8C-0x8F

These bytes contain the last address assigned using the Join Process. When a new unit joins the network, it is assigned the next address and this value is incremented in the administrator. It is initially set to the administrator address when a network key is generated.

HumPRC™ Series Extended Exception Mask Registers		
Name	Non-Volatile Address	Description
LASTNETAD3	0x8C	MSB of the last network address assigned
LASTNETAD2	0x8D	Byte 2 of the last network address assigned
LASTNETAD1	0x8E	Byte 1 of the last network address assigned
LASTNETAD0	0x8F	LSB of the last network address assigned

Figure 83: HumPRC™ Series Transceiver Extended Exception Mask Registers

SECOPT - Security Options

Volatile Address = 0xD4; Non-Volatile Address = 0x84

This register selects options for security features.

HumPRC™ Series Security Options									
Read Command					Read Response				
Header	Size	Escape	Escape	Address	ACK	Address	Value		
0xFF	0x03	0xFE	0xFE	0x54 0x04	0x06	0xD4 0x84	V		
Write Command									
Header	Size	Escape	Address	Value					
0xFF	0x03	0xFE	0x54 0x04	V					

Figure 84: HumPRC™ Series Transceiver Packet Options Command and Response

Each bit in the register sets an option as shown in Figure 85. Unlike other registers, the non-volatile register (0x84) affects all Join operations. The EN_UNENC bit in the volatile register affects data packet reception.

HumPRC™ Series Transceiver Security Option Codes		
Bit	Name	Description
0	PB_RESET	Permit factory reset from PB input sequence
1	PSHARE	Permit key sharing
2	PGKEY	Permit clearing key and changing key
3	CHGADDR	Permit changing an address
4	KEYRCV	1: Receive key and address during Join Process (node) 0: Send key and address during Join Process (admin)
5	EN_UNENC	Enable receiving unencrypted packets
6	Reserved	Reserved (must be 1)
7	EN_CHANGE	Enable changes to security options

Figure 85: HumPRC™ Series Transceiver Security Option Codes

When PB_RESET is 1 the Factory Reset function is enabled from the PB input. This allows a user to reset the module configurations back to the factory defaults with 4 short presses and a 3 second hold of a button connected to the PB input.

When PSHARE is 1 the Share Network Key function is enabled during the Join Process. This allows an administrator to share the encryption key it created. When 0, a Join Process sends the network address, but no key.

When PGKEY is 1 the Join Process is allowed to change or clear the network key. The key can always be changed through serial commands.

When CHGADDR is 1 the Join Process is allowed to generate a random network address if the module is an administrator. If the module is a node it is allowed to accept an address assignment from the administrator.

When KEYRCV is 1 the module is set to receive a network key from an administrator and act as a node. When it is 0, the module is set as an administrator and sends a network key and assigns an address to the node.

In order for this bit to change from 1 to 0, both volatile and non-volatile copies of the network key must be cleared, preventing nodes from being manipulated to transmit the key. This bit is cleared by the GENERATE_KEY push-button function.

When EN_UNENC is 1 the module accepts unencrypted packets. If this bit is 0, unencrypted received packets are ignored.

When EN_CHANGE is 1, changes are permitted to the SECOPT register, except as noted for KEYRCV changes.

Clearing this bit prohibits the following SECOPT changes to enhance security:

1. changing PSHARE from 0 to 1
2. changing EN_CHANGE from 0 to 1.
3. changing EN_UNENC from 0 to 1.

An attempt to make a prohibited change causes a NACK command response.

When EN_CHANGE is 0, these restrictions can only be removed by resetting the module configuration to the factory default.

Typical Applications

The following steps describe how to use the HumPRC™ Series module with hardware only.

1. Set the C0 and C1 lines opposite on both sides.
2. Press and hold the PB button for 30s on the unit chosen as Administrator. When MODE_IND flashes, release PB. The unit is set as the Administrator.
3. Press the PB button on both sides. The MODE_IND LED begins flashing slowly to indicate that the module is searching for another module.
4. Once the pairing is complete, the MODE_IND LED flashes quickly to indicate that the pairing was successful.
5. The modules are now paired and ready for normal use.
6. Pressing a status line button on one module (the IU) activates the corresponding status line output on the second module (the RU).
7. Taking the ACK_EN line high on the RU causes the module to send an acknowledgement to the IU. The ACK_OUT line on the IU goes high to indicate that the acknowledgement has been received. Tying the line to V_{cc} causes the module to send an acknowledgement as soon as a command message is received.

This is suitable for basic remote control or command systems. No programming is necessary for basic hardware operation.

Basic application circuits for one-way remote control are shown in Figure 86. Circuits for bi-directional remote control are shown in Figure 87.

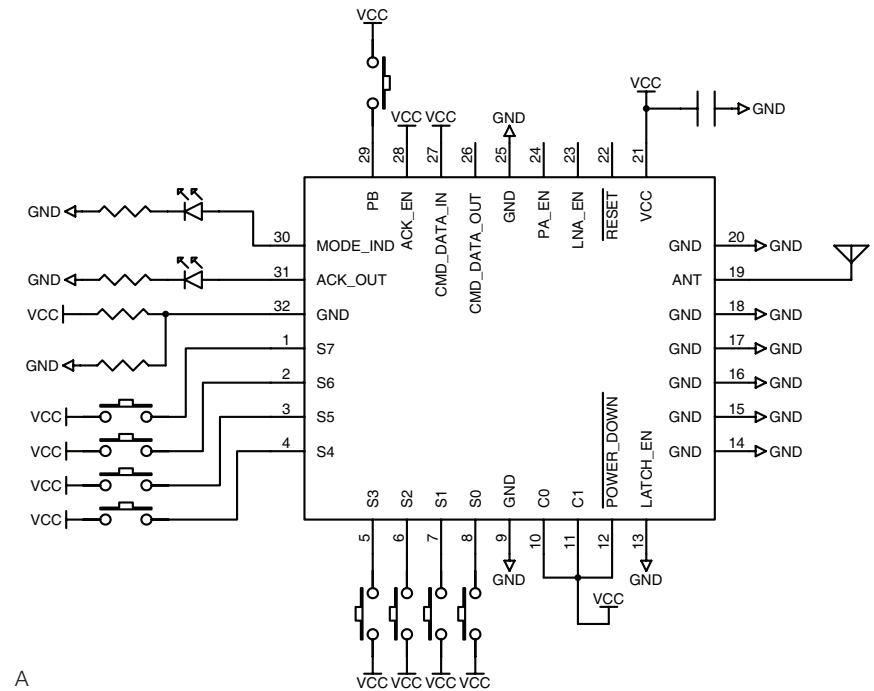

A

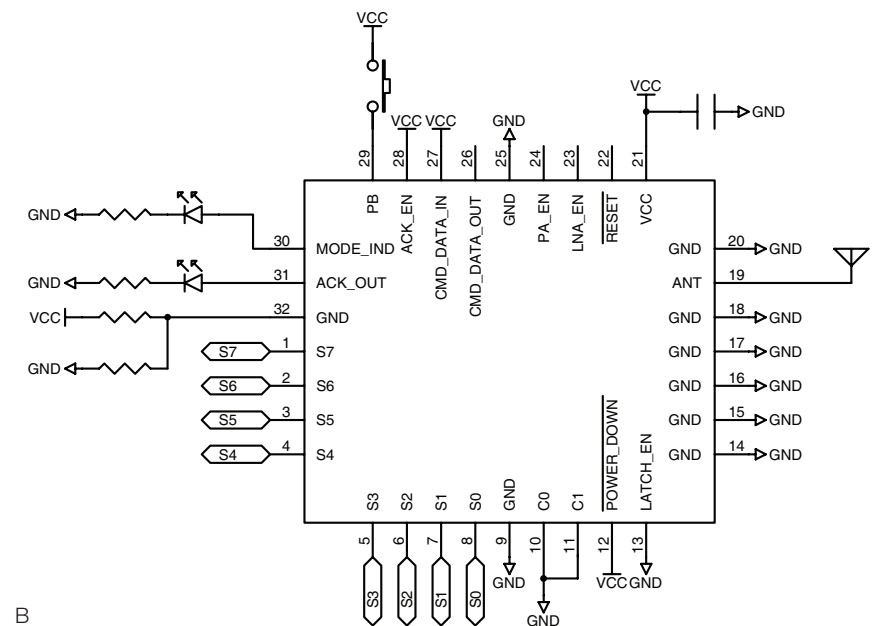

B

Figure 86: HumPRC™ Series Transceiver Basic Application Circuits for Remote Control

HumPRC™ Series Long-Range Handheld Transmitter

The HumPRC™ Series Long-Range Handheld Transmitter is ideal for general-purpose remote control and command applications. It incorporates the HumPRC™ Series remote control transceiver, antenna and a coin-cell battery into a plastic enclosure. A membrane switch array is used to activate the unit. An LED embedded into the membrane switch indicates acknowledgement from the remote device. It has a transmission range of up to 1,300m (0.8 mile) depending on the receiver antenna and operating environment.



The transmitter is available in 868MHz and 900MHz for multi-region operation. The 868MHz version has been tested to European ETSI requirements and received its CE mark. The 900MHz version has been certified by the United States FCC and Industry Canada. This reduces development costs and time to market.



The membrane switch array can be customized to have specific artwork, logos, colors, number of buttons (up to eight) and button positions. A one-time NRE is required to create the custom switch, but minimum order quantities can be as low as 200

pieces. Contact Linx for more information.

Key Features

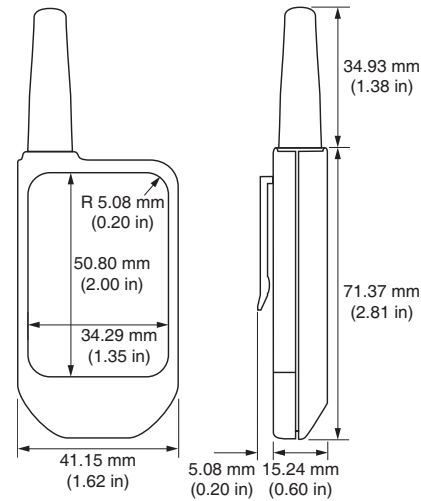

Small Package

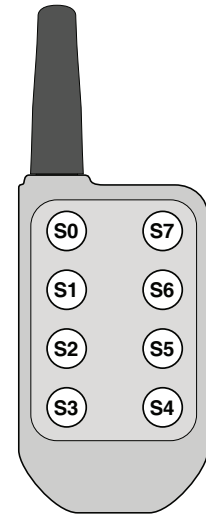

Up to 8 buttons

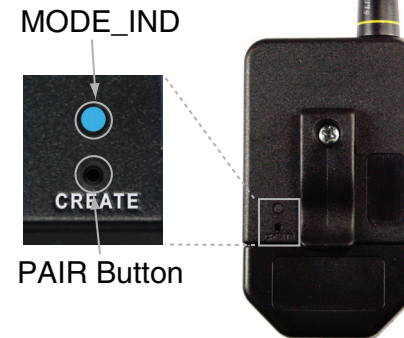

PAIR Button

Join Process Pairing



CR2032 Coin Cell Battery

Ordering Information

Part Number	Description
OTX-***-HH-LR8-PRC	HumPRC™ Long-Range Handheld Transmitter
*** = 868, 900MHz	

Figure 89: HumPRC™ Series Long-Range Handheld Transmitter Ordering Information

Usage Guidelines for FCC Compliance

The pre-certified versions of the HumPRC™ Series module (HUM-900-PRC-UFL and HUM-900-PRC-CAS) are provided with an FCC and Industry Canada Modular Certification. This certification shows that the module meets the requirements of FCC Part 15 and Industry Canada license-exempt RSS standards for an intentional radiator. The integrator does not need to conduct any further intentional radiator testing under these rules provided that the following guidelines are met:

- An approved antenna must be directly coupled to the module's U.FL connector through an approved coaxial extension cable or to the module's castellation pad using an approved reference design and PCB layer stack.
- Alternate antennas can be used, but may require the integrator to perform certification testing.
- The module must not be modified in any way. Coupling of external circuitry must not bypass the provided connectors.
- End product must be externally labeled with "Contains FCC ID: OJM900MCA / IC: 5840A-900MCA".
- The end product's user's manual must contain an FCC statement equivalent to that listed on page 85 of this data guide.
- The antenna used for this transceiver must not be co-located or operating in conjunction with any other antenna or transmitter.
- The integrator must not provide any information to the end-user on how to install or remove the module from the end-product.

Any changes or modifications not expressly approved by Linx Technologies could void the user's authority to operate the equipment.

Additional Testing Requirements

The HUM-900-PRC-UFL and HUM-900-PRC-CAS have been tested for compliance as an intentional radiator, but the integrator is required to perform unintentional radiator testing on the final product per FCC sections 15.107 and 15.109 and Industry Canada license-exempt RSS standards. Additional product-specific testing might be required. Please contact the FCC or Industry Canada regarding regulatory requirements for the application. Ultimately it is the integrator's responsibility to show that their product complies with the regulations applicable to their product. **Versions other than the -UFL and -CAS have not been tested and require full compliance testing in the end product as it will go to market.**

Information to the User

The following information must be included in the product's user manual.

FCC / IC NOTICES

This product contains FCC ID: OJM900MCA / IC: 5840A-900MCA.

This device complies with Part 15 of the FCC rules and Industry Canada license-exempt RSS standards. Operation of this device is subject to the following two conditions:

1. This device may not cause harmful interference, and
2. this device must accept any interference received, including interference that may cause undesired operation.

This equipment has been tested and found to comply with the limits for a Class B digital device, pursuant to Part 15 of the FCC Rules. These limits are designed to provide reasonable protection against harmful interference in a residential installation. This equipment generates, uses and can radiate radio frequency energy and, if not installed and used in accordance with the instructions, may cause harmful interference to radio communications. However, there is no guarantee that interference will not occur in a particular installation. If this equipment does cause harmful interference to radio or television reception, which can be determined by turning the equipment off and on, the user is encouraged to try to correct the interference by one or more of the following measures:

- Reorient or relocate the receiving antenna.
- Increase the separation between the equipment and receiver.
- Connect the equipment into an outlet on a circuit different from that to which the receiver is connected.
- Consult the dealer or an experienced radio/TV technician for help.

Any modifications could void the user's authority to operate the equipment.

Le présent appareil est conforme aux CNR d'Industrie Canada applicables aux appareils radio exempts de licence. L'exploitation est autorisée aux deux conditions suivantes:

1. l'appareil ne doit pas produire de brouillage, et
2. l'utilisateur de l'appareil doit accepter tout brouillage radioélectrique subi, même si le brouillage est susceptible d'en compromettre le fonctionnement.

Product Labeling

The end product containing the HUM-900-PRC-UFL or HUM-900-PRC-CAS must be labeled to meet the FCC and IC product label requirements. It must have the below or similar text:

Contains FCC ID: OJM900MCA / IC: 5840A-900MCA

The label must be permanently affixed to the product and readily visible to the user. “Permanently affixed” means that the label is etched, engraved, stamped, silkscreened, indelibly printed, or otherwise permanently marked on a permanently attached part of the equipment or on a nameplate of metal, plastic, or other material fastened to the equipment by welding, riveting, or a permanent adhesive. The label must be designed to last the expected lifetime of the equipment in the environment in which the equipment may be operated and must not be readily detachable.

FCC RF Exposure Statement

To satisfy RF exposure requirements, this device and its antenna must operate with a separation distance of at least 20cm from all persons and must not be co-located or operating in conjunction with any other antenna or transmitter.

Antenna Selection

Under FCC and Industry Canada regulations, the HUM-900-PRC-UFL and HUM-900-PRC-CAS radio transmitters may only operate using an antenna of a type and maximum (or lesser) gain approved for the transmitter by the FCC and Industry Canada. To reduce potential radio interference to other users, the antenna type and its gain should be so chosen that the equivalent isotropically radiated power (e.i.r.p.) is not more than that necessary for successful communication.

The HUM-900-PRC-UFL and HUM-900-PRC-CAS radio transmitters have been approved by the FCC and Industry Canada to operate with the antenna types listed in Figure 90 with the maximum permissible gain and required antenna impedance for each antenna type indicated. Antenna types not included in this list, having a gain greater than the maximum gain indicated for that type, are strictly prohibited for use with this device.

Conformément à la réglementation d’Industrie Canada, le présent émetteur radio peut fonctionner avec une antenne d’un type et d’un gain maximal (ou inférieur) approuvé pour l’émetteur par Industrie Canada. Dans le but de réduire les risques de brouillage radioélectrique à l’intention des autres

utilisateurs, il faut choisir le type d’antenne et son gain de sorte que la puissance isotrope rayonnée équivalente (p.i.r.e.) ne dépasse pas l’intensité nécessaire à l’établissement d’une communication satisfaisante.

Le présent émetteur radio (HUM-900-PRC-UFL, HUM-900-PRC-CAS) a été approuvé par Industrie Canada pour fonctionner avec les types d’antenne énumérés la Figure 90 et ayant un gain admissible maximal et l’impédance requise pour chaque type d’antenne. Les types d’antenne non inclus dans cette liste, ou dont le gain est supérieur au gain maximal indiqué, sont strictement interdits pour l’exploitation de l’émetteur.

Antennas / Antennes				
Linx Part Number Référence Linx	Type	Gain	Impedance Impédance	Valid For
Tested Antennas				
ANT-916-CW-QW	¼ Wave Whip	1.8dBi	50Ω	–CAS
ANT-916-CW-HW	½ Wave Dipole Helical	1.2dBi	50Ω	Both
ANT-916-PW-LP	¼ Wave Whip	2.4dBi	50Ω	–CAS
ANT-916-PW-QW-UFL	¼ Wave Whip	1.8dBi	50Ω	–UFL
ANT-916-SP	¼ Wave Planar	1.4dBi	50Ω	–CAS
ANT-916-WRT-RPS ANT-916-WRT-UFL	½ Wave Dipole Helical	–0.1dBi	50Ω	–CAS –UFL
Antennas of the same type and same or lesser gain				
ANT-916-CW-HD	¼ Wave Whip	–0.3dBi	50Ω	Both
ANT-916-PW-QW	¼ Wave Whip	1.8dBi	50Ω	Both
ANT-916-CW-RCL	¼ Wave Whip	–2.0dBi	50Ω	Both
ANT-916-CW-RH	¼ Wave Whip	–1.3dBi	50Ω	Both
ANT-916-CW-HWR-RPS	½ Wave Dipole Helical	1.2dBi	50Ω	Both
ANT-916-PML	½ Wave Dipole Helical	–0.4dBi	50Ω	Both
ANT-916-PW-RA	¼ Wave Whip	0.0dBi	50Ω	–CAS
ANT-916-USP	¼ Wave Planar	0.3dBi	50Ω	–CAS
Cable Assemblies / Assemblages de Câbles				
Linx Part Number Référence Linx	Description			
CSI-RSFB-300-UFFR*	RP-SMA Bulkhead to U.FL with 300mm cable			
CSI-RSFE-300-UFFR*	RP-SMA External Mount Bulkhead to U.FL with 300mm cable			
* Also available in 100mm and 200mm cable length				

Figure 90: HumPRC™ Series Transceiver Approved Antennas

Castellation Version Reference Design

The castellation connection for the antenna on the pre-certified version allows the use of embedded antennas as well as removes the cost of a cable assembly for the U.FL connector. However, **the PCB design and layer stack must follow one of the reference designs for the certification on the HUM-900-PRC-CAS to be valid.** Figure 91 shows the PCB layer stack that should be used. Figure 92 shows the layout and routing designs for the different antenna options. Please see the antenna data sheets for specific ground plane counterpoise requirements.

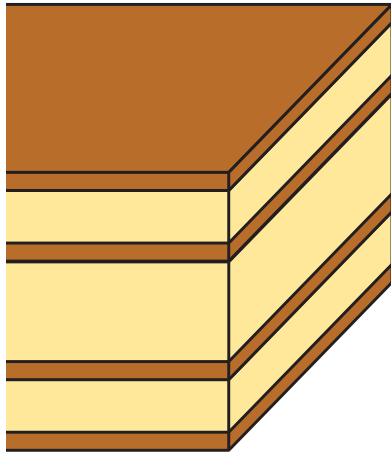

Layer Name	Thickness	Material
Top Layer	1.4mil	Copper
Dielectric 1	14.00mil	FR-4 (Er = 4.6)
Mid-Layer 1	1.4mil	Copper
Dielectric 2	28.00mil	FR-4 (Er = 4.6)
Mid-Layer 2	1.4mil	Copper
Dielectric 3	14.00mil	FR-4 (Er = 4.6)
Bottom Layer	1.4mil	Copper

Figure 91: HumPRC™ Series Transceiver Castellation Version Reference Design PCB Stack

Note: The PCB design and layer stack for the HUM-900-PRC-CAS must follow these reference designs for the pre-certification to be valid.

The HUM-900-PRC-UFL and the HUM-900-PRC-CAS must use one of the antennas in Figure 108 in order for the certification to be valid.

The HUM-900-PRC has not been tested and requires full compliance testing in the end product as it will go to market.

All modules require unintentional radiator compliance testing in the end product as it will go to market.

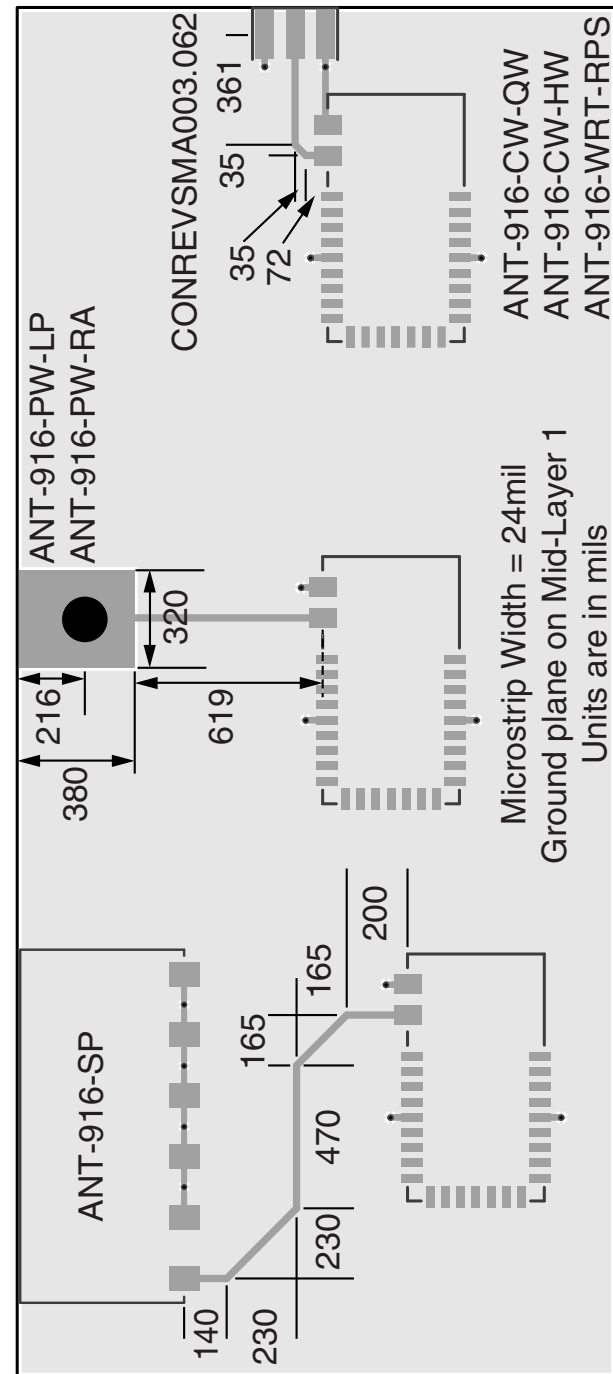

Figure 92: HumPRC™ Series Transceiver Castellation Version Reference Design

Power Supply Requirements

The module does not have an internal voltage regulator, therefore it requires a clean, well-regulated power source. The power supply noise should be less than 20mV. Power supply noise can significantly affect the module's performance, so providing a clean power supply for the module should be a high priority during design.

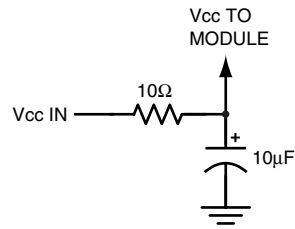

Figure 93: Supply Filter

A 10Ω resistor in series with the supply followed by a 10μF tantalum capacitor from V_{cc} to ground helps in cases where the quality of supply power is poor (Figure 93). This filter should be placed close to the module's supply lines. These values may need to be adjusted depending on the noise present on the supply line.

Antenna Considerations

The choice of antennas is a critical and often overlooked design consideration. The range, performance and legality of an RF link are critically dependent upon the antenna. While adequate antenna performance can often be obtained by trial and error methods, antenna design and matching is a complex task. Professionally designed antennas such as those from Linx (Figure 94) help ensure maximum performance and FCC and other regulatory compliance.



Figure 94: Linx Antennas

Linx transmitter modules typically have an output power that is higher than the legal limits. This allows the designer to use an inefficient antenna such as a loop trace or helical to meet size, cost or cosmetic requirements and still achieve full legal output power for maximum range. If an efficient antenna is used, then some attenuation of the output power will likely be needed.

It is usually best to utilize a basic quarter-wave whip until your prototype product is operating satisfactorily. Other antennas can then be evaluated based on the cost, size and cosmetic requirements of the product. Additional details are in Application Note AN-00500.

Interference Considerations

The RF spectrum is crowded and the potential for conflict with unwanted sources of RF is very real. While all RF products are at risk from interference, its effects can be minimized by better understanding its characteristics.

Interference may come from internal or external sources. The first step is to eliminate interference from noise sources on the board. This means paying careful attention to layout, grounding, filtering and bypassing in order to eliminate all radiated and conducted interference paths. For many products, this is straightforward; however, products containing components such as switching power supplies, motors, crystals and other potential sources of noise must be approached with care. Comparing your own design with a Linx evaluation board can help to determine if and at what level design-specific interference is present.

External interference can manifest itself in a variety of ways. Low-level interference produces noise and hashing on the output and reduces the link's overall range.

High-level interference is caused by nearby products sharing the same frequency or from near-band high-power devices. It can even come from your own products if more than one transmitter is active in the same area. It is important to remember that only one transmitter at a time can occupy a frequency, regardless of the coding of the transmitted signal. This type of interference is less common than those mentioned previously, but in severe cases it can prevent all useful function of the affected device.

Although technically not interference, multipath is also a factor to be understood. Multipath is a term used to refer to the signal cancellation effects that occur when RF waves arrive at the receiver in different phase relationships. This effect is a particularly significant factor in interior environments where objects provide many different signal reflection paths. Multipath cancellation results in lowered signal levels at the receiver and shorter useful distances for the link.

Pad Layout

The pad layout diagrams below are designed to facilitate both hand and automated assembly. Figure 95 shows the footprint for the standard version and Figure 96 shows the footprint for the pre-certified version.

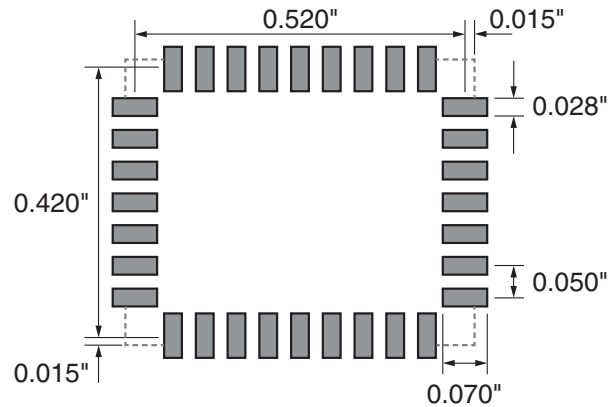

Figure 95: HUM-***-PRC Recommended PCB Layout

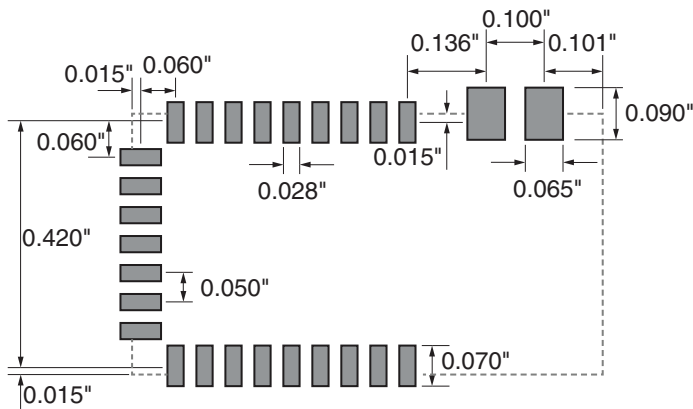

Figure 96: HUM-***-PRC-UFL/CAS Recommended PCB Layout

Microstrip Details

A transmission line is a medium whereby RF energy is transferred from one place to another with minimal loss. This is a critical factor, especially in high-frequency products like Linx RF modules, because the trace leading to the module's antenna can effectively contribute to the length of the antenna, changing its resonant bandwidth. In order to minimize loss and detuning, some form of transmission line between the antenna and the module should be used unless the antenna can be placed very close (<1/8in) to the module. One common form of transmission line is a coax cable and another is the microstrip. This term refers to a PCB trace running over a ground plane that is designed to serve as a transmission line between the module and the antenna. The width is based on the desired characteristic impedance of the line, the thickness of the PCB and the dielectric constant of the board material. For standard 0.062in thick FR-4 board material, the trace width would be 111 mils. The correct trace width can be calculated for other widths and materials using the information in Figure 97 and examples are provided in Figure 98. Software for calculating microstrip lines is also available on the Linx website.

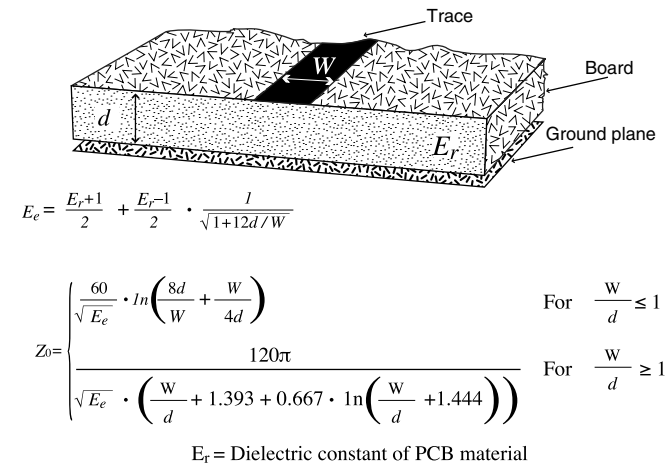

Figure 97: Microstrip Formulas

Example Microstrip Calculations

Dielectric Constant	Width / Height Ratio (W / d)	Effective Dielectric Constant	Characteristic Impedance (Ω)
4.80	1.8	3.59	50.0
4.00	2.0	3.07	51.0
2.55	3.0	2.12	48.8

Figure 98: Example Microstrip Calculations

Board Layout Guidelines

The module's design makes integration straightforward; however, it is still critical to exercise care in PCB layout. Failure to observe good layout techniques can result in a significant degradation of the module's performance. A primary layout goal is to maintain a characteristic 50-ohm impedance throughout the path from the antenna to the module. Grounding, filtering, decoupling, routing and PCB stack-up are also important considerations for any RF design. The following section provides some basic design guidelines.

During prototyping, the module should be soldered to a properly laid-out circuit board. The use of prototyping or "perf" boards results in poor performance and is strongly discouraged. Likewise, the use of sockets can have a negative impact on the performance of the module and is discouraged.

The module should, as much as reasonably possible, be isolated from other components on your PCB, especially high-frequency circuitry such as crystal oscillators, switching power supplies, and high-speed bus lines.

When possible, separate RF and digital circuits into different PCB regions.

Make sure internal wiring is routed away from the module and antenna and is secured to prevent displacement.

Do not route PCB traces directly under the module. There should not be any copper or traces under the module on the same layer as the module, just bare PCB. The underside of the module has traces and vias that could short or couple to traces on the product's circuit board.

The Pad Layout section shows a typical PCB footprint for the module. A ground plane (as large and uninterrupted as possible) should be placed on a lower layer of your PC board opposite the module. This plane is essential for creating a low impedance return for ground and consistent stripline performance.

Use care in routing the RF trace between the module and the antenna or connector. Keep the trace as short as possible. Do not pass it under the module or any other component. Do not route the antenna trace on multiple PCB layers as vias add inductance. Vias are acceptable for tying together ground layers and component grounds and should be used in multiples. The -CAS version must follow the layout in Figure 92.

Each of the module's ground pins should have short traces tying immediately to the ground plane through a via.

Bypass caps should be low ESR ceramic types and located directly adjacent to the pin they are serving.

A 50-ohm coax should be used for connection to an external antenna. A 50-ohm transmission line, such as a microstrip, stripline or coplanar waveguide should be used for routing RF on the PCB. The Microstrip Details section provides additional information.

In some instances, a designer may wish to encapsulate or "pot" the product. There are a wide variety of potting compounds with varying dielectric properties. Since such compounds can considerably impact RF performance and the ability to rework or service the product, it is the responsibility of the designer to evaluate and qualify the impact and suitability of such materials.

Helpful Application Notes from Linx

It is not the intention of this manual to address in depth many of the issues that should be considered to ensure that the modules function correctly and deliver the maximum possible performance. We recommend reading the application notes listed in Figure 99 which address in depth key areas of RF design and application of Linx products. These applications notes are available online at www.linxtechnologies.com or by contacting the Linx literature department.

Helpful Application Note Titles	
Note Number	Note Title
AN-00100	RF 101: Information for the RF Challenged
AN-00126	Considerations for Operation Within the 902–928MHz Band
AN-00130	Modulation Techniques for Low-Cost RF Data Links
AN-00140	The FCC Road: Part 15 from Concept to Approval
AN-00500	Antennas: Design, Application, Performance
AN-00501	Understanding Antenna Specifications and Operation

Figure 99: Helpful Application Note Titles

Production Guidelines

The module is housed in a hybrid SMD package that supports hand and automated assembly techniques. Since the modules contain discrete components internally, the assembly procedures are critical to ensuring the reliable function of the modules. The following procedures should be reviewed with and practiced by all assembly personnel.

Hand Assembly

Pads located on the bottom of the module are the primary mounting surface (Figure 100). Since these pads are inaccessible during mounting, castellations that run up the side of the module have been provided to facilitate solder wicking to the module's underside. This allows for very

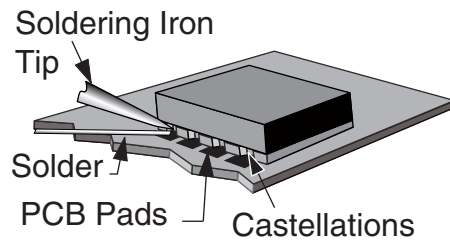

Figure 100: Soldering Technique

quick hand soldering for prototyping and small volume production. If the recommended pad guidelines have been followed, the pads will protrude slightly past the edge of the module. Use a fine soldering tip to heat the board pad and the castellation, then introduce solder to the pad at the module's edge. The solder will wick underneath the module, providing reliable attachment. Tack one module corner first and then work around the device, taking care not to exceed the times in Figure 101.

Warning: Pay attention to the absolute maximum solder times.

Absolute Maximum Solder Times

Hand Solder Temperature: +427°C for 10 seconds for lead-free alloys

Reflow Oven: +255°C max (see Figure 102)

Figure 101: Absolute Maximum Solder Times

Automated Assembly

For high-volume assembly, the modules are generally auto-placed. The modules have been designed to maintain compatibility with reflow processing techniques; however, due to their hybrid nature, certain aspects of the assembly process are far more critical than for other component types. Following are brief discussions of the three primary areas where caution must be observed.

Reflow Temperature Profile

The single most critical stage in the automated assembly process is the reflow stage. The reflow profile in Figure 102 should not be exceeded because excessive temperatures or transport times during reflow will irreparably damage the modules. Assembly personnel need to pay careful attention to the oven's profile to ensure that it meets the requirements necessary to successfully reflow all components while still remaining within the limits mandated by the modules. The figure below shows the recommended reflow oven profile for the modules.

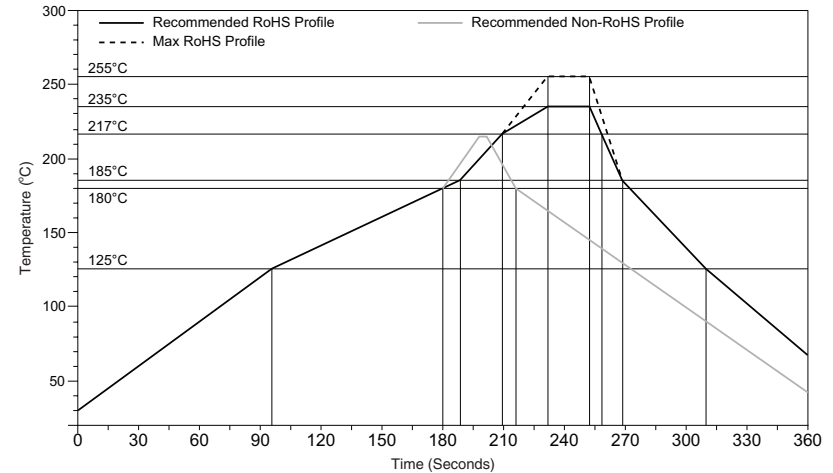

Figure 102: Maximum Reflow Temperature Profile

Shock During Reflow Transport

Since some internal module components may reflow along with the components placed on the board being assembled, it is imperative that the modules not be subjected to shock or vibration during the time solder is liquid. Should a shock be applied, some internal components could be lifted from their pads, causing the module to not function properly.

Washability

The modules are wash-resistant, but are not hermetically sealed. Linx recommends wash-free manufacturing; however, the modules can be subjected to a wash cycle provided that a drying time is allowed prior to applying electrical power to the modules. The drying time should be sufficient to allow any moisture that may have migrated into the module to evaporate, thus eliminating the potential for shorting damage during power-up or testing. If the wash contains contaminants, the performance may be adversely affected, even after drying.

General Antenna Rules

The following general rules should help in maximizing antenna performance.

1. Proximity to objects such as a user's hand, body or metal objects will cause an antenna to detune. For this reason, the antenna shaft and tip should be positioned as far away from such objects as possible.
2. Optimum performance is obtained from a $\frac{1}{4}$ - or $\frac{1}{2}$ -wave straight whip mounted at a right angle to the ground plane (Figure 103). In many cases, this isn't desirable for practical or ergonomic reasons, thus, an alternative antenna style such as a helical, loop or patch may be utilized and the corresponding sacrifice in performance accepted.

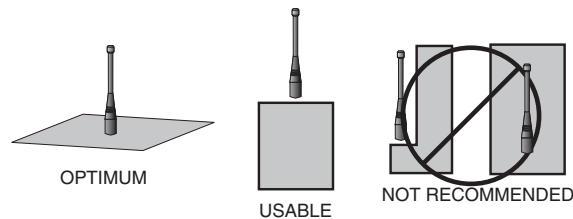

Figure 103: Ground Plane Orientation

3. If an internal antenna is to be used, keep it away from other metal components, particularly large items like transformers, batteries, PCB tracks and ground planes. In many cases, the space around the antenna is as important as the antenna itself. Objects in close proximity to the antenna can cause direct detuning, while those farther away will alter the antenna's symmetry.
4. In many antenna designs, particularly $\frac{1}{4}$ -wave whips, the ground plane acts as a counterpoise, forming, in essence, a $\frac{1}{2}$ -wave dipole (Figure 104). For this reason, adequate ground plane area is essential. The ground plane can be a metal case or ground-fill areas on a circuit board. Ideally, it should have a surface area less than or equal to the overall length of the $\frac{1}{4}$ -wave radiating element. This is often not practical due to size and configuration constraints. In these instances, a designer must make the best use of the area available to create as much ground

VERTICAL $\lambda/4$ GROUNDED ANTENNA (MARCONI)

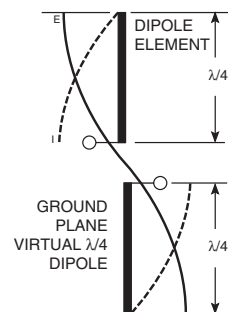

Figure 104: Dipole Antenna

plane as possible in proximity to the base of the antenna. In cases where the antenna is remotely located or the antenna is not in close proximity to a circuit board, ground plane or grounded metal case, a metal plate may be used to maximize the antenna's performance.

5. Remove the antenna as far as possible from potential interference sources. Any frequency of sufficient amplitude to enter the receiver's front end will reduce system range and can even prevent reception entirely. Switching power supplies, oscillators or even relays can also be significant sources of potential interference. The single best weapon against such problems is attention to placement and layout. Filter the module's power supply with a high-frequency bypass capacitor. Place adequate ground plane under potential sources of noise to shunt noise to ground and prevent it from coupling to the RF stage. Shield noisy board areas whenever practical.
6. In some applications, it is advantageous to place the module and antenna away from the main equipment (Figure 105). This can avoid interference problems and allows the antenna to be oriented for optimum performance. Always use 50Ω coax, like RG-174, for the remote feed.

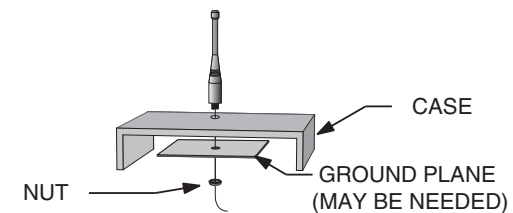

Figure 105: Remote Ground Plane

Common Antenna Styles

There are hundreds of antenna styles and variations that can be employed with Linx RF modules. Following is a brief discussion of the styles most commonly utilized. Additional antenna information can be found in Linx Application Notes AN-00100, AN-00140, AN-00500 and AN-00501. Linx antennas and connectors offer outstanding performance at a low price.

Whip Style

A whip style antenna (Figure 106) provides outstanding overall performance and stability. A low-cost whip can be easily fabricated from a wire or rod, but most designers opt for the consistent performance and cosmetic appeal of a professionally-made model. To meet this need, Linx offers a wide variety of straight and reduced height whip style antennas in permanent and connectorized mounting styles.



Figure 106: Whip Style Antennas

The wavelength of the operational frequency determines an antenna's overall length. Since a full wavelength is often quite long, a partial 1/2- or 1/4-wave antenna is normally employed. Its size and natural radiation resistance make it well matched to Linx modules. The proper length for a straight 1/4-wave can be easily determined using the formula in Figure 107. It is also possible to reduce the overall height of the antenna by using a helical winding. This reduces the antenna's bandwidth but is a great way to minimize the antenna's physical size for compact applications. This also means that the physical appearance is not always an indicator of the antenna's frequency.

$$L = \frac{234}{F_{\text{MHz}}}$$

Figure 107:
L = length in feet of quarter-wave length
F = operating frequency in megahertz

Specialty Styles

Linx offers a wide variety of specialized antenna styles (Figure 108). Many of these styles utilize helical elements to reduce the overall antenna size while maintaining reasonable performance. A helical antenna's bandwidth is often quite narrow and the antenna can detune in proximity to other objects, so care must be exercised in layout and placement.



Figure 108: Specialty Style Antennas

Loop Style

A loop or trace style antenna is normally printed directly on a product's PCB (Figure 109). This makes it the most cost-effective of antenna styles. The element can be made self-resonant or externally resonated with discrete components, but its actual layout is usually product specific. Despite the cost advantages, loop style antennas are generally inefficient and useful only for short range applications. They are also very sensitive to changes in layout and PCB dielectric, which can cause consistency issues during production. In addition, printed styles are difficult to engineer, requiring the use of expensive equipment including a network analyzer. An improperly designed loop will have a high VSWR at the desired frequency which can cause instability in the RF stage.



Figure 109: Loop or Trace Antenna

Linx offers low-cost planar (Figure 110) and chip antennas that mount directly to a product's PCB. These tiny antennas do not require testing and provide excellent performance despite their small size. They offer a preferable alternative to the often problematic "printed" antenna.



Figure 110: SP Series "Splatch" and uSP "MicroSplatch" Antennas

Regulatory Considerations

Note: Linx RF modules are designed as component devices that require external components to function. The purchaser understands that additional approvals may be required prior to the sale or operation of the device, and agrees to utilize the component in keeping with all laws governing its use in the country of operation.

When working with RF, a clear distinction must be made between what is technically possible and what is legally acceptable in the country where operation is intended. Many manufacturers have avoided incorporating RF into their products as a result of uncertainty and even fear of the approval and certification process. Here at Linx, our desire is not only to expedite the design process, but also to assist you in achieving a clear idea of what is involved in obtaining the necessary approvals to legally market a completed product.

For information about regulatory approval, read AN-00142 on the Linx website or call Linx. Linx designs products with worldwide regulatory approval in mind.

In the United States, the approval process is actually quite straightforward. The regulations governing RF devices and the enforcement of them are the responsibility of the Federal Communications Commission (FCC). The regulations are contained in Title 47 of the United States Code of Federal Regulations (CFR). Title 47 is made up of numerous volumes; however, all regulations applicable to this module are contained in Volume 0-19. It is strongly recommended that a copy be obtained from the FCC's website, the Government Printing Office in Washington or from your local government bookstore. Excerpts of applicable sections are included with Linx evaluation kits or may be obtained from the Linx Technologies website, www.linxtechnologies.com. In brief, these rules require that any device that intentionally radiates RF energy be approved, that is, tested for compliance and issued a unique identification number. This is a relatively painless process. Final compliance testing is performed by one of the many independent testing laboratories across the country. Many labs can also provide other certifications that the product may require at the same time, such as UL, CLASS A / B, etc. Once the completed product has passed, an ID number is issued that is to be clearly placed on each product manufactured.

Questions regarding interpretations of the Part 2 and Part 15 rules or the measurement procedures used to test intentional radiators such as Linx RF modules for compliance with the technical standards of Part 15 should be addressed to:

Federal Communications Commission
Equipment Authorization Division
Customer Service Branch, MS 1300F2
7435 Oakland Mills Road
Columbia, MD, US 21046
Phone: + 1 301 725 585 | Fax: + 1 301 344 2050
Email: labinfo@fcc.gov

International approvals are slightly more complex, although Linx modules are designed to allow all international standards to be met. If the end product is to be exported to other countries, contact Linx to determine the specific suitability of the module to the application.

All Linx modules are designed with the approval process in mind and thus much of the frustration that is typically experienced with a discrete design is eliminated. Approval is still dependent on many factors, such as the choice of antennas, correct use of the frequency selected and physical packaging. While some extra cost and design effort are required to address these issues, the additional usefulness and profitability added to a product by RF makes the effort more than worthwhile.