



Belden® Rack and Cabinet Systems Catalog



Our End-to-End Expertise
Your End-to-End Solution

Racks and Cabinets
Cable Management
Airflow Management
Cabinet Power Distribution Units
**Monitoring (Power, Environment,
Access)**

BELDEN



Belden — the most trusted brand for reliable signal transmission solutions — offers a complete selection of racking, cabinets, power distribution units, monitoring and airflow management products to meet your infrastructure needs and optimize system performance.

Faster.
Easier.
Better.



Belden Infrastructure Solutions

Today's data center, broadcast, AV and security professionals must ensure that their infrastructure is highly available, scalable and flexible while also controlling operating expenses. These conflicting objectives have drawn attention to the performance of physical infrastructure elements, including heating and cooling, rack-level power, bandwidth and physical security management — all of which impact infrastructure availability and, therefore, mission-critical applications.

Belden understands the issues you face daily — cooling, power, density and security — and can help you capitalize on these opportunities by implementing the right blend of technologies to maximize the efficiency of your enterprise in a manner that complements your system's performance requirements — today and into the future.

Table of Contents

Introduction	3-9	
Belden Infrastructure Solutions	3	
Application Guide for Belden Cabinets	4	
Product Summary and Selection Guide	5	
Unique Offerings From Belden	6-7	
Customized Racks and Cabinets	8	
Features and Benefits of Belden Cabinets	9	
Section 1 — Racks and Cabinets	10-47	
XHM Series — Multi-Media Cabinets	11-13	
XHS Series — Server, Networking and Switch Cabinets	14-17	
XHSN Series — Networking Cabinets	18-19	
XHM, XHS and XHSN Series Cabinets - Cable Management and Zero U Patching	20	
XHM, XHS and XHSN Accessories	21	
XHMS — Server Cabinets,		
XHSS — Networking Switch Cabinets	22-23	
Ladder-Rack-Style Cable Runways	24-25	
Open Bridge Racks	26	
Heat Containment Systems	27-32	
XHN Series — NEMA 12 Cabinets	33-34	
XHW Series — Wall-Mount Cabinets	35-37	
SecurePatch	38	
Consolidation/MDU Enclosures:		
In-Suite Distribution	39	
Zone Enclosures	40	
2- and 4-Post Distribution Rack Systems	41-45	
XWR and XWB Series — Wall-Mount Racks	46	
XSW Series — Swing Racks	47	
Section 2 — Broadcast Racks and Cabinets	48-62	
Advantages	49-51	
Comparison Chart	51	
XSF Series — Slim Frame for Mobile Broadcast/Telecom Applications	52-53	
XMF Series — Media Frame for Broadcast Applications	54-56	
XME Series — Media Cabinet for Broadcast, AV and Security Applications	57-59	
XMER Series — Media Cabinet for Broadcast, AV, Security and Head-End Applications	60-62	
Section 3 — Components and Accessories	63-68	
Cabinet Shelves	64	
Horizontal Cable Management	65	
Light Kits	66	
Filler Panels	65	
Grounding and Bonding	67	
Mounting and Adjoining Hardware	67	
Cabinet Access Systems	68	
Section 4 — Power Distribution and Climate Monitoring	69-78	
Cabinet Power Distribution Units (PDUs)	70-71	
Single-Phase Basic/Smart PDUs	72	
3-Phase Basic/Smart PDUs	73	
Single- and 3-Phase Switched PDUs	74	
PDU Accessories — Mounting, Cord Management and Cord Set	75	
PDU Configuration Guide	76	
Plug and Receptacle Configuration Chart	77	
Environmental Monitors and Sensors	78	
Section 5 — Warranty and Shipping Policy	80-81	
Belden Rack and Cabinet Manufacturing	81	
Section 6 — Part Number Index	82-83	
Customer Service and Other Belden Contacts	Back Cover	

Application Guide for Belden Cabinets



Rack or Cabinet Style	Page Number	Enterprise Networking	Data Center/Telco	Broadcast	AV	Security	Cable TV, Head End	Harsh Environment, Networking	General Purpose, Retail, Office, K-12, House of Worship, etc.
XHM	13	●	●		●	●	●		■
XHS	16	●	●						
XHSN	18	●	●						
XHMS/XHSS*	27	●	●						
Passive/Active Containment	31	■	●						
XHN**	35							●	
XHW	39	●			●	●			●
XDR	43	●	●	●					●
XWR/XWB	46	●							●
XSW	47	●							●
XSF	52			●					
XMF	54			●					
XME	57			●	●	●	●		●
XMER	60			●	●	●	●		●
PDU	69	●	●	●	●	●	●	●	●

● = Primary Application

■ = Secondary Application

* Seismic-certified cabinets.

** Production floor network equipment hosting.

Engineered to meet your specific needs.

Belden has leveraged its engineering and manufacturing expertise to bring you the most reliable cable, connectivity, cabinet and active systems solutions available — with the largest selection of products and the industry’s most trusted technical support and service.

The products featured in this catalog of Infrastructure Solutions reflect the same quality and reliability you’ve come to expect from Belden for housing and storing data, broadcast, security and other equipment. Engineered for optimal cable routing, ease of

installation and maximum convenience, Belden racks and cabinets have also been designed to match the unique requirements of various industries and applications.

This table will help you select the Belden rack and cabinet family that best suits your specific application. If you need a custom design for a special application, please call us for assistance. Our cable management teams have many years of experience in modifying and customizing cabinet designs to suit many different requirements.

Faster.
Easier.
Better.



Product Summary and Selection Guide

Infrastructure Product Family	Rack or Cabinet Style	Page Number	Application	Rack Unit	Width	Depth	Height	Equipment Mounting
Freestanding Modular Cabinets	XHM	13	Multi-Media and Server Cabinet	42, 45, 48RU	24", 30"	30", 36", 42", 48"	78.62", 83.87", 90"	19"
	XHS	16	Server, Networking and Switch Cabinets	42, 45, 48RU	30", 40"	42", 48"	78.62", 83.87", 90"	19"
	XHSN	18	Server, Networking and Switch Cabinets	42, 45, 48RU	30", 40"	42", 48"	78.62", 83.87", 90"	19"
	XHMS	27	Seismic Server Cabinet	42, 45, 48RU	24", 30"	36", 42", 48"	78.62", 83.87", 90"	19"
	XHSS	27	Seismic Switch/Networking Cabinet	42, 45, 48RU	30", 40"	42", 48"	78.62", 83.87", 90"	19"
	XHN	35	NEMA 12 Cabinet	45RU	30"	36", 42"	84"	19"
	XSF	52	Mobile Broadcast Cabinet	10-48RU	19.2"	18", 24", 30"	20.5" to 87" (14 height options)	19"
	XMF	54	Broadcast Cabinets	11-57RU	22"	24", 30", 36", 40"	22.3" to 103" (26 height options)	19"
	XME	57	Multi-Media Cabinet (fixed sides)	24-44RU	22"	20", 26.5"	48.9" to 83.9" (4 height options)	19"
	XMER	60	Multi-Media Cabinet (removable sides)	24-44RU	22"	26.5", 31.5", 36"	48.9" to 83.9" (4 height options)	19"
Wall-Mount Cabinets	XHW	39	Multi-Purpose Wall-Mount Cabinets	9, 12, 20RU	21", 23"	22.9", 27.5"	20.1", 25.3", 39.3"	19"
Distribution Racks	XDR	41	Distribution Rack – 2-Post	45RU	20.3"	15"	84"	19"
	XDRS	41	Distribution Rack – 2-Post (steel), Zone 4 Seismic Rated	44RU	24"	15"	84"	19"
	BHRR	41	Distribution Rack – 2-Post (aluminum)	45RU	20.3"	15"	84"	19"
	XDR	41	Server Rack – 4-Post	45RU	20.3"	40", 44", 48"	84"	19"
	XSW	47	Swing Rack	43RU	34.4"	15"	84"	19"
	XWR	46	Wall-Mount Rack – Swing Out	19, 26RU	19.8"	18"	36", 48"	19"
	XWR/XWB	46	Wall-Mount Rack – Hinged	2, 4, 6RU	19", 19.5"	4", 9.5"	3.5", 7", 11"	19"



Unique Offerings From Belden

End-to-End Infrastructure Solutions

Whether you're considering Belden racks and cabinets for use in a data center, broadcast studio, commercial enterprise, industrial facility or other application, it's important to look at the big picture. Chances are, you're managing a dynamic environment with evolving systems, technologies, logical architectures and business models. You need to ensure that your infrastructure is highly available, scalable and flexible while also controlling your operating expenses.

Manage Conflicting Objectives

These often-conflicting objectives focus attention on the performance of physical infrastructure elements, including heating and cooling, rack-level power, bandwidth and physical security management. The challenge is that these elements typically tend to work against each other. For example, as load is increased with high-density active equipment, the system's power and cooling requirements are increased and so are energy costs. Because these issues are directly interrelated, complications can arise from each system being manufactured, installed and supported by different vendors. That's why a systems approach for cost-effectively cooling, managing power usage and optimizing space usage is critical.

Belden Can Help

We optimize cooling, power and density opportunities because we have expertise in all three areas, offering solutions that effectively deal with all three at the rack/cabinet level.

Belden Offers:

- Airflow, power distribution and power- and climate-monitoring devices designed for high-density computing environments
- High-density racks, cabinets, copper and optical fiber cabling system components, and cable management solutions that enable maximum bandwidth and availability in an efficient footprint for better airflow and optimal use of real estate

Advantages of Belden End-to-End Infrastructure Solutions

- Greater convenience when the entire solution is from a single source
- Assurance that all components work together
- The most reliable product performance in the industry
- Dependable service and superior support
- The most trusted name in the industry with a large global sales and distribution network

Delivering **complete infrastructure solutions** to maximize efficiencies.

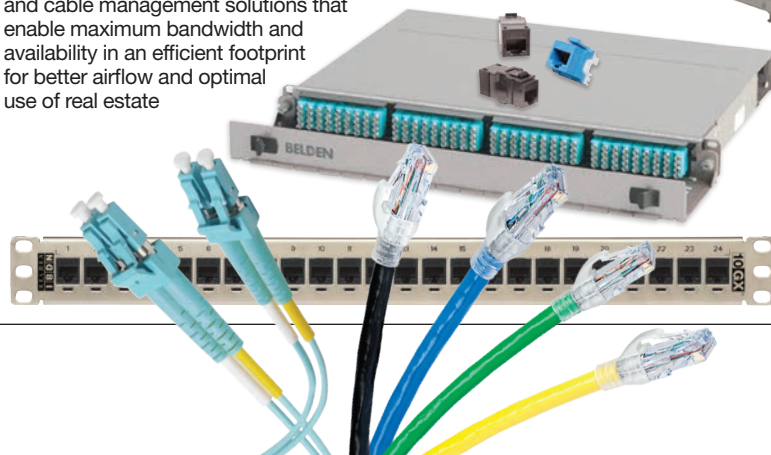

Faster.
Easier.
Better.



Unique Offerings From Belden

Data Center Ready Solutions

Data centers require adequate planning to address equipment hosting, power and thermal management. Once active equipment has been chosen, the next step is to make sure you have infrastructure to support the availability and performance your active equipment needs to deliver. Belden's dedicated engineering and manufacturing resources will design, build and deliver cabinets that support and optimize the performance of your selected active equipment. The result is a turnkey solution — from design to roll-out — on the data center floor. This service takes 100% of the

guesswork out of the design process, making it ideal for data center designers, consultants, system integrators, facility planners and managers.

Optimized Integration

- Single-source physical infrastructure solutions designed to work together to support the optimal performance of the selected active equipment
- Pre-configured equipment hosting solution with optimal mix of fiber and copper connectivity, cable managers and power distribution units (PDUs), along with airflow management for heat containment

Reduction of Deployment Time and Costs

- Pre-configured, design-validated and labeled cabinets are ready to receive servers or switches at the specific data center location (as per the assigned label)
- Best-in-class, pre-terminated fiber and copper systems, smart PDUs and active heat containment ensure fast deployment and reduced labor costs

Streamlined Logistics

- Simplified coordination of all equipment hosting-related tasks — all passive components arrive pre-installed
- Designs can be templated, saved, duplicated and modified for future use

Ease of Standardization

- Single part number ordering for a fully configured solution enables easy standardization, specification, ordering and simplified supply-chain hurdles
- Deployment control across single or multiple sites for consistency and standardization

Green Deployment

- Configured components are pre-installed to specific requirements, eliminating the need for individual packaging and reducing waste from cartons, boxes and plastics
- Consolidated shipping allows efficient packaging and a reduction in CO₂ footprints

Contact Belden Today

Belden engineers are ready to work with you to design your Data Center Ready Solution. Contact us now to start the process of delivering the optimal support environment for your active equipment.



Designing the **optimal support environment** for your active equipment.

Customized Racks and Cabinets Meet the Unique Needs of Your Installation

In-House Design, Prototyping and Manufacturing

Belden's in-house engineering and state-of-the-art sheet-metal fabrication, powder-coating and silk-screening capabilities enable rack and cabinet production from raw materials to finished goods. We can quickly develop — and deliver — technically sound, cost-competitive and compromise-free custom solutions to meet the challenges of your specific project.



Cellular-Based Manufacturing for Fast, Flexible Service

- Communicate project needs, goals and challenges directly to the Belden design team
- Customization available for quantities as low as 10 cabinets
- Quick-turnaround service — only 4–6 weeks from concept to delivery

Varying Levels of Customization

- Custom paint-color matching and silk-screened logos
- Ability to modify standard cabinet frame sizes
- Complete design/build of project-specific cabinets in steel, aluminum or stainless steel

Value-Added Services

- NEMA-style cabinets for industrial networking and outdoor networking applications
- Kitting of racks or cabinets equipped with Belden and/or other manufacturers' components enable quick and easy logistics and deployment in applications like retail POS
- Integration of power, cable management, connectivity, cooling and climate monitoring systems into cabinets
- Cabinets designed for heat containment with ducting to support high-bandwidth blade servers and switches
- Rack power distribution unit (PDU) customization for specific numbers of receptacles, single- and three-phase power, and special overlays to enhance user experience
- Chimney containment customization to accommodate varying ceiling heights with options for passive or active sensors and fan-based units



Unequaled agility to develop and deliver **compromise-free custom solutions.**



Faster.
Easier.
Better.



Features and Benefits of Belden Cabinets

Load Capacity

As data centers increase in density and bandwidth, with blade servers and high port-count switches, the need for higher-load-capacity cabinets is a growing trend. Most Belden cabinets have a welded frame construction to accommodate static loads of up to 3,000 lbs.

To accommodate flexibility in data centers during initial installation, cabinets come with casters rated to dynamic loads of up to 2,250 lbs.

Modularity

A modular cabinet design accommodates frame widths from 22" to 40", heights from 42RU to 52RU and depths from 30" to 48" — all while ensuring that cable management, power components and airflow management work seamlessly across different sizes. This modular approach enables field-upgradable changes to chimney containment systems, PDUs and cable management.



Scalability

With Zero U mounting options, fiber and copper connectivity in cabinets is scalable to address multiple-generation connectivity needs for servers and switches. Similarly, a broad portfolio of rack PDU offerings, from basic to 3-phase remote switched products, enables cabinets to support power requirements of multiple-generation active IT gear.



Adaptability

A selection of vertical and horizontal cable managers capable of handling a wide range of cable and connectivity density can be accommodated in the cabinets. The doors are field reversible with lift-off hinges.

In addition, the doors, top and bottom panels are configurable based on heat-management needs for hot-aisle/cold-aisle configuration or chimney containment.



Security and Intelligence

Cabinets can be configured with a key access or smart access system with lock control at the cabinet level or end-of-row pod level.

IP-based airflow management and environmental monitoring and alarming systems and sensors offer maximum availability.

A wide selection of smart PDUs with power monitoring and switching options offer optimized power management and PUE measurement.



Environmental and Seismic

Belden's seismic cabinets are designed to pass Zone 4 Telcordia and/or NEBS requirements in seismic zones, offering a stable working base for servers and switches. Similarly, the NEMA cabinets can accommodate factory floor or other harsh-environment equipment hosting requirements.



High-Capacity Hosting

The door is designed to provide low resistance to airflow passage and maximize the perforated surface with hexagonal 78% open perforated patterns.





SECTION ONE

Racks and Cabinets

Table of Contents	Page
Racks and Cabinets	10-47
XHM Series — Multi-Media Cabinets	11-13
XHS Series – Server, Networking and Switch Cabinets	14-17
XHSN Series - Networking Cabinets	18-19
XHM, XHS and XHSN Series Cabinets - Cable Management and Zero U Patching	20
XHM, XHS and XHSN Accessories	21
XHMS — Server Cabinets, XHSS — Networking Switch Cabinets	22-23
Ladder-Rack-Style Cable Runways	24-25
Open Bridge Racks	26
Heat Containment Systems	27-32
XHN Series — NEMA 12 Cabinets	33-34
XHW Series — Wall-Mount Cabinets	35-37
SecurePatch	38
Consolidation/MDU Enclosures: In-Suite Distribution	39
Zone Enclosures	40
2- and 4-Post Distribution Rack Systems	41-45
XWR and XWB Series — Wall-Mount Racks	46
XSW Series — Swing Racks	47



Seamlessly integrate power distribution, airflow containment and management, networking connectivity and **cable management** into one comprehensive cabinet solution — optimizing data center hosting conditions for servers and switches.

Specific Solutions for a Wide Array of Applications

As the premier supplier of cable and connectivity systems, Belden has leveraged its networking skills, engineering expertise and end-user experience to provide a broad portfolio of racks and cabinets that address security, availability and efficiency challenges.

With the X Series (XHM, XHS), Belden offers a cabinet solution that seamlessly integrates power distribution, airflow containment and management, networking connectivity and cable management to provide optimized hosting conditions for today's servers and switches. Designed to work seamlessly with Belden's market-leading fiber and copper connectivity solutions, the X Series vertical and horizontal cable management system supports high cabling/connectivity density while supporting easy moves, adds and changes.

Shipped fully assembled and configured to exact end-user requirements, the X Series modular design includes a myriad of options for doors, side panels, airflow through passive chimneys or active AEHC units and PDU mounting for easy installation and reconfiguration. Single part number ordering permits standardization and streamlined logistics.

Belden XHM (Server) and XHS (Server, Networking) cabinets reduce data center operational costs by:

- Offering a modular and scalable system that adapts to changing requirements for hosting multiple generations of IT equipment
- Enabling seamless heat-containment integration for reduced energy consumption
- Providing ganging compatibility for flexible arrangements in distributed, end-of-row or in-row switching environments
- Featuring a rigid yet light-weight door design with an integrated punched hexagonal pattern that offers an opening of 78% for superior airflow. A patent-pending hinge provides maximum security and flexibility with a dual 270-degree swing.

Faster.
Easier.
Better.



XHM Series – Multi-Media, Server Cabinets

Value-minded but versatile and feature-rich



Applications

With multiple cabinet footprints to better suit your space and application needs, the XHM Series is ideal for security, broadband, enterprise networking and data center applications. Its basic yet highly functional construction makes for a technically sound and economical cabinet system.

Design and Structural Features

- Perforated door mesh opening: 78%
- Patented dc secure door hinge: Dual 270° swing prevents aisle blocking for end-of-row cabinets
- UL 2416 Listed
- Frame construction: Welded 14 gauge
- Fixtured and robotic welded for squareness (after frame construction)
- Mounting-rails construction: 12 gauge, marked RU, RU 1 is at the bottom of the cabinet
- Static load capacity: 3,000 lbs
- Capacity on casters: 1,080 lbs on regular-capacity casters; 2,250 lbs with high-capacity casters
- EIA 310 compliant: 19" mounting standard with optional 23" mount for 30" wide cabinets
- Vertical cable management options
(See pages 20-21 for XHM Series Cabinet Accessories)
- Horizontal cable management options
(See page 65 for Accessories)
- Tool-less PDU mounting options
(See page 75)
- Heat containment options
(See pages 27-32)
- Engineered and made in the United States

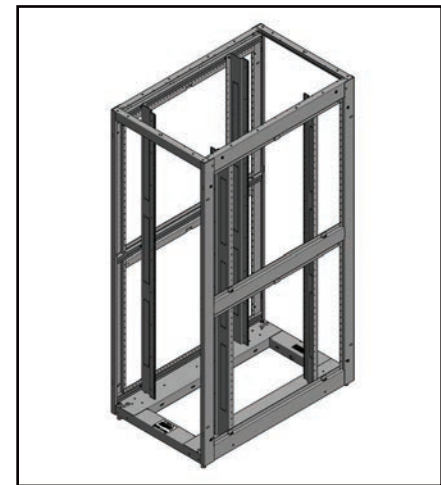
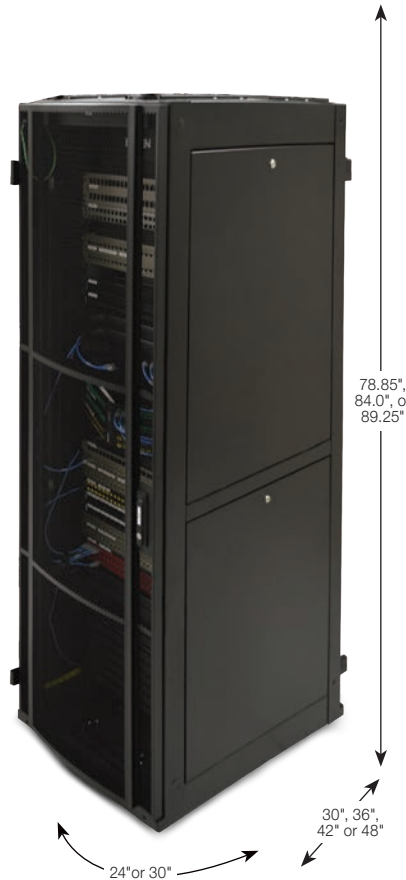

Part No. shown: XH7M451300000
(45RU x 30" W x 42" D)

24" Wide Cabinets

XHM Series Type	XH1M42	XH2M42	XH3M42	XH4M42	XH1M45	XH2M45	XH3M45	XH4M45	XH1M48	XH2M48	XH3M48	XH4M48
Dimensions: W x D x H (of Frame)	24" x 30" x 78.85"	24" x 36" x 78.85"	24" x 42" x 78.85"	24" x 48" x 78.85"	24" x 30" x 84.00"	24" x 36" x 84.00"	24" x 42" x 84.00"	24" x 48" x 84.00"	24" x 30" x 89.25"	24" x 36" x 89.25"	24" x 42" x 89.25"	24" x 48" x 89.25"
Available Mounting Rack Units (RU)	42RU				45RU				48RU			
Front Frame Opening (W x H)	21.25" x 73.85"				21.25" x 79.10"				21.25" x 84.35"			
Depth with Two Perf. Doors	33.75"	39.75"	45.75"	51.75"	33.75"	39.75"	45.75"	51.75"	33.75"	39.75"	45.75"	51.75"
Usable Depth (1)	28.75"	34.75"	40.75"	46.75"	28.75"	34.75"	40.75"	46.75"	28.75"	34.75"	40.75"	46.75"
Single Door Perforated Area	1365 sq. in.				1465 sq. in.				1565 sq. in.			

Note: (1) Standard Cabinet w/ curved perf front door & split perf rear door (2) Distance from front-most mounting rail face to inside of rear frame (3) Based on curved perf door

30" Wide Cabinets

XHM Series Type	XH5M42	XH6M42	XH7M42	XH8M42	XH5M45	XH6M45	XH7M45	XH8M45	XH5M48	XH6M48	XH7M48	XH8M48
Dimensions: W x D x H (of Frame)	30" x 30" x 78.85"	30" x 36" x 78.85"	30" x 42" x 78.85"	30" x 48" x 78.85"	30" x 30" x 84.00"	30" x 36" x 84.00"	30" x 42" x 84.00"	30" x 48" x 84.00"	30" x 30" x 89.25"	30" x 36" x 89.25"	30" x 42" x 89.25"	30" x 48" x 89.25"
Available Mounting Rack Units (RU)	42RU				45RU				48RU			
Front Frame Opening (W x H)	27.25" x 73.85"				27.25" x 79.10"				27.25" x 84.35"			
Depth with Two Perf. Doors	33.75"	39.75"	45.75"	51.75"	33.75"	39.75"	45.75"	51.75"	33.75"	39.75"	45.75"	51.75"
Usable Depth (1)	28.75"	34.75"	40.75"	46.75"	28.75"	34.75"	40.75"	46.75"	28.75"	34.75"	40.75"	46.75"
Single Door Perforated Area	1805 sq. in.				1935 sq. in.				2065 sq. in.			

Note: (1) Standard Cabinet w/ curved perf front door & split perf rear door (2) Distance from front-most mounting rail face to inside of rear frame (3) Based on curved perf door

Ordering Matrix for XHM Series

Part number example:

XH7M451311221

30"x42"x45RU black frame with casters and levelers, 12-24 tapped rails, solid top panel, perforated curved front door with lock handle, split perforated rear door with lock handle, two side panels with lock, solid bottom.

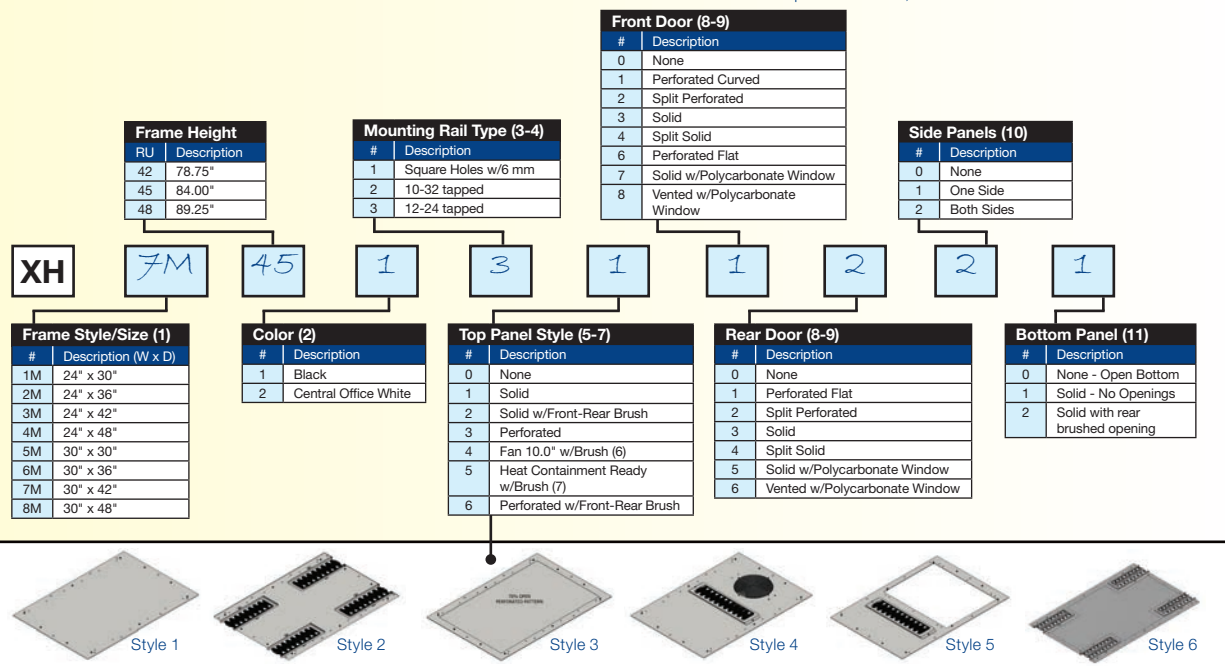

Notes:

- 1) Frame includes casters, levelers, ganging hardware, grounding studs in frame base front/rear.
- 2) Other colors and silk-screening options available for volume orders.
- 3) Includes two pairs of 19" mount EIA rails (marked RU, 1 bottom) with mounting hardware (qty = 50). 6 mm hardware standard with square rails. 30" wide cabinet uses wide EIA rails featuring three removable knock out per rails. Brush frame for knock out ordered separately. Knock out compatible with zero mounting of standard 1U patch panel.
- 4) Default front rail position 3.0" from cabinet face and 24" between rails for 30" and 36" deep, 30" between rails for 42" and 48" deep.
- 5) Custom top panel available for volume orders.
- 6) Fan top panel included, 10" dia., 550 CFM fan (120V).
- 7) Heat containment top (42" and 48" deep only) ready to accept passive or active containment chimney.
- 8) Front and rear doors include latching handle with key lock and bonding strap. Refer to Cabinet Access System Section for other access options.
- 9) Single door swings left to right and is field reversible
- 10) Side panel includes embossed key lock and bonding strap. Side panel made of a lower and upper panel. Side panels are flush, do not add width to cabinet; can be used as separator panel between cabinets.
- 11) Bottom brush panel can be rotated 180° for choice of front or rear brush entry.
- 12) Top panel Styles 3 and 6 have 78% open area hexagonal perforated pattern within the borders shown in the images above.

XHM Series – Individual Component Ordering Options

Cabinet Frame

Do not include rails, levelers and casters

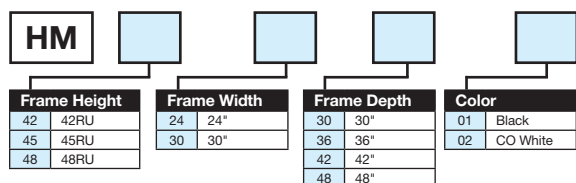

EIA Mounting Rails

Includes two pairs of rails and mounting hardware (50). Default hardware for cage nut style rails is M6. Black only. EIA 23" mount available on custom request for 30" wide cabinet.

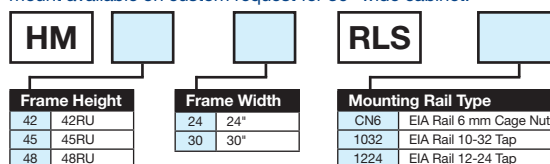

Faster.
Easier.
Better.



XHM Series – Options (continued)

Top Panel

Style 5 heat containment ready top panel only applicable to 42" and 48" deep cabinet.

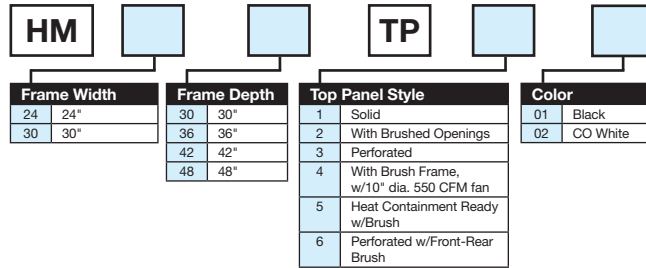

Side/Separator Panel

Side panel includes embossed key lock and bonding strap. Side panel made of a lower and upper panel. Side panels are flush, do not add width to cabinet; can be used as separator panel between cabinets.

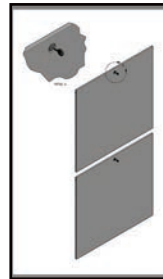
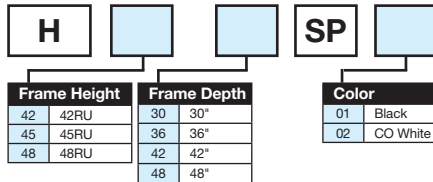

Side/Separator Panel with Lock

Door with Latch Lock Handle

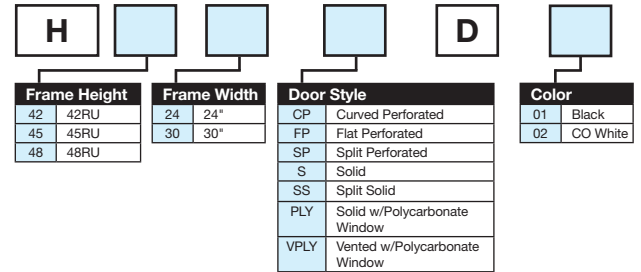

Cabinet Bottom Cover

When panel with brush is selected, will ship with brush in cabinet rear.

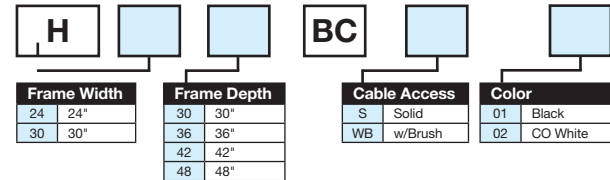

XHM Series – Accessories

Front to Rear Cable Manager

Adjustable-depth front to rear cable managers

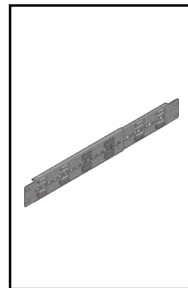
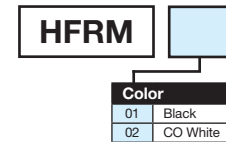

HFRM

Front Rail Air Seal Kit

To be used with passive or active containment chimneys. Rail seal kits are factory installed.

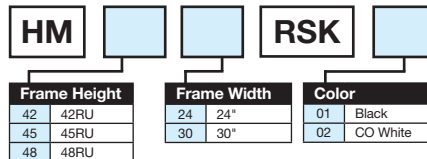

HRSBK01 (Black) or HRSBK02 (CO White) EIA rail cable pass through brush kit (1) for 30" wide XHM cabinet



Front Rail Air Seal Kit (shown in black)

Cable Manager Fingers

Cable management fingers mount to front and/or rear EIA rails.

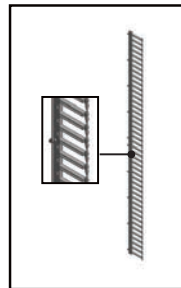
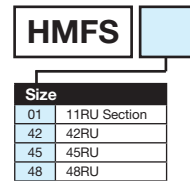

Fingers for Mounting Rails

Bottom Seal Skirt

Front and side skirt allow sealing below cabinets when on levelers.

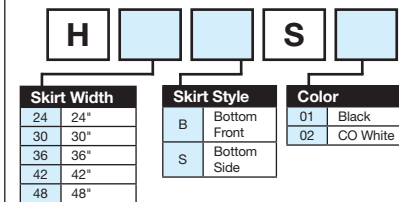

Top Cable Trough with Cover

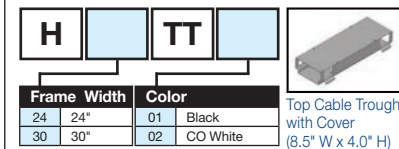



XHS Series – Server, Networking and Switch Cabinets

Supports high load capacities and proper airflow management



Part No. shown: XH1S451100000
(45RU H x 30" W x 42"D)



Part No. shown: XH2S451121110 XHS Cabinet with optional Zeru U patch panel (30"W x 48"D x 45RU), rear view.



78.85",
84.0", or
89.25"

42" or 48"

30" or 40"

Aesthetics

- Designed and manufactured in the United States, and fully customizable to meet specific equipment hosting challenges
- Available in central office white for improved internal visibility and reduced lighting needs
- 270-degree door swing means doors won't block aisles on end-of-row cabinets

Construction

- Welded 14-gauge frame and 11-gauge mounting rails support a static load of 3,000 lbs (2,250 lbs on high-capacity casters) to host a full rack of blade servers
- Cabinet frames are fixtured and robotically welded for optimal squareness
- Rail seal and adaptive containment eliminate hotspots and provide energy efficiency, monitoring and alarming
- Designed and tested for use with Belden fiber and copper networking solutions

Ease of Installation

- Modular design with options on doors, side panels, airflow management, cable management and PDU monitoring, offering easy installation and scalability
- Doors can easily be removed and oriented for left or right swing to suit application needs
- Highly integrated and shipped fully assembled with power, airflow, connectivity and cable management
- Optimal physical density and networking bandwidth for easy moves, adds and changes

Cable and Airflow Management

- XHS Series cabinets are available in 30" and 40" wide versions for optimal server and switch hosting; intake and exhaust duct options allow side-to-side gear hosting
- Integrated punched hexagonal pattern is 78% open for low-resistance airflow through doors (legacy doors available upon request)
- Front rail seals enable physical separation of supply and return air for optimized hot/cold aisle and containment deployment
- 42" and 48" deep versions easily host deep equipment chassis with rear space for power and cable management
- Available in 42, 45 and 48RU for a variety of hosting requirements

Containment and Power Distribution

- Complete lineup of IP-based power distribution units (PDUs) with available monitoring, alarming and receptacle-level switching
- Enables up to 30 kW per cabinet with Belden's innovative passive and adaptive (AEHC) chimney-based containment systems

Faster.
Easier.
Better.



XHS Series — Server Cabinets (continued)

XHS Series Specifications

- Perforated door mesh opening: 78%
- Patented hinge design: Secure, dual 270° swing
- UL 2416 Listed
- Frame construction: Welded 14 gauge
- Fixture and robotically welded for squareness
- Mounting rails construction: 11 gauge, marked RU, RU 1 is at bottom of cabinet
- Static load capacity: 3,000 lbs

- Capacity on casters: 1,080 lbs on regular capacity casters; 2,250 lbs with high-capacity casters
- EIA 310 compliant: 19" mounting
- Vertical cable management options (See pages 20-21 for X Series Cabinet Accessories)
- Horizontal cable management options (See page 65 for Accessories)

- Zero U — Vertical patch panel (See page 20-21)
- Tool-less PDU mounting options (See page 75)
- Heat containment options (See pages 27-32)
- Engineered and made in the United States

30" Wide Cabinets

XHS Series Type	XH1S	XH2S	XH1S	XH2S	XH1S	XH2S
Available Mounting Rack Units (RU)	42RU		45RU		48RU	
Dimensions: W x D x H (of frame)	30" x 42" x 78.85"	30" x 48" x 78.85"	30" x 42" x 84.00"	30" x 48" x 84.00"	30" x 42" x 89.25"	30" x 48" x 89.25"
Front Frame Opening (W x H)	27.25" x 73.85"		27.25" x 79.10"		27.25" x 84.35"	
Depth w/ two Perf. Doors (1)	45.75"	51.75"	45.75"	51.75"	45.75"	51.75"
Usable Depth (2)	40.75"	46.75"	40.75"	46.75"	40.75"	46.75"
Single Door Perf Area (3)	1805 sq. in.		1935 sq. in.		2065 sq. in.	

Note: (1) Standard Cabinet w/ curved perf front door & split perf rear door (2) Distance from front-most mounting rail face to inside of rear frame (3) Based on curved perf door

40" Wide Cabinets

XHS Series Type	XH3S	XH4S	XH3S	XH4S	XH3S	XH4S
Available Mounting Rack Units (RU)	42RU		45RU		48RU	
Dimensions: W x D x H (of frame)	40" x 42" x 78.85"	40" x 48" x 78.85"	40" x 42" x 84.00"	40" x 48" x 84.00"	40" x 42" x 89.25"	40" x 48" x 89.25"
Front Frame Opening (W x H)	37.25" x 73.85"		37.25" x 79.10"		37.25" x 84.35"	
Depth w/ two Perf. Doors (1)	45.75"	51.75"	45.75"	51.75"	45.75"	51.75"
Usable Depth (2)	40.75"	46.75"	40.75"	46.75"	40.75"	46.75"
Single Door Perf Area (3)	2652 sq. in.		2782 sq. in.		2912 sq. in.	

Note: (1) Standard Cabinet w/ curved perf front door & split perf rear door (2) Distance from front-most mounting rail face to inside of rear frame (3) Based on curved perf door

XHS Series — Configured Cabinets

Belden will configure cabinets to your exact requirements. The following are commonly requested configured cabinets. Please contact your sales representative to discuss your specific needs.

Item	Part #	Frame Size			Color	Rails	Top Panel	Doors		Side Panel	Bottom Panel	Lacing/PDU Panel	Vertical Mngr.	
		Width	Depth	Height				Front	Rear				Fingers on Rail	Box-Style Finger Mngr.
1	XH1S45-C1000	30	42	45RU	Black	Square Rails	Brush Front/Rear	Perf.	Split Perf.	1 Solid	Open	2 x 3" + 2 x 7" Rear	No	No
2	XH2S45-C1000	30	48	45RU	Black	Square Rails	Brush Front/Rear	Perf.	Split Perf.	1 Solid	Open	2 x 7" Rear	No	Rear Rails
3	XH2S45-C1001	30	48	45RU	Black	Square Rails	Brush+Chimney Ready	Perf.	Split Solid	1 Solid	w/brush	2 x 7" Rear	No	Rear Rails
4	XH1S45-C2000	30	42	45RU	CO White	Square Rails	Brush Front/Rear	Perf.	Split Perf.	1 Solid	Open	2 x 3" + 2 x 7" Rear	No	No
5	XH2S45-C2000	30	48	45RU	CO White	Square Rails	Brush Front/Rear	Perf.	Split Perf.	1 Solid	Open	2 x 7" Rear	No	Rear Rails
6	XH2S45-C2001	30	48	45RU	CO White	Square Rails	Brush+Chimney Ready	Perf.	Split Solid	1 Solid	w/brush	2 x 7" Rear	No	Rear Rails

Ordering Matrix for XHS Series

Part number example:

XH3S451311221

30" x 42" x 45RU, black frame with casters and levelers, 12-24 tapped rails, solid top, curved perforated front door with lock handle, split perforated rear door with locking handle, both side panels with locks, solid bottom.

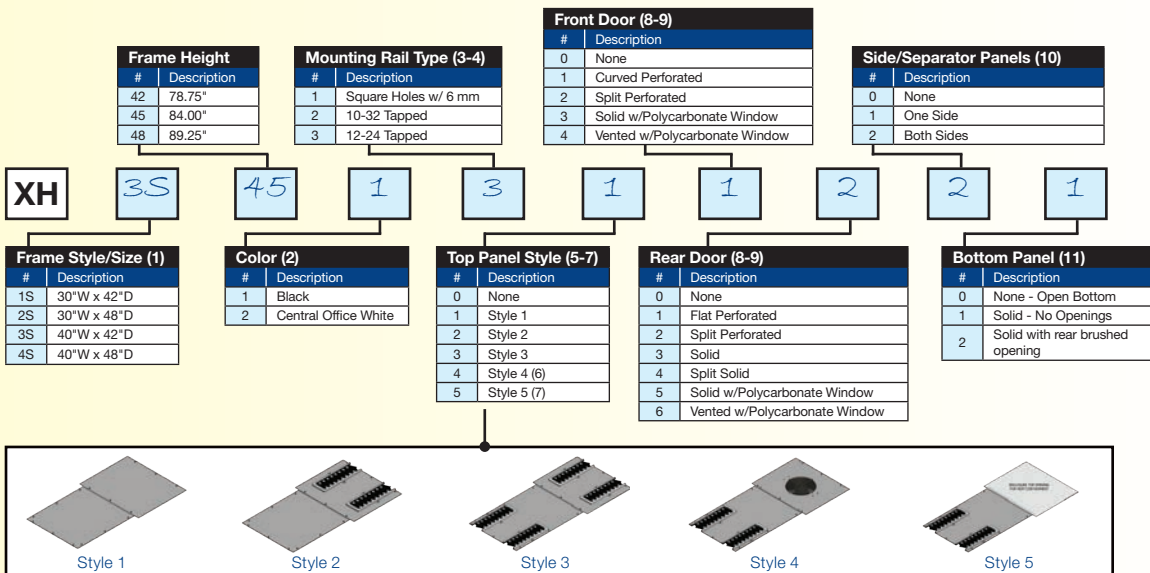

Notes:

- 1) Frame includes levelers, ganging hardware, grounding studs in frame base front and rear.
- 2) Other colors and silk-screening options available for volume orders.
- 3) Includes two pairs of 19" mount EIA rails (marked RU, 1 at bottom) with mounting hardware (qty = 50), 6 mm hardware standard with square rails.
- 4) Default front rail position 3" from cabinet face and 30" between front and rear rails.
- 5) Custom top panel available for volume orders.
- 6) Fan top panel included, 10" dia., 550 CFM fan (120V).
- 7) Style 5 top ready to accept passive or active containment chimney.
- 8) Front and rear doors include latching handle with key lock and bonding strap. Refer to Cabinet Access System Section for other access options.
- 9) Single door swings left to right and is field reversible. Refer to Cabinet Access System Section for other access options.
- 10) Side panel includes embossed key lock and bonding strap. Side panel made of a lower and upper panel. Side panels are flush, do not add width to cabinet; can be used as separator panel between cabinets.
- 11) Bottom brush panel can be rotated 180° for choice of front or rear brush entry.

XHS Series – Individual Components Ordering Options

Top Panel Sections

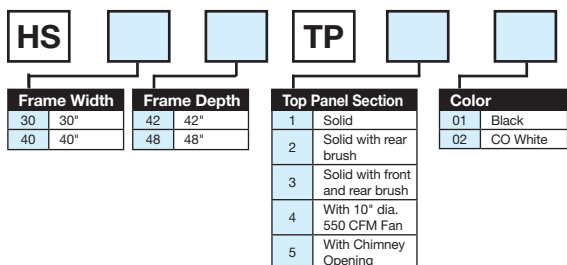

Side/Separator Panel

Side panel includes embossed key lock and bonding strap. Side panel made of a lower and upper panel. Side panels are flush, do not add width to cabinet and can be used as separator panel between cabinets.

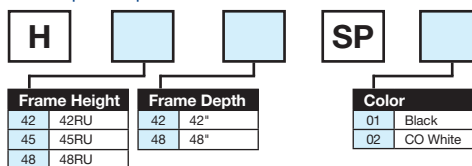

Faster.
Easier.
Better.



XHS Series – Options (continued)

EIA Mounting Rails

Includes two pairs of rails and mounting hardware (50).
Default hardware for cage nut style rails is M6.

HS				RLS	
Frame Height	Frame Width	Frame Depth	Mounting Rail Type		
42 42RU	30 30"	42 42"	CN6	EIA Rail 6 mm Cage Nut	
45 45RU	40 40"	48 48"	1032	EIA Rail 10-32 tap	
48 48RU			1224	EIA Rail 12-24 tap	

Door with Lock Latch Handle

H				D	
Frame Height	Frame Width	Door Style		Color	
42 42RU	30 30"	CP	Curved Perforated		01 Black
45 45RU	40 40"	FP	Flat Perforated		02 CO White
48 48RU		SP	Split Perforated		
		S	Solid		
		SS	Split Solid		

Cabinet Frame

Do not include rails, levelers and casters

HS				
Frame Height	Frame Width	Frame Depth	Color	
42 42RU	30 30"	42 42"	01	Black
45 45RU	40 40"	48 48"	02	CO White
48 48RU				

Cabinet Bottom Cover

When panel with brush is selected, will ship with brush in cabinet rear.

H			BC	
Frame Width	Frame Depth	Cable Access		Color
30 30"	42 42"	S	Solid	
40 40"	48 48"	WB	w/Brush	
		01	Black	
		02	CO White	

Bottom Seal Skirt

Front and side skirt allow sealing below cabinets when on levelers.

H			S	
Skirt Width	Skirt Style		Color	
30 30"	B	Bottom Front		01 Black
40 40"	S	Bottom Side		02 CO White
42 42"				
48 48"				

XHS Series – Accessories

Front Rail Air Blocker

HS			RSK	
Frame Height	Frame Width	Color		
42 42RU	30 30"	01	Black	
45 45RU	40 40"	02	CO White	
48 48RU				

Front to Rear Cable Manager

Adjustable-depth front to rear cable managers

HFRM	
Color	
01	Black
02	CO White

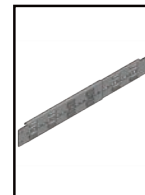

HFRM

Finger Strip Kit

Cable management fingers mount to front and/or rear EIA rails.

*For One Rail

HSFS	
Frame Height	
42	42RU
45	45RU
48	48RU



Single Finger Manager

Other Accessories

Description	Belden Part Number
Front rail air blocker cable pass through brush kit	
Brush kit (1) for 30" wide XHS rail air blocker, Black	HRSBK01
Brush kit (1) for 30" wide XHS rail air blocker, White	HRSBK02
XHS cabinet top frame brush kit	
Brush Kit (1) for front knockout top, 30" wide cabinet, Black	HSTBK30101
Brush Kit (1) for front knockout top, 30" wide cabinet, White	HSTBK30102
Brush Kit (1) for middle knockout top, 30" wide cabinet, Black	HSTBK30201
Brush Kit (1) for middle knockout top, 30" wide cabinet, White	HSTBK30202
Brush Kit (1) for rear knockout top, 30" wide cabinet, Black	HSTBK30301
Brush Kit (1) for rear knockout top, 30" wide cabinet, White	HSTBK30302
Brush Kit (1) for front or rear knockout top, 40" wide cabinet, Black	HSTBK40101
Brush Kit (1) for front or rear knockout top, 40" wide cabinet, White	HSTBK40102
Brush Kit (1) for middle knockout top, 40" wide cabinet, Black	HSTBK40201
Brush Kit (1) for middle knockout top, 40" wide cabinet, White	HSTBK40202

Top Cable Trough with Cover

H		TT	
Frame Width		Color	
30	30"	01	Black
40	40"	02	CO White

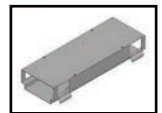

Top Cable Trough with Cover
(8.5" W x 4.0" H)



XHSN Series – Networking Cabinets

Designed to handle dense patching field while ensuring proper airflow



Aesthetics

- Designed and manufactured in the United States, and fully customizable to meet specific equipment hosting challenges
- Available in central office white for improved internal visibility and reduced lighting needs
- 270-degree door swing means doors won't block aisles on end-of-row cabinets

Construction

- Welded 14-gauge frame and 11-gauge mounting rails support a static load of 3,000 lbs (2,250 lbs on high-capacity casters) to host a full rack of blade servers
- Cabinet frames are fixtured and robotically welded for optimal squareness
- Designed and tested for use with Belden fiber and copper networking solutions

Ease of Installation

- Modular design with options on doors, side panels, airflow management, cable management and PDU monitoring, offering easy installation and scalability
- Doors can easily be removed and oriented for left or right swing to suit application needs
- Highly integrated and shipped fully assembled with power, airflow, connectivity and cable management
- Optimal physical density and networking bandwidth for easy moves, adds and changes

Cable and Airflow Management

- XHSN Series cabinets are available in 30" and 40" wide versions for optimal cabling capability
- Top design with several large cable entry knockouts allows for entry of large cable bundles into the cable management space inside the cabinet
- Cable management fingers are installed on each EIA rail to provide organized cable entry into the rack space
- Integrated punched hexagonal pattern is 78% open for low-resistance airflow through doors (legacy doors available upon request)
- Front rail seals enable physical separation of supply and return air for optimized hot/cold aisle and containment deployment
- 42" and 48" deep versions easily host deep equipment chassis with rear space for power and cable management
- Available in 42, 45 and 48RU for a variety of hosting requirements

Power Distribution

- Complete lineup of IP-based power distribution units (PDUs) with available monitoring, alarming and receptacle-level switching
- Enables up to 30 kW per cabinet with Belden's innovative passive and adaptive (AEHC) chimney-based containment systems

Faster.
Easier.
Better.



Ordering Matrix for XHSN Series

Part number example:

XH3SN451311221

30" x 42" x 45RU, black frame with casters and levelers, 12-24 tapped rails, solid top, curved perforated front door with lock handle, split perforated rear door with locking handle, both side panels with locks, solid bottom.

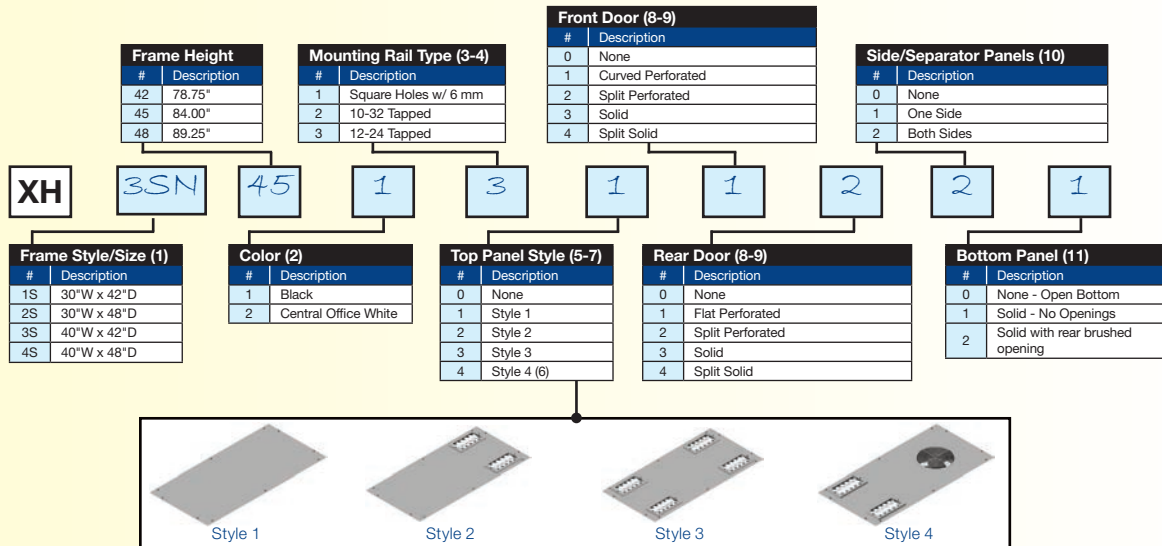

Notes:

- 1) Frame includes levelers, ganging hardware, grounding studs in frame base front and rear.
- 2) Other colors and silk-screening options available for volume orders.
- 3) Includes two pairs of 19" mount EIA rails (marked RU, 1 at bottom) with mounting hardware (qty = 50). 6 mm hardware standard with square rails.
- 4) Default front rail position 3" from cabinet face and 30" between front and rear rails.
- 5) Custom top panel available for volume orders.
- 6) Fan top panel included, 10" dia., 550 CFM fan (120V).
- 7) Style 5 top ready to accept passive or active containment chimney.
- 8) Front and rear doors include latching handle with key lock and bonding strap. Refer to Cabinet Access System Section for other access options.
- 9) Single door swings left to right and is field reversible. Refer to Cabinet Access System Section for other access options.
- 10) Side panel includes embossed key lock and bonding strap. Side panel made of a lower and upper panel. Side panels are flush, do not add width to cabinet; can be used as separator panel between cabinets.
- 11) Bottom brush panel can be rotated 180° for choice of front or rear brush entry.

XHSN Series – Individual Components Ordering Options

Top Panel Sections

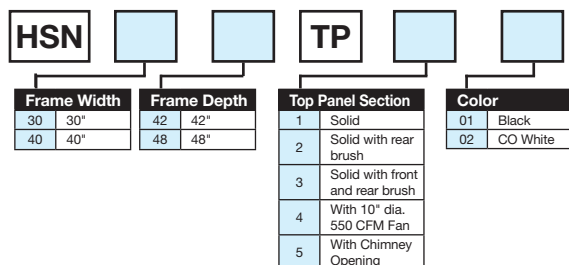

Description	Belden Part Number
XHSN cabinet top frame brush kit	
Brush Kit (1) for front or rear knockout top, 30" wide cabinet, Black	HSNTBK30101
Brush Kit (1) for front or rear knockout top, 30" wide cabinet, White	HSNTBK30102
Brush Kit (1) for middle knockout top, 30" wide cabinet, Black	HSNTBK30201
Brush Kit (1) for middle knockout top, 30" wide cabinet, White	HSNTBK30202
Brush Kit (1) for front or rear knockout top, 40" wide cabinet, Black	HSNTBK40101
Brush Kit (1) for front or rear knockout top, 40" wide cabinet, White	HSNTBK40102
Brush Kit (1) for middle knockout top, 40" wide cabinet, Black	HSNTBK40201
Brush Kit (1) for middle knockout top, 40" wide cabinet, White	HSNTBK40202

For additional individual components see the standard XHS cabinet accessories section



Lacing Panel (close-up)



Vertical Lacing/PDU Mounting Panel 3.5" and 7" wide

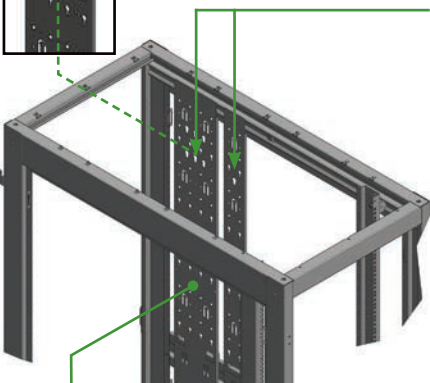

Lacing Panel shown in cabinet

Finger Style Vertical Manager

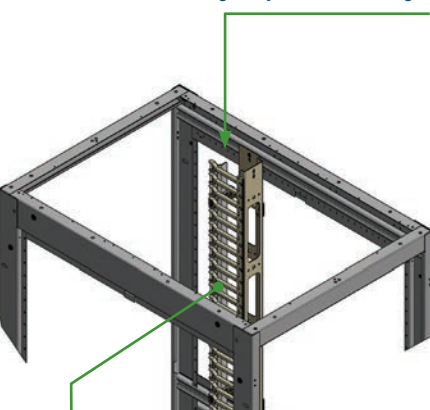

Vertical Manager shown in cabinet

XHM, XHS and XHSN Series Cabinets – Cable Management and Zero U Patching

Belden's XHM, XHS and XHSN Series cabinets and cable management components were specifically designed for integration with the Belden IBDN copper and fiber networking system for a true end-to-end solution.

The combination of Belden's extensive cable and connectivity design knowledge and years of interaction with installers and system designers allows us to offer:

Features

- A broad selection of modular vertical and horizontal cable managers in configurations that meet your exact requirements for compromise-free hosting
- Flexibility to meet customer needs requiring low to extremely high networking/hosting density
- Modular cable management components and cabinets that protect your investment because they can be reconfigured to meet evolving hosting requirements (typical cabinet system will play host to three to five generations of active equipment)
- Vertical managers that enable easy moves, adds and changes, making management of your network fast and precise while still allowing you to maintain an organized, consistent look
- A cable management system designed to maintain proper cable bend radius and minimal tension through the use of support fingers, an attachment point for cable bundles and a slack management spool ensure maximum bandwidth from your copper and fiber networks

See page 65 for Horizontal Cable Management options.

Vertical Lacing/PDU Mounting Panel*

- Manager panel 7" and 3.5" wide
- Mounts on rail struts for depth adjustability
- Panels can be mounted side by side to create manager surface
- Tool-less PDU mounting
- Lacing of cable bundles
- Attachment of ring managers
- Attachment of slack management spools
- Attachment of quick-mount base

*Lacing-PDU mounting panels (pages RC-13 and 67) are not included with cabinets or PDUs and need to be ordered separately. PDUs/panels uses tool-less "button"-style mounting.

Finger Style Vertical Managers

- Mounts on rail struts for depth adjustability
- Compatible with 30" wide cabinets
- Can be used in cabinet front and rear
- Includes doors to hide cables and provide an organized look
- Vertical manager can be oriented two different ways to optimize cable routing

Finger Style Features:

- 4" wide x 6" deep for 24 sq. in. of cross-sectional area
- For medium- and high-density applications
- Management fingers align with mounting rail RU
- Finger allows for cable support and bend radius control
- Oblong opening allows cable routing into the manager

Faster.
Easier.
Better.



XHM, XHS and XHSN Series – Accessories



Vertical Lacing/PDU Mounting Panel

HVMP			
Panel Width	Frame Height	Color	
01 3.5"	42 42RU	01	Black
02 7"	45 45RU	02	CO White
	48 48RU		

Vertical Manager – Finger Style

With door.

HVM	02		
Frame Height	Color		
42 42RU	01	Black	
45 45RU	02	CO White	
48 48RU			

Other Accessories

Description	Belden Part Number
Ring Kits	
Cable Management Ring Plastic (Qty = 5) 3" x 1.5" Reversible	XMR01
Cable Management Ring Kit (Qty = 5) 6.5" Wide x 3" Deep	XMR02
Cable Management Ring Kit (Qty = 5) 2.5" Wide x 3" Deep	XMR03
Fiber Slack Management Spools 6" deep (includes 2 spools)	BHSP020
Fiber Slack Management Spools 2" deep for lacing panels (includes 2 spools)	BHSP030
Quick Mount Base (Qty = 10) includes Fastener, for 1/4" Holes	XTCM01
Velcro Cable Ties, 25 per Roll, 8"L	AX100783
Velcro Cable Ties, 25 per Roll, 12"L	AX100784
Vertical Ground Bars	
Vertical Ground Bar, Isolated, 42RU	HVGB0142
Vertical Ground Bar, Isolated, 45RU	HVGB0145
Vertical Ground Bar, Isolated, 48RU	HVGB0148
Miscellaneous	
Casters Kit (4), regular-capacity 1,080 lbs	XCK01
Casters Kit (4), high-capacity 2,250 lbs	XCK02
Levelers Kit (4)	XLK01
Bolt-together kit for cabinets	XBK01

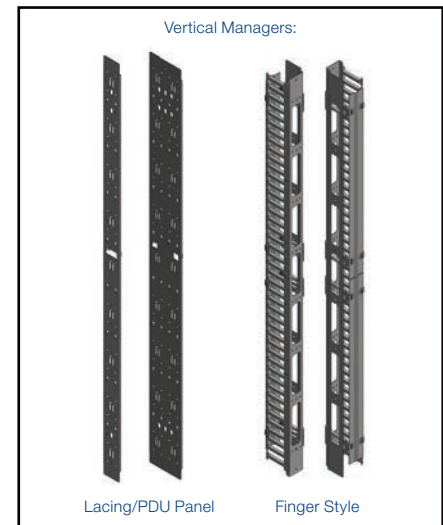

Zero U – Vertical Patch Panel and Connectivity

Features

- Attach to mounting rails
- Vertical patch panels are compatible with Belden copper and fiber connectivity (FX UHD, FX Ultra Frames and Cassettes)

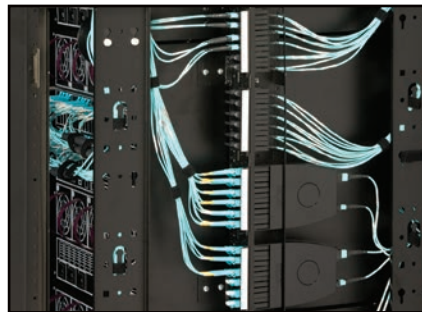

Belden Zero U Vertical patch panel allows for optimal use of mounting space into XHS Series cabinets by providing high-density connectivity options along equipment mounting rails.

Description	Belden Part Number
Zero U – Vertical Patch Panel and Connectivity	
Vertical Patch Panel (7 positions), Compatible with XHS Cabinets	XZUK01
Vertical Patch Panel (14 positions), Compatible with XHS Cabinets	XZUK02
FXUHD KeyConnect Frame Blank	FFZH00BB
FXUHD KeyConnect Frame 6-Port, Black (Empty)	FFZH06KC
FXUHD KeyConnect Frame 8-Port, Black (Empty)	FFZH08KC
10GX KeyConnect Couplers for Vertical Mount Patch Panel, 8-Port, Black	AX105366
CAT6+ KeyConnect Couplers for Vertical Mount Patch Panel, 8-Port, Black	AX105367



XHMS - Server Cabinets, XHSS - Networking Switch Cabinets

Certified to Seismic Zone 4 for mission-critical data centers

Applications

Belden's seismic cabinets feature robust steel frames for hosting servers, switches and network components in earthquake zones. Certified to Seismic Zone 4 requirements, these cabinets have passed vibration and shock testing per GR-063-CORE Network Equipment Building System (NEBS) requirements with no structural damage in a certified lab.

Design and Structural Features

- Welded steel frame construction reinforced with a heavy-gauge steel sub-frame for extra rigidity
- Highly perforated doors with stiffener channels ensure sturdiness while reducing risk of equipment damage during seismic events
- Adjustable EIA mounting rails support a 2,000 lb static load under normal operating conditions
- Finger-style vertical managers with brushed cable pass throughs enable front-to-rear routing while maintaining supply-return air sealing properties
- Compatible with passive and active chimney-based containment solutions
- Pre-configured switch cabinets with cable management, air baffles, intake and exhaust duct (for side-to-side venting) and power distribution units (PDUs) to host Cisco Catalyst 6000 and Nexus 7000 Series switches
- Offered in standard colors of black and central office white
- Integral anchoring floor mount locations*

*Belden recommends the use of a qualified contractor for the installation of seismic cabinets as per the local, state and federal building code requirements.



XHMS and XHSS Series Specifications

- Perforated door mesh opening: 78%
- Frame construction: 14-, 12- and 11-gauge welded steel
- Mounting rail construction: 12-gauge, marked RU, RU 1 is at bottom of cabinet
- Static load capacity: 2,000 lbs
- Static load capacity (seismic): 1,000 lbs
- Seismic certification: Zone 4 NEBS GR-063-CORE
- EIA 310 compliant: 19" mount equipment
- Horizontal cable management options (See page 65 for Accessories)
- Heat containment options (See pages 27-32)

Faster.
Easier.
Better.



Racks and Cabinets

Ordering Matrix for Seismic Server Cabinets (XHMS)

Part number example:

XH7MS451211222

XHMS Cabinet 30"Wx42"D frame, 45RU, Black, 10-32 tapped rails, Solid top panel, Perforated (78% open area) front door, Split perforated (78% open area) rear door, 2 side panels, Bottom panel with brush opening.

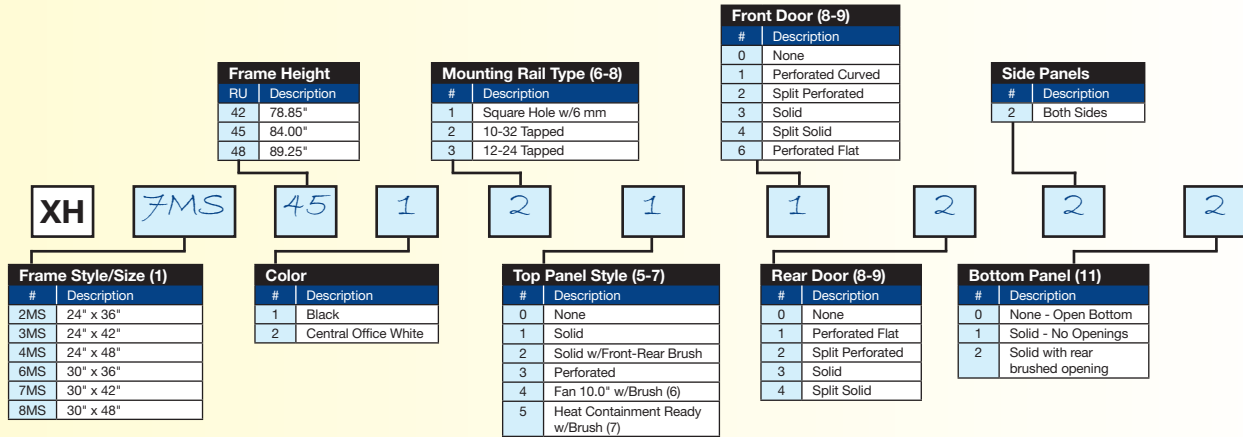

Notes:

- Cabinet dimension (measured without doors).
- Cabinet construction: Welded steel, ganging hardware, grounding studs in frame base front and rear.
- Cabinet static load capacity is 2,000 lbs, Cabinet seismic load capacity is 1,000 lbs; BELLCORE GR-63-CORE, Section 5.4.1 Certification.
- Custom top panel available on request for volume orders.
- 11 AWG mounting rails provide standard 19" rack spacing to EIA-310-D requirements.
- Equipment mounting hardware (50) included with rails (4).
- Each EIA Rail has numeral marking for each rack unit (starting at unit 1 at bottom).
- Doors are Surface-Mounted, reversible and provisioned with "swing handle" hardware, allowing changing of locksets.

Ordering Matrix for Seismic Networking-Switch Cabinets (XHSS)

Part number example:

XH3SS451311222

XHSS Cabinet 40"Wx42"D Frame, 45RU, Black, 12-24 tapped rails, Solid top panel, Perforated (78% open area) front door, Split perforated (78% open area) rear door, 2 side panels, Bottom panel with brush opening.

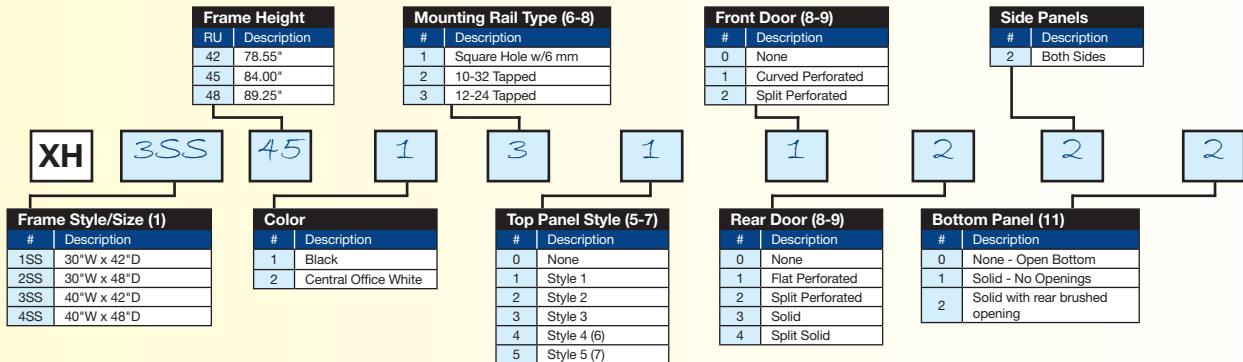

Notes:

- Cabinet dimension (measured without doors).
- Cabinet construction: Welded steel, ganging hardware, grounding studs in frame base front and rear.
- Cabinet static load capacity is 2,000 lbs, cabinet seismic load capacity is 1,000 lbs; BELLCORE GR-63-CORE, Section 5.4.1 Certification.
- Custom top panel available on request for volume orders.
- Cabinet frame is provided with six top brush openings for networking and power cable entry.
- 11 AWG mounting rails provide standard 19" rack spacing to EIA-310-D requirements.
- Equipment mounting hardware (50) included with rails (4).
- Each EIA Rail has numeral marking for each rack unit (starting at unit 1 at bottom).
- Doors are Surface-Mounted, reversible and provisioned with "swing handle" hardware, allowing changing of locksets.

Ladder-Rack-Style Cable Runways

Speed up deployment time and maximize space with our runway systems, which are designed to optimize cable bandwidth and support maximum cabling density.

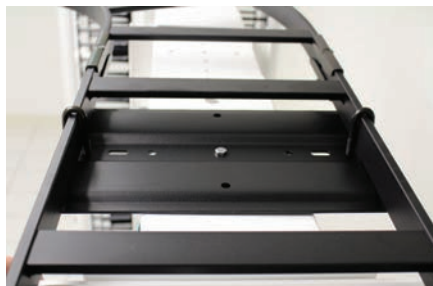
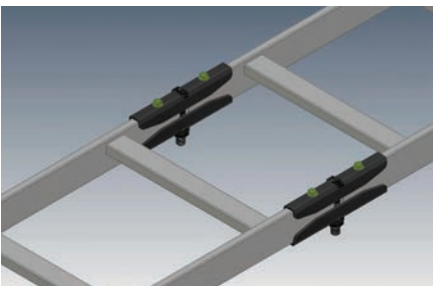

Design and Structural Features

- Complete line of ladder-rack-style runways and accessories
- Perfect complement to Belden cables for end-to-end solutions
- Belden runways and accessories have direct match/cross to most competitor brands and use the same installation practices
- Fully compatible with most ladder rack brands
- Belden runways are available from stock with a 5- to 8-day lead time for black. Extended lead times for white (6-8 weeks ARO)
- Competitively priced
- Patent-pending quick-bond Splice Kit systems allow sections of runway to be electrically bonded without a bonding strap

Ladder Runway Types/Dimensions

- Universal, TELCO and UL-style runways
- 12", 18" and 24" wide selections
- Overall length = 10' (individually boxed)
- Side stringer = 1.5" x 0.375" x 0.065"
- Cross member = 1.5" x 0.375" x 0.065" welded

Accessories

- Butt splice - patent pending
- Junction splice - patent pending
- Corner bracket
- Retaining post
- Wall to rack kit
- Radius bend
- E-Bend
- J-bolts

Faster.
Easier.
Better.



Ladder-Rack-Style Cable Runways (continued)

Universal-Style Cable Runways

Description	Belden Part Number
12" Universal Cable Runway - Black	BLRS250-12B
18" Universal Cable Runway - Black	BLRS250-18B
24" Universal Cable Runway - Black	BLRS250-24B
12" Universal Cable Runway - White	BLRS250-12W
18" Universal Cable Runway - White	BLRS250-18W
24" Universal Cable Runway - White	BLRS250-24W
Universal-Style Cable Runway	BLRS250-XXY

XX = 12, 18, 24"; Y = B (Black), W (White) - Extended lead times for white (6-8 weeks ARO)

Cable Runway - E-Bend - UL Classified

Description	Belden Part Number
12" Cable Runway E-Bend UL Classified - Black	BLEB822-12B
18" Cable Runway E-Bend UL Classified - Black	BLEB822-18B
24" Cable Runway E-Bend UL Classified - Black	BLEB822-24B
12" Cable Runway E-Bend UL Classified - White	BLEB822-12W
18" Cable Runway E-Bend UL Classified - White	BLEB822-18W
24" Cable Runway E-Bend UL Classified - White	BLEB822-24W

Extended lead times for white (6-8 weeks ARO)

Cable Runway Corner Bracket

Description	Belden Part Number
Cable Runway Corner Bracket - Black	BLCSB959-15B
Cable Runway Corner Bracket - Black	BLCSB959-24B
Cable Runway Corner Bracket - White	BLCSB959-15W
Cable Runway Corner Bracket - White	BLCSB959-24W

Extended lead times for white (6-8 weeks ARO)

3" Channel Rack-to-Runway Mounting Plate

Description	Belden Part Number
3" Channel Rack-to-Runway Mounting Plate - 9-12" Width	BLRTR595-9B
3" Channel Rack-to-Runway Mounting Plate - 15-18" Width	BLRTR595-15B
3" Channel Rack-to-Runway Mounting Plate - 24-27" Width	BLRTR595-24B

Triangular Support Bracket Kit, Aluminum

Description	Belden Part Number
12" Triangular Support Bracket Kit, Aluminum	BLTSB312-12B
18" Triangular Support Bracket Kit, Aluminum	BLTSB312-18B

Triangular Support Bracket, Steel

Description	Belden Part Number
12" Triangular Support Bracket, Steel	BLTSB746-12B
18" Triangular Support Bracket, Steel	BLTSB746-18B

Wall Angle Support Kit, Cable Runway

Description	Belden Part Number
12" Wall Angle Support Kit, Cable Runway	BLWAS421-12B
18" Wall Angle Support Kit, Cable Runway	BLWAS421-18B
24" Wall Angle Support Kit, Cable Runway	BLWAS421-24B

Cable Runway Radius Drop - Cross Member & Stringer

Description	Belden Part Number
Cable Runway Radius Drop - Cross Member - 12" Runway	BLRRD100-12B
Cable Runway Radius Drop - Cross Member - 18" Runway	BLRRD100-18B
Cable Runway Radius Drop - Stringer - TELCO Style Runway	BLRRD101-12B

TELCO-Style Cable Runways

Description	Belden Part Number
12" TELCO Cable Runway - Black	BLRT252-12B
18" TELCO Cable Runway - Black	BLRT252-18B
24" TELCO Cable Runway - Black	BLRT252-24B
12" TELCO Cable Runway - White	BLRT252-12W
18" TELCO Cable Runway - White	BLRT252-18W
24" TELCO Cable Runway - White	BLRT252-24W
TELCO-Style Cable Runway	BLRT252-XXY

XX = 12, 18, 24"; Y = B (Black), W (White) - Extended lead times for white (6-8 weeks ARO)

Radius Bend

Description	Belden Part Number
12" 90° Radius Bend - Black	BLOR723-12B
18" 90° Radius Bend - Black	BLOR723-18B
24" 90° Radius Bend - Black	BLOR723-24B
12" 90° Radius Bend - White	BLOR723-12W
18" 90° Radius Bend - White	BLOR723-18W
24" 90° Radius Bend - White	BLOR723-24W

Extended lead times for white (6-8 weeks ARO)

Splice Kits (Patent Pending)

Description	Belden Part Number
UL Classified Butt-Splice Kit - Black	BLBSU301-15B
UL Classified Junction-Splice Kit - Black	BLJSU302-15B
UL Classified Butt-Swivel Splice Kit - Black	BLBSS487-00B
UL Classified Junction Splice Kit - Black	BLBSS488-00B
UL Classified Vertical-Swivel Splice Kit - Black	BLVBS489-00B

Cable Runway End Cap

Description	Belden Part Number
Cable Runway End Cap	BLPEC642-002

Cable Runway Elevation Kit

Description	Belden Part Number
Cable Runway Rack Elevation Kit - 2", 2.5", 3" Elevation - Black	BLREK506-02B
Cable Runway Rack Elevation Kit - 4", 5", 6" Elevation - Black	BLREK506-04B
Cable Runway Rack Elevation Kit - 10", 11", 12" Elevation - Black	BLREK506-06B
Cable Runway Cabinet Elevation Kit - 2", 2.5", 3" Elevation - Black	BLREK506-12B
Cable Runway Cabinet Elevation Kit - 4", 5", 6" Elevation - Black	BLREK506-16B
Cable Runway Cabinet Elevation Kit - 10", 11", 12" Elevation - Black	BLREK506-18B

Runway Center Support Kit

Description	Belden Part Number
Center Support Kit, Cable Runway, 12"	BLCSK362-12B
Center Support Kit, Cable Runway, 18"	BLCSK362-18B
Center Support Kit, Cable Runway, 24"	BLCSK362-24B

Cable Runway Foot Kit

Description	Belden Part Number
Cable Runway Foot Kit	BLFK309-01B

Retaining Post for Cable

Description	Belden Part Number
Cable Retaining Post, 6", Single Black	BLCRP596-06B
Cable Retaining Post, 6", Qty = 50 Black	BLCRP596-56B



Open Bridge Racks

The Open Compute Project (OCP) initiative aims to create the most energy-efficient data center – one that is able to handle and manage the upcoming spike of people and data - while controlling costs and energy consumption. The ultimate goal of the Open Compute Project: Maximizing operational efficiency.

Because today's standards don't always fit upcoming needs, engineers had to rethink infrastructure to achieve their efficiency goals, and then shared their designs with the public.

Benefits/Features for the End-User

A solution you can count on

- The Belden Open Bridge Rack (OBR) can be field converted between EIA (19" mount) and OCP (21" mount) mounting standards for increased flexibility.
- Belden OBR is 28"W x 48"D and available in 40OU/44RU or 44OU/48RU.
- Migration from IEA to OCP gears is possible without having to purchase new cabinets, thanks to a reversible 44OU/48RU rail kit.
- A modular approach allows cable management configuration specific to application requirements.
- Doors feature 78% opened integrated hexagonal mesh for low air resistance and optimal cooling of hosted gears.

Contractor-friendly solution helps achieve on-time installation

- The OBR rack ships fully assembled to exact requirements.
- Cabinets can be labelled with location-specific tagging on cabinets or racks to facilitate delivery on the data center floor.
- Cabinets come with casters rated to handle dynamic loads of up to 2,250 lbs and static loads of up to 3,000 lbs.
- Rack unit (RU) and Open unit (OU) identifiers are printed on mounting rails for quick identification.
- An open bottom offers easy cable access.
- Tool-less PDU mounting supports faster deployment (in EIA configuration).

Benefits/Features for the Architect/Consultant

Meets and exceeds standards

- Belden OBR rack meets TIA/EIA 310-D and OCP equipment mounting standards.
- Allows for greater data center design flexibility by enabling mixed use of EIA and OCP gears in the same computing space.
- All materials are RoHS compliant.



Open Bridge Racks

Description	Belden Part Number
Server Rack 44RU/400U	XFI44U2848-S002
Networking Rack 44RU/400U	XFI44U2848-S003
Open Bridge Rack 44RU/400U	XFI44U2848-S004
Server Rack 48RU/440U	XFI48U2848-S005
Network Rack 48RU/440U	XFI48U2848-S006
Open Bridge Rack 48RU/440U	XFI48U2848-S007

OBR in Server and Networking configuration are shipped in EIA configuration.

For more information about the Open Compute Project, visit www.opencompute.org

Faster.
Easier.
Better.



Heat Containment Systems

Aisle and Cabinet Containment Systems

Containment Overview

A major challenge faced by data center managers today is ensuring that cooling systems do not fail and continue to provide uninterrupted cool air to equipment, especially in high-density data center environments with advanced virtualized equipment that can reach exhaust air temperatures in excess of 125° F. Most data centers that use a standard cold-hot-aisle approach are oversupplied with cold air at a ratio of 2 to 2.5 (volume of cold air supplied to volume consumed by computing equipment). With cooling representing 30-40% of total operational costs for a typical data center, containment solutions present a strong ROI potential. A standard cold/hot aisle approach can also lead to hotspots that cause equipment overheating and failures, further resulting in higher operating costs.

Containment is an industry-proven method of eliminating cold air bypass and the mixing of hot and cold air that allows for optimal use of available cooling capacity for lower operating costs. With containment, hot exhaust air from equipment is directed to CRAC units either through aisle containment systems for groups of cabinets or through active or passive chimneys at the cabinet level. This increases the differential between the inlet and outlet temperatures of CRAC units, significantly improving overall cooling system efficiency and eliminating the need to oversupply cold air. Creating separation between the hot return air and cold supply air also allows for potentially raising the supply air temperature while maintaining stable intake temperature for networking equipment, providing a more efficient, reliable and hotspot-free computing space. The containment approach easily handles the high-temperature exhaust air from advanced data processing equipment, allowing data centers to host more equipment while lowering energy consumption and total operating costs.

Belden's complete line of containment options range from the cabinet to the cold/hot aisle, offering customers the greatest flexibility for upgrading, designing and implementing a tailored solution that fits their specific data center needs in brownfield and greenfield applications. Based on computing load, cabinet layout and computing space specifications, Belden engineers can recommend and design containment solutions that will optimize availability, efficiency and hosting capacity.



- Eliminates bypass air and air recirculation
 - Reduces or eliminates cold air oversupply (2.5 to <1.2)
 - Maximizes hosting density for up to 30 kW per cabinet without precision cooling
 - Increases supply air temperature (better use of economizer loop, 8–10°)
 - Increases return-air temperature for better CRAC efficiency
- Reduces cooling costs by 30–50% over traditional hot-cold-aisle deployment
- Creates a high level of separation between supply and return air
- Eliminates hotspots for increased IT equipment availability



Aisle Containment

Belden's aisle containment solutions eliminate the mixing of hot and cold air in data center environments to maximize energy efficiency and lower operating costs. Our aisle containment systems are vendor agnostic, featuring innovative, transparent panels that are lightweight and easily attached horizontally or vertically to data center cabinets using a universal rail system. The panels are field modifiable to meet varying height and space requirements between rows of cabinets, and from the top of the cabinets to the ceiling. The aisle containment systems can also interact with smoke or fire alarm systems to ensure proper operation of critical fire suppression and safety systems.

Solutions offered are for hot-and cold-aisle containment system.

Vertical Containment

Vertical panels direct hot return air to overhead return plenum, eliminating mixing and improving overall operating efficiency of perimeter CRAC units. Using a fully ducted cold-air delivery system with vertical panels also allows cold air to be placed directly into the cold aisle, eliminating the need to use underfloor space for supply air.

Horizontal Containment

For raised-floor environments with overhead obstructions or no ceiling plenum, non-ducted panels form a roof to trap cold air, enabling higher supply temperatures and maximizing available cooling. This design can also be used for data centers utilizing in-row cooling solutions.

Aisle Doors

Belden offers swinging and sliding door options for the end of the row.

Heat Containment Systems (continued) Hot- and Cold-Aisle Containment Systems



Faster.
Easier.
Better.



Heat Containment Systems (continued) Hot- and Cold-Aisle Containment Systems

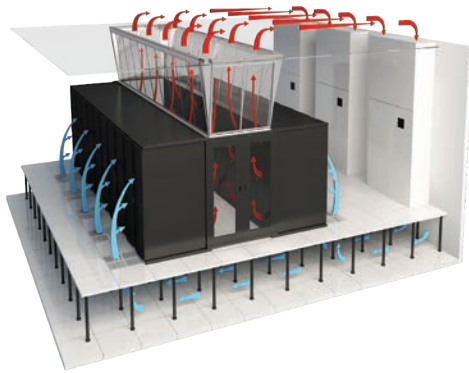

Hot-Aisle Vertical Design

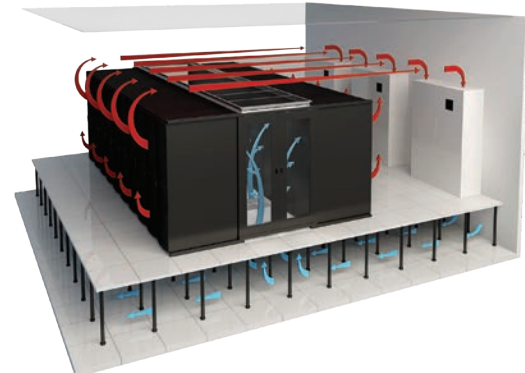

Cold-Aisle Horizontal Design

Vertical-Style Heat Containment

- Fixed Letter Series 1. Enter Cabinet Series Fixed Letters 2. Enter Hot or Cold Aisle Containment 3. Enter Containment Panel Orientation 4. Enter Floor to Ceiling Height Inches 5. Enter Cabinet Row Length Inches 6. Enter Aisle Width Inches 7. Enter Door Type with Color Option

X

HS

AC

1

2

120

240

1

1

Cabinet Series End ^{1,9}	
#	Description
Z	Custom
HS	HS-Series
HM	HM-Series

Hot Air/Cold Air ²	
#	Description
1	Hot Aisle
2	Cold Aisle

Panel Orientation ³	
#	Description
1	Vertical Hinged Black
2	Vertical Hinged White
3	Vertical Fixed Black
4	Vertical Fixed White
5	Horizontal Black
6	Horizontal White

Vertical Panel ⁴	
#	Description
###	Floor to Ceiling Height
###	If Horizontal (0)

Aisle Length ⁵	
#	Description
1	48
2	54
3	60
4	66
5	72

Aisle Width ⁶	
#	Description
1	48
2	54
3	60
4	66
5	72

Door Options ⁷	
#	Description
1	(2) Sliding Door Black
2	(2) Sliding Door White
3	(2) Swing Door Black
4	(2) Swing Door White

Notes

- Enter cabinet series. For custom cabinets contact customer service.
- Enter Hot or Cold Aisle containment.
- Enter containment panel type.
- Enter floor to ceiling height in inches.
- Enter row length in inches.
- Enter aisle width in inches. For custom contact customer service.
- Enter door type, sliding or swing.
- Custom colors available on request.
- There may have to be modifications to customer cabinets at location.

Series		Height			Width	
		floor	levelers max	caster min		
HS-SERIES	48U	89.25	91.17	90.66	30	40
HS-SERIES	45U	84	85.92	85.41	30	40
HS-SERIES	42U	78.75	80.67	80.16	30	40
HM-SERIES	48U	89.25	91.17	90.66	24	30
HM-SERIES	45U	84	85.92	85.14	24	30
HM-SERIES	42U	78.75	80.67	80.16	24	30



Heat Containment Systems (continued)

Passive and Adaptive Enclosure Heat Containment (AEHC) System

AEHC chimney shown here in through-the-ceiling version

Passive chimney shown here in adjustable and against-the-ceiling version



AEHC chassis (23.5"Wx16.9"Dx11.5"H) host the fans and controller

Example of passive and active chimney systems

Containment Cabinets

- Designed for chimney containment, Belden XHM, XHS and XHMS-XHSS Seismic cabinets feature sealing front mounting rails that separate cold supply air from hot return
- 42" or 48" deep cabinets are recommended for optimal chimney containment performance
- Gasketed solid rear door options and brushed cable entries prevent hot return air from leaking back into computing space
- All X Series cabinets can be equipped with passive or active chimneys

Passive and Active Chimney Systems

- Active system can support up to 30 kW per cabinet for today's extremely high heat loads
- Passive systems rely on the effectiveness of server fans, combined with pressure differential between the cabinet and return spaces
- Passive system capacity peaks around 10 kW (but can be higher) and varies based on chimney length, position in relation to CRAC, return plenum pressure and exhaust air temperature
- Passive and active chimneys are available as through-ceiling chimneys that protrude approximately 2" into the return plenum, and against-the-ceiling chimneys that adjust and feature a rubber gasket for effective sealing against the drop ceiling
- To account for fans and controller units, chimney length for active containment should be sized by deducting 11.5" from distance between cabinet top and return ceiling
- Belden X Series cabinets equipped with containment top panels accept both passive and active chimneys, allowing for easy passive-to- active conversion

AEHC Overview

Belden's active Adaptive Enclosure Heat Containment (AEHC) System is a highly efficient and cost-effective method for cooling cabinets while preventing the mixing of hot and cold air in the data center. When networked, AEHC chimneys allow aggregation of exhaust air volume of entire cabinet pods, enabling real-time control of CRAC units and creating a logical link between the cooling plant and the computing load. This unique attribute allows reduction of cooling-operating costs, particularly in virtualized, clustered computing environments characterized by highly dynamic computing loads.

- AEHC uses high-capacity fans controlled by a pressure sensor to ensure dynamic balancing of intake and exhaust air volumes
- Maintains neutral pressure in the cabinet plenum for highly efficient server fan operation
- Can be networked in a pod/row for redundancy in virtualized, clustered computing environments
- Multiple cabinets can share AEHC chimneys based on hosted computing density (three cabinets per chimney is typical)
- AEHC is highly scalable with chimneys added as needed with increased computing loads
- A pair of hot swappable brushless fans with a combined capacity of 10 kW or 30 kW connect to the AEHC controller, enabling quick and easy capacity upgrades (different capacity fans cannot be used in the same cabinet)
- Fan motors are engineered to ensure longevity, high air displacement and low power consumption for mission-critical facilities
- Ideal for existing data centers, and non-Belden cabinets can be retrofitted with chimney by using a customized adapter plate

Faster.
Easier.
Better.



Heat Containment Systems (continued)

Pressure-based containment control for best use of cooling capacity

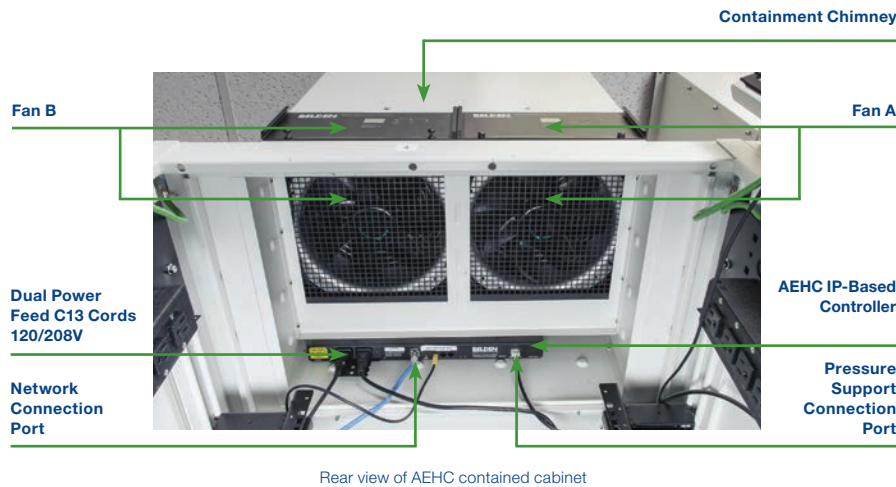

Rear view of AEHC contained cabinet

- The AEHC system is powered (autosensing 120V or 208V) via the cabinet PDUs and accepts two distinct power feeds for redundancy
- A combination of temperature-humidity sensors with the AEHC controller can collect and store environmental data. When networked, real-time data can be accessed via the intuitive user interface or Belden Cormant-CS Infrastructure Management Software using SNMP (MIB file)
- Environmental, mechanical and electrical thresholds and alarms are easy to configure and can be sent directly to e-mail addresses (through an escalation process)

Belden AEHC is comprised of:

- A cabinet configured to accept the AEHC system
- A chassis with a controller and two fans
- A controller for power input and system networking and control
- A pair of AEHC fans per chassis with a combined containment capacity of 10 kW or 30 kW
- A pressure sensor for fan speed control
- A dual-function temperature/humidity sensor to monitor intake air
- An AEHC chimney to provide the physical link between the chassis and return plenum



Embedded software allows each AEHC unit to be fully autonomous. The AEHC controllers have their own IP address, enabling network connection. The AEHC then allows for real-time monitoring of the heat load, temperature and alarm conditions for each IT cabinet.



The threshold setting in Belden's AEHC system software provides early warning alarms for problem conditions. Alarms are automatically reported. Supported Network Protocols: DHCP, HTTPS, SMTP/POP3, HTTP, ICMP, TCP/IP, SNMP, DNS.

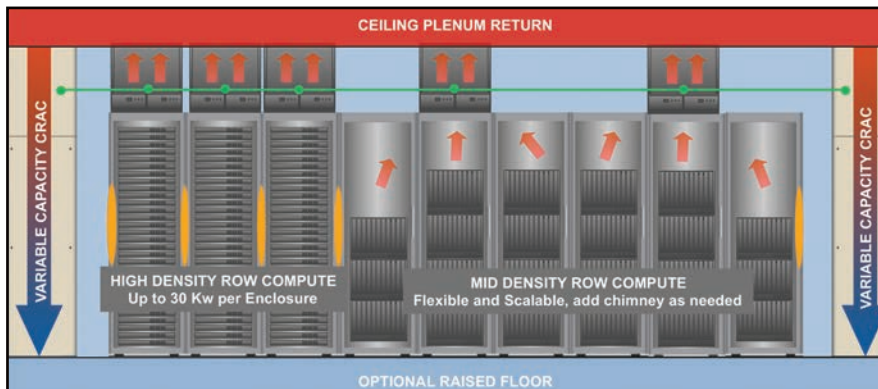

AEHC row function diagram

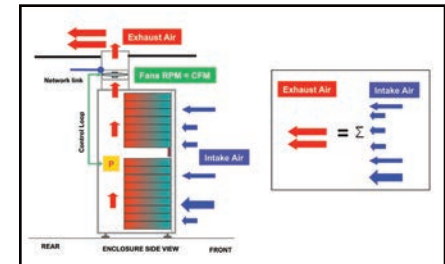

AEHC single cabinet diagram (side view)



Heat Containment Systems (continued) Options and Accessories



AEHC controller



Intelligent hot swappable fan cartridges allow for easy maintenance and system scalability

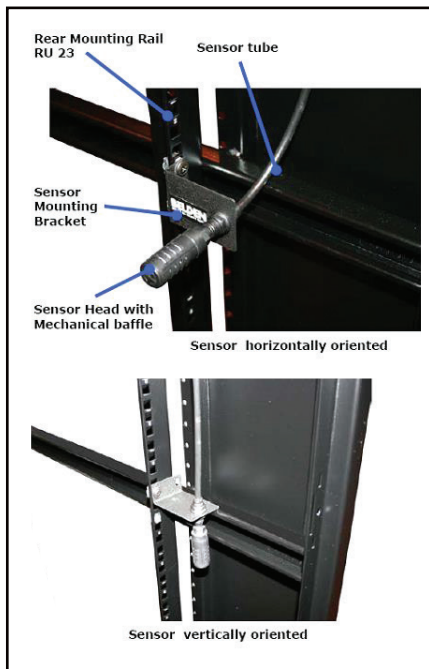

Belden's AEHC System utilizes pressure sensing to dynamically adjust for speed, resulting in perfect balance between intake and exhaust air volume

Passive Chimney – Through Ceiling

HCDP0

Chimney Height			
24	24"	60	60"
33	33"	66	66"
36	36"	72	72"
42	42"	78	78"
48	48"	84	84"
54	54"		

Color	
B	Black
W	CO White

Passive Chimney – Against Ceiling (Adjustable)

HCDPA0

Chimney Height	
24	21"–27"
36	33"–39"
48	45"–51"
60	57"–63"
72	69"–75"
84	81"–87"

Color	
B	Black
W	CO White

AEHC Chimney* – Through Ceiling

HCD0

Chimney Height			
24	24"	60	60"
33	33"	66	66"
36	36"	72	72"
42	42"	78	78"
48	48"	84	84"
54	54"		

Color	
B	Black
W	CO White

AEHC Chimney* – Against Ceiling (Adjustable)

HCD A0

Chimney Height	
24	21"–27"
36	33"–39"
48	45"–51"
60	57"–63"
72	69"–75"
84	81"–87"

Color	
B	Black
W	CO White

Adaptive Cabinet Heat Containment System

Includes (1) Black Chassis, (1) Controller, (2) Fan Cartridges, (1) Pressure Sensor, (1) Temperature/Humidity Sensor, (2) C13 Power Cords, (2) 5-15P Power Cords

HCS0

Containment Capacity	
10	10kW
30	30kW

Color	
B	Black
W	CO White

*Make sure to account for the 11.5" AEHC chassis height when determining the proper chimney height.

Description	Belden Part Number
Other Accessories	
AEHC Controller	
AEHC Controller (1) with Power Cords C13 (2), 5-15P (2)	HCH001
AEHC Fans	
AEHC 10kW AEHC Fan (1) with Digital Display	HCFD10
AEHC 30kW AEHC Fan (1) with Digital Display	HCFD30
AEHC Sensors	
AEHC Dual Function Temperature/Humidity Sensor (1)	HCP002
AEHC Pressure Sensor (1)	HCP001
AEHC Chassis	
AEHC Chassis, Black	HCC001-B
AEHC Chassis, Central Office White	HCC001-W
AEHC Chassis Blank Panels	
AEHC Chassis Blank Panels, includes Blank for Fans and Controller, Black	HCCBP-B
AEHC Chassis Blank Panels, includes Blank for Fans and Controller, Central Office White	HCCBP-W
Chimney Blank Panel for Active or Passive Containment (compatible with 24", 30" and 40" cabinets)	
Black	HCDBP-B
Central Office White	HCDBP-W

Faster.
Easier.
Better.



XHN Series – NEMA 12 Cabinets

Ideal for use in industrial networking



XHN Style NEMA 12 compliant cabinet with front and rear doors, side panels, EIA mounting rails and optional side-mounted air conditioning unit. Part number shown: XH2N45112121

Applications

Designed for dusty environments, Belden XHN Series cabinets allow hosting of networking/control equipment in factories and warehouses and on production floors. Optional air conditioning (AC) units allow temperature control for stand alone applications. Belden has extensive NEMA-style networking cabinet experience and capability to customize solutions.

Design and Structural Features

- NEMA 12 compliant for hosting servers and switches in industrial environments
- Freestanding welded frame with modular construction
- 84"H x 30"W x 36"D or 84"H x 30"W x 42"D
- 19" EIA Mounting rails
- Three-point compression-style lift-and-turn latch system
- Glass front door uses scratch-resistant tempered safety glass

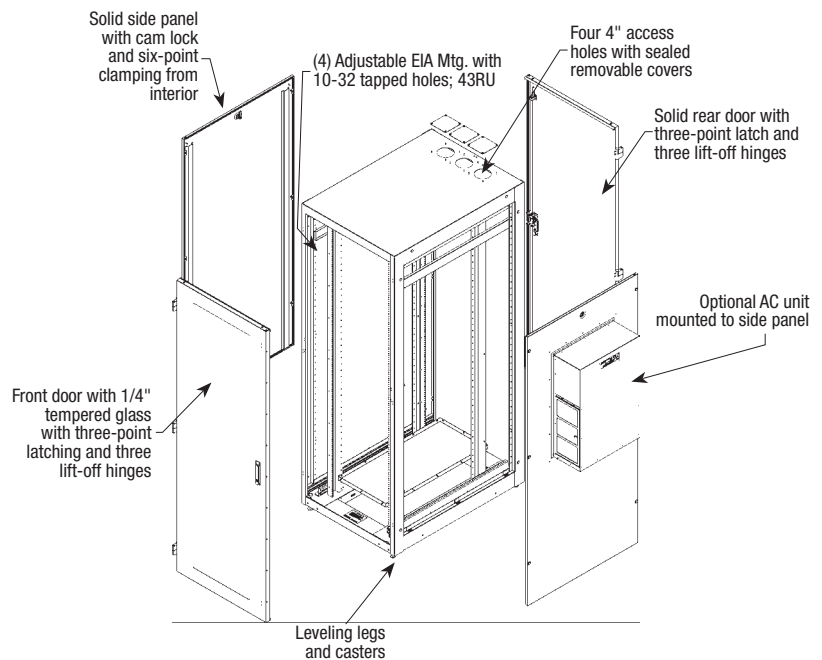

XHN Front with Doors and Panels

Ordering Matrix for NEMA 12 Cabinets

Part number example:

XH2N45112121

XHN Cabinet, 30"Wx42"D frame, 45RU, Black, 19" mount, Sq. hole rails w/ M6 hardware, Glass front door, Solid rear door, Right side with 2500 BTU A/C unit, Left side w/ Solid side panel.

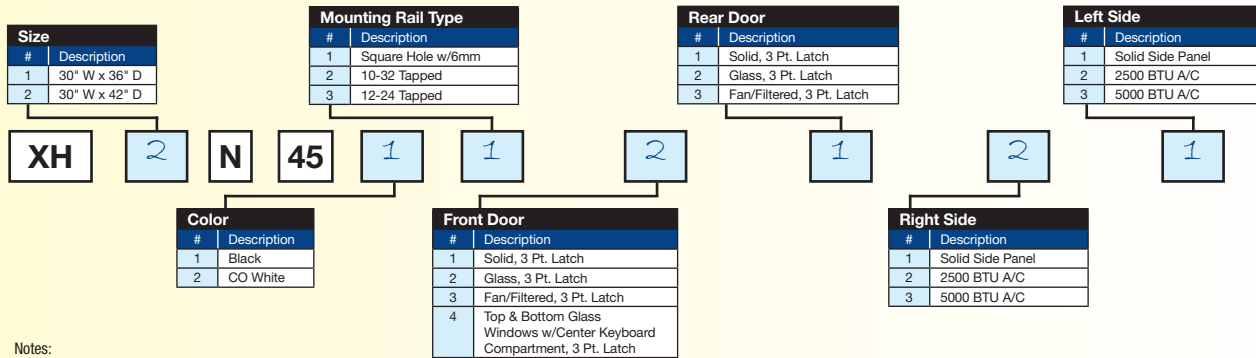

Cabinet Components: Doors and Side Panels

Description	Belden Part Number
Front/Rear Doors	
Solid with 3 Pt. Latching and Locking Swing Handle, Black	HN4530SD01
Solid with 3 Pt. Latching and Locking Swing Handle, White	HN4530SD02
Glass with 3 Pt. Latching and Locking Swing Handle, Black	HN4530GD01
Glass with 3 Pt. Latching and Locking Swing Handle, White	HN4530GD02
Fan/Filtered with 3 Pt. Latching and Locking Swing Handle, Black	HN4530FFD01
Fan/Filtered with 3 Pt. Latching and Locking Swing Handle, White	HN4530FFD02
Top & Bottom Glass Windows w/ Center Keyboard Compartment with 3 Pt. Latching and Locking Swing Handle, Black	HN4530GKD01
Top & Bottom Glass Windows w/ Center Keyboard Compartment with 3 Pt. Latching and Locking Swing Handle, White	HN4530GKD02
Side Panels	
Solid, Locking, Bolt-On Side Panel with Gasket for 45RU x 36" Deep XHN Cabinet, Black	HN4536SP01
Solid, Locking, Bolt-On Side Panel with Gasket for 45RU x 36" Deep XHN Cabinet, White	HN4536SP02
Solid, Locking, Bolt-On Side Panel with Gasket for 45RU x 42" Deep XHN Cabinet, Black	HN4542SP01
Solid, Locking, Bolt-On Side Panel with Gasket for 45RU x 42" Deep XHN Cabinet, White	HN4542SP02



Air-conditioning units

Air Conditioners

Most Belden cabinets can be customized to accept highly efficient air-conditioning units.

Faster.
Easier.
Better.



XHW Series - Wall-Mount Cabinets

Wall-Mount Cabinets are an ideal hosting option in confined spaces



XHW-4830-GD - Closed



XHW-4830-GD - Open

Applications

Wall-mount cabinets provide IT/networking hosting in spaces that often serve another primary function, or where space optimization is critical. They are designed for applications that require secure hosted devices and are ideal for locations where floor mounting space is limited (retail establishments, schools and offices).

Available in mounting unit increments of 12RU, 19RU and 26RU, Belden Wall-Mount Cabinets offer great aesthetics, rugged construction, optimized equipment access and flexible cable management and access features.

Design and Structural Features

- Sturdy welded steel construction
- Weight capacity of 300 lbs. of load
- Durable black powder-coat finish
- Front door options: perforated, clear polycarbonate or solid front
- Door-swing direction field is reversible
- Lockable front door and rear section
- Open rear section for cable access through mounting wall
- Laser knockouts for conduit and cable entry on the top and bottom rear section
- Side vent pattern has provisions to mount 6, 8 or 12 fans, cover plates or filters, depending on height of wall mount
- Several accessory options are available:
 - Fan kits
 - Filter kits
 - Vent covers
 - Brush kits
 - Wall-mounting bracket kit
- Includes one pair of #12-24 tapped 19" EIA depth-adjustable mounting rails (includes mounting hardware). Additional pair of 12-24 tapped rails can be ordered separately (see page 34-35 for part numbers)
- Swing-out mid-section for rear access to equipment
- Vented sides for proper heat dissipation



XHWFILTERKIT

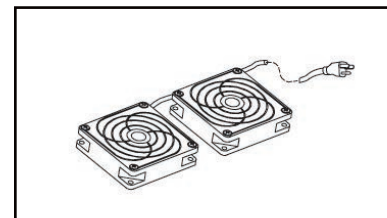

XHWFANKIT115V - Fan Assembly Kit

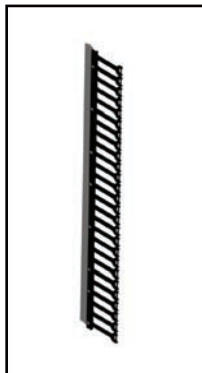

HWFS_>*
Vertical Finger Strip
Manager

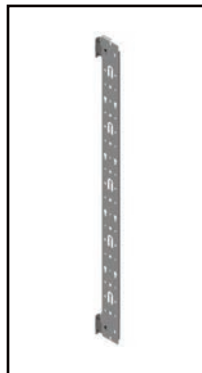

HWVMP01_01*
Vertical Finger Strip
Manager



XHW_ _BBD*
Plywood Backboard
Kit

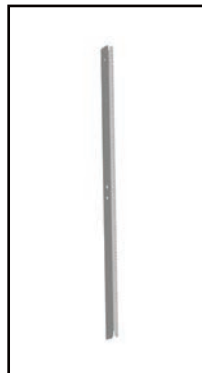

XHW_ _RLS1224* (1)
Pair of EIA Rails #12-24
with hardware included

_ _* Denotes height from table

Field Data	Enclosure Height
24	24.000"
36	36.000"
48	48.000"



XHW Series - Wall-Mount Cabinets (continued)

Racks and Cabinets

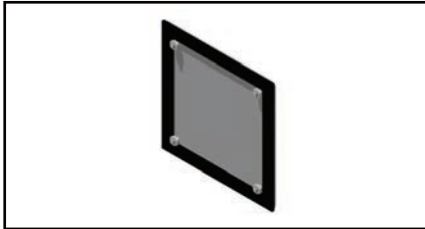

XHWCOVERKIT



XHWMBKKT



XHWBRUSHKIT

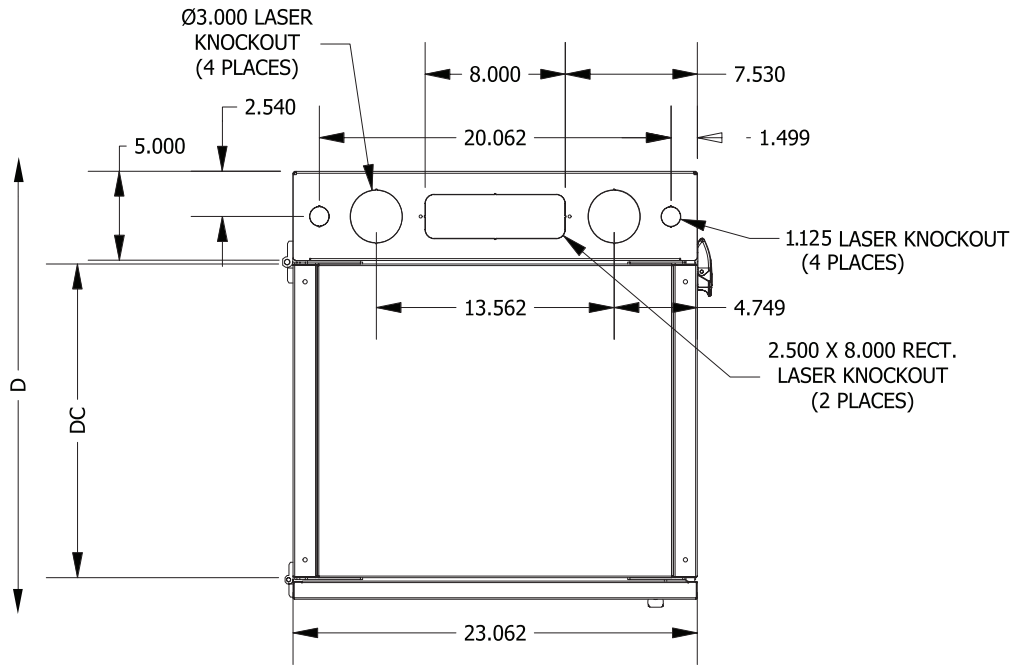

Ordering Information

Belden Part Number	W	H	D	DC Mid-Section	Cable Entry	Vented Slots	Rack Unit (RU)	Door Type	Weight	Weight Capacity
24" - 12RU Wall-Mount Cabinets										
XHW-2406-GD	23.062"	23.75"	6.0"	N/A	(2) 2.5" x 8.0"	N/A	12	Polycarbonate	25 lbs	300 lbs
XHW-2406-SD	23.062"	23.75"	6.0"	N/A	(2) 2.5" x 8.0"	N/A	12	Solid	30 lbs	300 lbs
XHW-2406-PD	23.062"	23.75"	6.0"	N/A	(2) 2.5" x 8.0"	N/A	12	Perforated	20 lbs	300 lbs
XHW-2424-GD	23.062"	23.75"	24.0"	17.60"	(2) 2.5" x 8.0"	2 Per Side	12	Polycarbonate	115 lbs	300 lbs
XHW-2424-SD	23.062"	23.75"	24.0"	17.60"	(2) 2.5" x 8.0"	2 Per Side	12	Solid	125 lbs	300 lbs
XHW-2424-PD	23.062"	23.75"	24.0"	17.60"	(2) 2.5" x 8.0"	2 Per Side	12	Perforated	110 lbs	300 lbs
XHW-2430-GD	23.062"	23.75"	30.0"	17.60"	(2) 2.5" x 8.0"	2 Per Side	12	Polycarbonate	125 lbs	300 lbs
XHW-2430-SD	23.062"	23.75"	30.0"	17.60"	(2) 2.5" x 8.0"	2 Per Side	12	Solid	135 lbs	300 lbs
XHW-2430-PD	23.062"	23.75"	30.0"	17.60"	(2) 2.5" x 8.0"	2 Per Side	12	Perforated	120 lbs	300 lbs

Description	Belden Part Number
24" Wall-Mount Accessories	
Vertical Cable Manager - mounts in rear section using brackets or in mid-section on rail struts	HWVMP012401
Vertical Finger Strip Manager	HWFS24
(1) Pair of EIA Rails tapped #12-24 with (20) pcs mounting hardware included	XHW24RLS1224
Plywood Backboard Kit - mounts in rear section using brackets	XHW24BBD

Faster.
Easier.
Better.



XHW Series – Wall-Mount Cabinets (continued)

Belden Part Number	W	H	D	DC Mid-Section	Cable Entry	Vented Slots	Rack Unit (RU)	Door Type	Weight	Weight Capacity
36" - 19RU Wall-Mount Cabinets										
XHW-3606-GD	23.062"	36.00"	6.0"	N/A	(2) 2.5" x 8.0"	N/A	19	Polycarbonate	45 lbs	300 lbs
XHW-3606-SD	23.062"	36.00"	6.0"	N/A	(2) 2.5" x 8.0"	N/A	19	Solid	55 lbs	300 lbs
XHW-3606-PD	23.062"	36.00"	6.0"	N/A	(2) 2.5" x 8.0"	N/A	19	Perforated	40 lbs	300 lbs
XHW-3624-GD	23.062"	36.00"	24.0"	17.60"	(2) 2.5" x 8.0"	4 Per Side	19	Polycarbonate	137 lbs	300 lbs
XHW-3624-SD	23.062"	36.00"	24.0"	17.60"	(2) 2.5" x 8.0"	4 Per Side	19	Solid	147 lbs	300 lbs
XHW-3624-PD	23.062"	36.00"	24.0"	17.60"	(2) 2.5" x 8.0"	4 Per Side	19	Perforated	127 lbs	300 lbs
XHW-3630-GD	23.062"	36.00"	30.0"	23.60"	(2) 2.5" x 8.0"	4 Per Side	19	Polycarbonate	142 lbs	300 lbs
XHW-3630-SD	23.062"	36.00"	30.0"	23.60"	(2) 2.5" x 8.0"	4 Per Side	19	Solid	152 lbs	300 lbs
XHW-3630-PD	23.062"	36.00"	30.0"	23.60"	(2) 2.5" x 8.0"	4 Per Side	19	Perforated	137 lbs	300 lbs

Description	Belden Part Number
36" Wall-Mount Accessories	
Vertical Cable Manager - mounts in rear section using brackets or in mid-section on rail struts	HWVMP013601
Vertical Finger Strip Manager	HWFS36
(1) Pair of EIA Rails tapped #12-24 with (20) pcs mounting hardware included	XHW36RLS1224
Plywood Backboard Kit - mounts in rear section using brackets	XHW36BBD

Belden Part Number	W	H	D	DC Mid-Section	Cable Entry	Vented Slots	Rack Unit (RU)	Door Type	Weight	Weight Capacity
48" - 26RU Wall-Mount Cabinets										
XHW-4806-GD	23.062"	48.25"	6.0"	N/A	(2) 2.5" x 8.0"	N/A	26	Polycarbonate	50 lbs	300 lbs
XHW-4806-SD	23.062"	48.25"	6.0"	N/A	(2) 2.5" x 8.0"	N/A	26	Solid	60 lbs	300 lbs
XHW-4806-PD	23.062"	48.25"	6.0"	N/A	(2) 2.5" x 8.0"	N/A	26	Perforated	45 lbs	300 lbs
XHW-4824-GD	23.062"	48.25"	24.0"	17.60"	(2) 2.5" x 8.0"	6 Per Side	26	Polycarbonate	140 lbs	300 lbs
XHW-4824-SD	23.062"	48.25"	24.0"	17.60"	(2) 2.5" x 8.0"	6 Per Side	26	Solid	150 lbs	300 lbs
XHW-4824-PD	23.062"	48.25"	24.0"	17.60"	(2) 2.5" x 8.0"	6 Per Side	26	Perforated	135 lbs	300 lbs
XHW-4830-GD	23.062"	48.25"	30.0"	17.60"	(2) 2.5" x 8.0"	6 Per Side	26	Polycarbonate	150 lbs	300 lbs
XHW-4830-SD	23.062"	48.25"	30.0"	17.60"	(2) 2.5" x 8.0"	6 Per Side	26	Solid	160 lbs	300 lbs
XHW-4830-PD	23.062"	48.25"	30.0"	17.60"	(2) 2.5" x 8.0"	6 Per Side	26	Perforated	145 lbs	300 lbs

Description	Belden Part Number
48" Wall-Mount Accessories	
Vertical Cable Manager - mounts in rear section using brackets or in mid-section on rail struts	HWVMP014801
Vertical Finger Strip Manager	HWFS48
(1) Pair of EIA Rails tapped #12-24 with (20) pcs mounting hardware included	XHW48RLS1224
Plywood Backboard Kit - mounts in rear section using brackets	XHW48BBD

Description	Belden Part Number
Wall-Mount Optional Accessories	
Fan Assembly (2-4" Diameter Fans - 115V 5-15P Plug, 160 CFM with Guard)	XHWFANKIT115V
Fan Assembly (2-4" Diameter Fans - 230V C14 Plug, 160 CFM with Guard)	XHWFANKIT230V
Hybrid Wall-Mount Easy Mount Wall Bracket Kit	XHWMBKT
Rear Section Brush Kit - Mounts over 2.5" x 8.0" cutout	XHWBRUSHKIT
Gasketed Cover Plate Kit - Mounts over fan areas in the mid-section (1 Pair)	XHWCVERKIT
2) Filter Housings - Mount to Side Panels of Center Section, attach from inside	XHWFILTERKIT
(4) Rubber Feet - Mount to bottom of center section	XHWF00TKIT
Grommet Kit (2) 1.125" & (2) 3.0" Grommets - for Rear Section Cable Entry Holes	XHWGROMMETKIT
12-24 Mounting Hardware (Bag of 25)	8917-0125



SecurePatch® Open Rack Security Door



Wall-Mounted SecurePatch BSP-22U-12SK



11U 6" Deep - BSP-11U-6PK

SecurePatch provides security for new and existing network components in an open 19" equipment rack. The SecurePatch cover provides a security solution to only the section of the rack space you need. Safeguard against unauthorized patch cord movement by retrofitting loaded equipment racks with the added security of a lockable door.

Benefits

- Adds security without network downtime
- Controls rack access
- Provides second-level lock security
- Clamshell design allow back to back mounting of SecurePatch for securing front and rear
- No need to re-terminate
- Mounting flange allows one person to install each unit

Features

- Can be rack or Wall-Mounted on a backboard
- Slotted mounting flange allows for single person install
- Multiple side knockout options allow for low-high-capacity cable feed through
- Connecting bracket enables 11U/22U units to be connected in any combination while allowing patch cord pass through from one unit to another

Product Specifications

- 16 gauge cold rolled steel
- 19" Rack-Mounting per EIA-310-D
- Finish: black powder coat
- Door options: steel, mesh or plexiglass door
- Keyed locks standard on door
- Combination locks available
- Ships unassembled
- Easy-to-follow assembly instructions



BSP-D44U-6PK

Ordering Information

Description	Height	Depth	Belden Part Number
11U SecurePatch Complete Units (standard black powder coat)			
11U SecurePatch with keyed door	19.25"	6.00"	BSP-11U-6(X)
11U SecurePatch with keyed door	19.25"	12.00"	BSP-11U-12(X)
22U SecurePatch Complete Units (standard black powder coat)			
22U SecurePatch with keyed door	38.50"	6.00"	BSP-22U-6(X)
22U SecurePatch with keyed door	38.50"	12.00"	BSP-22U-12(X)
44U SecurePatch Kits Complete Units (standard black powder coat)			
(2) 22U SecurePatch w/ connector brackets, keyed doors	77.00"	6.00"	BSP-44U-6(X)
(4) 22U front and rear kit with keyed doors	77.00"	6.00"	BSP-D44U-6(X)

Replace (X) with door code: PK= Plexiglas, MK=Mesh, SK=Steel

SecurePatch Accessories

Description	Quantity	Belden Part Number
Connecting bracket - for retrofitting 2 SecurePatch together	1	BSP-CBRKT
Quarter-turn with 3 number combination lock	1	BSP-LOCK-C1
Adjustment plates for front and rear rack installation	2-pack	BSP-ADPLATE*

*Note: BSP-ADPLATE encloses the gap between two SecurePatch covers installed back to back on a 3" deep equipment rack. When the adjustment plates are installed, inside usable mounting space is reduced by 2U.

Faster.
Easier.
Better.



Consolidation/MDU Enclosures: In-Suite Distribution

Target Markets: Hospitality & Dwelling, Public Venue

To meet the needs of multi-dwelling, hospitality and public venues, Belden offers a tailored solution for terminating optical network terminals (ONTs) in the suite, breaking out signals and routing to the unit's data, voice, video and wireless.

Wall Enclosures

Designed to house connectivity and provide cable routing options. Knockouts located in the bottom are designed to accommodate single or full-width AC power modules, mini and universal DC power supplies. Available in 14-, 21-, 28- and 42-inch sizes to suit your needs.

- Enclosure capable of housing different types of ONTs

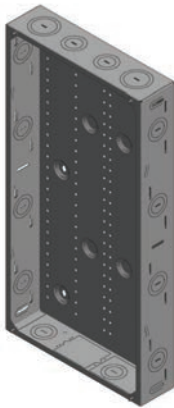

XRES2114

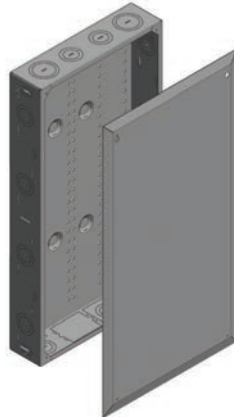

XRES2114FC

Modules

- Coax Splitters
 - Passive: 1X2, 1X3
 - Active: 1X5, 1X9
- Input Distribution Panel: Allows voice split of 1-4 into 12 output lines. Includes security line as well.
- MoCA ready (1125-1675 MHz)
- Low output-to-output isolation in MoCA band
- Built-in PoE filter on input port
- All passive voice modem/eMTA port
- Return loss saver (RLS) technology
- Dual-color monitoring LED
- UL Listed for bonding
- Downstream unity gain
- Upstream unity gain
- Corrosion-resistant housing
- RoHS compliant



PPC-GHS-4E



PPC-9M-U/U

Wall Enclosures

Description	Belden Part Number
14" Enclosure, 14.0" high x 14.38" wide x 3.63" deep	XRES1414
14" Vented Hinged Door	XRES1414VHD
14" Screw on Flush Cover	XRES1414FC
21" Enclosure, 21.0" high x 14.38" wide x 3.63" deep	XRES2114
21" Vented Hinged Door	XRES2114VHD
21" Screw on Flush Cover	XRES2114FC
28" Enclosure, 28.0" high x 14.38" wide x 3.63" deep	XRES2814
28" Vented Hinged Door	XRES2814VHD
28" Screw on Flush Cover	XRES2814FC
42" Enclosure, 42.0" high x 14.38" wide x 3.63" deep	XRES4214
42" Vented Hinged Door	XRES4214VHD
42" Screw on Flush Cover	XRES4214FC

Brackets

Description	Belden Part Number
Mini Cable Manager Bracket	XRESBR-007
90° front access	XRESBR-005
Front access, 21 POS	XRESBR-006
PON box bracket	XRESBR-009

Splitters

Description	Belden Part Number
Passive	
2-Way Digital Splitter, 1000 MHz	PPC-GHS-2E
3-Way Digital Splitter, Unbalanced, 1000 MHz	PPC-GHS-3E
4-Way Digital Splitter, 1000 MHz	PPC-GHS-4E
Active	
Entry, 5-output, 1002 MHz, Downstream Unity Gain, Upstream Unity Gain	PPC-5M-U/U
Entry, 5-output, 1002 MHz, Downstream Unity Gain, Upstream Unity Gain, w/Power Inserter	PPC-5M-U/UPI
Entry, 5-output, 1002 MHz, Downstream Unity Gain, Upstream Unity Gain, Power Supply w/built-in PI	PPC-5M-U/UPS
Entry, 9-output, 1002 MHz, Downstream Unity Gain, 0 db Loss Upstream	PPC-9M-U/U
Entry, 9-output, 1002 MHz, Downstream Unity Gain, 0 db Loss Upstream, w/Power Inserter	PPC-9M-U/UPI
Entry, 9-output, 1002 MHz, Downstream Unity Gain, 0db Loss Upstream, Power Supply w/built-in PI	PPC-9M-U/UPS

Voice Splitter

Description	Belden Part Number
4 P In, 4-Pair 110 IDC Voice	AX107623

Zone Enclosures

Application Description

Ceiling- or floor-based zone connectivity replaces traditional homeruns to telecom rooms. Feeder category cables or pre-terminated cables are directed to a central distribution point in the zone where they interconnect to individual cable runs that fan out to each workstation outlet.

Zone connectivity provides a way to keep most cabling permanent and undisturbed while making moves, adds and changes (MACs) easier.

Enclosures

Versatile solution

- 7U Active Ceiling Enclosure
- 5U Passive Ceiling Enclosure
- 8U Active Ceiling Enclosure
- 8U Passive Ceiling Enclosure
- 2'x2' / 2'x4'
- Ceiling/floor
- Active/passive
- Removable door

Robust

- UL 50/UL 1863/UL 2043
- Fire-rated sealing kit
- Plenum rated

Zone enclosures are compatible with other Belden products, including the Pre-loaded and empty REVConnect and KeyConnect Patch Panels.



Zone Enclosures

Description	Part Class	Belden Part Number
Raised-Floor Zone Enclosures		
2U + 2U Passive Raised Floor Enclosure w/Rotating Brackets, 24"W x 24"H x 4.00"D	Passive	XUFPE25254-S01
4U + 4U Passive Raised Floor Enclosure w/Rotating Brackets, 24"W x 24"H x 7.00"D	Passive	XUFPE25257-S01
7U Active Raised Floor Enclosure w/Rotating Brackets, 24"W x 24"H x 12"D	Active	XUFAE252512-S01
11U Passive Raised Floor Enclosure for Patch Panels, 24"W x 24"H x 12"D	Passive	XUFPE252512-S01
Ceiling Zone Enclosures		
7U Active Ceiling Enclosure w/NEMA Box-Access Ports, 24"W x 24"H x 12"D, White	Active	XCAE242412-S01
Cable Consolidation Ceiling Enclosure for Wiring Blocks, 24"W x 24"H x 12"D, White	Passive	XCPE242412-S02
5U Passive Ceiling Enclosure with Equipment Bracket, 24"W x 24"H x 12"D, White	Passive	XCPE242412-S01
8U Active Ceiling Enclosures w/NEMA Box, 4 Access Ports, 24"W x 48"H x 12"D, White	Active	XCAE244812-S01
4U Passive Ceiling Enclosure, 4 Access Ports, 24"W x 48"H x 12"D, White	Passive	XCPE244812-S01
8U Passive Ceiling Enclosure, 4 Access Ports, 24"W x 48"H x 12"D, White	Passive	XCPE244812-S02
Zone Enclosures Accessories		
White Knob Replacement Non-Lock 1/4-Turn for A1222 & A1224	Standard	XLKS-1-S01
Locking Door for Zone Floor Enclosures	Standard	XLDES-S01
Replacement Fan for the 2 X 2 Ceiling Active Zone Enclosures	Active	XCAERF2X2-S01
Replacement Fan for the 2 X 2 Ceiling Active Zone Enclosures	Active	XCAERF2X4-S01



Faster.
Easier.
Better.



2- and 4-Post Distribution Rack Systems

Modular High-Density Racking System (HDRS) for network cross-connect



Applications

These high-reliability products have been designed specifically for networking environments — from telecom closets to world-class data centers — to help you make the best use of valuable real estate and simplify MACs (moves, adds and changes).

The HDRS is a well-engineered cross connect and hosting platform that offers you a high level of versatility and flexibility in systems design for ultimate network density and manageability.

How It Works

Create exactly the racking system you need from our selection of steel and aluminum distribution and server racks, combined with more than 50 standard cable management components and accessories. These items have been designed for complete compatibility and integration. The components include:

- Distribution and server racks in aluminum or steel; knockdown or welded; 2 or 4 posts
- Choice of low- or high-density vertical cable managers in single- or double-sided configurations
- High-density vertical manager half door allows easy cable access and hinging of the doors to both right and left side
- Horizontal cable managers with bend radius control and double-hinge cover
- **Accessories:** Retention Gates, Divider Bars, Transition Channels and more

How to Order

Select any of the Distribution and Server Rack styles. Select any of the Vertical Cable Managers listed for Distribution and Server Racks.

Choose any of the Accessories for the BHV Vertical Managers, Horizontal Managers or Transition Channels (See pages 44-45 for Technical Specifications and Options Tables).

HDRS Vertical Manager Capacity

Single-Sided Manager				# of Cable 35% Fill	
High	Low	Width (in.)	Depth (in.)	Cat 6 0.250" dia.	Cat 6A 0.295" dia.
BHVH003	BHVL003	3.6	9.40	194	126
BHVH006	BHVL006	6.0	9.40	321	209
BHVH010	BHVL010	10.0	9.40	535	348
BHVH012	BHVL012	12.0	9.40	642	417

Double-Sided Manager				# of Cable 35% Fill	
High/High	High/Low	Width (in.)	Depth (in.)	Cat 6 0.250" dia.	Cat 6A 0.295" dia.
BHVHH03	BHVHL03	3.6	18.80	388	252
BHVHH06	BHVHL06	6.0	18.80	642	417
BHVHH10	BHVHL10	10.0	18.80	1070	696
BHVHH12	BHVHL12	12.0	18.80	1283	835



HDRS Modular High-Density Racking System

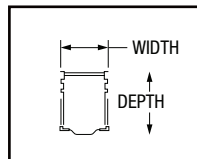

Single-Sided

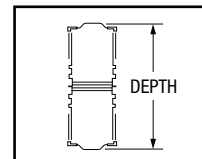

Double-Sided

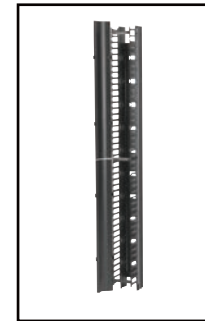

BHVH006*
High-Density, Single-Sided
Vertical Manager

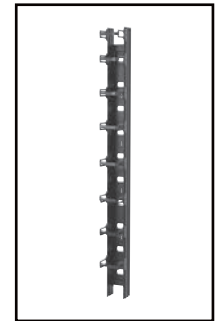

BHVL006*
Low-Density, Single-Sided
Vertical Manager

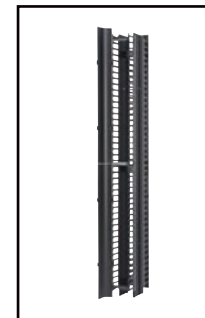

BHVHH06
High-Density, Double-Sided
Vertical Manager

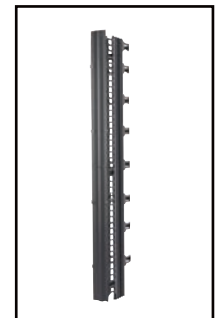

BHVHL06
High/Low-Density, Double-
Sided Vertical Manager

*High- and low-density vertical manager shown here with optional back covers, BHBC06X.



2- and 4-Post Distribution Rack Systems (continued) High-Density Racking System Features

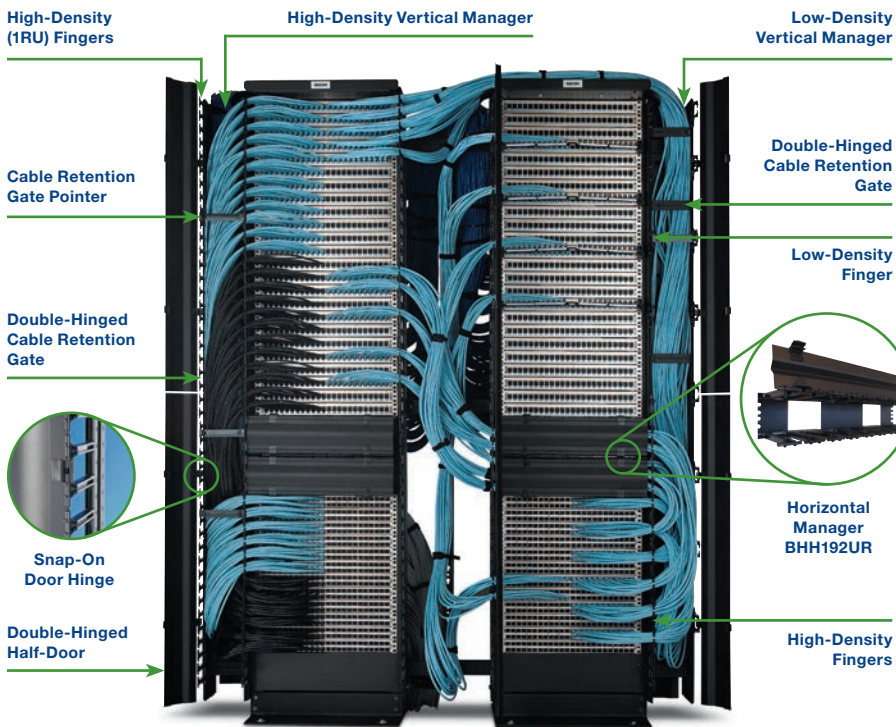

Vertical Manager Part Sets

- Includes a complete set of necessary components, including doors (on high-density managers), gates, push-in fasteners, cable strap mounts, cable retainer bars and mounting hardware

Modular, Removable Finger Sections

- Available in high or low density, finger sections can be easily removed during reconfigurations and easily replaced as needed
- High-density 11RU sections easily screw into vertical managers and align with the rack units, eliminating horizontal managers

System Scalability

- The HDRS is easily reconfigured and modified to handle future system growth, add-ons or changes

Compatibility of Vertical Managers

- Compatible with any EIA-310-D compliant 2- and 4-post racks

Mixed-Media Application

- Designed to handle both copper and optical fiber structured cable networks

Accessory Mounting Holes

- 1/4" diameter mounting holes along length of each vertical manager enable easy attachment of accessories, like cable bundle fasteners

Any-Point-to-Any-Point Routing Capability

- Cable can be easily routed from one patch panel to another within the same rack, to the back of the rack or to an adjacent rack while still maintaining proper cable bend radius

Easy Installation

- Only standard hand tools are required for quick installation and simple field reconfiguration and modification

Great Aesthetics

- Professional flat-black finish is suitable for any world-class telecom environment
- Central office white color option allows for seamless integration where light-colored cabinets are used, improving visibility

Unmatched Density

- Designed to work seamlessly with Belden IBDN copper and fiber systems, cable management fingers align with rack RUs for easy routing of patch cords to vertical managers, eliminating the need for horizontal managers

High Level of Modularity

- Enables ease of removal or reconfiguring Belden's wide selection of accessories and components
- Interchangeable cable retention gates, doors, fingers and accessories adapt to specific needs

Faster.
Easier.
Better.



2- and 4-Post Distribution Rack Systems (continued)

Suitable for single-rack to multi-rack high-density cross-connects

Applications

Belden offers a complete line of open racks and rack accessories, from single-rack applications (retail, telecom closets) to high-density, multi-rack patching and switching fields (computer room, data centers, central offices). Belden's unique cable and connectivity expertise was central in the design of a feature-rich racking system that offers ease of installation, easy MACs and high levels of scalability.

Rack Features: 2- and 4-Post

- EIA-310-D compliant, choice of 19" and 23" mounting
- Consult customer service for 23" rack and accessories (horizontal managers)
- Equipment mounting hardware is included
- 2-post rack uprights are front and rear tapped
- Easy rack unit identification for faster install
- Grounding stud standard on all 2-post and 4-post racks
- Steel or aluminum construction
- Seismic certified options
- Knockdown or welded construction
- 4-post racks are adjustable, providing for 28", 32" and 36" depths

Color

- Black (standard)
- Central office white available on request



Zone 4 Seismic-Rated Distribution Rack Type XDRS
Part No. Shown: XDRS8419-610

Dimensions

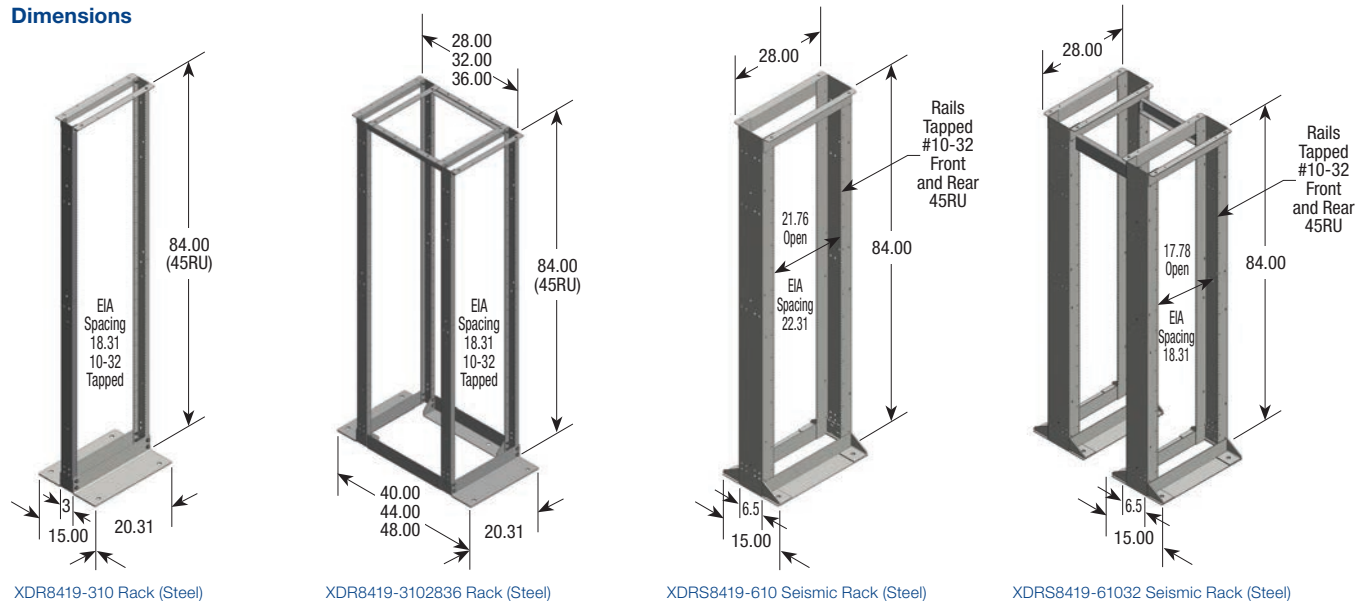

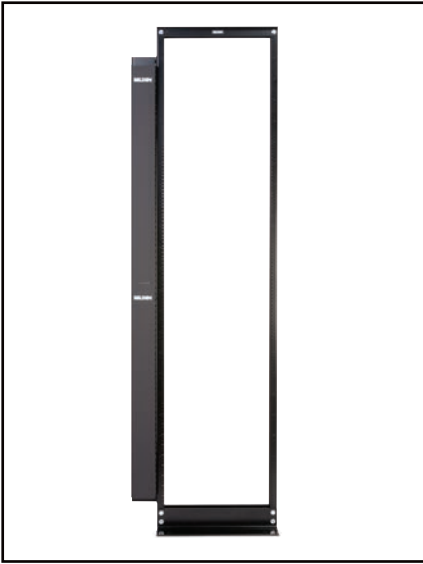

XDR8419-310N1M and XDR8419-312N1M



XDR8419-310N2M and XDR8419-312N2M

2- and 4-Post Distribution Rack Systems (continued)

Technical Specifications

Ordering Information

Description	Weight	Mounting**	Load Capacity	Height/Rack Spaces	Belden Part Number
2-Post Distribution Racks – Steel – Knockdown*					
#10-32 Tapped 3" Vertical Upright w/Angle Base	63 lbs	19"	1,000 lbs	84"/45RU	XDR8419-310N
#12-24 Tapped 3" Vertical Upright w/Angle Base	63 lbs	19"	1,000 lbs	84"/45RU	XDR8419-312N
Square Hole with M6 cage nut, 3" Vertical Upright w/Angle Base	63 lbs	19"	1,000 lbs	84"/45RU	XDR8419-3M6
#10-32 Tapped 6" Vertical Upright w/Angle Base	81 lbs	19"	1,000 lbs	84"/45RU	XDR8419-610
#12-24 Tapped 6" Vertical Upright w/Angle Base	81 lbs	19"	1,000 lbs	84"/45RU	XDR8419-612
2-Post Distribution Racks Kit – Steel – Knockdown*					
#10-32 Tapped 3" Vertical Upright w/Angle Base, Includes One 4" x 4" Vertical Manager with Snap-On Cover (part # VCMFDR4X4)	76 lbs	19"	1,000 lbs	84"/45RU	XDR8419-310N1M
#10-32 Tapped 3" Vertical Upright w/Angle Base, Includes Two 4" x 4" Vertical Manager with Snap-On Cover (part # VCMFDR4X4)	89 lbs	19"	1,000 lbs	84"/45RU	XDR8419-310N2M
#12-24 Tapped 3" Vertical Upright w/Angle Base, Includes One 4" x 4" Vertical Manager with Snap-On Cover (part # VCMFDR4X4)	76 lbs	19"	1,000 lbs	84"/45RU	XDR8419-312N1M
#12-24 Tapped 3" Vertical Upright w/Angle Base, Includes Two 4" x 4" Vertical Manager with Snap-On Cover (part # VCMFDR4X4)	89 lbs	19"	1,000 lbs	84"/45RU	XDR8419-312N2M
2-Post Distribution Racks – Steel – Welded					
#10-32 Tapped 3" Vertical Upright w/Angle Base – Welded	66 lbs	19"	1,000 lbs	84"/45RU	XDR8419-310W
#12-24 Tapped 3" Vertical Upright w/Angle Base – Welded	66 lbs	19"	1,000 lbs	84"/45RU	XDR8419-312W
2- and 4-Post Zone 4 Seismic Distribution Racks – Steel – Welded***					
2-Post Seismic Rack, #10-32 Tapped 6" Vertical Upright w/Angle Base	105 lbs	19"	900 lbs	84"/45RU	XDRS8419-610
4-Post Seismic Rack, 28" Deep, #10-32 Tapped 6" Vertical Upright w/Angle Base	215 lbs	19"	900 lbs	84"/45RU	XDRS8419-61028
4-Post Seismic Rack, 32" Deep, #10-32 Tapped 6" Vertical Upright w/Angle Base	220 lbs	19"	900 lbs	84"/45RU	XDRS8419-61032
2-Post Distribution Racks – Aluminum – Knockdown*					
#12-24 Tapped, Black, Knockdown 3" Vertical Upright	30 lbs	19"	1,200 lbs	84"/45RU	BHRR194
4-Post Distribution Racks – Steel – Knockdown*					
4-Post Rack with Adjustable Depth 28"-32"-36", #10-32 Tapped 3" Vertical Upright w/Angle Base	115 lbs	19"	1,500 lbs	84"/45RU	XDR8419-3102836
4-Post Rack with Adjustable Depth 28"-32"-36", #12-24 Tapped 3" Vertical Upright w/Angle Base	115 lbs	19"	1,500 lbs	84"/45RU	XDR8419-3122836
4-Post Rack with Adjustable Depth 28"-32"-36", M6 Cage Nut 3" Vertical Upright w/Angle Base	115 lbs	19"	1,500 lbs	84"/45RU	XDR8419-3M62836
4-Post Server Rack – Steel – Welded****					
XHM Series Black Frame with (4) Adjustable Mounting Rails, Square Hole Type with 6 mm Mounting Hardware Included. Frame Size 24"W x 42"D x 84"H (45RU), Includes Levelers and Casters	240 lbs	19"	2,000 lbs	85"/45RU	XH3M45-1100000
Rack Accessories					
Copper Isolated Vertical Rack Busbar Kit for 84" Rack					XDR8419VGB01
Glasic Isolation Pad Kit for XDR/BHRR Series 2-Post Racks. Includes (2) Glasic Isolation Pads and Hardware					XDRGIK-19
PDU Bracket Kit for XDR Rack, 4" Long, Black					XDRPDUK401

* Knockdown rack shipped not assembled, assembly hardware is included

** For EIA-23" mounting consult Belden customer service

*** 4-post seismic rack is made of two welded 2-post rack structures, linked with front to rear member, shipped unassembled

**** 4-post server rack is not compatible with vertical managers (see page 21)

Faster.
Easier.
Better.



2- and 4-Post Distribution Rack Managers and Accessories



Ordering Information

Description	Belden Part Number
Vertical Cable Managers	
Value Vertical Manager with Snap-On Cover 4"W x 4"D x 84"H, Black*	VCMFDR4X4
Single-Sided High-Density Vertical Manager w/Doors, 3 5/8"W x 84"H, Black	BHVO03
Single-Sided High-Density Vertical Manager w/Doors, 6"W x 84"H, Black	BHVO06
Single-Sided High-Density Vertical Manager w/Doors, 8"W x 84"H, Black	BHVO08
Single-Sided High-Density Vertical Manager w/Doors, 10"W x 84"H, Black	BHVO10
Single-Sided High-Density Vertical Manager w/Doors, 12"W x 84"H, Black	BHVO12
Single-Sided Low-Density Vertical Manager w/o Doors, 3 5/8"W x 84"H, Black	BHVL003
Single-Sided Low-Density Vertical Manager w/o Doors, 6"W x 84"H, Black	BHVL006
Single-Sided Low-Density Vertical Manager w/o Doors, 10"W x 84"H, Black	BHVL010
Single-Sided Low-Density Vertical Manager w/o Doors, 12"W x 84"H, Black	BHVL012
Double-Sided High-Density Vertical Managers w/Doors, 3 5/8"W x 84"H, Black	BHVH003
Double-Sided High-Density Vertical Managers w/Doors, 6"W x 84"H, Black	BHVH006
Double-Sided High-Density Vertical Managers w/Doors, 8"W x 84"H, Black	BHVH008
Double-Sided High-Density Vertical Managers w/Doors, 10"W x 84"H, Black	BHVH010
Double-Sided High-Density Vertical Managers w/Doors, 12"W x 84"H, Black	BHVH012
High/Low-Density Vertical Manager w/Front Door, 3 5/8"W x 84"H, Black	BHVHL03
High/Low-Density Vertical Manager w/Front Door, 6"W x 84"H, Black	BHVHL06
High/Low-Density Vertical Manager w/Front Door, 10"W x 84"H, Black	BHVHL10
High/Low-Density Vertical Manager w/Front Door, 12"W x 84"H, Black	BHVHL12
Accessories for BHV Vertical Managers	
3 5/8"W, Black, Vertical Manager Backcover	BHBC03X
6"W, Black, Vertical Manager Backcover	BHBC06X
10"W, Black, Vertical Manager Backcover	BHBC10X
12"W, Black, Vertical Manager Backcover	BHBC12X
3 5/8"W, Black, Vertical Manager Doors (1 pr)	BHDK03X
6"W, Black, Vertical Manager Doors (1 pr)	BHDK06X
10"W, Black, Vertical Manager Doors (1 pr)	BHDK10X
12"W, Black, Vertical Manager Doors (1 pr)	BHDK12X
Slack Management Spool Kit, Black	BHSP020
Slack Management Spools (2), Black	BHSP020
Gate Kit, 3 5/8"W, Black	BHGL03X
Gate Kit, 6"W, Black	BHGL06X
Gate Kit, 10"W, Black	BHGL10X
Gate Kit, 12"W, Black	BHGL12X
Retention Gate (6) 3 5/8"W, Black	BHGR03X
Retention Gate (6) 6"W, Black	BHGR06X
Retention Gate (6) 10"W, Black	BHGR10X
Retention Gate (6) 12"W, Black	BHGR12X
Finger Section, 11U, Black	BHFS11U
Rack-Mount Finger Bracket, 11U, Black	BHFB11U
Divider Bar, 3 5/8"W, Black	BHDB03X
Divider Bar, 6"W, Black	BHDB06X
Divider Bar, 10"W, Black	BHDB10X
Divider Bar, 12"W, Black	BHDB12X
Fastener for Vertical Manager (100)	BHPF100
Tie Mount for Vertical Manager (100)	BHSM100
Horizontal Manager with Cover	
19"W x 1RU, Black	BHH191UR
19"W x 2RU, Black	BHH192UR
19"W x 3RU, Black	BHH193UR
19"W x 4RU, Black	BHH194UR
1RU, Rack-Mount, Finger Duct Manager 1.75"H x 3.0"D Deep with Cover	9512-1901
2RU, Rack-Mount, Finger Duct Manager 3.0"H x 3.0"D Deep with Cover	9512-1902N
Transition Channel (Top transition channels are only compatible with knockdown racks)	
Top Transition Channel, 19"W x 6"D x 1.75"H, Black	BHTT196
Top Transition Channel High-Density, 19"W x 6"D x 6"H, Black	BHTH196
Lower Transition Channel, 19"W x 6"D x 1.75"H, Black	BHTL196
Lower Transition Channel Double, 19"W x 6"D x 3.5"H, Black	BHTD196

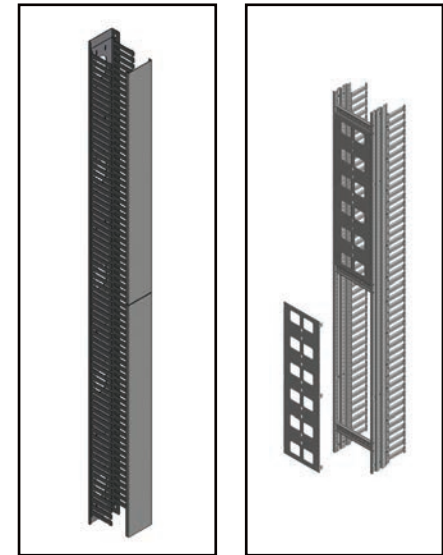

VCMFDR4X4

BHBC10X

(Vertical manager not included)



9512-1902N

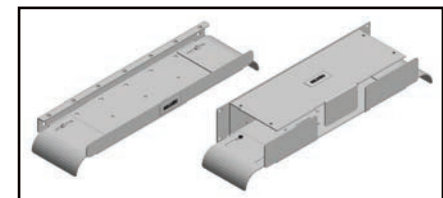

BHTT196 and BHTD196

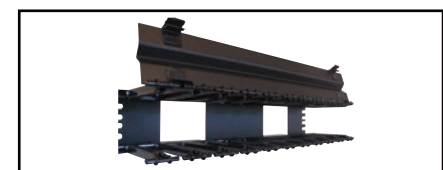

BHH192UC Horizontal Manager

* Value vertical manager is not compatible with BHRR194



XWR and XWB Series – Wall-Mount Racks

Hinged and swing-out for rear access in tight spaces

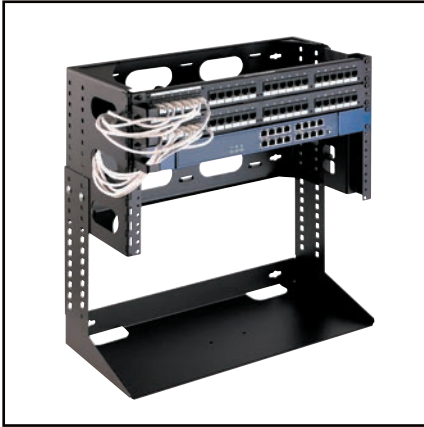

XWR-1219 Wall-Mount Rack in Hinged Style
(shown in closed position with equipment mounted)

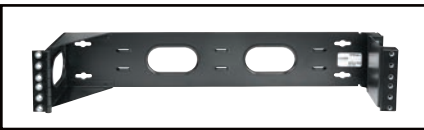

XWB-2U 2RU Wall-Mount Bracket

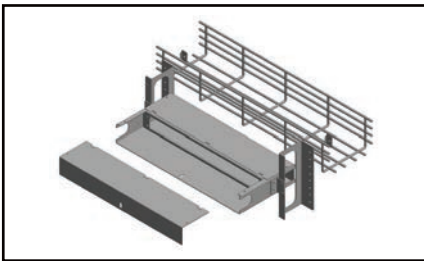

XPE-S0001 1RU rack attach to basket tray

Wall-Mount Racks are available in two styles: hinged and swing-out. The hinged rack is 12" in height and features an adjustable lower shelf (adjusts 2" to 6"). The swing-out rack is available in heights of 36" and 48" with 19" mounting rails. 2RU, 4RU and 6RU Wall-Mount Brackets are also offered for mounting a limited number of components or pieces of equipment.



XWR-3619-18 Swing-Out Style Wall-Mount Rack

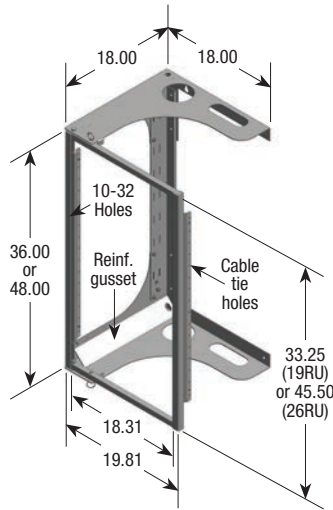

Heavy-Duty XWR Swing-Out Style Wall-Mount Rack

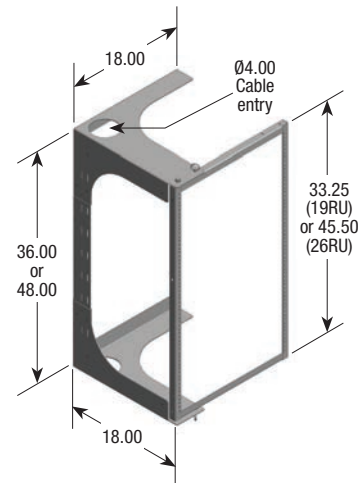

XWR Swing-out Style Wall-Mount Rack

Ordering Information

Description	H	W	D	Weight	Mounting	Load Capacity	Rack Spaces	Belden Part Number
Wall-Mount Racks								
Standard Swing-Out Rack: 36" Wall-Mount Rack with 19" Mounting Rails	36"	19.75"	18"	30 lbs	19"	100 lbs	19RU	XWR-3619-18
Heavy Swing-Out Rack: 36" Wall-Mount Rack with 19" Mounting Rails	36"	19.75"	18"	35 lbs	19"	200 lbs	19RU	XWR-3619-18HD
Standard Swing-Out Rack: 48" Wall-Mount Rack with 19" Mounting Rails	48"	19.75"	18"	39 lbs	19"	100 lbs	26RU	XWR-4819-18
Heavy-Duty Swing-Out Rack: 48" Wall-Mount Rack with 19" Mounting Rails	48"	19.75"	18"	40 lbs	19"	200 lbs	26RU	XWR-4819-18HD
Hinged Rack: 12" Wall-Mount Rack, Hinged, 19" Mounting Rails, Adjustable Lower Shelf 2"–11" to Accommodate Equipment Space	10.9"	19.5"	9.5"	26 lbs	19"	50 lbs	6RU	XWR-1219
Wall-Mount Brackets								
2RU Wall-Mount Bracket, Black	3.5"	19"	8"	4 lbs	19"	50 lbs	2RU	XWB-2U
4RU Wall-Mount Bracket, Black	7.0"	19"	8"	8 lbs	19"	50 lbs	4RU	XWB-4U
6RU Wall-Mount Bracket, Black	10.50"	19"	8"	10 lbs	19"	50 lbs	6RU	XWB-6U
1RU rack, includes basket tray attachment hardware	2.0"	19"	N/A	12 lbs	19"	20 lbs	1RU	XPE-S0001

Faster.
Easier.
Better.



XSW Series – Swing Racks

Free standing swing-out rack used where space is limited

The Swing Rack provides easy access to the rear of rack-mounted equipment in a free standing environment.

It is ideal for applications where space is limited and rear access is essential.

- Rack can be assembled as a left or right hinge and open 90°
- Rack can be positioned as close as 7" from wall
- Equipment up to 18.5" deep can be pivoted
- Cable management allows for cable routing without interference of the swing rack
- Racks can be bolted side-to-side
- Friction lock prevents rack movement while servicing

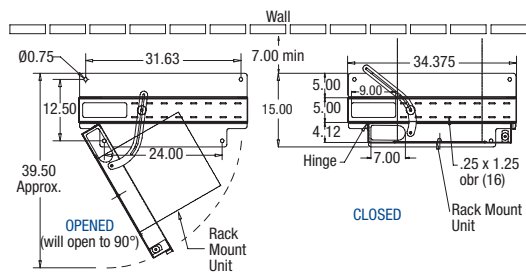

XSW Top View

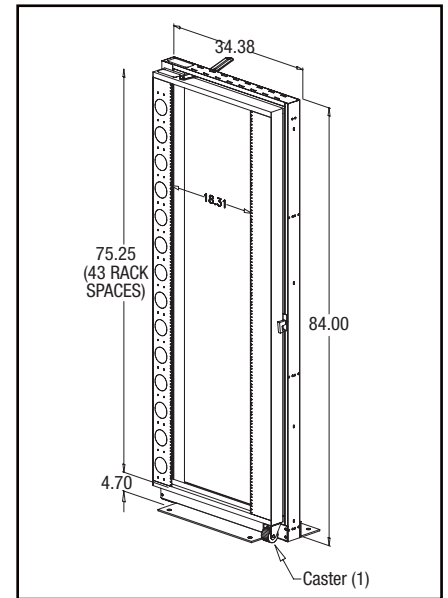
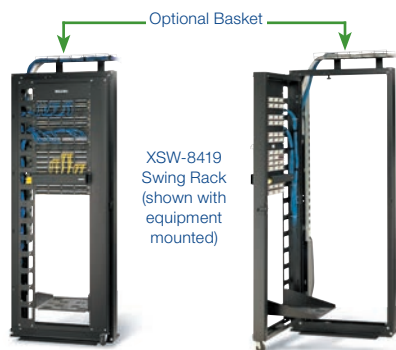

XSW Front View

Ordering Information

Description	Weight	Mounting	Load Capacity	Rack Spaces	Belden Part Number
Swing Racks					
84" Swing-Out Distribution Rack	179 lbs	19"	500 lbs	43RU	XSW-8419
Accessories (Sold Separately)					
Top Mounting Wire Basket	—	—	—	—	XSW-0200
Power Strip Mounting Kit	—	—	—	—	XSW-0100

SECTION TWO

Broadcast Racks and Cabinets

Table of Contents

	Page
Broadcast Racks and Cabinets	48-62
Advantages	49-51
Comparison Chart	51
XSF Series — Slim Frame for Mobile Broadcast/Telecom Applications	52-53
XMF Series — Media Frame for Broadcast Applications	54-56
XME Series — Media Cabinet for Broadcast, AV and Security Applications	57-59
XMER Series — Media Cabinet for Broadcast, AV, Security and Head-End Applications	60-62



Engineered for Performance and Ease of Installation for Broadcast, AV, Security, Head-End and Mobile Telecom Applications

Belden offers four series of **high-quality racks and cabinets** for your unique entertainment, security, head-end and mobile telecom applications.

Belden has designed its broadcast, AV and security rack/cabinet series using the same top-quality and user-friendly principles that go into all of our market-leading solutions. These uncompromisingly strong and well-built structures are combined with component features that optimize cable performance and provide extraordinary flexibility in cable management. These features provide a unique approach to equipment housing and storage needs.

The following pages detail the breadth of our rack/cabinet offering for the entertainment, security and broadcast industries. In addition, Belden offers a complete array of shelves

for 19" mount racks and cabinets, including cantilevered, 4-point mount, sliding and keyboard-type shelves.

Faster.
Easier.
Better.



Advantages of Belden Broadcast Rack and Cabinet Series



Construction

- Welded frame construction for greater strength and structural integrity is standard on all broadcast racks and cabinets

Accessories

- A full complement of accessories will outfit your cabinets with the needed mounting, shelving, work surface and cable management support

Ease of Installation

- EIA rails are marked with rack space increments for ease of equipment mounting

Cable Management

- Numerous top and bottom entry points simplify cabling
- The rounded, steel-formed cable tie bar (Photo A) reduces pressure points
- The multiple attachment points for our Quick Mount System — or nylon ties along the mounting rails, rail supports and cable tie bar (Photos B and C) — provide the utmost flexibility in cable routing and lacing
- The Quick Mount System (Photo D) is comprised of a unique swivel base and base fastener. Velcro ties are easily threaded through the fastener base, allowing the cable bundles to be secured to the rack. The system's swivel base allows for a 90° angle between the cable bundle and the cable tie to allow pressure distribution along the cables

Aesthetics

- Powder-coating process provides a textured black finish for a highly resistant, high-end look that showcases your equipment
- Aesthetics can be tailored to your requirements with a variety of doors, panels and customized silk-screening options

Temperature Control

- Perforated and vented doors, along with a variety of top panel options, provide flexible cooling options

Power Distribution

- A complete line of Belden power distribution units, including rack-mount and vertical-mount options, can be found on [pages 69-78](#)
- Grounding studs allow for integral grounding of cabinets and accessories

Seismic Rating

- XME and XMER Series include NEBS seismic ratings when anchored with optional seismic anchor bracket kit



The cabinet shown here is the XMER Style (Media Cabinet)



Photo A



Photo C



Photo B



Photo D



EIA Rail Kits

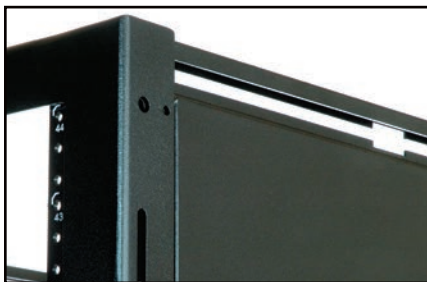

Side Panels

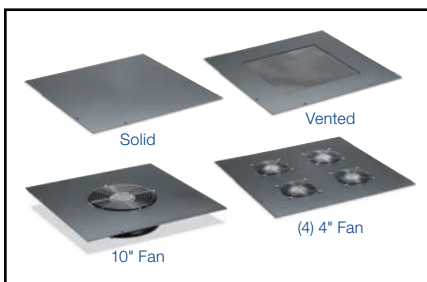

Top Panels



Doors

Advantages of Belden Broadcast Rack and Cabinet Series (continued)

Features and Benefits

EIA Rail Kits

- Rails are made of 12-gauge steel (XSF uses 16-gauge steel)
- Use standard EIA-310 hole-pattern (10-32 or 12-24 tapped holes)
- Fully adjustable depth; designed to be moved without need to remove rail support hardware
- Mounting hardware supplied with rack
- A series of lacing holes along the rails allow for the easy attachment of cables. Holes are also compatible with our Quick Mount fasteners
- RU marking on all rails facilitates equipment mounting
- RU marks are hidden once the equipment is mounted

Side Panels

- The tool-less, surface-mounted side panels are quick and easy to install
- Flush version side panels (available only on the XMF Series) can be installed in between joined racks (heat barrier) or end-of-row units without any additional floorspace requirements
- Panels can be used to transform a rack into a free standing cabinet or to close a row on ganged racks (enhancing the installed look and providing added security)
- Feature lifting handles for easy panel removal

Top Panels

- Solid tops prevent dust from entering the cabinet
- Vented tops allow for convection cooling
- Solid top with 10" (550 CFM) fan for forced hot air evacuation
- Solid top with four 4" (320 CFM), low-noise fans for forced hot air evacuation

Doors

- Rugged and rigid construction
- Doors mounted with lift-off hinges are capable of 180° swing, even when cabinets are ganged
- Door swing is field reversible
- Glass door uses anti-static tempered glass, allowing easy cleaning, rigidity and high-end look
- Perforated door features 63% mesh opening allowing for minimal air resistance for optimized cooling



- High-quality swing latch includes locking mechanism

Side Cable Chase

(Available on XMER Series)

- Adds 4" of valuable cable management space
- Can be mounted to the side of the cabinet and is compatible with the side panels — or can be mounted in between the cabinets to share cable management space

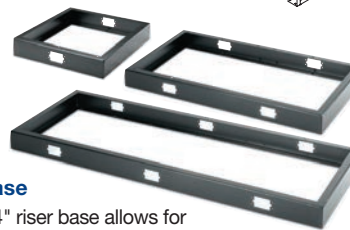
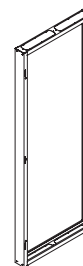

Base

- 4" riser base allows for easy cable routing from rack to rack
- Available in XMF Series: gangable 1-, 2- and 3-bay bases with easy-to-use anchoring holes
- Series of mounting holes allow rack to be secured using common nuts and bolts
- Feature power outlet mounting openings with cover plate
- Includes mounting hardware and grounding stud
- Multi-rack riser bases to meet your specific space requirements (length, height) are available on custom basis

Recessed Caster Base

- Allows for easy positioning of the rack
- Installs directly to bottom flanges of cabinet
- Recessed casters allow the leveling legs to be lowered when the cabinet is in position and raises the casters off the floor
- Includes hardware



Rack-Mount Drawer

- Convenient sliding storage drawers
- 16" deep with lock
- Available in four heights



Front-Mount Work Surface

- Provides a convenient work surface
- 16" deep, single-bay (22") and double-bay (44") width



Faster.
Easier.
Better.



Advantages of Belden Broadcast Rack and Cabinet Series (continued)

Features and Benefits



Vertical Lacing Bar

- 1" wide vertical lacing bar is supplied with mounting hardware
- Mounts to the rail supports; fully adjustable depth
- Series of lacing holes are compatible with Belden Quick Mount fasteners to provide flexibility in cable routing



Vertical Lacing Panel

- Mounts to the rail support
- Fully adjustable depth
- Panel is 3" wide and features multiple lacing points
- Ideal for attaching cable bundle



Power Distribution Units

- Extensive offering
- Includes monitored and IP-based smart PDUs
- Climate monitoring option available



(See pages 69-78)

Grounding Provision

- Belden racks are provisioned with grounding studs, enabling integral grounding of rack and accessories
- The copper vertical ground bar mounts to the rack support
- Fully adjustable depth
- Bar is 3/4" wide x 1/8" thick



Quick Mount Fasteners

- Velcro hook and loop with cable tie mount and fasteners provide a quick, flexible way to route the cable bundle within the rack
- Racks are designed with multiple attachment holes (rails, rail supports) for flexibility, ease of installation and cable integrity protection



Shelves

- Broad selection for 19" mount racks and cabinets
- Cantilevered, 4-point mounted, sliding and keyboard styles

(See page 64)

Belden Broadcast Rack and Cabinet Series Comparison Chart



pg. 52-53



pg. 54-56



pg. 57-59



pg. 60-62

Specifications		XSF	XMF	XME	XMER
Application		Broadcast, Mobile Telecom, Space Optimization	Broadcast	Broadcast, AV, Security	Broadcast, AV, Security, Head End
Style		Rack Gangable	Rack/Cabinet Stand-Alone or Gangable	Cabinet with Fixed Side Panels Stand-Alone or Gangable	Rack/Cabinet Stand-Alone or Gangable
Dimensions:	Height	20.5"-87" (10-48RU)	22.25"-103" (11-57RU)	48.87"-83.87" (24-44RU)	48.87"-83.87" (24-44RU)
	Width	19.19"	22"	22"	22"
	Depth	18", 24" or 30"	24", 30", 36" or 40"	20" or 26.5"	26.5", 31.5" or 36"
Frame Construction (Fully Welded)		11-Gauge Steel	11- and 14-Gauge Steel	16-Gauge Steel	14- and 16-Gauge Steel
Front and Rear Mounting Rails		Yes: Tapped Corner Posts, (fixed front), Adjustable Rear Rails (5/8" increments)	Yes Fully Adjustable	Yes Fully Adjustable	Yes Fully Adjustable
EIA-310 Compliant		Yes (#10-32 or 12-24 tapped)	Yes (#10-32 or 12-24 tapped)	Yes (#10-32 tapped)	Yes (#10-32 tapped)
Door Options:	Reversible Front and Rear Doors	No	Yes	Yes	Yes
	Solid, Perforated or Tempered Glass	—	Solid or Vented	Yes	Yes
Top Options		No	Solid, Vented, Forced Air Fan	Solid, Vented, Forced Air Fan	Solid, Vented, Forced Air Fan
Side Panel Options:	Removable	No	Yes	No: Fixed	Yes
	Panel Style	—	Flush or Surface-Mount	Built-In Frame	Surface-Mount
Shelves (Solid, Vented and Keyboard)		Yes	Yes	Yes	Yes
Caster Base Option		No	Yes	Yes	Yes
Power Strip Mounting Provision		Yes	Yes	Yes	Yes
Cable Management Tie Bar		No	Yes, Optional	No	Yes, Optional



XSF Series – Slim Frames

Light and customizable frames for broadcast trucks and mobile telecom

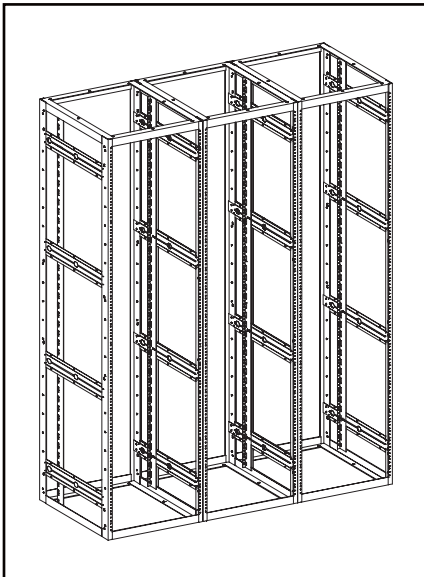

XSF Series Racks in ganged arrangement



Part No. shown here: XSF473010000
(47RU H x 19.19"W x 30"D)

Applications

The ultra-slim XSF frame has been designed to minimize the footprint for installation and use in mobile TV trucks. The narrow 19.19" width will accommodate standard 19" mount equipment. The frames gain strength when ganged together in a series.

Design and Structural Features

- Available in 14 heights and 3 depths
- 11-gauge steel, one-piece formed top and bottom; 11-gauge steel formed vertical corner posts
 - 20.5" (10RU) to 87" (48RU) Height x 19.19" Wide x 18", 24" or 30" Deep
- Optional aluminum, weight-saving version available on request
- Front corner post contains EIA-310 hole pattern: 10-32 or 12-24 tapped
- Rail support channels are 16-gauge steel, riveted and welded in place

Ease of Installation

- One pair, 16-gauge steel EIA rails, moveable front to rear in 0.62" increments
- Each frame is supplied with 10-32 or 12-24 clip nuts for attaching equipment to the rails
- Holes in side flanges of each corner post are available for ganging purposes
- Open bottom with hole pattern to bolt frame to floor; captive grounding studs in bottom sills

Color

- Black durable powder coat

Faster.
Easier.
Better.



Ordering Matrix for XSF Series

Part number example:

XSF282410000

XSF Cabinet, 28RU, 24" depth, with 10-32 tapped frame, no top panel, no rear panel, and no side panels.

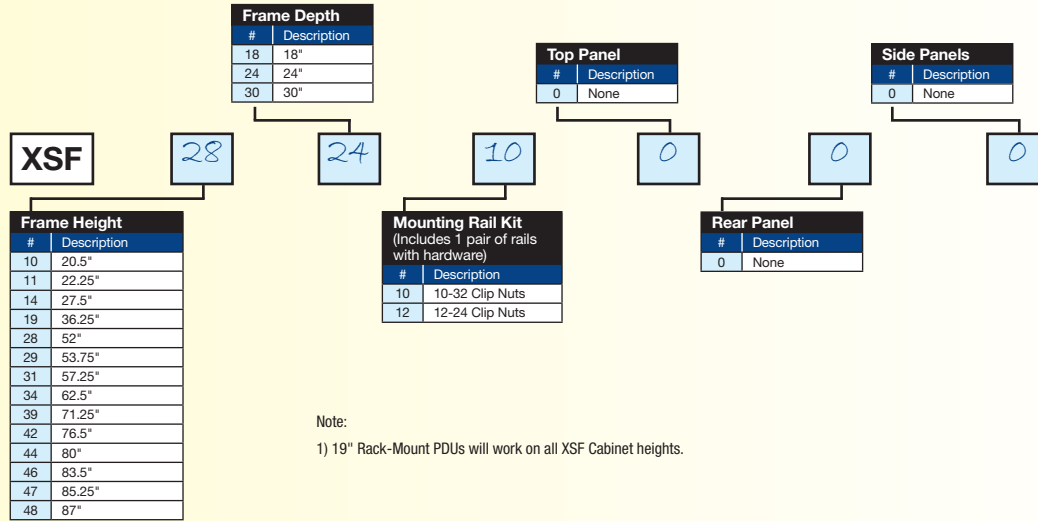

Broadcast Racks and Cabinets

XSF Series – Options and Accessories

EIA Rail Kit – 1 Pair
Includes mounting hardware.

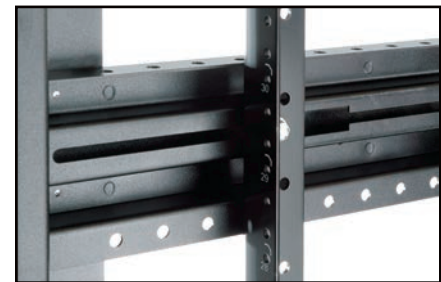
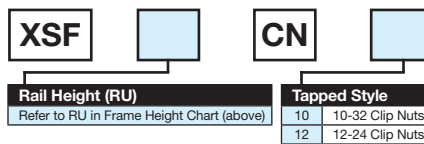

EIA Rail Kit – 1 pair with hardware

Description	Belden Part Number
Other Accessories	
Lacing Accessories	
Quick Mount with Fastener, 10 Pieces	XMFCM



XMF Series - Media Frames

Flexible cable management in a narrow frame for broadcast studios



Part No. shown here: XMF4424100000TB
(44RU H x 22" W x 24" D)



Part No. shown here: XMF4424102140
(44RU H x 22" W x 24" D)

Cable Management

- Numerous lacing points on two surfaces of each rail support
- Cable tie holes span entire length of EIA rail on the attachment flange (spaced at 1.75")
- Unique cable tie bar is made of formed steel to eliminate sharp edges; provides multiple attachment points; features cable bend radius control and lacing holes; factory mounted when tie bar option is selected

Design and Structural Features

- Available in 26 heights and 4 depths for versatility in designing studios or production facilities
- 11-gauge steel corner posts; 11-gauge formed top and bottom members; 14-gauge formed rail supports
 - 22.25" (11RU) to 103" (57RU) Height x 22" Wide x 24", 30", 36" or 40" Deep
- (4) 12-gauge EIA mounting rails (10-32 or 12-24 tapped)
- Frame is provisioned to accept optional front and rear doors, side and top panels
- **Reversible Doors:** Surface-Mount solid, 16-gauge doors or top and bottom vented styles
- **Side Panel:** Solid, 16-gauge flush side panel or 1-piece formed Surface-Mount panel; Surface-Mount panels add 1/2" per side to overall width
- **Top Panel:** Solid, vented or with 10" fan
- **Vertical Spacing Panel:** Easy-to-install; 2.75", 3.66", 4.40" and 5.50" widths; 11RU-57RU heights
- **Riser Base:** 4" height, 1-3 bays; fully welded, gangable; power outlet openings with covers; anchoring holes supplied to ease installation
- **Caster Base:** Recessed; 20", 30", 36" and 40" depths; adds 2.5" to frame height; caster bases install directly to bottom flanges of cabinets; casters are recessed, enabling leveling legs to be lowered when cabinet is in position, allowing the casters to be raised off the floor
- **Rack-Mount Drawers:** 16" deep sliding storage drawers with lock; available in four heights; mount on EIA rails (mounting hardware included); compatible with all 19" mount racks

Ease of Installation

- Frame is provisioned for attaching a tool-less, formed Surface-Mount side panel or a flat, flush panel; flush side can be installed between joined cabinets without any additional floorspace
- Vertical spacing panels add cable management space between racks; includes two panels with attachment studs; panel features lifting handles
- Open top with optional configurable panels
- Open bottom with hole pattern to bolt frame to floor or a raised base; captive grounding studs in bottom sills
- Ganging can be done after equipment is placed in rack

Color

- Black durable powder coat

Static Load Capacity

- 1,000 lbs.

Faster.
Easier.
Better.



Ordering Matrix for XMF Series

Part number example:

XMF443012104TB

XMF Cabinet, 44RU height, 30" depth, with 10-32 tapped frame, vented top panel, solid swing front door, no rear door, set of surface-mount side panels, no power strip, tie bar.

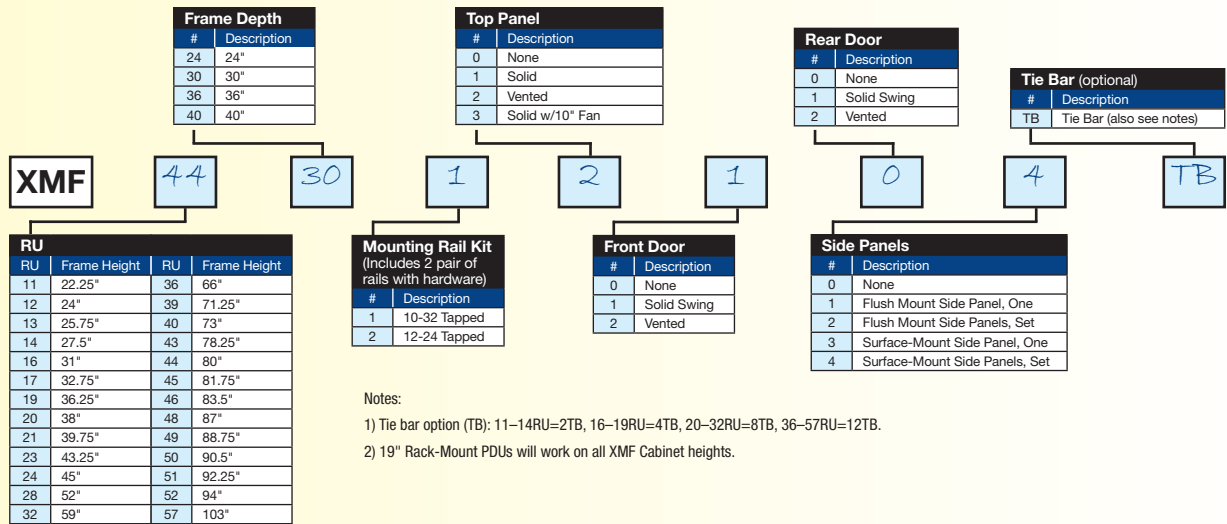

XMF Series – Options and Accessories

Refer to RU and FRAME DEPTH charts (above).

Top Panel Options

XMF22

Panel Depth	
#	Description
24	24"
30	30"
36	36"
40	40"

TP

Panel Style	
#	Description
1	Solid
2	Vented
3	10" Fan

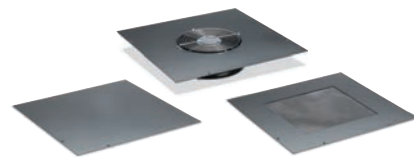

Top Panel Options: Solid, 10" Fan, Vented

Base Options

XMF

B

Bays (4" High)	
#	Description
1	1 Bay
2	2 Bays
3	3 Bays

Base Depth	
#	Description
24	24"
30	30"
36	36"
40	40"



Base Options: 1 Bay, 2 Bays, 3 Bays and Recessed Caster Base

Recessed Caster Base

Use of caster base adds 2.5" to cabinet height.

XMF22

CB

Base Depth	
#	Description
24	24"
30	30"
36	36"
40	40"



XMF Series – Options and Accessories (continued)

Refer to RU and FRAME DEPTH charts (on previous page).



EIA Rail Kits

EIA Rail Kits – 1 Pair

Includes mounting hardware.

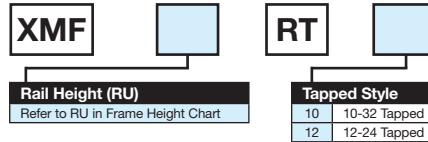

Vertical Spacing Panel

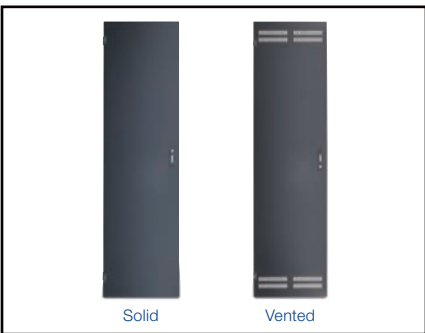
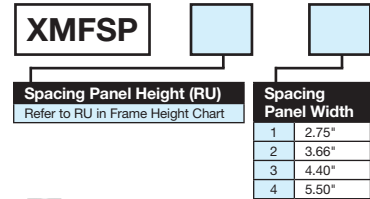

Doors

Door Options

Compatible with cabinet front or rear.

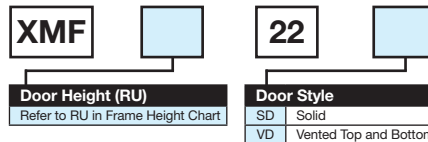

Vertical Lacing Bar



Vertical Ground Bar

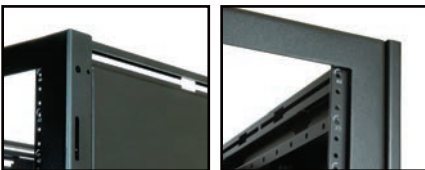
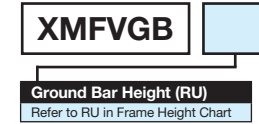

Side Panel Options: Flush Flat Panel (left), Formed Surface-Mount Panel (right)

Side Panel Options

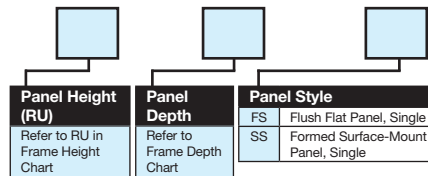

Vertical Lacing Panel

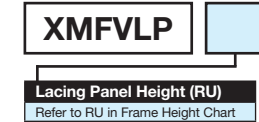

Quick Mount System Components XMFCTM

Description	Belden Part Number
Other Accessories	
Lacing Accesories	
Quick Mount with Fastener, 10 Pcs.	XMFCTM
Velcro 12" Long, Hook and Loop, 10 Pcs./Kit	XCTV12
Velcro 18" Long, Hook and Loop, 10 Pcs./Kit	XCTV18
Velcro 24" Long, Hook and Loop, 10 Pcs./Kit	XCTV24
Seismic Anchor Bracket Kit	
Seismic Anchor Bracket Kit	XMFSB
Adjoining Kits	
Bolt-Together Kit for Frames (incl. hardware)	XMFBK01
Kit for Loaded Rack Application	XMFBK02
Bolt-Together Kit for Bay Bases (incl. hardware)	XMFBK03
Edge Guard Kits (for use with Base Bolt-Together Kit)	
24"D, 30"D (1 base cutout)	XMFEG01
36"D, 40"D (1 base cutout)	XMFEG02

Faster.
Easier.
Better.



XME Series – Media Cabinets

Cost effective and efficient design for broadcast, commercial AV and security applications



Design and Structural Features

- Available in four heights and two depths
- 16-gauge, one-piece formed and vented sides; 16-gauge formed bottom and top
 - 48.87" (24RU) to 83.87" (44RU) Height x 22" Wide x 20" or 26.5" Deep
- Top and bottom EIA rail support channels are an integral part of the top and bottom; formed center rail support channels are spot welded to the sides
- Two 12-gauge EIA mounting rails (10-32 tapped); additional rails can be added (optional)
- Front and side ventilation for convection cooling
- Stand alone or gangable, with integrated side panels
- **Reversible Doors:** Frame is available with optional front and rear solid, glass or perforated Surface-Mount doors
- **Top Panel:** Solid, vented, with 10" fan or (4) 4" fans; depths of 20 and 26.5"
- **Caster Base:** Recessed, depths of 20" and 26.5"; adds 1" to height of frame; casters are recessed, allowing leveling legs to be lowered when cabinet is in position, allowing casters to be raised off the floor
- **Rack-Mount Drawers:** 16" deep sliding storage drawers with lock; available in four heights; mount on EIA rails (mounting hardware included); compatible with all 19" mount racks

Cable Management

- **Rear Access** — Top: three antenna knockouts, each .62" dia. two conduit knockouts, .87" dia. and 1.12" dia. 9" x 2.25" opening with cover plate. Bottom: 4 conduit knockouts, two @ .87" dia., two @ 1.12" dia. 9" x 2.25" opening with cover plate
- **Side Access** — Top: 4" dia. knockout, located toward the rear. Bottom: 4" dia. knockout, located toward the rear. Optional edge guard to protect the cable is available
- **Top Access** — 1", 1.5" and 2" knockouts, located toward the rear of top panel
- Cable tie holes span entire length of EIA rail on the attachment flange (spaced at 1.75")
- Fully open top and bottom facilitate cable routing

Ease of Installation

- Partially open top with optional configurable panels; rear of top contains various electrical knockouts for cable entry
- Open bottom with leveling legs and hole pattern to bolt frame to floor, captive grounding studs in bottom sills
- Ganging can be done after equipment is placed in rack



Part No. shown here: XME442641310
(44RU H x 22" W x 26" D)



Part No. shown here: XME44260001
(44RU H x 22" W x 26" D)

Color

- Black durable powder coat

Static Load Capacity

- 2,000 lbs.

Ordering Matrix for XME Series

Part number example:

XME44203131

XME Cabinet, 44RU height, 20" depth, with 10" fan top panel, glass swing front door, perforated swing rear door, and two fixed vented side panels.

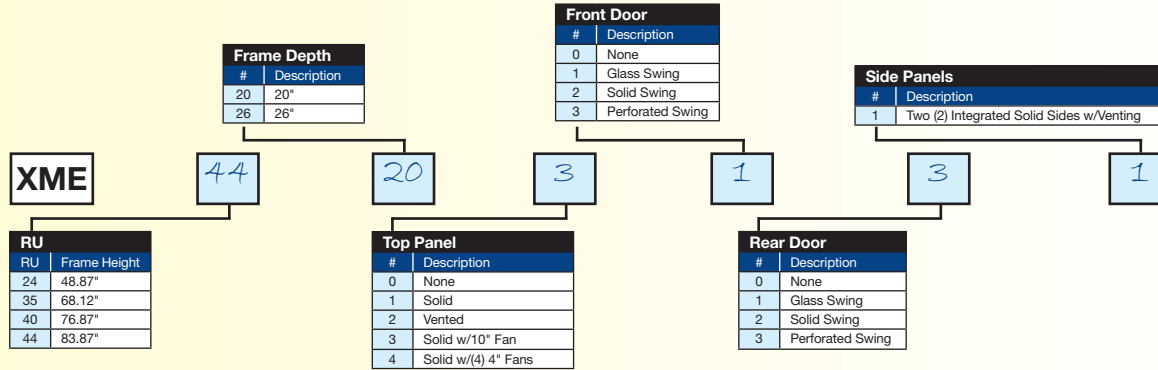

Note:
1) 19" Rack-Mount PDUs will work on all XME Cabinet heights.

XME Series – Options and Accessories

Refer to RU and FRAME DEPTH charts (above) as needed.

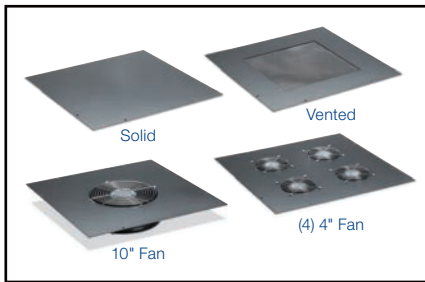

Top Panels

Top Panel Options

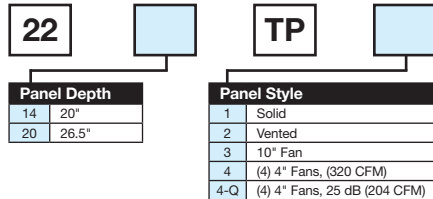

Door Options

Compatible with cabinet front or rear.

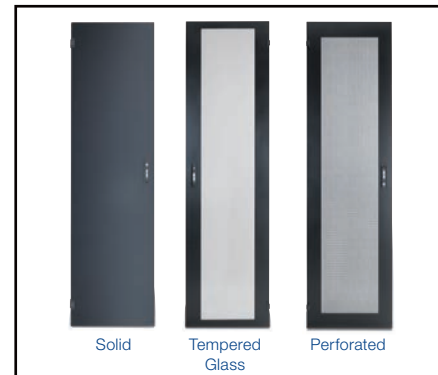
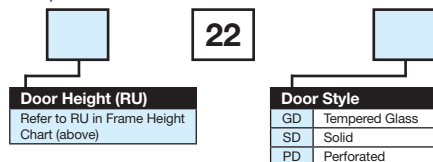

Doors

Faster.
Easier.
Better.



XME Series – Media Cabinet Options and Accessories (continued)



Refer to RU and FRAME DEPTH charts (on previous page).

Front-Mount Work Surface

For standard 19" mounting.

XMEW	
Work Surface	
22	1 Bay, 22"
44	2 Bays, 44"



Vent Kits

Allows for top vent to be blocked to optimize forced air cooling (fanned top).

XME	
Vent Kit	
SVC	Side Vent Cover Kit. Plate to Block Off Vents in Side
FVC	Front Vent Cover Kit. Plate to Block Off Vents in Front



Vent Kits

Vertical Lacing Panel

LP			
Lacing Panel			
24	24RU	40	40RU
35	35RU	44	44RU



EIA Rail Kits – 1 Pair with Hardware

XMER		RT10	
Rail Height (Frame HT)			
24	48"	40	76"
35	67.5"	44	83"



EIA Rail Kits

Recessed Caster Base

22		CB1
Base Depth		
20	20"	
26	26"	

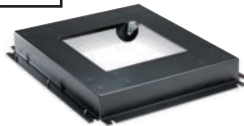

Rack-Mount Drawers

For standard 19" mounting.

RMD			
Drawer Height			
2	2RU	4	4RU
3	3RU	5	5RU



Rack-Mount Drawers

Description	Belden Part Number
Other Accessories	
Lacing Accesories	
Quick Mount with Fastener, 10 Pcs.	XMFACTM
Velcro 12" Long, Hook and Loop, 10 Pcs./Kit	XCTV12
Velcro 18" Long, Hook and Loop, 10 Pcs./Kit	XCTV18
Velcro 24" Long, Hook and Loop, 10 Pcs./Kit	XCTV24
Rack-Mount Lacing Bar	
Rack-Mount Lacing Bar	9512-1903
Top Mounted Ladder Rack Support	
Top-Mounted Ladder Rack Support	XMELM
Adjoining Kit	
(4) 1/4" Whiz Bolt and Whiz Nuts	XMEBK01
Grounding Kit	
Straps and 1/4" Wing Nuts	XMEGK01
Edge Guard Kits	
Edge Guard Kit	XMEEG01
Seismic Anchor Bracket Kit	
Seismic Anchor Bracket Kit	XMERSB



Quick Mount Swivel Base Fastener XMFACTM



Part No. shown: XMER44310000
(44RU H x 22" W x 31.5" D)



Part No. shown: XMER4431320
(44RU H x 22" W x 31.5" D)

26.5", 31.5",
or 36"

22"

48.87"
83.87"

Ease of Installation

- Open top with optional configurable panels
- Open bottom with leveling legs and hole pattern to bolt frame to floor; captive grounding studs in bottom sills
- Ganging can be done after equipment is placed in rack

XMER Series - Media Cabinets

Flexible and economical design for broadcast, commercial AV, security and head-end applications

Design and Structural Features

- Available in four heights and three depths; taller units (48RU, 50RU and 52RU) available on demand
- 14-gauge, one-piece formed top and bottom; 16-gauge formed vertical corner posts
 - 48.87" (24RU) to 83.87" (44RU) Height x 22" Wide x 26.5", 31.5" or 36" Deep
- EIA rail support is integral part of the top and bottom with spot-welded inner support channel
- Middle rail support channels are spot-welded construction of two 16-gauge formed rail channels, creating .12" thick support channels per side
- (4) 12-gauge EIA mounting rails (10-32 tapped)
- **Reversible Doors:** Frame available with optional front and rear solid, glass or perforated surface-mount doors
- **Side Panels:** Surface-Mount removable side panels, adds 5/8" to overall width
- **Top Panel:** Solid, vented, with 10" fan or (4) 4" fans; depths of 26.5", 31.5" and 36"
- **Side Cable Chase:** 4" wide chase for added cable management; can be mounted between cabinets or used as side unit; will accept a side panel (44RU cabinets only)
- **Caster Base:** Recessed, depths of 26.5", 31.5" and 36"; adds 1" to frame height. Caster bases install directly to bottom flanges of cabinets; casters are recessed, allowing leveling legs to be lowered when cabinet is in position, and casters to be raised off floor

Cable Management

- **Rear Access** — Top: three antenna knockouts, each 0.62" dia. two conduit knockouts, 0.87" dia. and 1.12" dia. 9" x 2.25" opening with cover plate; Bottom: four conduit knockouts, two @ 0.87" dia., two @ 1.12" dia. 9" x 2.25" opening with cover plate
- **Side Access** — Top: 4" dia. knockout, located toward rear; Bottom: 4" dia. knockout, located toward rear; optional edge guard to protect the cable available
- **Top Access** — 1", 1.5" and 2" knockouts, located toward rear of top panel
- Lacing points on two surfaces of each rail support facilitate cable management
- Cable tie holes span entire length of EIA rail on attachment flange (spaced at 1.75")
- Cable tie bar made of formed steel, eliminates sharp edges; provides multiple attachment points; features cable bend radius control and lacing holes; factory mounted when tie bar option is selected

Static Load Capacity

- 2,000 lbs.

Faster.
Easier.
Better.



Ordering Matrix for XMER Series

Part number example:

XMER40362232

XMER Cabinet, 40RU height, 36" depth, with vented top panel, solid swing front door, perforated swing rear door, and two solid side panels.

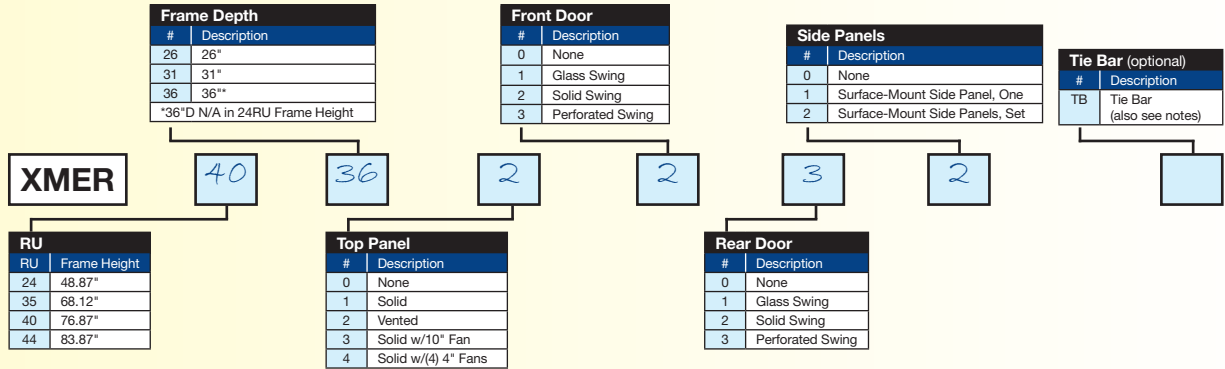

Notes:

- 1) Tie bar option (TB) 24RU=8TB, 35-40-44RU=12TB.
- 2) 19" Rack-Mount PDUs will work on all XMER Cabinet heights.

Broadcast Racks and Cabinets

XMER Series – Options and Accessories

Refer to RU and FRAME DEPTH charts (above).

Top Panel Options

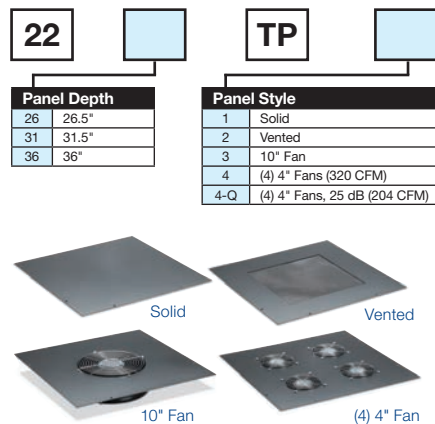

Door Options

Compatible with cabinet front or rear.

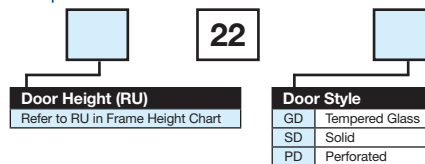

Side Panel Options

Solid removable (single).

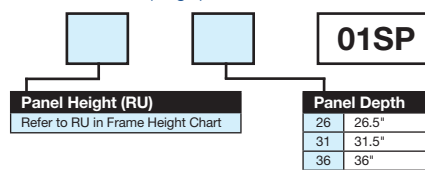

Doors



XMER Series – Options and Accessories (continued)

Refer to RU and FRAME DEPTH charts (on previous page).



EIA Rail Kits

EIA Rail Kits – 1 Pair with Hardware



Rail Height (Frame HT)			
24	48"	40	76"
35	67.5"	44	83"



Side Cable Chase (4" Wide)



Chase Depth	
26	26.5" (RU44)
31	31.5" (RU44)
36	36" (RU44)



Rack-Mount Drawers

Rack-Mount Drawers For standard 19" mounting.



Drawer Height			
2	2RU	4	4RU
3	3RU	5	5RU



Vertical Lacing Panel



Lacing Panel			
24	24RU	40	40RU
35	35RU	44	44RU



Recessed Caster Base

Recessed Caster Base



Base Depth	
26	26"
31	31"
36	36"



Front-Mount Work Surface For standard 19" mounting.



Work Surface	
22	1 Bay, 22"
44	2 Bays, 44"

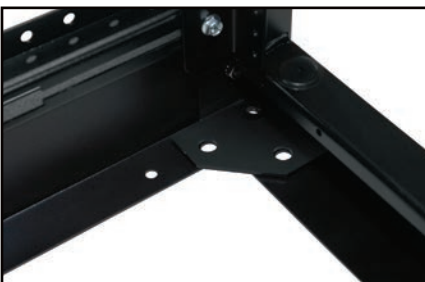

Seismic Anchor Bracket Kit

Description	Belden Part Number
-------------	--------------------

Other Accessories

Lacing Accessories

Quick Mount with Fastener, 10 Pcs.	XMFACTM
Velcro 12" Long, Hook and Loop, 10 Pcs./Kit	XCTV12
Velcro 18" Long, Hook and Loop, 10 Pcs./Kit	XCTV18
Velcro 24" Long, Hook and Loop, 10 Pcs./Kit	XCTV24

Rack-Mount Lacing Bar

Rack-Mount Lacing Bar	9512-1903
-----------------------	-----------

Top-Mounted Ladder Rack Support

Top-Mounted Ladder Rack Support	XMELM
---------------------------------	-------

Adjoining Kit

(4) 1/4" Whiz Bolt and Whiz Nuts	XMEBK01
----------------------------------	---------

Grounding Kit

Straps and 1/4" Wing Nuts	XMEGK01
---------------------------	---------

Seismic Anchor Bracket Kit

Seismic Anchor Bracket Kit	XMERSB
----------------------------	--------



SECTION THREE

Components and Accessories

Table of Contents

Page

Components and Accessories

63-68

Cabinet Shelves	64
Horizontal Cable Management	65
Light Kits	66
Filler Panels	65
Grounding and Bonding	67
Mounting and Adjoining Hardware	67
Cabinet Access Systems	68



Large Selection of Rack and Cabinet Accessories to Meet Equipment Mounting, Cable Management, Grounding/Bonding and Access Control Challenges

Components and accessories designed for seamless compatibility with Belden racks and cabinets products.

- Cantilevered and 4-point mount shelf mounting options for non-rack mount components
- Organize and manage patch cords and cables with horizontal managers available in multiple sizes and capacities
- Optimize air separation for improved availability with solid and brushed filler panels
- Ensure installation security and electrical conformance with bonding and grounding products
- Meet active equipment mounting requirements with multiple mounting hardware products
- Access control for cabinets protects your physical assets and data

Remotely manage server access

while maintaining an indisputable audit trail with Belden Cabinet Access Systems.

Cabinet Shelves 19" Shelves

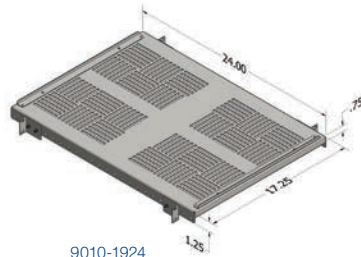

9010-1924

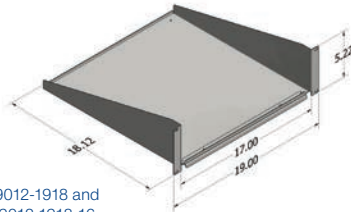

9012-1918 and
9012-1918-16

Features

- Compatible with 19" mount racks and cabinets (23" mount option available on request)
- Available in depths of 12" to 36" cantilevered or 4-point mount types
- Shelves include mounting hardware
- Load ratings range from 25 lbs to 200 lbs
- Standard shelf color is black (other colors are available on custom basis for volume orders)

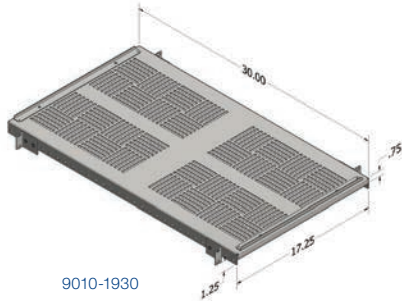

9010-1930

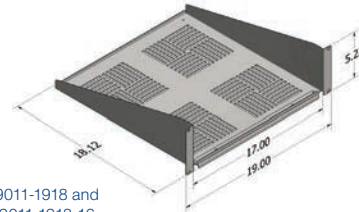

9011-1918 and
9011-1918-16

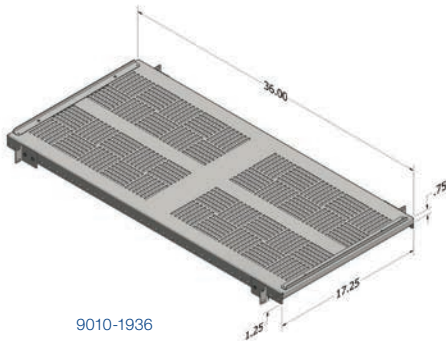

9010-1936

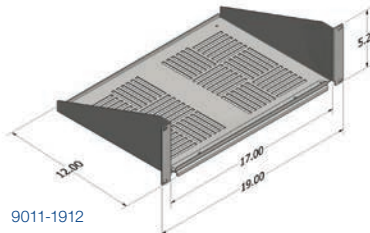

9011-1912

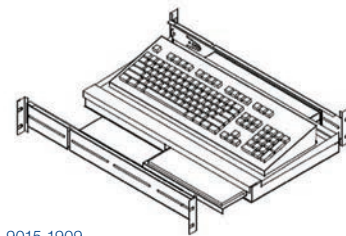

9015-1909

Technical Specifications

Description	Depth*	Load Rating	Belden Part Number
19" Heavy-Duty Adjustable Shelf (Vented), 4-Point Mounting	24"	150 lbs	9010-1924
19" Heavy Duty Adjustable Shelf (Vented), 4-Point Mounting	30"	150 lbs	9010-1930
19" Heavy Duty Adjustable Shelf (Vented), 4-Point Mounting	36"	150 lbs	9010-1936
19" Flush Mount Cantilevered Shelf (Vented) – Compatible with 27.5" Deep Wall-Mount Cabinets	12"	50 lbs	9011-1912
19" Flush Mount Cantilevered Shelf (Vented)	18"	50 lbs	9011-1918
19" Flush Mount Cantilevered Shelf (Vented)	18"	25 lbs	9011-1918-16
19" Flush Mount Cantilevered Shelf (Solid)	18"	50 lbs	9012-1918
19" Flush Mount Cantilevered Shelf (Solid)	18"	25 lbs	9012-1918-16
19" Heavy-Duty Sliding Adjustable Shelf (Vented), 4-Point Mounting	24"	100 lbs	9013-1924
19" Sliding Rotating Keyboard Shelf	N/A	N/A	9015-1909

Note:
*Compatibility with cabinet frame size to be validated when selecting shelf depth.

Faster.
Easier.
Better.



Horizontal Cable Management

Application

Horizontal managers allow routing of copper and fiber cables/patch cords in racks and cabinets while helping to maintain proper bend radius and organize array for ease of moves, adds and changes.

Features include:

- 1RU to 4RU height
- 19" mount includes mounting hardware
- Compatible with racks and cabinets
- Selection of ring, finger and cable tie bar style horizontal managers
- Standard color is black (other colors available on volume orders)



Top: 9512-1901, Bottom: 9512-1902



9510-1901

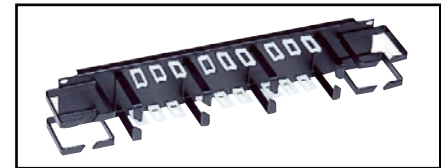

9511-1902



BHH192UFR

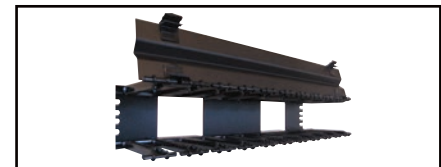

BHH192UC Horizontal Manager

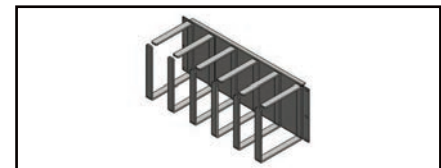

9511-1904-01

Horizontal Managers

Description	RU	Manager Cross Section	Belden Part Number
Horizontal Manager with Saddle Rings	1RU	1.65"H x 3"D	9510-1901
Horizontal Manager with Saddle Rings	2RU	3"H x 3"D	9511-1902
Horizontal Manager with Finger Stock and Cover	1RU	1.5"H x 2"D	9512-1901
Horizontal Manager with Finger Stock and Cover	2RU	3"H x 3"D	9512-1902N
Horizontal Manager with Finger Stock and Cover, Front & Rear	2RU	3"H x 3"D Front/Rear	9512-1902-FR
Horizontal Manager with Molded Fingers and Hinging Cover, Enclosure Application	1RU	1.75"H x 5.66"D	BHH191UC
Horizontal Manager with Molded Fingers and Hinging Cover, Enclosure Application	2RU	3.5"H x 5.66"D	BHH192UC
Horizontal Manager with Molded Fingers and Hinging Cover, Enclosure Application	3RU	5.25" x 5.66"D	BHH193UC
Horizontal Manager with Molded Fingers and Hinging Cover, Enclosure Application	4RU	7" x 5.66"D	BHH194UC
Horizontal Manager with Molded Fingers and Hinging Cover, Open Rack Application	1RU	1.75"H x 7.22"D	BHH191UR
Horizontal Manager with Molded Fingers and Hinging Cover, Open Rack Application	2RU	3.5"H x 7.22"D	BHH192UR
Horizontal Manager with Molded Fingers and Hinging Cover, Open Rack Application	3RU	5.25"H x 7.22"D	BHH193UR
Horizontal Manager with Molded Fingers and Hinging Cover, Open Rack Application	4RU	7"H x 7.22"D	BHH194UR
Horizontal Manager with Molded Fingers and Hinging Covers, Open Rack Application, Front and Rear Cable Management	1RU	1.75"H x 12.25"D	BHH191UFR
Horizontal Manager with Molded Fingers and Hinging Covers, Open Rack Application, Front and Rear Cable Management	2RU	3.5"H x 12.25"D	BHH192UFR
Horizontal Cable Tie Bar with 1.5" Deep Offset	1RU	N/A	HCB-1932-1.5-01
Horizontal Cable Tie Bar with 2.5" Deep Offset	2RU	N/A	HCB-1932-2.5-01
Horizontal Ring Style Manager, High Capacity, Open Rack Application	2RU	3.5"H x 6.8"D	9511-1902-01
Horizontal Ring Style Manager, High Capacity, Open Rack Application	3RU	5.25"H x 6.8"D	9511-1903-01
Horizontal Ring Style Manager, High Capacity, Open Rack Application	4RU	6.9"H x 6.8"D	9511-1904-01

Light Kits



9420-1905

Construction

- Light Kits are compatible with all 19" mount racks or cabinets
- Uses one rack unit
- Includes 120V AC adapter and mounting hardware

Options

Description	Belden Part Number
Dual Adjustable 5W Halogen Lights & Dimmer, UL Listed	9420-1905
Single Adjustable 5W Halogen Light & Dimmer, UL Listed	9420-1906



Steel Filler Panels

Filler Panels

Application

- Filler Panels allow blocking of unused rack units (RUs) for optimized airflow and separation between cold supply air and hot return air
- Best practices in data centers include blanking of all unused rack units
- Filler Panels are compatible with 19" mount racks and cabinets



Plastic Filler Panel

Description	Color	Belden Part Number
-------------	-------	--------------------

Options

Filler Panels, Steel (includes Mounting Hardware)		
1RU Solid Filler Panel	Black/CO White	9910-0100-01/-02
2RU Solid Filler Panel	Black/CO White	9911-0200-01/-02
2RU Solid Filler Panel with Belden Logo Silk Screen	Black	9911-0201-01
3RU Solid Filler Panel	Black/CO White	9912-0300-01/-02
4RU Solid Filler Panel	Black/CO White	9913-0400-01/-02
8RU Solid Filler Panel	Black/CO White	9914-0800-01/02

Filler Panels, Plastic Tool-Less		
1RU Solid Filler Panel (fits 10-32, 12-24 and square holes rails)	Black/CO White	9910-0100PL-01/-02
2RU Solid Filler Panel (fits 10-32, 12-24 and square holes rails)	Black/CO White	9911-0200PL-01/-02

Filler Panels with Brush Pass Through (includes Mounting Hardware)		
1RU Filler Panel with Brush (open ended)	Black/CO White	XFPWB1U101/02
2RU Filler Panel with Brush (open ended)	Black/CO White	XFPWB2U101/02
3RU Filler Panel with Brush (open ended)	Black/CO White	XFPWB3U101/02
4RU Filler Panel with Brush (open ended)	Black/CO White	XFPWB4U101/02

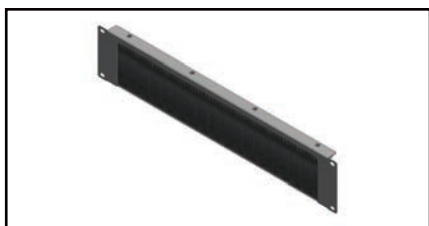

XFPWB2U101

Brushed filler panel allows routing of cable from front to rear while providing airflow separation. Panel is open ended, allowing mounting without having to unplug cables.

XCS Stand-Off

Application

Belden XCS-series 19" rack-mount cable stand-offs provide horizontal cable lacing provisions while keeping the cabling distanced from equipment installed in a rack or cabinet.



Description	Belden Part Number
19" Rack-Mount Cable Standoff with Multiple Obrounds for Lacing, No Offset, Black	XCS-00-01
19" Rack-Mount Cable Standoff with Multiple Obrounds for Lacing, 2" Offset, Black	XCS-02-01
19" Rack-Mount Cable Standoff with Multiple Obrounds for Lacing, 4" Offset, Black	XCS-04-01
19" Rack-Mount Cable Standoff with Multiple Obrounds for Lacing, 5" Offset, Black	XCS-05-01
19" Rack-Mount Cable Standoff with Multiple Obrounds for Lacing, 6" Offset, Black	XCS-06-01
19" Rack-Mount Cable Standoff with Multiple Obrounds for Lacing, 8" Offset, Black	XCS-08-01

Faster.
Easier.
Better.



Grounding and Bonding

Options

Description	Belden Part Number
19" Horizontal Isolated Copper Ground Bar, .25" Thickness x 1" W, Tapped 10-32	9714-0190
Grounding/Bonding Strap Kits	
Bonding Strap Kit (11" strap with hardware)	XBS-11-0001-KIT
Bonding Strap Kit (18" strap with hardware)	XBS-18-0001-KIT
Grounding Lug Kit (Ground Lug and 1/4-20 Kep Nut)	20128-KIT

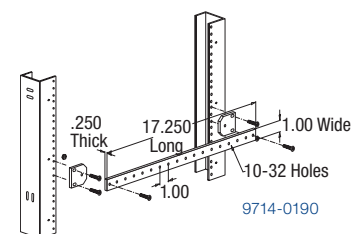

19" mount grounding bar is 0.25" thick x 1" wide, with #10-32 tapped holes; isolating mounts with hardware are included.

Notes:

Bonding strap kit is included with cabinet doors, sides and top panels.
Grounding lug kit is for use with rack and cabinet welded ground studs.

Mounting Hardware

Application

Included adjoining hardware for ganging of racks and cabinets, plus a variety of bolts, screws and nuts for mounting active and passive networking devices into racks and cabinets.

Description	Quantity/Package	Belden Part Number
10-32 Hardware		
10-32 Mounting Screws	50	8911-0100
10-32 Cage Nuts (for use with square hole rails)	50	8915-0100
10-32 Cage Nuts (for use with square hole rails)	20	8915-0220
10-32 Clip Nuts	20	8915-0320
12-24 Hardware		
12-24 Mounting Screws	50	8917-0100
12-24 Cage Nuts (for use with square hole rails)	50	8917-0220
12-24 Clip Nuts	20	8917-0320
M6 Hardware		
M6 Cage Nut (for use with square hole rails)	50	8913-0100
M6 Cage Nut (for use with square hole rails)	20	8913-0220
M6 Clip Nut	20	8913-0320
M6 x 16 mm Mounting Screw	50	8914-0100
Cable Ties		
Velcro Cable Ties, 8"L x 0.5"W, 25 per Roll	25	AX100783
Velcro Cable Ties, 12"L x 0.5"W, 25 per Roll	25	AX100784
12" Fiber Optic Cable Manager	1	AX102516
24" Fiber Optic Cable Manager	1	AX102517
Quick Mount Velcro Saddle with Fastener	10	XMFCTM



AX102516 Cable Slack Management Ring - 12" diameter

Adjoining Hardware

Description	Cabinet Series	Belden Part Number
Cabinet Adjoining Kit (4) 5/16-18 Hex Head Bolt; (4) 5/16-18 Hex Nut; (8) 5/16 Flat Washer)	XHN, XHM, XHS, XHMS, XHSS	8910-0100
Bolt-Together Kit for XSF Frames (incl. hardware)	XSF	XSFBK01
Adjoining Kit (4) 1/4-20 x 5/8 Carriage Bolt; (4) 5/16 External Tooth Lock Washer; (4) Whizlock Nuts	XMF	XMFBK01
Loaded Rack Application Bolt Kit (4) 12-24 x 1 3/4 Screw; (8) External Tooth Washer; (4) 12-24 Hex Nuts; (4) .5 x .125"W Tubing Nylon	XMF	XMFBK02
Adjoining Kit (4) 1/4-20 x 5/8 Whizlock Bolt; (4) 1/4-20 Whizlock Nut	XME, XMER	XMEBK01
Joining Kit (4) 5/16 x 1 Bolt, (8) 5/16 Washers, (4) 5/16 Nuts	—	XBK01

Note:

Adjoining hardware is included with the cabinets.

Cabinet Access Systems

Application

Physical asset protection/access is key to IT operations, such as data centers, enterprise and remote computing locations. Belden cabinets can be equipped with a variety of locking handles, including state-of-the-art cabinet access control and management solutions, allowing conformance to privacy rules and regulations (PCI DSS, HIPAA, FISMA and more).

Features

- Centralized administration of up to thousands of units
- Real-time monitoring and alerts
- Indisputable audit trails
- Cabinets or row-pod-level access
- Flexibility to choose between fingerprint or RFID card access

Standalone cabinet access systems are for smaller or distributed installations. Each cabinet has a dedicated controller and biometric (BioLock) or card reader (CardLock) for user authentication.

In a networked cabinet access system, a central controller distributes control signals and power to up to 32 cabinets when authenticating at the cabinet level and 31 cabinets when authenticating at the end of row. For cabinet-level authentication, choose between fingerprint (BioLock) or RFID card (CardLock). For end-of-row authentication, the user enters the cabinet door they are attempting to access, then uses any combination of PIN, RFID card and fingerprint to authenticate.

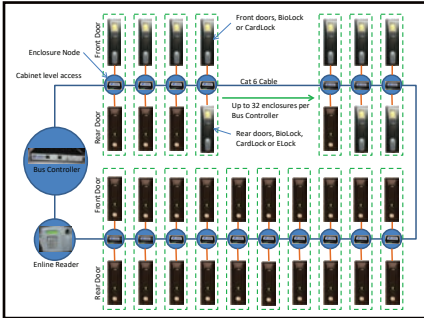

Access control with schematic



BEH-CTRL BUS Controller



BEH-Nx Cabinet Node



BEH-Sx Sentry



BEH-EN BUS Online Reader w/PIN and Fingerprint



ELock, BioLock, DualLock, ProxLock, MulticardLock and KeypadLock/CodeLock

Description	Belden Part Number
Smart Lock/Access System	
BUS Controller	BEH-CTRL
End of Row Reader	
Online reader w/PIN and fingerprint	BEH-EN
Online reader w/PIN, fingerprint and LF (125 KHz Prox) RFID	BEH-ENLF
Online reader w/PIN, fingerprint and HF (HID iClass 13.56 MHz)	BEH-ENHF
Online reader w/PIN, fingerprint and HF (HID iClass 13.56 MHz) and LF (125 KHz Prox) RFID	BEH-ENHFLF
Bus Node Kits - Networked Application (Multiple Cabinets)	
Cabinet Node w/ 1 BioLock, 1 ELock, 2 Door Position Sensors	BEH-NBE2S-S
Cabinet Node w/ 2 BioLocks, 2 Door Position Sensors	BEH-NBB2S-S
Cabinet Node w/ 1 HF MULTICARDLOCK and 1 ELock, 2 Door Position Sensors	BEH-NMHE2S-S
Cabinet Node w/ 2 HF MULTICARDLOCKS, 2 Door Position Sensors	BEH-NMHMH2S-S
Cabinet Node w/ 2 ELocks, 2 Door Position Sensors	BEH-NEE2S-S
Cabinet Node w/ 1 KeypadLock and 1 ELock, 2 Door Position Sensors	BEH-NKE2S-S
Cabinet Node w/ 2 KeypadLocks, 2 Door Position Sensors	BEH-NKK2S-S
Cabinet Node w/ 1 HF CodeLock and 1 ELock, 2 Door Position Sensors	BEH-NCHE2S-S
Cabinet Node w/ 2 HF CodeLocks, 2 Door Position Sensors	BEH-NCHCH2S-S
Cabinet Node w/ 1 HF/LF CodeLock and 1 ELock, 2 Door Position Sensors	BEH-NCHLE2S-S
Cabinet Node w/ 2 HF/LF CodeLocks, 2 Door Position Sensors	BEH-NCHLCHL2S-S
Sentry Kits - Cabinet (Stand-Alone) Applications	
Sentry w/ 1 BioLock, 1 ELock, 2 Door Position Sensors	BEH-SBE2S-S
Sentry w/ 2 BioLocks, 2 Door Position Sensors	BEH-SBB2S-S
Sentry w/ 1 HF MULTICARDLOCK and 1 ELock Swing Handle, 2 Door Position Sensors	BEH-SMHE2S-S
Sentry w/ 2 HF MULTICARDLOCKS, 2 Door Position Sensors	BEH-SMHMH2S-S
Sentry w/ 1 KeypadLock and 1 ELock, 2 Door Position Sensors	BEH-SKE2S-S
Sentry w/ 2 KeypadLock, 2 Door Position Sensors	BEH-SKK2S-S
Sentry w/ 1 HF CodeLock and 1 ELock, 2 Door Position Sensors	BEH-SCHE2S-S
Sentry w/ 2 HF CodeLocks, 2 Door Position Sensors	BEH-SCHCH2S-S
Sentry w/ 1 HF/LF CodeLock and 1 ELock, 2 Door Position Sensors	BEH-SCHLE2S-S
Sentry w/ 2 HF/LF CodeLocks, 2 Door Position Sensors	BEH-SCHLCHL2S-S
Auxiliary Power Supply for Sentry	BEH-SAPS
Software - Access Interface and Management	
DAS server/client package for connection up to 10 units, includes enrollment scanner	BEH-SW10
DAS server/client package for connection up to 20 units, includes enrollment scanner	BEH-SW20
DAS server/client package for connection to 50 units, includes enrollment scanner	BEH-SW50
DAS server/client package for connection to 100 units, includes enrollment scanner	BEH-SW100
DAS server/client package for connection to 250 units, includes enrollment scanner	BEH-SW250

Note:
Includes door switch(es) and 14' of Cat 6 cables.



SECTION FOUR

Power Distribution & Climate Monitoring

Table of Contents

Page

Power Distribution & Climate Monitoring	69-78
Cabinet Power Distribution Units (PDUs)	70-71
Single-Phase Basic/Smart PDUs	72
3-Phase Basic/Smart PDUs	73
Single- and 3-Phase Switched PDUs	74
PDU Accessories — Mounting, Cord Management and Cord Set	75
PDU Configuration Guide	76
Plug and Receptacle Configuration Chart	77
Environmental Monitors and Sensors	78



Precisely distribute, monitor, analyze and manage power distribution in your facility to **maximize processing capacity** and promote power efficiency.

Power Availability, Distribution, Allocation and Monitoring are Critical Data Center and Broadcast Studio Requirements

Belden in-cabinet mounted power distribution units (PDUs) and environmental monitors and sensors are designed from high-quality components to support all your mission-critical applications.

A key component of our data center ready solution (DCRS), Belden PDUs allow configuration of integrated and optimized hosting systems, including fiber/copper connectivity and cabling, cabinets, cable management and airflow management. They are designed to facilitate seamless integration into Belden racks and cabinets, and include multiple mounting options for maximized airflow and cable management in high-density servers or switch hosting applications.

Paired with our extensive line of environmental monitors and sensors, which include alarm thresholds, reporting functionality and a built-in intuitive web interface for remote access, Belden has everything you need to precisely monitor, analyze and log key parameters, enabling you to identify current fluctuations and quickly troubleshoot potential problems.

*Lacing-PDU mounting panels (p. RC-67) are not included with the cabinets or the PDUs and need to be ordered separately. PDUs/panels uses tool-less "button"-style mounting.



Cabinet Power Distribution Units (PDUs)

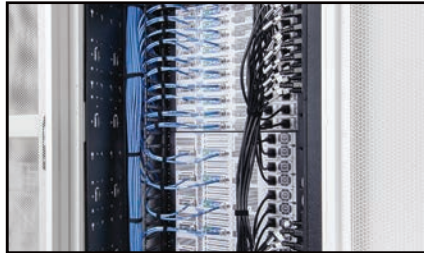

Organized networking and power cable management for proper server airflow



Side-by-side PDU mounting using 7" wide PDU mounting panel (Part No. HVMP024501)



U-Lock Receptacles

Belden PDU Options and Features

- All Belden PDUs are UL and cUL listed 60650
- Select from a wide offering of PDUs designed to meet your specific power requirements; single phase, 3-phase (WYE and Delta configurations)

Power	Amp	Voltage	Phase	Plug
3.3kW	20A	250V	1 Phase	L6-20P or 2P, 3W
5kW	30A	250V	1 Phase	L6-30P or 2P, 3W
11kW	20A	230/400V	3 Phase WYE	L22-20P or 4P, 5W
16.6kW	30A	230/400V	3 Phase WYE	L22-30P or 4P, 5W
1.4kW	15A	125V	1 Phase	5-15P or L5-15P
1.9kW	20A	125V	1 Phase	5-20P or L5-20P
2.8kW	30A	125V	1 Phase	L5-30P
5.7kW	20A	120/208V	3 Phase WYE	L21-20P
8.6kW	30A	120/208V	3 Phase WYE	L21-30P
8.6kW	30A	250V	3 Phase Delta	L15-30P
17.2kW	60A	208V	3 Phase Delta	3P/4W
23kW	80A	208V	3 Phase Delta	Hard Wired
34kW	120A	208V	3 Phase Delta	Hard Wired

- U-Lock IEC C13 and C19 receptacles feature an integrated locking mechanism built within the receptacle housing. The locking mechanism is protected against vibration and external elements that can easily dislodge external locking clips or guides. This self-contained locking mechanism works with any standard IEC plug. Locking receptacles come standard on some units and are available for custom orders.

Faster.
Easier.
Better.



Cabinet Power Distribution Units (PDUs) (continued)



PDU Selection: Basic, with Local Monitoring and Intelligent

- PDU mounted display option for local current or power monitoring, making phase balancing easier (the PDU itself is not phase balancing)

Intelligent PDU Options and Features

- Remote aggregate, circuit or receptacle power monitoring for granular PUE measurement
- Switched (on/off) options allow remote outlet management and equipment reboot with sequential delay features; avoid power interruption due to in-rush current, equipment start up in desired sequence

- Highly secure access with admin, control and view-only accounts
- Intuitive Ethernet-based firmware with email alarm or SNMP trap features prevents downtime with early notification of power threshold breaches
- SNMP (MIB) enabled for compatibility with all leading DCIM packages
- Integrated environmental monitoring capabilities; monitor temperature, airflow, humidity and dew point via optional connected sensors
- Internal memory for up to two week of trending of critical parameters for clear understanding of power allocation and usage



PDU Firmware, Trending Page



PDU Firmware, Alarm Setting Page

Belden PDU Type	Local Display/ Monitoring	Intelligent Remote Monitoring (3)					Outlet Switched (6)
		Current	Power Circuit Level	Environmental Port (4)	Power Outlet Level (5)		
Basic (B)	No	No	No	No	No	No	
Local (L)	Yes	No	No	No	No	No	
Power (P)	Yes (2)	Yes	Yes	Yes	No	No	
Power Outlet (O)	Yes (2)	Yes	Yes	Yes	Yes	No	
Switched (S)	Yes (2)	Yes	Yes	Yes	Optional	Yes	

Notes:

- (1) Local current/amp meter, monitoring at circuit level for multi-circuit PDU.
- (2) Local power meter provides Amps, Volts, Watts, Volt-Amps, kWh and Power Factor.
- (3) Remote functions (IP-based) accessible via web browser.
- (4) Remote IP-based environmental monitoring, (1) port per PDU. Requires external sensor, refer to accessories (p. RC-70) for selection.
- (5) Remote IP-based receptacle level monitoring, Amps, Volts, Watts, kWh.
- (6) Remote IP-based receptacle level switching (on/off) with configurable time delay.



Intelligent PDU Communication and Environmental Monitoring Ports

Power, Cooling and Air-Handling Relations

PDU Nameplate Current Rating (A)	Branch Circuit Rating (A)	Nameplate Volts (V)	Volts Actual Delivered (V)	Phase*	PDU Nominal Power (W)	PDU De-Rated Power (W)	PDU De-Rated Power (kW)	PDU De-Rated Power (BTU/hr)	AC Tons** (BTU/12000)	Air Volume*** (120 CFM* kW)
12	15	125	120	1	1,800	1,440	1.4	4,916	0.41	168
16	20	125	120	1	2,400	1,920	1.9	6,555	0.55	228
24	30	125	120	1	3,600	2,880	2.9	9,832	0.82	348
16	20	250	208	1	4,160	3,328	3.3	11,362	0.95	396
24	30	250	208	1	6,240	4,992	5.0	17,043	1.42	600
35	50	250	208	1	10,400	7,280	7.3	24,854	2.07	876
48	60	250	208	1	12,480	9,984	10.0	34,085	2.84	1,200
16	20	230	230	1	4,600	3,680	3.7	12,564	1.05	444
24	30	230	230	1	6,900	5,520	5.5	18,845	1.57	660
48	60	230	230	1	13,800	11,040	11.0	37,691	3.14	1,320
16	20	120/208	208	3	7,197	5,757	5.8	19,656	1.64	696
24	30	120/208	208	3	10,795	8,636	8.6	29,484	2.46	1,032
35	50	120/208	208	3	17,992	12,594	12.6	42,997	3.58	14,712
48	60	120/208	208	3	21,616	17,293	17.3	58,968	4.91	2,076
80	100	120/208	208	3	36,027	28,821	28.8	98,279	8.19	3,456
100	125	120/208	208	3	45,033	36,027	36.0	122,849	10.24	4,320
120	150	120/208	208	3	54,040	43,232	43.2	147,419	12.28	5,184
16	20	230/400	230	3	13,856	11,085	11.0	37,691	3.14	1,320
24	30	230/400	230	3	20,785	16,628	16.6	56,563	4.71	1,992
*3-Phase power is calculated by multiplying single phase by the square root of 3 or 1.73.										
**Tons of air conditioning required to remove heat from associated IT load.										
***The volume of air that is typically required by the IT equipment for each kW of IT load can typically range from 80 to 140 CFM. 120 CFM was used for calculation.										



Single-Phase Basic/Smart PDUs



Front View 9LF1-101001



Rear View 9LF1-101001



9PH2-241007

UL Listed Single-Phase PDUs

Type: B = Basic; L = Local Monitored

Belden Part #	Type	De-Rated Power (kW)	Amps (A)/ Volts (V)	Plug Type	Total Receptacle	Receptacle Type/Qty	Thermal Circuit Breaker	On-Off Switch	Surge Suppression	Monitoring-Local	Mounting (4)	Dimensions L x W x D (in.)
9BF1-061001	B	1.4	15/120	5-15P	6	5-15R/6	Yes	Yes	No	No	Rack - 19"	17 x 1.72 x 3.75
9BF1-061002	B	1.4	15/120	5-15P	6	5-15R/6	Yes	Yes	Yes	No	Rack - 19"	17 x 1.72 x 3.75
9BF1-081001	B	1.4	15/120	5-15P	8	5-15R/8	Yes	Yes	No	No	Vertical	24 x 1.61 x 1.61
9LF1-101001	L	1.4	15/120	5-15P	10	5-15R/10	Yes	Yes	No	Power	Rack - 19"	17 x 1.72 x 4.5
9BF1-141001	B	1.4	15/120	5-15P	14	5-15R/14	Yes	Yes	Yes	No	Vertical	47.5 x 1.61 x 1.61
9BG2-081001	B	1.9	20/120	L5-20P	8	5-20R/8	Yes	Yes	No	No	Vertical	24 x 1.61 x 1.61
9BG1-101001	B	1.9	20/120	5-20P	10	5-20R/10	Yes	Yes	Yes	No	Rack - 19"	17 x 1.72 x 3.75
9LG1-101001	L	1.9	20/120	5-20P	10	5-20R/10	Yes	No	No	Power	Rack - 19"	17 x 1.72 x 4.5
9BG1-141001	B	1.9	20/120	5-20P	14	5-20R/14	Yes	Yes	No	No	Vertical	47.5 x 1.61 x 1.61
9BG2-141001	B	1.9	20/120	L5-20P	14	5-20R/14	Yes	Yes	No	No	Vertical	47.5 x 1.61 x 1.61
9BG1-141002	B	1.9	20/120	5-20P	14	5-20R/14	Yes	No	Yes	No	Vertical	47.5 x 1.61 x 1.61
9BG2-141002	B	1.9	20/120	L5-20P	14	5-20R/14	Yes	No	Yes	No	Vertical	47.5 x 1.61 x 1.61
9PH2-241007	P	1.9	30/120	L5-30P	24	5-20R/24	No	No	No	Power	Vertical	66.25 x 2 x 2
9PB2-101002	P	5	30/208	L6-30P	10	C-13L/10	Magnetic	Breaker	No	Power	Rack - 19"	17 x 1.72 x 8.5
9PB2-361007	P	5	30/208	L6-30P	36	C-13/30 + C-19/6	Magnetic	Breaker	No	Power	Vertical	66.25 x 2 x 2

Notes:

(1) Standard cord exits from chassis face; top of chassis exit available on request.

(2) Standard PDU chassis color is black, custom color available on request.



Front View 9PG1-101001



Rear View 9PG1-101001

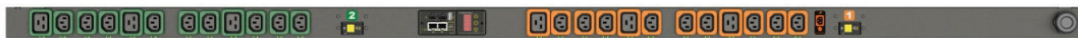

9OB2-241003

UL Listed Single-Phase PDUs

Type: P = Remote Power Monitored; O = Outlet Monitored

Belden Part #	Type	De-Rated Power (kW)	Amps (A)/ Volts (V)	Plug Type	Total Receptacle	Receptacle Type/Qty	Thermal Circuit Breaker	On-Off Switch	Monitoring-Local/Remote	Environmental Monitoring	Mounting (4)	Dimensions L x W x D (in.)
9PG1-101001	P	1.9	20/120	5-20P	10	5-20R/10	No	No	Power/Aggregate	Yes - 1 Port	Rack - 19"	17 x 1.72 x 8.5
9PB2-361005	P	5	30/208	L6-30P	36	C-13/30 + C-19/6	Magnetic	Breaker	Power/Circuit Breaker	Yes - 1 Port	Vertical	66.25 x 2 x 2
9PB2-361009	P	5	30/208	L6-30P	36	C-13L/30 + C-19L/6	Magnetic	Breaker	Power/Circuit Breaker	Yes - 1 Port	Vertical	72 x 2 x 2
9PB2-421003	P	5	30/208	L6-30P	42	C-13/36 + C-19/6	Magnetic	Breaker	Power/Circuit Breaker	Yes - 1 Port	Vertical	70 x 2 x 2
9OB2-241003	O	5	30/208	L6-30P	24	C-13L/18 + C-19L/6	Magnetic	Breaker	Power/Circuit Breaker + Outlet	Yes - 1 Port	Vertical	66.25 x 2 x 2.6

Notes:

(1) Standard cord exits from chassis face; top of chassis exit available on request.

(3) Standard PDU chassis color is black, custom color available on request.

(2) C-13L, L refers to receptacles with locking feature.

(4) These PDUs have no Surge Suppression.

Faster.
Easier.
Better.



3-Phase Basic/Smart PDUs



UL Listed 3-Phase PDUs

Type: B = Basic; P = Power Monitored

Belden Part #	Type	De-Rated Power (kW)	Amps (A) x Phases	Input Volts (V)/ Output Volts (V)	Plug Type	Total Receptacle	Receptacle Type/Qty(s)	Circuit Breaker (Amp/Qty)	Monitoring-Local/Remote	Mounting	Dimensions L x W x D (in.)
9PI2-421004	P	5.7	20 x 3 Ph.	120/208 WYE/208	L21-20P	42	C-13L/36 + C-19L/6	No	Amp (X,Y,Z)/No	Vertical	72 x 2 x 2 Dog House - No
9PJ2-421003	P	8.6	30 x 3 Ph.	120/208 WYE/208	L21-30P	42	C-13/36 + C-19/6	20/3D	Amp (X,Y,Z)/No	Vertical	72 x 2 x 2 Dog House - No
9BJ2-331001	B	8.6	30 x 3 Ph.	120/208 WYE/120 & 208	L21-30P	33	C-13/24 + C-19/3 + 5-20R/6	20/3D	Amp (X,Y,Z)/No	Vertical	66.25 x 2 x 2 Dog House - No
9PC2-301001	P	11	20 x 3 Ph.	230/400 WYE/230	L22-20P	30	C-13L/24 + C-19L/6	No	Amp (X,Y,Z)/No	Vertical	66.25 x 2 x 2 Dog House - No
9PD2-301002	P	16.6	30 x 3 Ph.	230/400 WYE/230	L22-30P	30	C-13L/24 + C-19L/6	20/6D	Amp (X,Y,Z)/No	Vertical	72 x 2 x 2.25 Dog House - No
9PD3-301001	P	16.6	30 x 3 Ph.	230/400 WYE/230	4P, 5W	30	C-13L/24 + C-19L/6	20/6D	Amp (X,Y,Z)/No	Vertical	72 x 2 x 2.25 Dog House - No
9BL3-241002	B	17.3	60 x 3 Ph.	208 Delta/208	3P, 4W	24	C-13L/12 + C-19L/12	20/6	Breaker/No	Vertical	72 x 2.25 x 3.44 Dog House - No

Notes:

- (1) Standard cord exits from chassis face; top of chassis exit available on request.
- (2) C-13L, L refers to receptacles with locking feature.
- (3) Ex: 20/3D, D refers to double pole breakers (20A in this case).
- (4) Standard PDU chassis color is black, custom color available on request.
- (5) These PDUs have no Surge Suppression or On/Off Switch.
- (6) PDU "Dog House" hosts the circuit breaker and protrude from the PDU chassis by 1.44".



UL Listed 3-Phase PDUs

Type: P = Power Monitored; O = Outlet Monitored

Belden Part #	Type	De-Rated Power (kW)	Amps (A) x Phases	Input Volts (V)/ Output Volts (V)	Plug Type	Total Receptacle	Receptacle Type/Qty(s)	Circuit Breaker (Amp/Qty) (4)	Monitoring-Local/Remote	Environ. Monitoring	Dimensions L x W x D (in.)
9PJ2-421001	P	8.6	30 x 3 Ph.	120/208 WYE/208	L21-30P	42	C-13/36 + C-19/6	20/3D	Current/Current	No	72 x 2 x 2 Dog House - No
9OJ2-241005	O	8.6	30 x 3 Ph.	120/208 WYE/208	L21-30P	24	C-13L/18 + C-19L/6	20/3D	Power/X, Y, Z + Outlet	Yes - 1 Port	66.25 x 2 x 2 Dog House - No
9OC2-361001	O	11	20 x 3 Ph.	230/400 WYE/230	L22-20P	36	C-13L/30 + C-19L/6	No	Power/X, Y, Z + Outlet	Yes - 1 Port	66.25 x 2 x 2.6 Dog House - No
9OD3-361001	O	16.6	30 x 3 Ph.	230/400 WYE/230	4P, 5W	36	C-13L/30 + C-19L/6	20/6	Power/X, Y, Z + Outlet	Yes - 1 Port	72 x 2 x 2.6 Dog House - Yes
9PL3-241006	P	17.3	60 x 3 Ph.	208 Delta/208	4P, 4W	24	C-13L/12 + C-19L/12	20/6D	Power/X, Y, Z	Yes - 1 Port	72 x 2.25 x 3.44 Dog House - No

Notes:

- (1) Standard cord exits from chassis face; top of chassis exit available on request.
- (2) C-13L, L refers to receptacles with locking feature.
- (3) Ex: 20/3D, D refers to double pole breakers (20A in this case).
- (4) Standard PDU chassis color is black, custom color available on request.
- (5) These PDUs have no Surge Suppression or On/Off Switch.
- (6) PDU "Dog House" hosts the circuit breaker and protrude from the PDU chassis by 1.44".
- (7) All these 3-Phase PDUs are vertically mounted.



Single- and 3-Phase Switched PDUs



Front View 9SO5-080001



Rear View 9SO5-080001



9SJ2-241010

UL Listed Single- and 3-Phase PDUs

Type: S = Remotely Switched

Belden Part #	Type	De-Rated Power (kW)	Amps (A) x Phases	Input Volts (V)/ Output Volts (V)	Plug Type	Total Receptacle	Receptacle Type/ Qty(s)	Circuit Breaker (Amp/Qty) (4)	Monitoring-Local/ Remote	Mounting (5)	Dimensions L x W x D (in.)
9SG1-081001	S	1.9	20	120/120	5-20P	8	5-20R/8	No	Power/Agg Power	Rack - 19"	17 x 1.72 x 8.5 Dog House - No
9SO5-080001	S	1.9 or 3.3	20	120 or 208/120 or 208	C-20	8	C-13L/8	No	Power/Agg + Outlet	Rack - 19"	17 x 1.72 x 8.5 Dog House - No
9SB2-241007	S	5	30	208/208	L6-30P	24	C-13L/18 + C-19L/6	20/2D	Power/Agg, Circuit, Outlet	Vertical	66.25 x 2 x 2.6 Dog House - No
9SJ2-241007	S	8.6	30 x 3 Ph.	120/208 WYE/208	L21-30P	24	C-13L/18 + C-19L/6	20/3D	Power/Agg, Circuit	Vertical	66.25 x 2 x 2.6 Dog House - No
9SJ2-241010	S	8.6	30 x 3 Ph.	120/208 WYE/208	L21-30P	24	C-13L/18 + C-19L/6	20/3D	Power/Agg, Circuit, Outlet	Vertical	66.25 x 2 x 2.6 Dog House - No
9SD2-361001	S	16.6	30 x 3 Ph.	230/400 WYE/230	L22-30P	36	C-13L/24 + C-19L/12	20/6	Power/Agg, Circuit	Vertical	72 x 2 x 2.6 Dog House - No
9SD2-361002	S	16.6	30 x 3 Ph.	230/400 WYE/230	L22-30P	36	C-13L/24 + C-19L/12	20/6	Power/Agg, Circuit, Outlet	Vertical	72 x 2 x 2.6 Dog House - No
9SL3-361001	S	17.2	60 x 3 Ph.	208 Delta/208	3P, 4W	36	C-13L/24 + C-19L/12	20/6D	Power/Agg, Circuit	Vertical	66.25 x 3.7 x 2.6 Dog House - No
9SL3-241006	S	17.2	60 x 3 Ph.	208 Delta/208	3P, 4W	24	C-13L/12 + C-19L/12	20/6D	Power/Agg, Circuit, Outlet	Vertical	60 x 2.25 x 2.6 Dog House - No

Notes:

- (1) Standard cord exits from chassis face; top of chassis exit available on request.
- (2) C-13L, L refers to receptacles with locking feature.
- (3) Ex: 20/3D, D refers to double pole breakers (20A in this case).
- (4) Standard PDU chassis color is black, custom color available on request.
- (5) These PDUs have no On/Off Switch or Surge Supression.
- (6) PDU "Dog House" hosts the circuit breaker and protrude from the PDU chassis by 1.44".
- (7) All these Single- and 3-Phase PDUs have a Switched Outlet and a 1-port Environmental Monitor.

Faster.
Easier.
Better.



PDU Accessories — Mounting, Cord Management and Cord Set



Description	Belden Part Number
Tool-Less PDU Mounting Panel (for XHM and XHS Style Cabinets)	
Lacing-PDU Mounting Panel, 3.5"W, 42RU, Black	HVMP014201
Lacing-PDU Mounting Panel, 3.5"W, 45RU, Black	HVMP014501
Lacing-PDU Mounting Panel, 3.5"W, 48RU, Black	HVMP014801
Lacing-PDU Mounting Panel, 7"W, 42RU, Black	HVMP024201
Lacing-PDU Mounting Panel, 7"W, 45RU, Black	HVMP024501
Lacing-PDU Mounting Panel, 7"W, 48RU, Black	HVMP024801
Lacing-PDU Mounting Panel, 3.5"W, 42RU, White	HVMP014202
Lacing-PDU Mounting Panel, 3.5"W, 45RU, White	HVMP014502
Lacing-PDU Mounting Panel, 3.5"W, 48RU, White	HVMP014802
Lacing-PDU Mounting Panel, 7"W, 42RU, White	HVMP024202
Lacing-PDU Mounting Panel, 7"W, 45RU, White	HVMP024502
Lacing-PDU Mounting Panel, 7"W, 48RU, White	HVMP024802
Power Cord Management	
Cable Management Ring Plastic (Qty = 5) 3" x 1.5" Reversible	XMR01
Cable Management Ring Kit (Qty = 5) 2.5"W x 3"D	XMR03
Slack Management Spool Kit (includes 2 spools)	BHSP020
Quick Mount Base (Qty=10) with Fastener, for 1/4" Holes	XCTM
Velcro Cable Ties, 25 per Roll, 8" L x 0.5"W	AX100783
Velcro Cable Ties, 25 per Roll, 12" L x 0.5"W	AX100784
Cord Set (C13/C19, C19/C20 - UL - cUL Listed)	
C13 to C14 Non-Locking Cord Set - Y" Long — Black	CSC13C14yyBK
C13 to C14 Non-Locking - 36" Long — Black	CSC13C1436BK
C13 to C14 Non-Locking - 48" Long — Black	CSC13C1448BK
C19 to C20 Non-Locking Cord Set - Y" Long — Black	CSC19C20yyBK
C19 to C20 Non-Locking - 36" Long — Black	CSC19C2036BK
C19 to C20 Non-Locking - 48" Long — Black	CSC19C2048BK

Notes: yy = 12, 24, 36 ... 96 = cord length 12 to 96 inches; 12 inch increments.

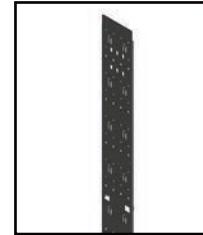

7" Lacing-PDU mounting panel

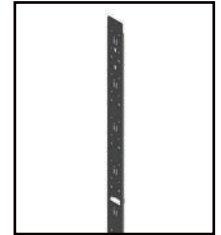

3.5" Lacing-PDU mounting panel



Cable Management Ring (Plastic)



Quick Mount Base

PDU Configuration Guide

Please select the desired configuration and specifications and submit to Belden.

Power Availability _____ Phone _____ E-mail _____
 Quantity Required _____ Target Price _____ Project Timeline _____
 First Unit Required by Date _____ Comparable Competitive Unit Brand/ Model# _____

Electrical Configuration

Power Input			
Quantity**	Plug Type	Input AMPS	Input VOLTS
	5-15P	15	125
	L5-15P	15	125
	5-20P	20	125
	L5-20P	20	125
	6-20P	20	250
	L6-20P	20	250
	L14-20P	20	125/250
	L21-20P	20 x 3-	120/208 WYE
	L5-30P	30	125
	L6-30P	30	250
	L14-30P	30	125/250
	L15-30P	30 x 3-	250 Delta
	L21-30P	30 x 3-	120/208 WYE
	IEC C-20 Inlet (No Cord)	20/16*	125 or 250
	IEC Pin & Sleeve 2 Pole/3 Wire	20/16*	250/230*
	IEC Pin & Sleeve 3 Pole/4 Wire	20	250 3-
	IEC Pin & Sleeve 2 Pole/3 Wire	30/32*	250/230*
	IEC Pin & Sleeve 3 Pole/4 Wire	30	250 3-
	IEC Pin & Sleeve 2 Pole/3 Wire	60/63*	250/230*
	IEC Pin & Sleeve 3 Pole/4 Wire	60	250 3-
Cord Length			

Power Input			
Quantity	Receptacle Type	AMPS	VOLTS
	5-15R Duplex	15	125
	5-15R Individual	15	125
	L5-15R Duplex	15	125
	5-20R Duplex	20	125
	5-20R Individual	20	125
	L5-20R	20	125
	6-20R Duplex	20	250
	L6-20R	20	250
	L5-30R	30	125
	L6-30R	30	250
	IEC C-13	15/10*	125 or 250
	IEC C-19	20/16*	125 or 250
Other - Please Specify			

Physical Configuration			
Dimensional Limits		Mounting Orientation	
	Length		Horizontal
	Width		Vertical
	Height		

Hardwire Options	
Quantity**	
	6" Wire Tails with Removable Plate
	Flexible Conduit
	Terminal Block

Power Switch	Surge Suppression
	No
	Yes
	Yes - with Cover

Monitoring	
Current Local	Current Remote
	No
	Yes -
	Current (Amps) Only
	Yes - Circuit Level
	Yes - Scrolling Display (Volts, Amps, Watts, Power Factor)
	Yes - Outlet Level

Environmental	Remote Switching
	No
	Yes

Circuit Breakers	Isolated Ground
	No (required by NEC in some units)
	Yes

3rd Party Testing - Compliance	
	UL® Listed
	FCC Part 15 Class A
	None Required
	UR - UL® Recognized
	CE®
	Other - Please Specify

Additional Information

Notes:
 *Rating for CE Products
 **Quantity = # of Circuits

Faster.
Easier.
Better.



Plug and Receptacle Configuration Chart

NEMA Plugs and Receptacles

AMP	VOLTS	Straight-Blade Plug	Straight-Blade Receptacle	AMP	VOLTS	Straight-Blade Plug	Straight-Blade Receptacle
15	125	5-15P	5-15R	20	250	6-20P	6-20R
20	125	5-20P	5-20R				
AMP	VOLTS	Twist-Lock Plug	Twist-Lock Receptacle	AMP	VOLTS	Twist-Lock Plug	Twist-Lock Receptacle
15	125	L5-15P	L5-15R	20	120/208 x 3- WYE	L21-20P	L21-20R
20	125	L5-20P	L5-20R	20	230/400 x 3- WYE	L22-20P	L22-20R
30	125	L5-30P	L5-30R	30	120/208 x 3- WYE	L21-30P	L21-30R
20	250	L6-20P	L6-20R	30	230/400 x 3- WYE	L22-30P	L22-30R
30	250	L6-30P	L6-30R	30	250 x 3- Delta	L15-30P	L15-30R
20	125/250	L14-20P	L14-20R	AMP	VOLTS	California Style	
30	125/250	L14-30P	L14-30R	50	250 x 3- Delta	3P, 4W	3P, 4W

IEC Plugs and Receptacles

AMP	VOLTS	Power Inlet	Power Receptacle	AMP	VOLTS	Power Inlet	Power Receptacle
15/10*	125 or 250	C-14	C-13	20/16*	125 or 250	C-20	C-19
AMP	VOLTS	Pin & Sleeve		AMP	VOLTS	Pin & Sleeve	
20/16*	250/230*	2P, 3W	2P, 3W	60/63*	250/230*	2P, 3W	2P, 3W
20	250	3P, 4W	3P, 4W	60	250	3P, 4W	3P, 4W
30/32*	250/230	2P, 3W	2P, 3W	20/16*	230/400* x 3- WYE	4P, 5W	4P, 5W
30	250	3P, 4W	3P, 4W	30/32*	230/400* x 3- WYE	4P, 5W	4P, 5W

*Rating for CE Products

What is 3-Phase Delta?

3-Phase Delta from 208V Source

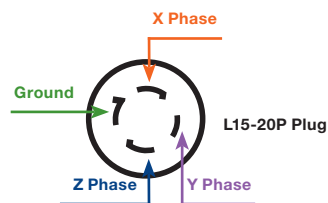

A 3-Phase Delta is a 4-wire configuration consisting of 3-Phase conductors (X, Y and Z) and a Ground. Without the neutral present, only phase-to-phase wiring is possible. The potential between any 2-Phase conductors is typically 208V.

What is 3-Phase WYE?

3-Phase Delta from 120/208V Source

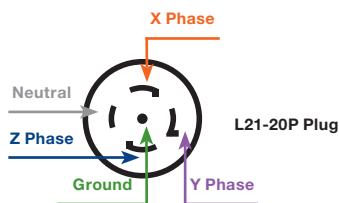

A 3-Phase Delta 120/208V WYE is a 5-wire configuration consisting of 3-Phase conductors (X, Y and Z), Neutral and Ground. The potential between any 2-Phase conductors is 208V. The potential between any phase and neutral is 120V. This configuration can be wired to provide 120V, 208V or a combination of both voltages within one PDU.

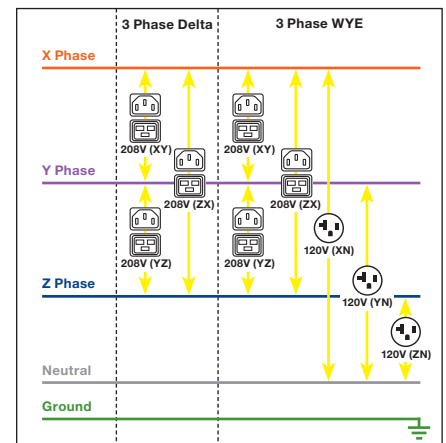

Power Distribution & Climate Monitoring



Environmental Monitors and Sensors



9318-0500



9318-0521

Applications

- Belden climate monitors and sensors allow precise monitoring/alarmed of key environmental parameters for improved equipment availability in mission-critical applications (data center, networking closet, remote locations)
- Built-in intuitive web interface for remote access via Ethernet browser
- Built-in and external sensor options (temperature, humidity, airflow, water detection, door position, smoke)
- SNMP-enabled for compatibility with leading DCIM package
- Recognize IP-based camera for space viewing
- Set alarm threshold, can be sent to up to five e-mail addresses
- Allows viewing of data graphs and analysis of historical logs
- Power supply included
- UL and cUL listed



9318-0503 Temp/Airflow/Humidity Remote Sensor



9318-0506 Remote PDU Display

Description	Belden Part Number
-------------	--------------------

Other Accessories

Environmental Monitors

Compact Self-Contained Environmental Monitor (5.25"Lx1.75"Hx1.5"W); Provides Web-Based Remote Surveillance with On-Board Temperature and Humidity/Dew Point Sensors. Has Input Capacity for Two External Sensors	9318-0500
--	-----------

Rack-Mount 1RU Environmental Monitor. Provides Web-Based Remote Surveillance of Temperature and Relative Humidity. Up to (4) Additional Digital Sensors Can Be Connected to the Unit by daisy-chaining or using a splitter.	9318-0521
---	-----------

Environmental Monitors Accessories

RJ12 5-Way Splitter	9318-0520
Remote PDU Display, RJ12 Connection	9318-0506

Sensors (compatible with environmental monitors and intelligent PDU)

Remote Temperature Sensor with 12 ft. Wire	9318-0501
Remote Temperature Sensor with 25 ft. Wire	9318-0544
Remote Temperature/Airflow/Humidity and Dew Point Sensor with 12 ft. Wire	9318-0503
Remote Temperature/Airflow/Humidity and Dew Point Sensor with 20 ft. Wire	9318-0515
Remote Temperature/Airflow/Humidity and Dew Point Sensor with 50 ft. Wire	9318-0516
Remote Door Position Analog Sensor	9318-0504
Remote Water Detection Analog Sensor	9318-0534

ReelTuff™ Packaging



Strong and ruggedized to provide superior resistance to the crushing, puncturing, tearing and water exposure experienced during shipping and handling.



Lighter and easier to carry than boxes with wooden reels, with tear-resistant, easy-to-access, reinforced handles.



Easy-to-read labels, descending length marking and the ability to pull multiple cables vertically through stacked boxes make installation faster and easier!



Warranty and Shipping Policy

Warranty

Limited Warranty

Belden warrants that, for a period of one (1) year following the date of delivery to the original customer, the products it offers for sale in the catalog are free from defects in material and workmanship. The foregoing warranty is subject to the terms, limitations and conditions set forth below.

Liability

Belden's sole liability under this warranty will be to repair or replace, at its discretion, products that do not meet the specifications and descriptions provided in the catalog or purchase order due to defects in material and workmanship. Under no circumstances shall Belden be liable for any consequential or special damages for breach of this warranty. Belden's total liability under this warranty shall be limited to the price actually paid by the customer for the product(s) covered. Except as specifically set forth above, Belden expressly disclaims any other representation or warranties of any kind, expressed or implied, arising by law or custom, with respect to products set forth in the catalog or otherwise sold by Belden, including without limitation, warranties or merchantability, fitness for a particular purpose, non-infringement or any other matter.

Conditions of Warranty

This warranty applies only to standard products set

forth in the catalog. Custom products are covered by warranties stated in the Terms and Conditions of Belden's quotation at the time of the order.

Repairs or Adjustments

Belden, at its discretion, will make any repairs or adjustments to any products that are due to defects and/or workmanship. This warranty does not extend to any items that upon inspection by Belden are deemed to have been misused, neglected, improperly treated, improperly installed, or used in violation of instructions or specifications approved by Belden, or otherwise handled, installed, shipped or used in violation of industry standards for metal fabrication and solid state electronic equipment.

Powerstrip Warranty

If a BELDEN power strip product becomes defective during the warranty period listed below, BELDEN will elect to either repair or replace the unit free of charge.

Basic Power Strips – Five Years

Metered, Monitored and Managed Power Strips – Five Years

Environmental Monitoring Units – Five Years

This warranty does not include damage to the product resulting from accident or misuse, including exposure to water or any other

corrosive material. This warranty excludes damage to equipment if surge or spike reaches that equipment through an unprotected source connected to it (i.e., printer, modem, phone line, etc.). It shall not apply to any product, which has been connected, installed, used or otherwise adjusted other than in accordance with written instructions furnished by BELDEN.

WARRANTY WILL BE VOIDED IF THE UNITS ARE OPENED, MODIFIED OR ALTERED DURING THE WARRANTY PERIOD.

Containment and Cooling Warranty

BELDEN warrants Containment and Cooling products for a period of one (1) year following the date of delivery. If the BELDEN product becomes defective during the one (1) year warranty period, BELDEN will elect to either repair or replace the unit free of charge. This warranty does not include damage to the product resulting from accident or misuse, including exposure to water or any other corrosive material.

WARRANTY WILL BE VOIDED IF THE UNITS ARE OPENED, MODIFIED OR ALTERED DURING THE WARRANTY PERIOD.

Shipping Policy

Freight Handling Charges

Third-Party Billing – Customer will specify carrier. Freight will be third-party billed other than to Belden or the customer.

The customer will supply a third-party account number or third-party billing address.

Freight Collect – Customer to specify carrier. Either a freight account number is provided or freight charges will be paid at destination upon delivery.

Prepaid and Add – Belden will specify carrier which has contractual agreements with select carriers.

All freight charges that appear on initial product invoice will be paid by the customer, and will not require any additional freight documentation. Belden's billing cycle will only indicate on the invoice a freight charge from dock to dock. Any accessorial charges (e.g., lift gate, union driver) will be billed on an additional invoice other than the initial billing that will show the accessorial charges.

Shipping Policy

Belden will provide estimated freight charges and will not be liable for charges due to problems that may occur in transit or upon delivery or not known at the time of the initial quote (accessorial charges). All shipments leaving Belden are FOB origin.

Inside Delivery – A carrier driver will make an inside delivery if an adequate loading dock is available to roll off freight to a trailer level dock. The driver will be equipped to move the freight via hand truck or pallet jack and must be able to get to the inside destination without any problem of obstacles that would cause delays. The customer must supply a freight elevator if delivery requires it. This action may result in additional freight charges.

Lift Gate Service – Usually a lift gate is needed when a loading dock is not available. The freight is lowered to ground level and delivered to the customer's door "only." Not all trailers are equipped with a lift gate and most carrier terminals have a limited number of lift gate trailers. This may

cause a delay in shipment. This procedure may require an additional fee.

Notification – To coordinate delivery between the customer and the carrier, the customer must supply a phone number and contact person. This procedure may require an additional fee.

Re-Consignment – Once freight has left the Belden dock, the delivery destination address will be scheduled in the carrier dispatch system. A change of destination address is possible, depending upon the timing of delivery. This action may result in additional freight charges.

Redelivery – When a delivery is refused by a customer for any reason, other than the fault of the carrier, the freight will be returned to the carrier's dock. A redelivery charge will apply.

Damages

All damages must be reported to Belden within three (3) working days upon delivery. Failure to report any damages will release Belden from any and all claims. It is the responsibility of the

Faster.
Easier.
Better.

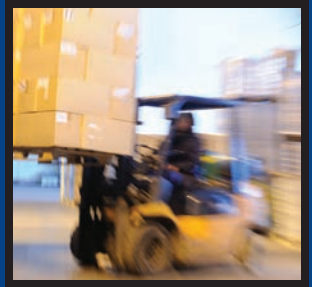

customer's receiving personnel to check all shipping cartons for discrepancies (e.g., dents, punctures). All discrepancies to the shipping container should be noted on the carrier's paperwork and documented. If, after opening the container, it is found that there is damage to the product, the carton is to be examined to determine that the damage was due to shipping. Failure to examine cartons at delivery, and signing the carrier's paperwork, releases the carrier and Belden from any and all freight claims.

Third-party billing customers will handle any and all freight claim damage with the carrier and are responsible for all freight charges.

Packaging

BELDEN cabinets are packaged in cardboard protective corner posts and protective plastic cover. The cabinets are then secured to a skid by banding prior to shipment.

Less than truck load shipments (LTL) might

require additional packaging due to multiple handling locations. Belden provides full protective packaging (i.e. 3" honeycomb cardboard corner posts, honeycomb top cardboard cover, cardboard wrap, shock-watch drop spot indicator) for an additional fee to accommodate LTL shipments with special needs. Please contact your customer service or sales rep to discuss the packaging options.

Return Policy for Repair, Replacement, Modification or Credit

Prior approval must be obtained for any products being returned. Upon approval an RMA number will be assigned to the items being returned. This RMA number MUST appear on all shipping documents and on the outside of each carton. Failure to include the RMA number on the carton will result in the refusal of delivery and return to the customer, freight collect.

All products returned for reasons other than repair or replacement are subject to a 15% restocking

fee and must be shipped prepaid. In addition to the 15% restocking fee, the customer is responsible for properly packaging and returning the product in reusable condition. If not, additional charges may be added to the restocking fee. If a customer holds a product for more than ten (10) days, a return for credit will be voided.

Any or all special customized products can only be returned for modifications or repair of damages.

All products being returned shall be prepaid (unless they are being returned due to defect or damage), packaged in good condition and shipped to:

Belden
2001 North Main Street
Washington, PA 15301

Belden Rack and Cabinet Manufacturing

State-of-the-Art Manufacturing and Assembly Operation

Lean Manufacturing

Belden's lean manufacturing philosophy is exemplified in its manufacturing plant, where infrastructure solutions, including racks, cabinets, heat containment and rack power distribution units, are produced. The plant is structured for cell-based manufacturing, where automated machines, such as the CNC punch press, CNC laser-punch combination machine and CNC CO₂ lasers, work seamlessly with semi-automated metal-bending machines and assembly operations.



Environmentally Friendly Powder Coating

Belden's powder-coating process involves industry leading five-stage wash and pre-treatment steps, ensuring a lasting and durable finish. Each cabinet is baked in compliance with ASTM standards to prevent paint from scaling or chipping, thus ensuring rust-proof cabinets. The entire process is environmentally friendly, with complete conformance to both state and federal "Clean Air Act" guidelines.



ensure each customer's quality and delivery expectations are met in a safety conscious work environment.

Fabrication

Precision CO₂ lasers with automated loading and unloading capabilities are at the heart of our sheet metal fabrication cell, with defect-free laser cutting at speeds up to 400 inches per minute. The parts are then sent through a continuous flow of metal forming, robotic welding, powder coating and assembly cells.



Packaging and Shipping

In order to provide our customers with high-performance cabinet systems and just-in-time delivery, the factory process flow is based on a value stream map, with raw materials received at a receiving dock (close to fabricating cells) and finished goods shipped from a shipping dock (close to the packaging cell). All cabinets are shipped with unique serial number tags, enabling full traceability.



Quality Inspection

The cell-based assembly process includes stringent quality checks at each location within the cell, which are tracked in an assembly check list by each associate assembling a cabinet system. Throughout this manufacturing process, the external quality, measured in defects per million, is less than 100. Lean daily management (LDM) and continuous improvement processes drive manufacturing and design philosophy at Belden to



Our modern manufacturing and assembly facility

ensures that customers receive the quality products they've come to expect.

Part Number Index

Part No.	Page	Part No.	Page	Part No.	Page	Part No.	Page	Part No.	Page
9BF1-061001	72	9015-1909	64	BEH-SKE2S-S	68	BHVHL10	41, 45	BLWAS421-18B	25
9BF1-061002	72	9318-0500	78	BEH-SKK2S-S	68	BHVHL12	41, 45	BLWAS421-24B	25
9BF1-081001	72	9318-0501	78	BEH-SMHE2S-S	68	BHVL003	41, 45	BSP-ADPLATE	38
9BF1-141001	72	9318-0503	78	BEH-SMHMH2S-S	68	BHVL006	41, 45	BSP-CBRKT	38
9BG1-101001	72	9318-0504	78	BEH-SW10	68	BHVL010	41, 45	BSP-LOCK-C1	38
9BG1-141001	72	9318-0506	78	BEH-SW20	68	BHVL012	41, 45	CSC13C1436BK	75
9BG1-141002	72	9318-0515	78	BEH-SW50	68	BLBSS487-OUB	25	CSC13C1448BK	75
9BG2-081001	72	9318-0516	78	BEH-SW100	68	BLBSS488-OUB	25	CSC19C2036BK	75
9BG2-141001	72	9318-0520	78	BEH-SW250	68	BLBSU301-15B	25	CSC19C2048BK	75
9BG2-141002	72	9318-0521	78	BHBC03X	45	BLCRP596-06B	25	FFZH00BB	21
9BJ2-331001	73	9318-0534	78	BHBC06X	45	BLCRP596-56B	25	FFZH06KC	21
9BL3-241002	73	9318-0544	78	BHBC10X	45	BLCSB959-15B	25	FFZH08KC	21
9LF1-101001	72	9420-1905	66	BHBC12X	45	BLCSB959-15W	25	HCB-1932-1.5-01	65
9LG1-101001	72	9420-1906	66	BHBD03X	45	BLCSB959-24B	25	HCB-1932-2.5-01	65
9OB2-241003	72	9510-1901	65	BHBD06X	45	BLCSB959-24W	25	HCC001-B	32
9OC2-361001	73	9511-1902	65	BHBD10X	45	BLCSK362-12B	25	HCC001-W	32
9OD3-361001	73	9511-1902-01	65	BHDB12X	45	BLCSK362-18B	25	HCCBP-B	32
9OJ2-241005	73	9511-1903-01	65	BHDK03X	45	BLCSK362-24B	25	HCCBP-W	32
9PB2-101002	72	9511-1904-01	65	BHDK06X	45	BLEB822-12B	25	HCDBP-B	32
9PB2-361005	72	9512-1901	45, 65	BHDK10X	45	BLEB822-12W	25	HCDBP-W	32
9PB2-361007	72	9512-1902-FR	65	BHDK12X	45	BLEB822-18B	25	HCFD10	32
9PB2-361009	72	9512-1902N	45, 65	BHFB11U	45	BLEB822-18W	25	HCFD30	32
9PB2-421003	72	9512-1903	59, 62	BHFS11U	45	BLEB822-24B	25	HCH001	32
9PC2-301001	73	9714-0190	67	BHGL03X	45	BLEB822-24W	25	HCP001	32
9PD2-301002	73	9910-0100-01/-02	66	BHGL06X	45	BLFK309-01B	25	HCP002	32
9PD3-301001	73	9910-0100PL-01/-02	66	BHGL10X	45	BLJSU302-15B	25	HN4530FFD01	34
9PG1-101001	72	9911-0200-01/-02	66	BHGL12X	45	BLOR723-12B	25	HN4530FFD02	34
9PH2-241007	72	9911-0200PL-01/-02	66	BHGR03X	45	BLOR723-12W	25	HN4530GD01	34
9PI2-421004	73	9911-0201-01	66	BHGR06X	45	BLOR723-18B	25	HN4530GD02	34
9PJ2-421001	73	9912-0300-01/-02	66	BHGR10X	45	BLOR723-18W	25	HN4530GKD01	34
9PJ2-421003	73	9913-0400-01/-02	66	BHGR12X	45	BLOR723-24B	25	HN4530GKD02	34
9PL3-241006	73	9914-0800-01/02	66	BHH191UC	65	BLOR723-24W	25	HN4530SD01	34
9SB2-241007	74	20128-KIT	67	BHH191UFR	65	BLPEC642-002	25	HN4530SD02	34
9SD2-361001	74	AX100783	21, 67, 75	BHH191UR	45, 65	BLREK506-02B	25	HN4536SP01	34
9SD2-361002	74	AX100784	21, 67, 75	BHH192UC	65	BLREK506-04B	25	HN4536SP02	34
9SG1-081001	74	AX102516	67	BHH192UFR	65	BLREK506-06B	25	HN4542SP01	34
9SJ2-241007	74	AX102517	67	BHH192UR	45, 65	BLREK506-12B	25	HN4542SP02	34
9SLJ2-241010	74	AX105366	21	BHH193UC	65	BLREK506-16B	25	HRSBK01	17
9SL3-241006	74	AX105367	21	BHH193UR	45, 65	BLREK506-18B	25	HRSBK02	17
9SL3-361001	74	AX107623	39	BHH194UC	65	BLRRD100-12B	25	HSNTBK30101	19
9S05-080001	74	BEH-CTRL	68	BHH194UR	45, 65	BLRRD100-18B	25	HSNTBK30102	19
8910-0100	67	BEH-EN	68	BHPF100	45	BLRRD101-12B	25	HSNTBK30201	19
8911-0100	67	BEH-ENHF	68	BHRR194	44	BLRS250-12B	25	HSNTBK30202	19
8913-0100	67	BEH-ENHFLF	68	BHRSK020	45	BLRS250-12W	25	HSNTBK40101	19
8913-0220	67	BEH-ENLNF	68	BHSM100	45	BLRS250-18B	25	HSNTBK40102	19
8913-0320	67	BEH-NBB2S-S	68	BHSP020	21, 45, 75	BLRS250-18W	25	HSNTBK40201	19
8914-0100	67	BEH-NBE2S-S	68	BHSP030	21	BLRS250-24B	25	HSNTBK40202	19
8915-0100	67	BEH-NCHCH2S-S	68	BHTD196	45	BLRS250-24W	25	HSTBK30101	17
8915-0220	67	BEH-NCHE2S-S	68	BHTL196	45	BLRT252-12B	25	HSTBK30102	17
8915-0320	67	BEH-NCHLCHL2S-S	68	BHTT196	45	BLRT252-12W	25	HSTBK30201	17
8917-0100	67	BEH-NCHLE2S-S	68	BHTTH196	45	BLRT252-18B	25	HSTBK30202	17
8917-0125	37	BEH-NEE2S-S	68	BHVH003	41, 45	BLRT252-18W	25	HSTBK30301	17
8917-0220	67	BEH-NKE2S-S	68	BHVH006	41, 45	BLRT252-24B	25	HSTBK30302	17
8917-0320	67	BEH-NKK2S-S	68	BHVH008	45	BLRT252-24W	25	HSTBK40101	17
9010-1924	64	BEH-NMHE2S-S	68	BHVH010	41, 45	BLRTR595-9B	25	HSTBK40102	17
9010-1930	64	BEH-NMHMH2S-S	68	BHVH012	41, 45	BLRTR595-15B	25	HSTBK40201	17
9010-1936	64	BEH-SAPS	68	BHVHH03	41, 45	BLRTR595-24B	25	HSTBK40202	17
9011-1912	64	BEH-SBB2S-S	68	BHVHH06	41, 45	BLTSB312-12B	25	HVGB0142	21
9011-1918	64	BEH-SBE2S-S	68	BHVHH08	45	BLTSB312-18B	25	HVGB0145	21
9011-1918-16	64	BEH-SCHCH2S-S	68	BHVHH10	41, 45	BLTSB746-12B	25	HVGB0148	21
9012-1918	64	BEH-SCHE2S-S	68	BHVHH12	41, 45	BLTSB746-18B	25	HVMP014201	75
9012-1918-16	64	BEH-SCHLCHL2S-S	68	BHVHL03	41, 45	BLVBS489-OUB	25	HVMP014202	75
9013-1924	64	BEH-SCHLE2S-S	68	BHVHL06	41, 45	BLWAS421-12B	25	HVMP014501	75

Faster.
Easier.
Better.



Part No.	Page	Part No.	Page	Part No.	Page	Part No.	Page	Part No.	Page
HVMP014502	75	XCPE244812-S01	40	XFI48U2848-S007	26	XHW-4806-PD	37	XRES1414VHD	39
HVMP014801	75	XCPE244812-S02	40	XFPWB1U101/02	66	XHW-4806-SD	37	XRES2114	39
HVMP014802	75	XCS-00-01	66	XFPWB2U101/02	66	XHW-4824-GD	37	XRES2114FC	39
HVMP024201	75	XCS-02-01	66	XFPWB3U101/02	66	XHW-4824-PD	37	XRES2114VHD	39
HVMP024202	75	XCS-04-01	66	XFPWB4U101/02	66	XHW-4824-SD	37	XRES2814	39
HVMP024501	75	XCS-05-01	66	XH1S45-C1000	15	XHW-4830-GD	37	XRES2814FC	39
HVMP024502	75	XCS-06-01	66	XH1S45-C2000	15	XHW-4830-PD	37	XRES2814VHD	39
HVMP024801	75	XCS-08-01	66	XH2S45-C1000	15	XHW-4830-SD	37	XRES4214	39
HVMP024802	75	XCTM	75	XH2S45-C1001	15	XHWBRUSHKIT	37	XRES4214FC	39
HWFS24	36	XCTV12	56, 59, 62	XH2S45-C2000	15	XHWCOVERKIT	37	XRES4214VHD	39
HWFS36	37	XCTV18	56, 59, 62	XH2S45-C2001	15	XHWFANKIT115V	37	XRESBR-005	39
HWFS48	37	XCTV24	56, 59, 62	XH3M45-1100000	44	XHWFANKIT230V	37	XRESBR-006	39
HVWMP012401	36	XDR8419-3M6	44	XHW24BBD	36	XHWFILTERKIT	37	XRESBR-007	39
HVWMP013601	37	XDR8419-3M62836	44	XHW24RLS1224	36	XHWFOOTKIT	37	XRESBR-009	39
HVWMP014801	37	XDR8419-310N	44	XHW36BBD	37	XHWGROMMETKIT	37	XSFBK01	67
PPC-5M-U/U	39	XDR8419-310N1M	44	XHW36RLS1224	37	XHWMBKT	37	XSW-0100	47
PPC-5M-U/UPI	39	XDR8419-310N2M	44	XHW48BBD	37	XLDES-S01	40	XSW-0200	47
PPC-5M-U/UPS	39	XDR8419-310W	44	XHW48RLS1224	37	XLK01	21	XSW-8419	47
PPC-9M-U/U	39	XDR8419-312N	44	XHW-2406-GD	36	XLKS-1-S01	40	XTCM01	21
PPC-9M-U/UPI	39	XDR8419-312N1M	44	XHW-2406-PD	36	XMEBK01	59, 62, 67	XUFPE252512-S01	40
PPC-9M-U/UPS	39	XDR8419-312N2M	44	XHW-2406-SD	36	XMEEG01	59	XUFPE25254-S01	40
PPC-GHS-2E	39	XDR8419-312W	44	XHW-2424-GD	36	XMEGK01	59, 62	XUFPE25257-S01	40
PPC-GHS-3E	39	XDR8419-610	44	XHW-2424-PD	36	XMELM	59, 62	XUFPE252512-S01	40
PPC-GHS-4E	39	XDR8419-612	44	XHW-2424-SD	36	XMERSB	59, 62	XWB-2U	46
RACK-MOUNT LACING BAR	62	XDR8419-3102836	44	XHW-2430-GD	36	XMFBK01	56, 67	XWB-4U	46
VCMFDR4X4	45	XDR8419-3122836	44	XHW-2430-PD	36	XMFBK02	56, 67	XWB-6U	46
XBK01	21, 67	XDR8419VGB01	44	XHW-2430-SD	36	XMFBK03	56	XWR-1219	46
XBS-11-0001-KIT	67	XDRGIK-19	44	XHW-3606-GD	37	XMFACTM	53, 56, 59, 62, 67	XWR-3619-18	46
XBS-18-0001-KIT	67	XDRPDUK401	44	XHW-3606-PD	37	XMFEK01	56	XWR-3619-18HD	46
XCAE242412-S01	40	XDRS8419-610	44	XHW-3606-SD	37	XMFEK02	56	XWR-4819-18	46
XCAE244812-S01	40	XDRS8419-61028	44	XHW-3624-GD	37	XMFSB	56	XWR-4819-18HD	46
XCAERF2X2-S01	40	XDRS8419-61032	44	XHW-3624-PD	37	XMR01	21, 75	XZUK01	21
XCAERF2X4-S01	40	XFI44U2848-S002	26	XHW-3624-SD	37	XMR02	21	XZUK02	21
XCK01	21	XFI44U2848-S003	26	XHW-3630-GD	37	XMR03	21, 75		
XCK02	21	XFI44U2848-S004	26	XHW-3630-PD	37	XPE-S0001	46		
XCPE242412-S01	40	XFI48U2848-S005	26	XHW-3630-SD	37	XRES1414	39		
XCPE242412-S02	40	XFI48U2848-S006	26	XHW-4806-GD	37	XRES1414FC	39		

Part Number Index