

# SOP, SSOP, TSOP

## IC51 Series

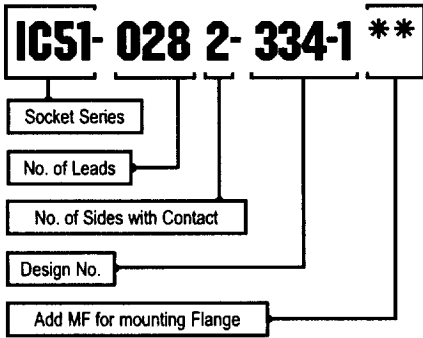
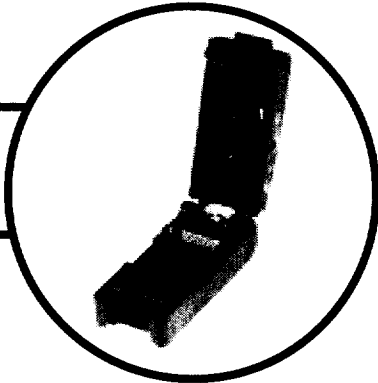

Insulation Resistance:  
Withstanding Voltage:  
Contact Resistance:  
Operating Temperature:

### Characteristics

1,000M $\Omega$  minimum at 500 VDC  
700 VAC for 1 Minute  
30m $\Omega$  max. at 10mA/20mV (Initial)  
-40°C ~ +150°C

Insulator:  
Contact:  
Plating:

### Material

PES / PEI (Glass Filled)  
Beryllium Copper  
Gold over Nickel

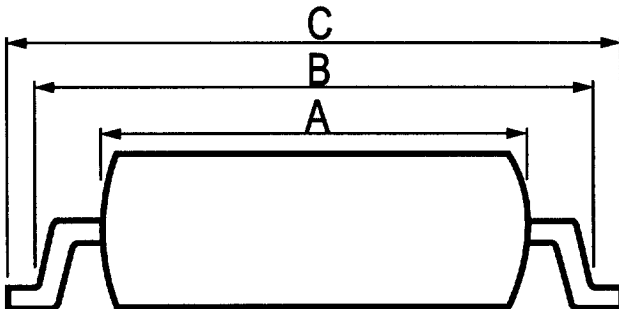

**A:** Body Width  
**B:** Inside of Flat Portion  
**C:** Tip to Tip

Part Number	No. of Leads	Body Width	Pitch	Matching Package			Notes
				A (Max)	B (Max)	C (Nominal)	
IC51-0082-1024	8	5.2	1.27mm	5.3	7.2	7.9	Floating Base
IC51-0102-987	10	5.2	1.27mm	5.3	7.2	7.9	Floating Base
IC51-0142-084	14	4.5	1.27mm	4.5	5.7	6.0	Separator
IC51-0142-189	14	7.0	1.27mm	7.0	8.9	10.0	Separator
IC51-0142-951	14	4.4	1.25mm	4.5	5.2	6.0	Separator
IC51-0142-1013	14	5.2	1.27mm	5.3	7.2	7.9	Floating Base

**Note:** Sockets with "separator" can accept and properly align lower pin count devices. Sockets with "Floating Base" will only accept devices with the same pin count as the socket.

# SOP, SSOP, TSOP

## IC51 Series

Part Number	No. of Leads	Body Width	Matching Package				Notes
			Pitch	A (Max)	B (Max)	C (Nominal)	
IC51-0122-1836	12	4.4	0.80mm	4.40	5.90	6.40	Separator
IC51-0162-109	16	5.2	1.27mm	5.20	6.00	7.20	Separator
IC51-0162-163	16	4.5	1.27mm	4.50	5.70	6.00	Separator
IC51-0162-225	16	4.4	1.27mm	4.40	5.40	6.00	Separator
IC51-0162-271-1	16	5.5	1.27mm	5.50	5.20	6.00	Separator
IC51-0162-271-2	16	5.0	1.27mm	5.00	5.20	6.00	Separator
IC51-0162-272-1	16	5.5	1.27mm	5.50	5.70	6.50	Separator
IC51-0162-273-1	16	5.5	1.27mm	5.50	6.22	7.00	Separator
IC51-0162-273-2	16	5.0	1.27mm	5.00	6.20	7.00	Separator
IC51-0162-658	16	4.4	1.27mm	4.50	5.70	7.00	Separator
IC51-0162-778	16	4.4	0.65mm	4.60	5.60	6.40	Separator
IC51-0162-902-2	16	5.3	1.27mm	5.35	7.20	8.20	Separator
IC51-0162-911	16	4.4	0.65mm	4.50	5.60	6.40	Floating Base
IC51-0162-1025	16	5.2	1.27mm	5.25	7.20	7.90	Floating Base
IC51-0162-1035	16	4.0	1.27mm	4.20	5.40	6.00	Separator
IC51-0162-1042	16	4.0	1.27mm	4.20	5.40	6.00	Separator
IC51-0202-164	20	5.5	1.27mm	5.70	6.90	8.50	Separator
IC51-0202-347	20	7.7	1.27mm	7.70	9.50	10.30	Separator
IC51-0202-714	20	7.6	1.27mm	7.60	9.30	10.30	Floating Base
IC51-0202-779	20	4.4	0.65mm	4.60	5.60	6.40	Floating Base
IC51-0202-912	20	4.6	0.65mm	4.60	5.60	6.40	Floating Base
IC51-0202-1026	20	5.2	1.27mm	5.25	7.20	7.90	Floating Base
IC51-0262-1339(20)	20	7.6	1.27mm	7.60	8.40	9.20	Floating Base
IC51-0222-803	22	5.5	1.27mm	5.50	6.40	7.10	Separator
IC51-0242-269-1	24	9.4	1.27mm	9.40	10.90	11.70	Separator
IC51-0242-270-1	24	9.4	1.27mm	9.40	11.90	12.70	Separator
IC51-0242-270-3	24	8.0	1.27mm	8.00	11.90	12.70	Separator
IC51-0242-303-1	24	5.3	1.27mm	5.35	7.30	8.00	Separator
IC51-0242-308	24	5.3	0.8mm	5.40	7.20	7.80	Floating Base
IC51-0242-310-1	24	4.5	1.0mm	4.55	5.20	6.40	Separator
IC51-0242-367-1	24	9.4	1.27mm	9.40	10.43	11.20	Separator
IC51-0242-577	24	7.8	0.8mm	7.85	9.30	10.00	Separator
IC51-0242-761	24	5.6	0.65mm	5.80	6.70	7.60	Separator
IC51-0242-793	24	5.5	1.27mm	5.50	7.10	8.00	Separator
IC51-0242-847	24	5.3	1.27mm	5.30	5.90	6.90	Separator
IC51-0242-913	24	5.6	0.65mm	5.70	6.70	7.60	Floating Base
IC51-0242-980	24	5.2	1.27mm	5.25	7.20	7.90	Floating Base
IC51-0242-1006-1	24	14.4	0.5mm	14.40	15.20	16.00	Floating Base
IC51-0262-1339	26	7.6	1.27mm	7.60	8.40	9.20	Floating Base
IC51-0282-153	28	8.7	1.27mm	8.70	10.00	12.00	Separator
IC51-0282-165	28	7.4	1.27mm	7.40	8.70	9.40	Separator
IC51-0282-334-1	28	7.5	1.27mm	7.50	9.40	10.30	Separator
IC51-0282-474	28	8.4	1.27mm	8.45	11.10	12.00	Separator
IC51-0282-673-1	28	11.8	0.55mm	11.80	12.60	13.40	Floating Base
IC51-0282-986	28	7.6	1.27mm	7.60	9.60	10.30	Floating Base
IC51-0282-1032-1	28	12.4	0.5mm	12.40	13.30	14.00	Floating Base
IC51-0302-371-1	30	7.8	1.27mm	7.80	9.60	10.30	Separator
IC51-0302-371-2	30	8.0	1.27mm	8.00	9.20	10.30	Separator

**Note:** Sockets with "separator" can accept and properly align lower pin count devices. Sockets with "Floating Base" will only accept devices with the same pin count as the socket.

# SOP, SSOP, TSOP

## IC51 Series

Part Number	No. of Leads	Body Width	Matching Package				Notes
			Pitch	A (Max)	B (Max)	C (Nominal)	
IC51-0302-755	30	5.8	0.65mm	5.80	6.70	7.60	Separator
IC51-0302-904	30	7.8	1.27mm	7.80	9.20	10.30	Separator
IC51-0302-914	30	5.7	0.65mm	5.70	6.70	7.60	Floating Base
IC51-0302-1017	30	7.6	1.27mm	7.60	9.60	10.30	Floating Base
IC51-0322-883-1	32	13.7	0.5mm	13.73	14.50	16.00	Floating Base
IC51-0322-1031-1	32	12.5	0.5mm	12.50	13.30	14.00	Floating Base
IC51-0322-1207-1	33	18.4	0.5mm	18.43	19.30	20.00	Floating Base
IC51-0322-1219	32	14.4	0.5mm	14.43	15.25	16.00	Floating Base
IC51-0322-2161	32	11.8	0.5mm	11.80	12.70	13.00	Floating Base
IC51-0322-304-2	32	8.4	1.27mm	8.45	11.00	12.00	Separator
IC51-0322-667-2	32	11.6	1.27mm	11.60	13.20	14.00	Separator
IC51-0322-910	32	13.8	0.60mm	13.83	14.60	14.40	Floating Base
IC51-0322-937	32	8.9	1.27mm	8.90	10.90	12.00	Separator
IC51-0322-948	32	8.2	1.00mm	8.20	10.50	12.00	Separator
IC51-0322-950	32	11.3	1.27mm	11.30	13.00	15.00	Floating Base
IC51-0342-741	34	7.8	1.00mm	7.80	7.80	9.40	Separator
IC51-0362-309	36	8.5	0.80mm	8.50	11.00	12.60	Floating Base
IC51-0402-708	40	8.8	0.80mm	8.80	10.60	12.00	Separator
IC51-0402-991	40	11.6	1.27mm	11.60	13.00	14.00	Separator
IC51-0402-1174-1	40	18.4	0.50mm	18.80	19.30	20.00	Floating Base
IC51-0402-1197	40	10.9	1.27mm	10.90	12.90	14.00	Separator
IC51-0402-1557	40	12.4	0.50mm	12.43	13.40	14.00	Floating Base
IC51-0422-393	42	8.5	0.80mm	8.50	11.00	12.00	Separator
IC51-0442-1208	44	12.8	1.27mm	12.80	14.70	15.90	Separator
IC51-0442-1315	44	13.0	1.27mm	13.00	15.00	15.80	Floating Base
IC51-0442-1536	44	13.4	1.27mm	13.60	14.70	16.00	Separator
IC51-0442-1709	44	10.2	0.80mm	10.43	11.00	11.76	Separator (50/44)
IC51-0482-1009	48	13.7	0.80mm	13.70	14.90	16.00	Floating Base
IC51-0482-1099-1	48	16.4	0.50mm	16.43	17.60	18.20	Floating Base
IC51-0482-1009-2	48	13.7	0.80mm	13.70	15.10	16.00	Floating Base
IC51-0482-2019	48	18.4	0.50mm	18.40	19.40	20.60	Floating Base
IC51-0502-1708	50	10.2	0.8mm	10.43	11.00	11.76	Separator
IC51-0562-1387	56	7.7	0.635mm	7.70	9.40	10.30	Separator
IC51-0702-1965	70	12.8	0.8mm	12.80	14.86	15.90	Separator
IC51-0722-1955	72	11.0	0.65mm	11.00	12.30	13.00	

Note: Sockets with "separator" can accept and properly align lower pin count devices. Sockets with "Floating Base" will only accept devices with the same pin count as the socket.

## TSOP Carrier Style Type II

Part Number	No. of Leads	Body Width	Matching Package				Carrier
			Pitch	A (Max)	B (Max)	C (Nominal)	
* IC53-536.KS-10619	20	7.6 (300 Mil)	1.27mm	7.6	8.4	9.2	ICC-20-12
IC53-0262-536	26	7.6 (300 Mil)	1.27mm	7.6	8.4	9.2	ICC-20-13
* IC53-616.KS-11998	40	10.1 (400 Mil)	0.8mm	10.2	10.9	11.8	IC-44-5
IC53-0442-616	44	10.1 (400 Mil)	0.8mm	10.2	10.9	11.8	IC-44-5

Note: Sockets with "separator" can accept and properly align lower pin count devices. Sockets with "Floating Base" will only accept devices with the same pin count as the socket.

\* Depopulated Version

# PC BOARD LAYOUTS

SOP

## IC51 Series

SOP IC51-1035.KS-15187 (14 Pins)

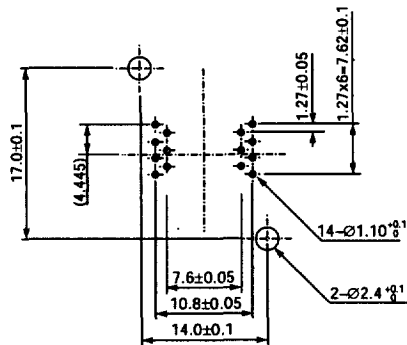

SOP IC51-0202-164 (20 Pins)

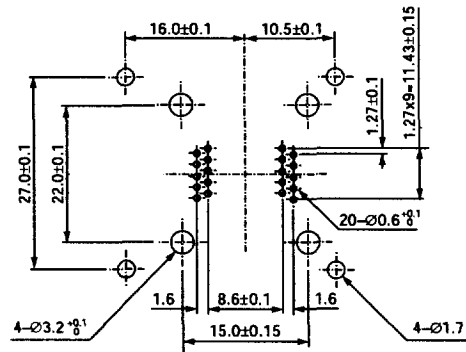

SOP IC51-0162-1035 (16 Pins)

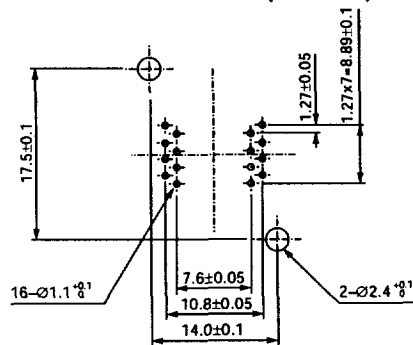

SOP IC51-0322-950 (32 Pins)

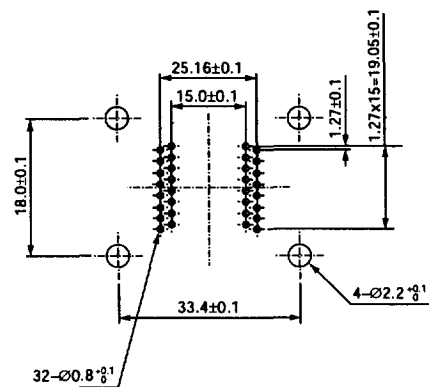

# SOP

# IC51 Series

# PC BOARD LAYOUTS

SOP IC51-0082-1024 (8 Pins)

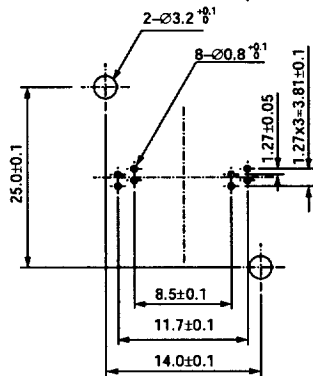

SOP IC51-0142-951 (14 Pins)

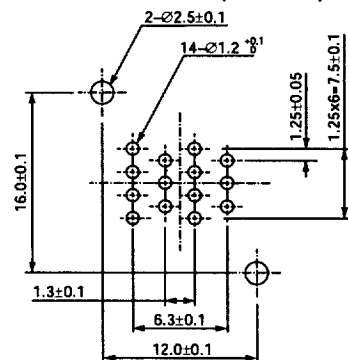

SOP IC51-0102-987 (10 Pins)

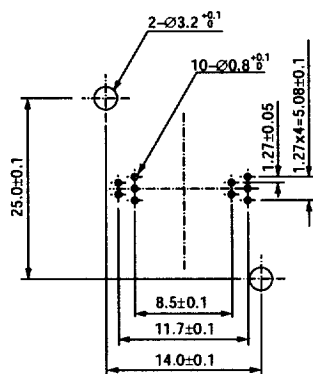

SOP IC51-0162-1042 (16 Pins)

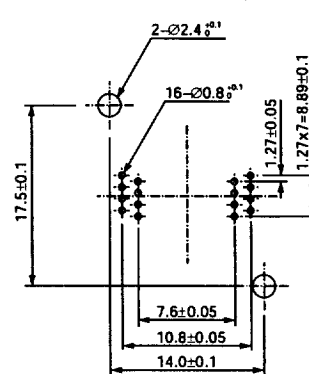

SOP IC51-0142-1013 (14 Pins)

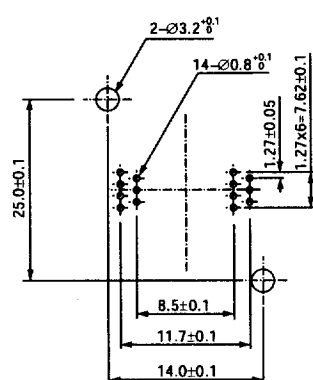

SOP IC51-0162-658 (16 Pins)

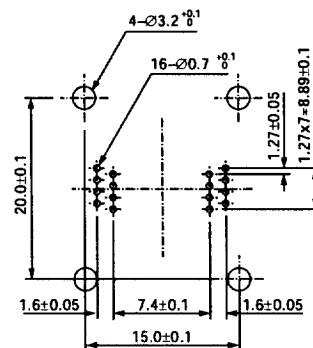

# PC BOARD LAYOUTS

# SOP

# IC51 Series

SOP IC51-0162-271-2 (16 Pins)

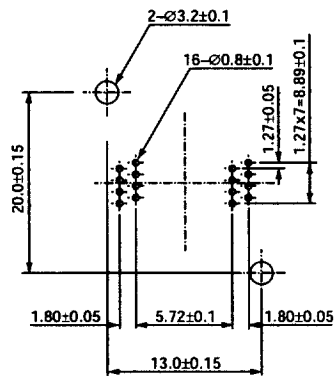

SOP IC51-0162-902-2 (16 Pins)

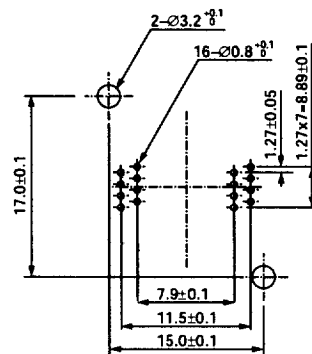

SOP IC51-0162-273-2 (16 Pins)

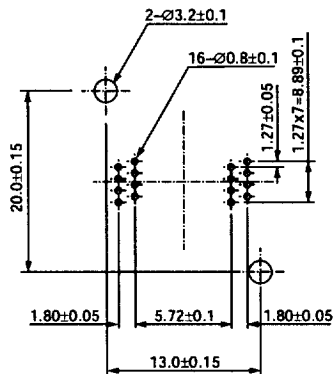

SOP IC51-0162-271-1 (16 Pins)

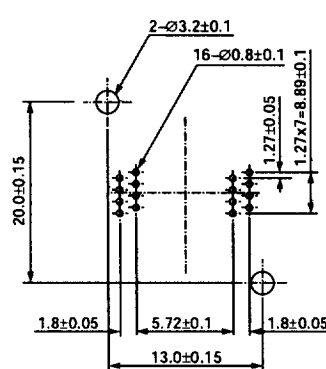

SOP IC51-0162-1025 (16 Pins)

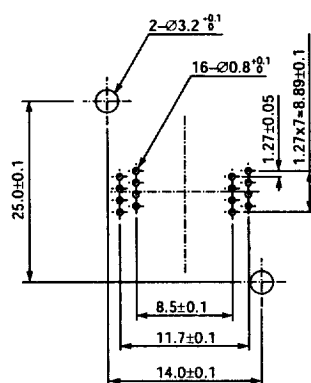

# SOP

# IC51 Series

# PC BOARD LAYOUTS

SOP IC51-0202-714 (20 Pins)

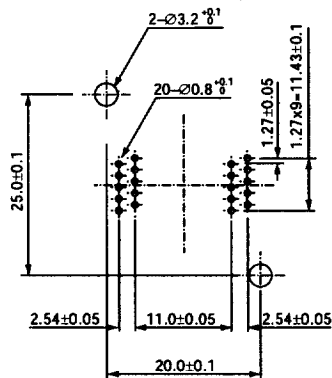

SOP IC51-347.KS-6768 (18 Pins)

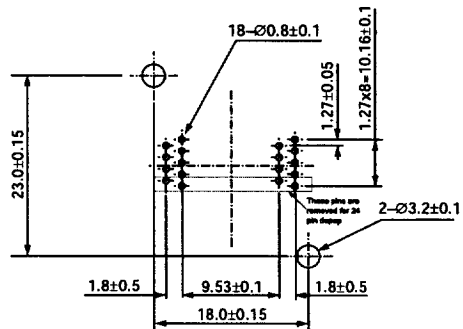

SOP IC51-0202-1026 (20 Pins)

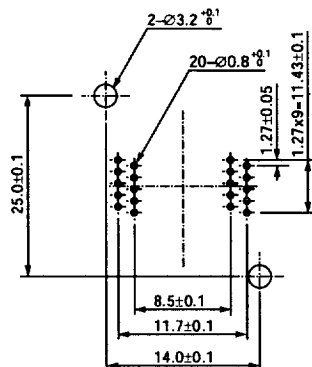

SOP IC51-0202-347 (20 Pins)

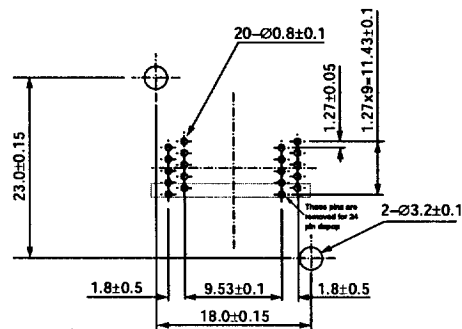

SOP IC51-347.KS-7704 (16 Pins)

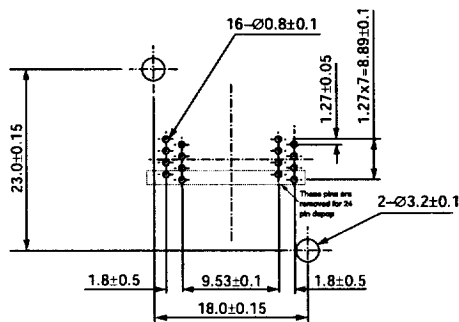

# PC BOARD LAYOUTS

SOP

# IC51 Series

SOP IC51-0242-577 (24 Pins)

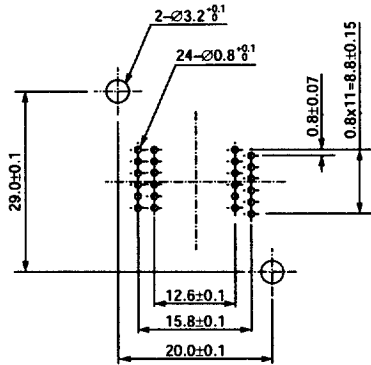

SOP IC51-0242-793 (24 Pins)

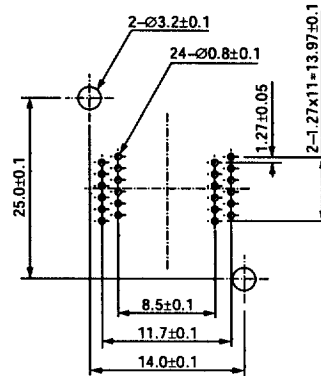

SOP IC51-0242-310-1 (24 Pins)

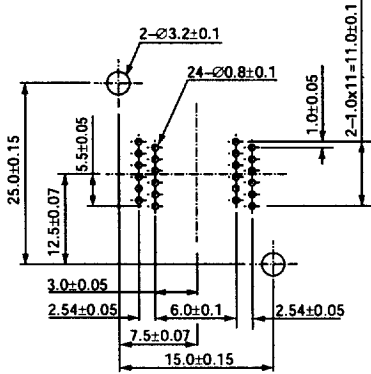

SOP IC51-0242-269-1 (24 Pins)

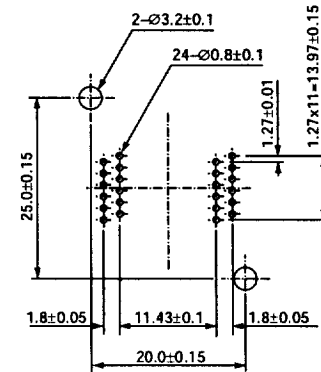

SOP IC51-0242-303-1 (24 Pins)

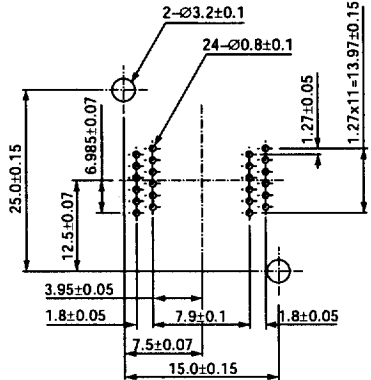



# SOP

# IC51 Series

# PC BOARD LAYOUTS

SOP IC51-0242-269-2 (24 Pins)

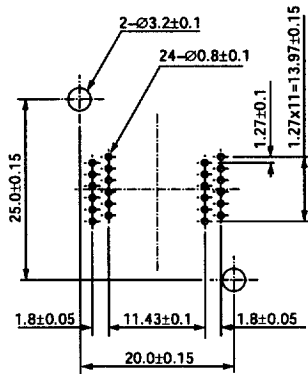

SOP IC51-0242-367-1 (24 Pins)

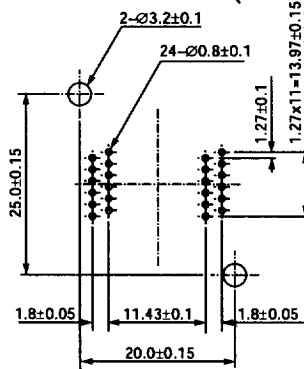

SOP IC51-0242-980 (24 Pins)

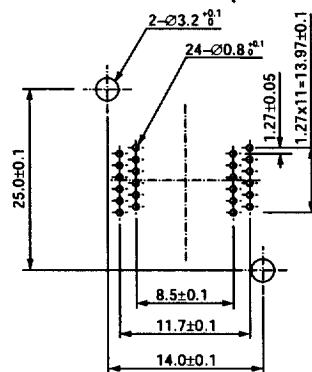

SOP IC51-0242-270-1 (24 Pins)

SOP IC51-0242-270-2 (24 Pins)

SOP IC51-0242-270-3 (24 Pins)

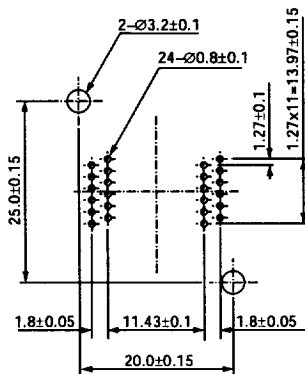

SOP IC51-0262-1339 (26 Pins)

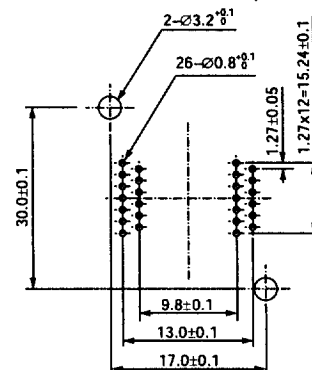

# PC BOARD LAYOUTS

# SOP

## IC51 Series

SOP IC51-0282-165 (28 Pins)

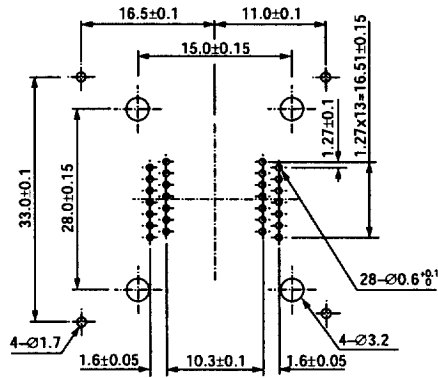

SOP IC51-0282-474 (28 Pins)

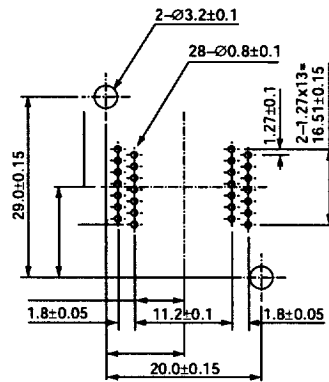

SOP IC51-334-1.KS-6411 (24 Pins)  
SOP IC51-0282-334-1 (28 Pins)

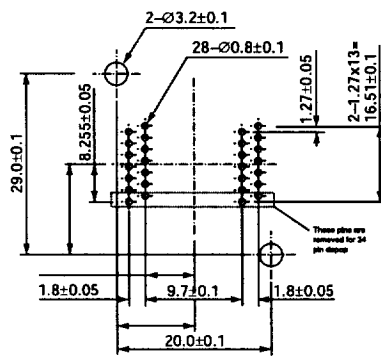

SOP IC51-0302-904 (30 Pins)

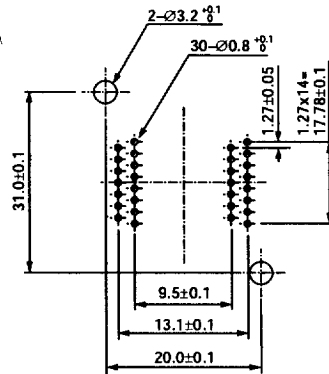

SOP IC51-0282-986 (28 Pins)

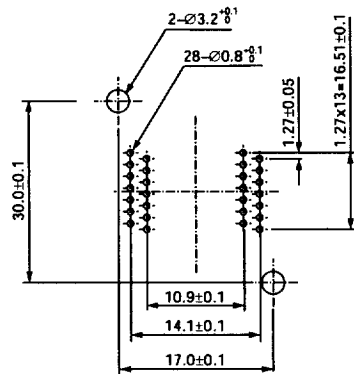

SOP IC51-0302-1017 (30 Pins)

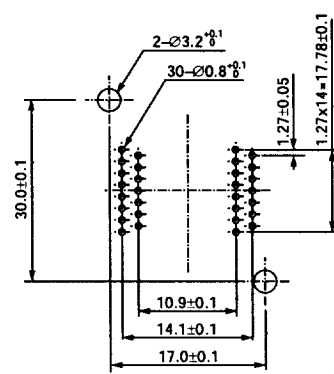

# SOP

## IC51 Series

# PC BOARD LAYOUTS

SOP IC51-0302-371-2 (30 Pins)

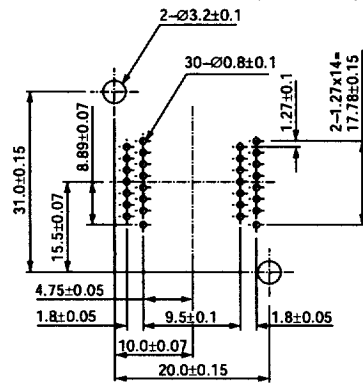

SOP IC51-0322-667-2 (32 Pins)

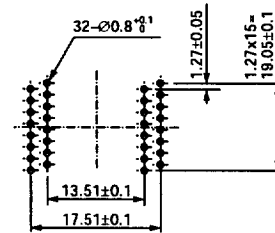

SOP IC51-0322-304-2 (32 Pins)

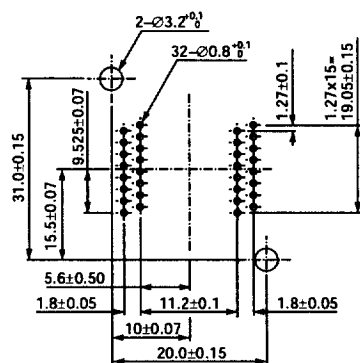

SOP IC51-0362-309 (36 Pins)

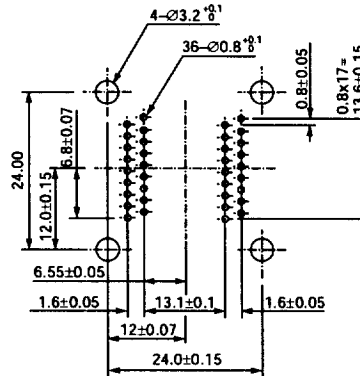

SOP IC51-0322-937 (32 Pins)

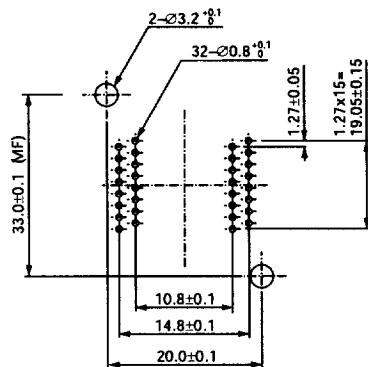

# PC BOARD LAYOUTS

# SOP

## IC51 Series

SOP IC51-0402-708 (40 Pins)

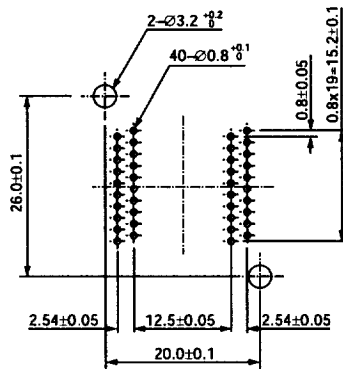

SOP IC51-0422-393 (42 Pins)

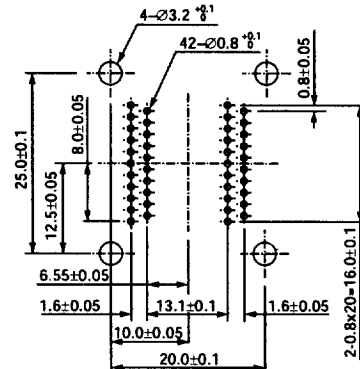

SOP IC51-0402-1197 (40 Pins)

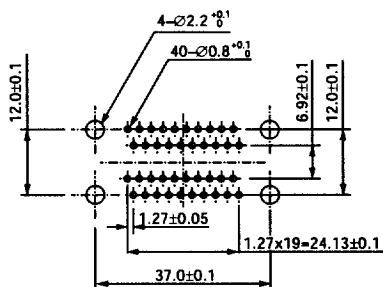

SOP IC51-0442-1208 (44 Pins)

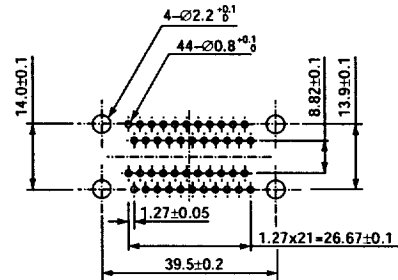

SOP IC51-0402-991 (40 Pins)

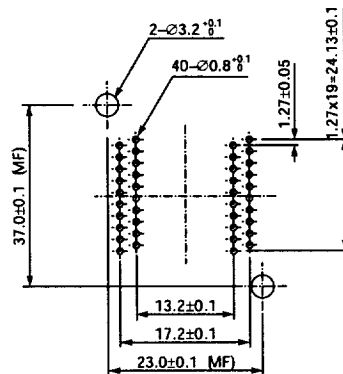

SOP IC51-0442-1315 (44 Pins)

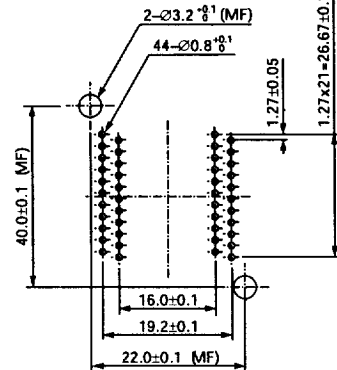

# SOP, SSOP

# IC51 Series

# PC BOARD LAYOUTS

SOP IC51-0442-1536 (44 Pins)

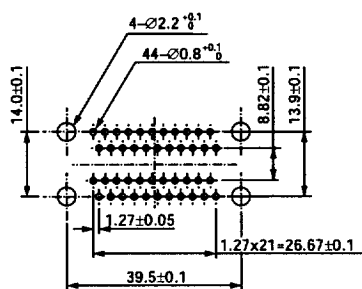

SSOP IC51-0202-779 (20 Pins)

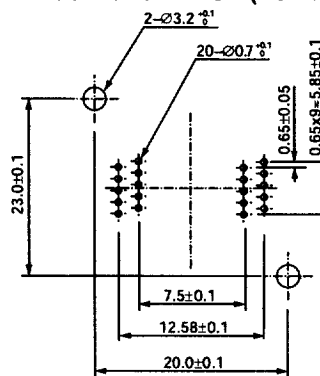

SOP IC51-0482-1009-2 (48 Pins)

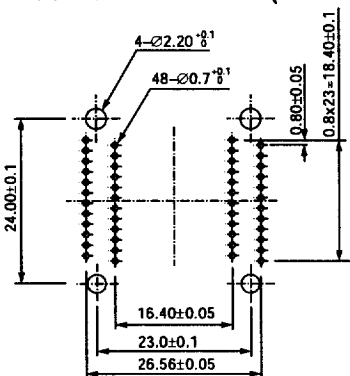

SSOP IC51-0202-912 (20 Pins)

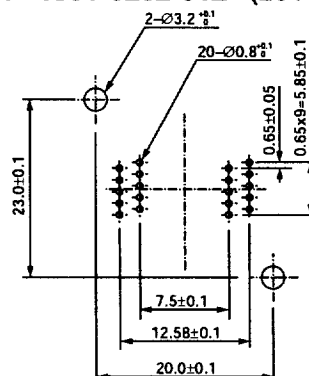

SSOP IC51-0162-911 (16 Pins)

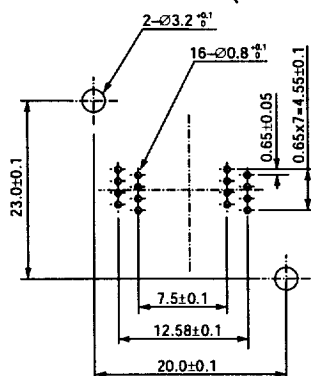

SSOP IC51-0242-913 (24 Pins)

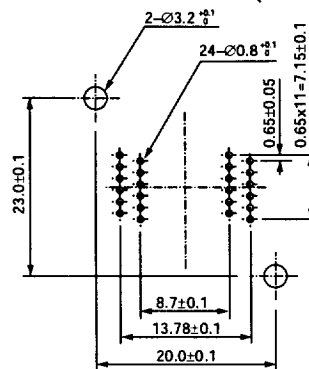

# PC BOARD LAYOUTS

# SSOP

## IC51 Series

SSOP IC51-0242-761 (24 Pins)

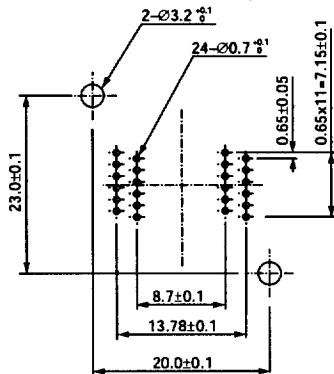

SSOP IC51-0302-914 (30 Pins)

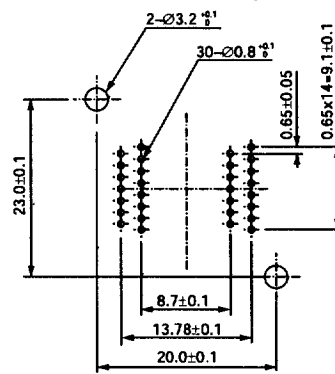

SSOP IC51-0282-673-1 (28 Pins)

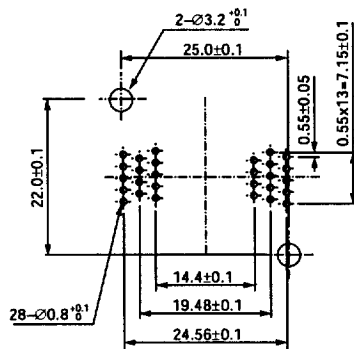

SSOP IC51-0302-755 (30 Pins)

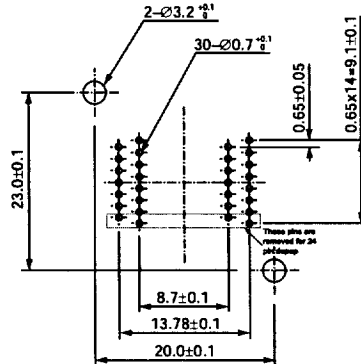

SSOP IC51-755.KS-13330 (28 Pins)

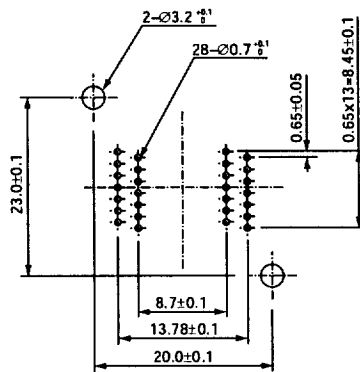

SSOP IC51-0322-910 (32 Pins)

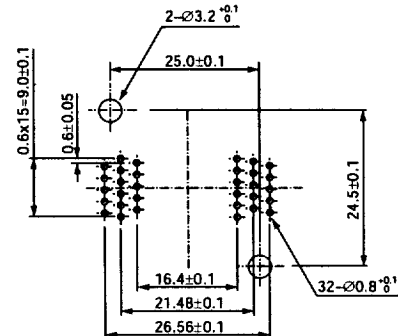

# SSOP, TSOP

# IC51 Series

# PC BOARD LAYOUTS

SSOP IC51-1387.KS-15186 (48 Pins)\*  
SSOP IC51-0562-1387 (56 Pins)

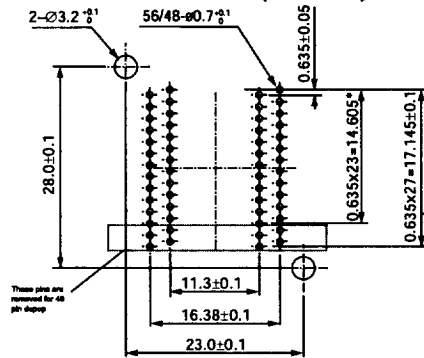

TSOP IC51-0322-1031-1 (32 Pins)

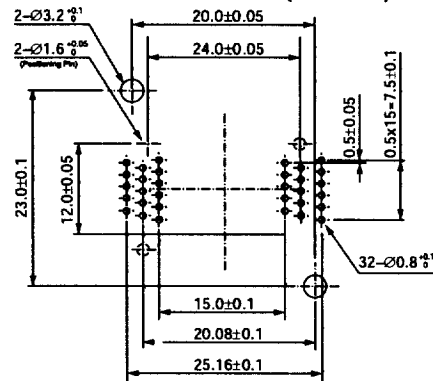

TSOP IC51-0242-1006-1 (24 Pins)

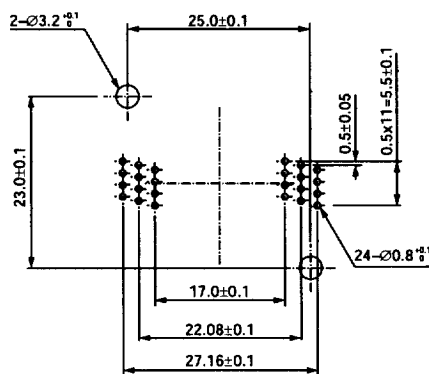

TSOP IC51-0322-883-1 (32 Pins)

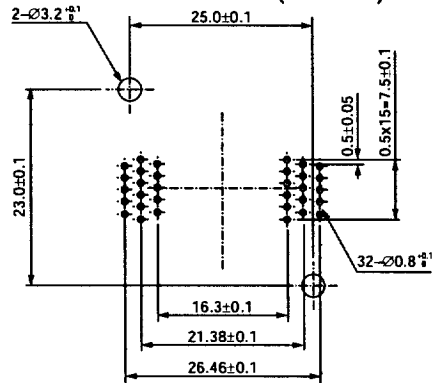

TSOP IC51-0282-1032-1 (28 Pins)

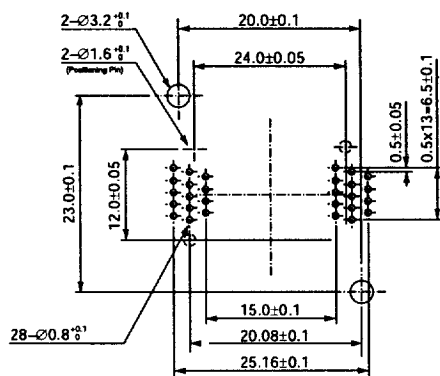

TSOP IC51-0322-1219 (32 Pins)

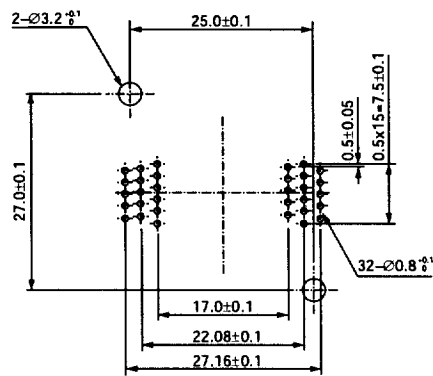

# PC BOARD LAYOUTS

# TSOP

# IC51 Series

**TSOP IC51-0322-1207-1 (32 Pins)**

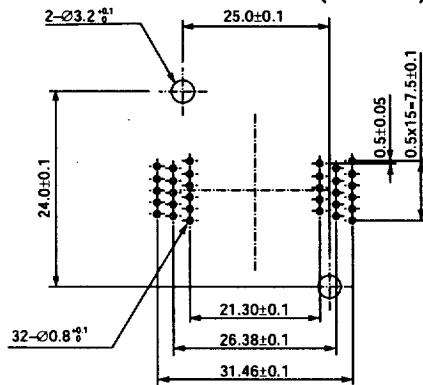

**TSOP IC51-0482-1099 (48 Pins)**

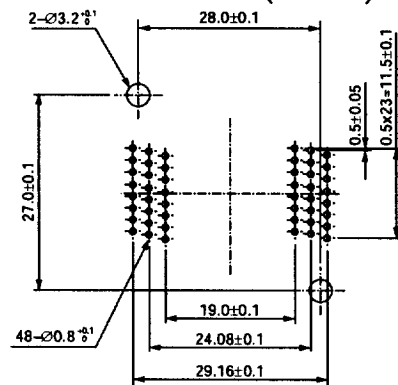

**TSOP IC51-0402-1557 (40 Pins)**

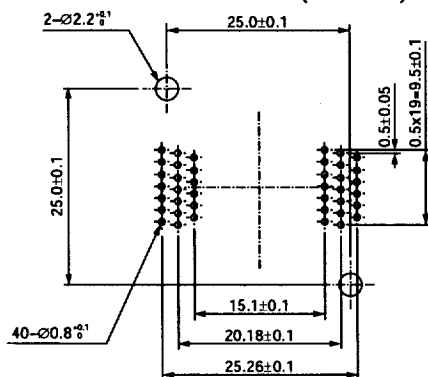

**TSOP IC51-0482-2018 (48 Pins)**

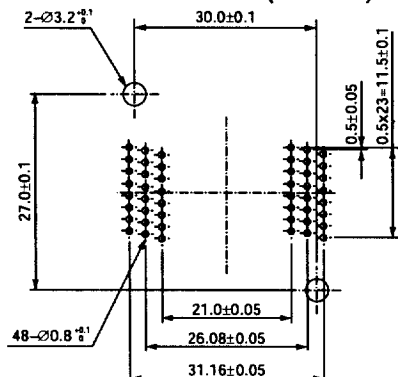

**TSOP IC51-0402-1174-1 (40 Pins)**

