

SOP, SSOP, TSOP

IC51 Series

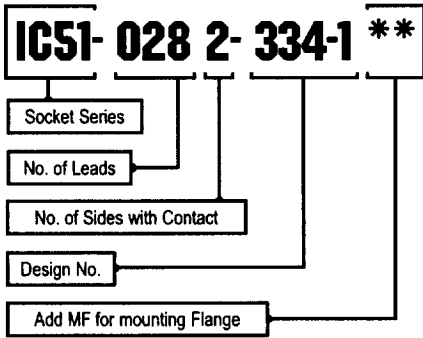
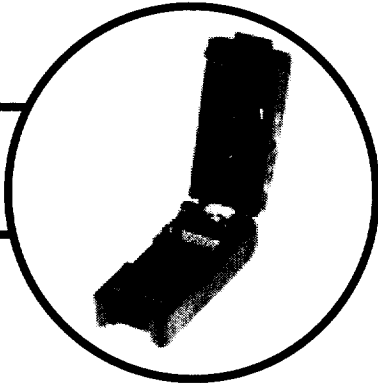

Insulation Resistance:
Withstanding Voltage:
Contact Resistance:
Operating Temperature:

Characteristics
1,000M Ω minimum at 500 VDC
700 VAC for 1 Minute
30m Ω max. at 10mA/20mV (Initial)
-40°C ~ +150°C

Insulator:
Contact:
Plating:

Material
PES / PEI (Glass Filled)
Beryllium Copper
Gold over Nickel

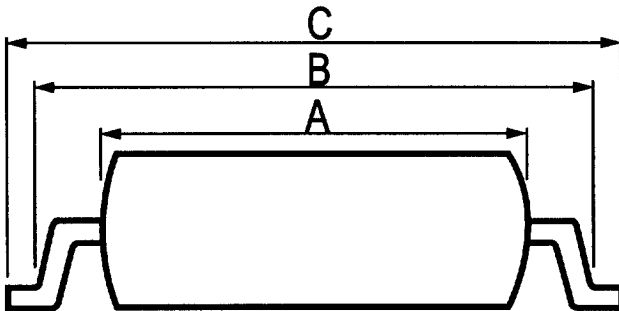

A: Body Width
B: Inside of Flat Portion
C: Tip to Tip

Part Number	No. of Leads	Body Width	Pitch	Matching Package			Notes
				A (Max)	B (Max)	C (Nominal)	
IC51-0082-1024	8	5.2	1.27mm	5.3	7.2	7.9	Floating Base
IC51-0102-987	10	5.2	1.27mm	5.3	7.2	7.9	Floating Base
IC51-0142-084	14	4.5	1.27mm	4.5	5.7	6.0	Separator
IC51-0142-189	14	7.0	1.27mm	7.0	8.9	10.0	Separator
IC51-0142-951	14	4.4	1.25mm	4.5	5.2	6.0	Separator
IC51-0142-1013	14	5.2	1.27mm	5.3	7.2	7.9	Floating Base

Note: Sockets with "separator" can accept and properly align lower pin count devices. Sockets with "Floating Base" will only accept devices with the same pin count as the socket.

SOP, SSOP, TSOP

IC51 Series

Part Number	No. of Leads	Body Width	Matching Package				Notes
			Pitch	A (Max)	B (Max)	C (Nominal)	
IC51-0122-1836	12	4.4	0.80mm	4.40	5.90	6.40	Separator
IC51-0162-109	16	5.2	1.27mm	5.20	6.00	7.20	Separator
IC51-0162-163	16	4.5	1.27mm	4.50	5.70	6.00	Separator
IC51-0162-225	16	4.4	1.27mm	4.40	5.40	6.00	Separator
IC51-0162-271-1	16	5.5	1.27mm	5.50	5.20	6.00	Separator
IC51-0162-271-2	16	5.0	1.27mm	5.00	5.20	6.00	Separator
IC51-0162-272-1	16	5.5	1.27mm	5.50	5.70	6.50	Separator
IC51-0162-273-1	16	5.5	1.27mm	5.50	6.22	7.00	Separator
IC51-0162-273-2	16	5.0	1.27mm	5.00	6.20	7.00	Separator
IC51-0162-658	16	4.4	1.27mm	4.50	5.70	7.00	Separator
IC51-0162-778	16	4.4	0.65mm	4.60	5.60	6.40	Separator
IC51-0162-902-2	16	5.3	1.27mm	5.35	7.20	8.20	Separator
IC51-0162-911	16	4.4	0.65mm	4.50	5.60	6.40	Floating Base
IC51-0162-1025	16	5.2	1.27mm	5.25	7.20	7.90	Floating Base
IC51-0162-1035	16	4.0	1.27mm	4.20	5.40	6.00	Separator
IC51-0162-1042	16	4.0	1.27mm	4.20	5.40	6.00	Separator
IC51-0202-164	20	5.5	1.27mm	5.70	6.90	8.50	Separator
IC51-0202-347	20	7.7	1.27mm	7.70	9.50	10.30	Separator
IC51-0202-714	20	7.6	1.27mm	7.60	9.30	10.30	Floating Base
IC51-0202-779	20	4.4	0.65mm	4.60	5.60	6.40	Floating Base
IC51-0202-912	20	4.6	0.65mm	4.60	5.60	6.40	Floating Base
IC51-0202-1026	20	5.2	1.27mm	5.25	7.20	7.90	Floating Base
IC51-0262-1339(20)	20	7.6	1.27mm	7.60	8.40	9.20	Floating Base
IC51-0222-803	22	5.5	1.27mm	5.50	6.40	7.10	Separator
IC51-0242-269-1	24	9.4	1.27mm	9.40	10.90	11.70	Separator
IC51-0242-270-1	24	9.4	1.27mm	9.40	11.90	12.70	Separator
IC51-0242-270-3	24	8.0	1.27mm	8.00	11.90	12.70	Separator
IC51-0242-303-1	24	5.3	1.27mm	5.35	7.30	8.00	Separator
IC51-0242-308	24	5.3	0.8mm	5.40	7.20	7.80	Floating Base
IC51-0242-310-1	24	4.5	1.0mm	4.55	5.20	6.40	Separator
IC51-0242-367-1	24	9.4	1.27mm	9.40	10.43	11.20	Separator
IC51-0242-577	24	7.8	0.8mm	7.85	9.30	10.00	Separator
IC51-0242-761	24	5.6	0.65mm	5.80	6.70	7.60	Separator
IC51-0242-793	24	5.5	1.27mm	5.50	7.10	8.00	Separator
IC51-0242-847	24	5.3	1.27mm	5.30	5.90	6.90	Separator
IC51-0242-913	24	5.6	0.65mm	5.70	6.70	7.60	Floating Base
IC51-0242-980	24	5.2	1.27mm	5.25	7.20	7.90	Floating Base
IC51-0242-1006-1	24	14.4	0.5mm	14.40	15.20	16.00	Floating Base
IC51-0262-1339	26	7.6	1.27mm	7.60	8.40	9.20	Floating Base
IC51-0282-153	28	8.7	1.27mm	8.70	10.00	12.00	Separator
IC51-0282-165	28	7.4	1.27mm	7.40	8.70	9.40	Separator
IC51-0282-334-1	28	7.5	1.27mm	7.50	9.40	10.30	Separator
IC51-0282-474	28	8.4	1.27mm	8.45	11.10	12.00	Separator
IC51-0282-673-1	28	11.8	0.55mm	11.80	12.60	13.40	Floating Base
IC51-0282-986	28	7.6	1.27mm	7.60	9.60	10.30	Floating Base
IC51-0282-1032-1	28	12.4	0.5mm	12.40	13.30	14.00	Floating Base
IC51-0302-371-1	30	7.8	1.27mm	7.80	9.60	10.30	Separator
IC51-0302-371-2	30	8.0	1.27mm	8.00	9.20	10.30	Separator

Note: Sockets with "separator" can accept and properly align lower pin count devices. Sockets with "Floating Base" will only accept devices with the same pin count as the socket.

SOP, SSOP, TSOP

IC51 Series

Part Number	No. of Leads	Body Width	Matching Package				Notes
			Pitch	A (Max)	B (Max)	C (Nominal)	
IC51-0302-755	30	5.8	0.65mm	5.80	6.70	7.60	Separator
IC51-0302-904	30	7.8	1.27mm	7.80	9.20	10.30	Separator
IC51-0302-914	30	5.7	0.65mm	5.70	6.70	7.60	Floating Base
IC51-0302-1017	30	7.6	1.27mm	7.60	9.60	10.30	Floating Base
IC51-0322-883-1	32	13.7	0.5mm	13.73	14.50	16.00	Floating Base
IC51-0322-1031-1	32	12.5	0.5mm	12.50	13.30	14.00	Floating Base
IC51-0322-1207-1	33	18.4	0.5mm	18.43	19.30	20.00	Floating Base
IC51-0322-1219	32	14.4	0.5mm	14.43	15.25	16.00	Floating Base
IC51-0322-2161	32	11.8	0.5mm	11.80	12.70	13.00	Floating Base
IC51-0322-304-2	32	8.4	1.27mm	8.45	11.00	12.00	Separator
IC51-0322-667-2	32	11.6	1.27mm	11.60	13.20	14.00	Separator
IC51-0322-910	32	13.8	0.60mm	13.83	14.60	14.40	Floating Base
IC51-0322-937	32	8.9	1.27mm	8.90	10.90	12.00	Separator
IC51-0322-948	32	8.2	1.00mm	8.20	10.50	12.00	Separator
IC51-0322-950	32	11.3	1.27mm	11.30	13.00	15.00	Floating Base
IC51-0342-741	34	7.8	1.00mm	7.80	7.80	9.40	Separator
IC51-0362-309	36	8.5	0.80mm	8.50	11.00	12.60	Floating Base
IC51-0402-708	40	8.8	0.80mm	8.80	10.60	12.00	Separator
IC51-0402-991	40	11.6	1.27mm	11.60	13.00	14.00	Separator
IC51-0402-1174-1	40	18.4	0.50mm	18.80	19.30	20.00	Floating Base
IC51-0402-1197	40	10.9	1.27mm	10.90	12.90	14.00	Separator
IC51-0402-1557	40	12.4	0.50mm	12.43	13.40	14.00	Floating Base
IC51-0422-393	42	8.5	0.80mm	8.50	11.00	12.00	Separator
IC51-0442-1208	44	12.8	1.27mm	12.80	14.70	15.90	Separator
IC51-0442-1315	44	13.0	1.27mm	13.00	15.00	15.80	Floating Base
IC51-0442-1536	44	13.4	1.27mm	13.60	14.70	16.00	Separator
IC51-0442-1709	44	10.2	0.80mm	10.43	11.00	11.76	Separator (50/44)
IC51-0482-1009	48	13.7	0.80mm	13.70	14.90	16.00	Floating Base
IC51-0482-1099-1	48	16.4	0.50mm	16.43	17.60	18.20	Floating Base
IC51-0482-1009-2	48	13.7	0.80mm	13.70	15.10	16.00	Floating Base
IC51-0482-2019	48	18.4	0.50mm	18.40	19.40	20.60	Floating Base
IC51-0502-1708	50	10.2	0.8mm	10.43	11.00	11.76	Separator
IC51-0562-1387	56	7.7	0.635mm	7.70	9.40	10.30	Separator
IC51-0702-1965	70	12.8	0.8mm	12.80	14.86	15.90	Separator
IC51-0722-1955	72	11.0	0.65mm	11.00	12.30	13.00	

Note: Sockets with "separator" can accept and properly align lower pin count devices. Sockets with "Floating Base" will only accept devices with the same pin count as the socket.

TSOP Carrier Style Type II

Part Number	No. of Leads	Body Width	Matching Package				Carrier
			Pitch	A (Max)	B (Max)	C (Nominal)	
* IC53-536.KS-10619	20	7.6 (300 Mil)	1.27mm	7.6	8.4	9.2	ICC-20-12
IC53-0262-536	26	7.6 (300 Mil)	1.27mm	7.6	8.4	9.2	ICC-20-13
* IC53-616.KS-11998	40	10.1 (400 Mil)	0.8mm	10.2	10.9	11.8	IC-44-5
IC53-0442-616	44	10.1 (400 Mil)	0.8mm	10.2	10.9	11.8	IC-44-5

Note: Sockets with "separator" can accept and properly align lower pin count devices. Sockets with "Floating Base" will only accept devices with the same pin count as the socket.

* Depopulated Version

PC BOARD LAYOUTS

SOP

IC51 Series

SOP IC51-1035.KS-15187 (14 Pins)

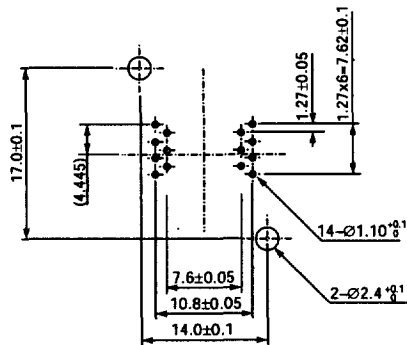

SOP IC51-0202-164 (20 Pins)

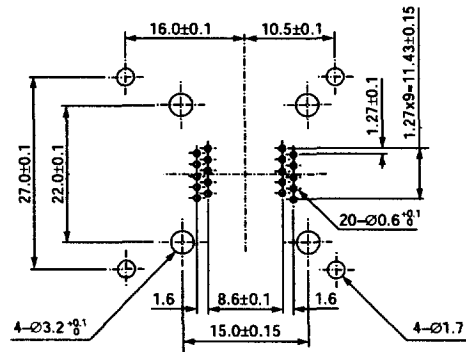

SOP IC51-0162-1035 (16 Pins)

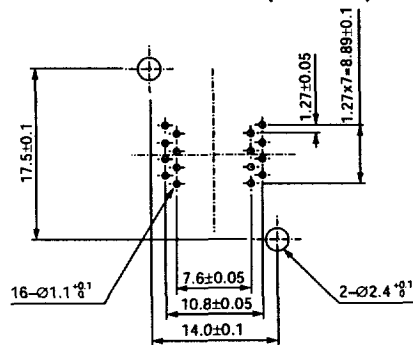

SOP IC51-0322-950 (32 Pins)

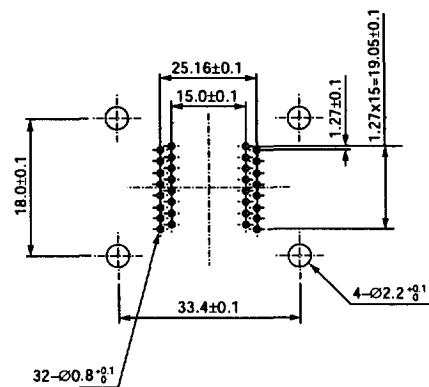

SOP

IC51 Series

PC BOARD LAYOUTS

SOP IC51-0082-1024 (8 Pins)

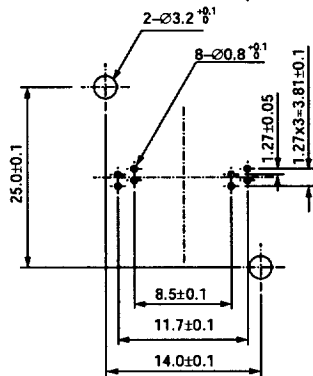

SOP IC51-0142-951 (14 Pins)

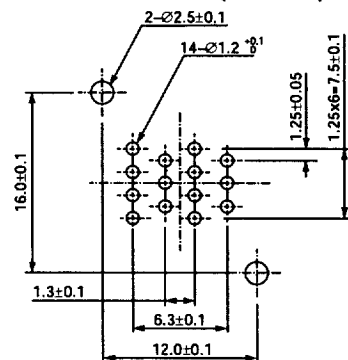

SOP IC51-0102-987 (10 Pins)

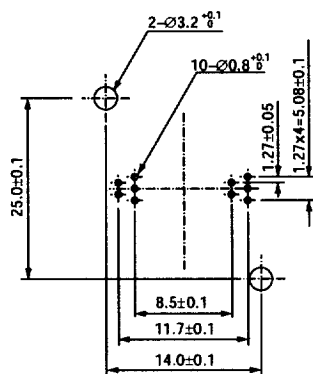

SOP IC51-0162-1042 (16 Pins)

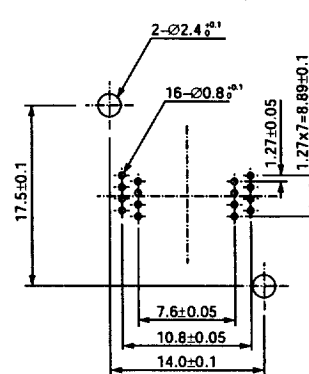

SOP IC51-0142-1013 (14 Pins)

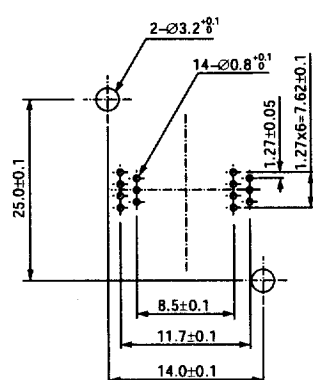

SOP IC51-0162-658 (16 Pins)

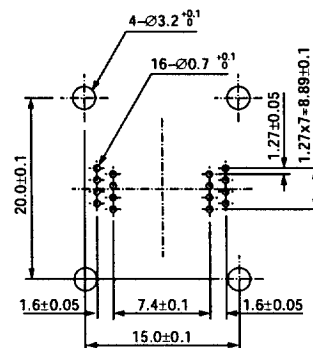

PC BOARD LAYOUTS

SOP

IC51 Series

SOP IC51-0162-271-2 (16 Pins)

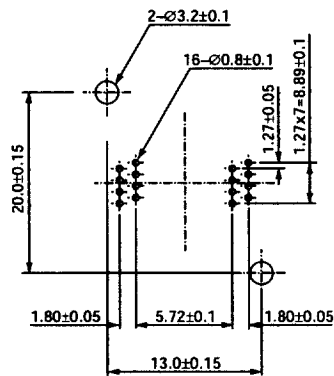

SOP IC51-0162-902-2 (16 Pins)

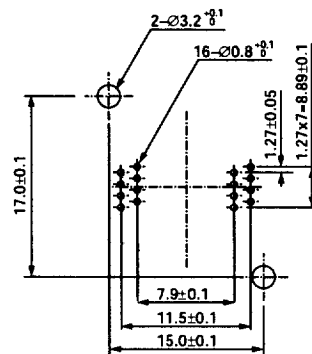

SOP IC51-0162-273-2 (16 Pins)

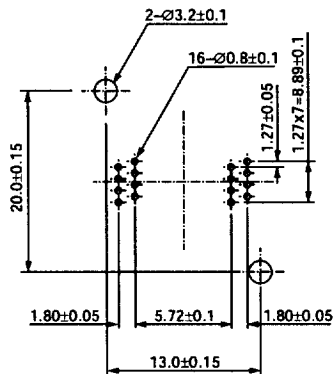

SOP IC51-0162-271-1 (16 Pins)

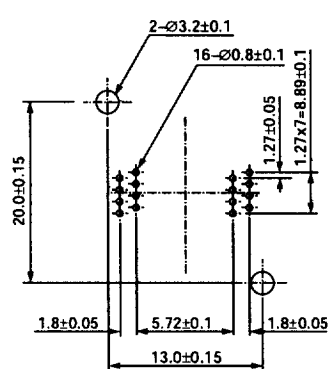

SOP IC51-0162-1025 (16 Pins)

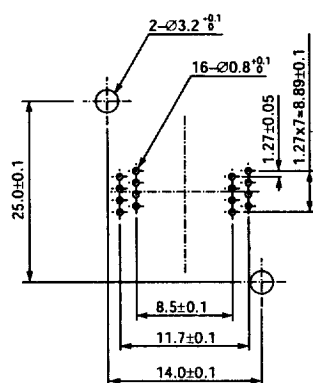

SOP

IC51 Series

PC BOARD LAYOUTS

SOP IC51-0202-714 (20 Pins)

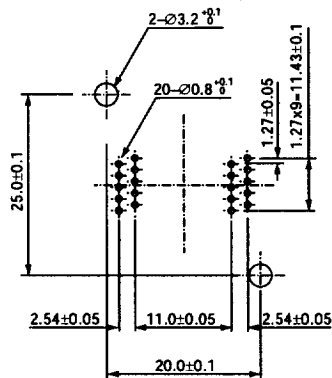

SOP IC51-347.KS-6768 (18 Pins)

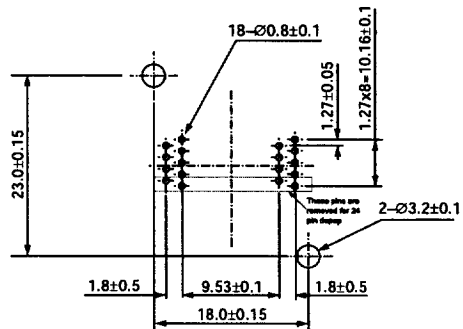

SOP IC51-0202-1026 (20 Pins)

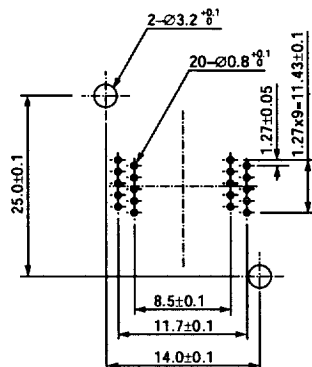

SOP IC51-0202-347 (20 Pins)

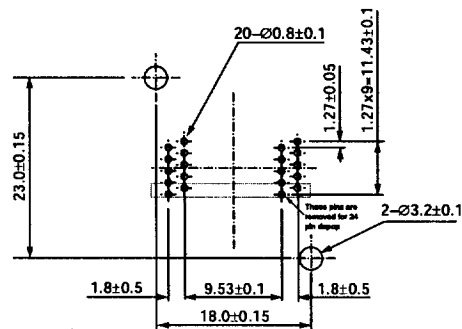

SOP IC51-347.KS-7704 (16 Pins)

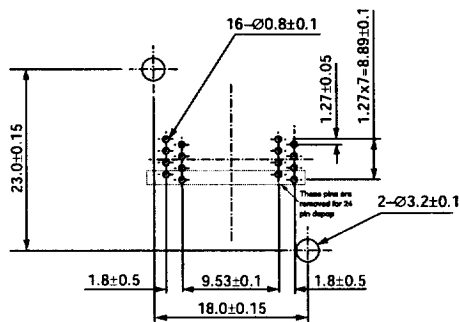

PC BOARD LAYOUTS

SOP

IC51 Series

SOP IC51-0242-577 (24 Pins)

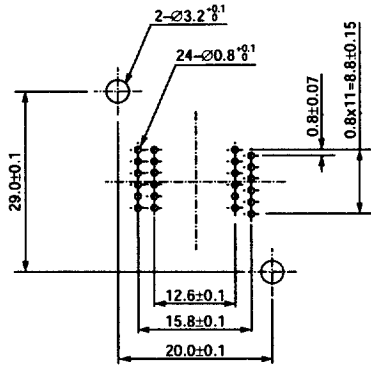

SOP IC51-0242-793 (24 Pins)

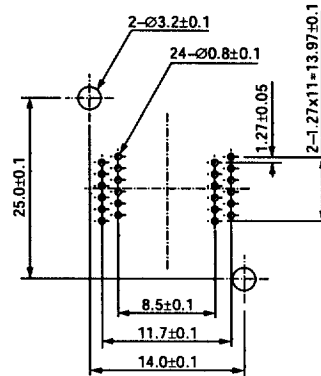

SOP IC51-0242-310-1 (24 Pins)

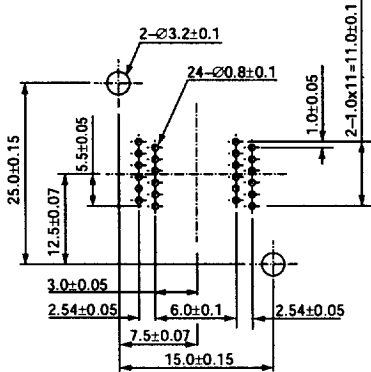

SOP IC51-0242-269-1 (24 Pins)

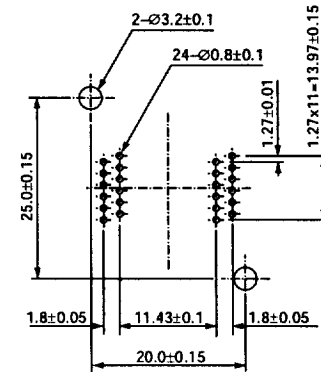

SOP IC51-0242-303-1 (24 Pins)

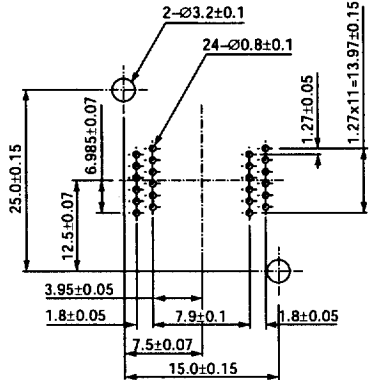

SOP

IC51 Series

PC BOARD LAYOUTS

SOP IC51-0242-269-2 (24 Pins)

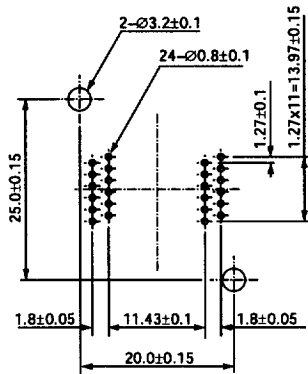

SOP IC51-0242-367-1 (24 Pins)

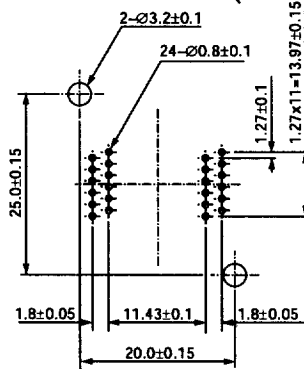

SOP IC51-0242-980 (24 Pins)

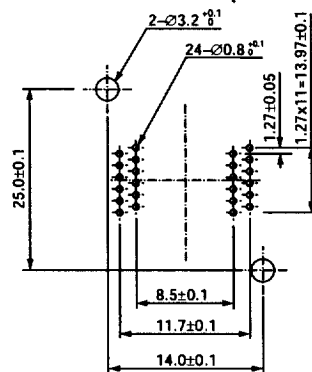

SOP IC51-0242-270-1 (24 Pins)

SOP IC51-0242-270-2 (24 Pins)

SOP IC51-0242-270-3 (24 Pins)

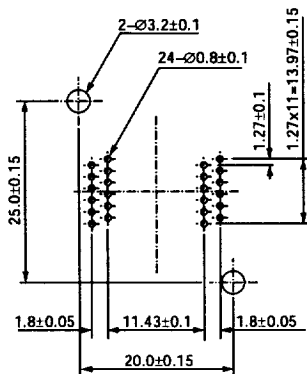

SOP IC51-0262-1339 (26 Pins)

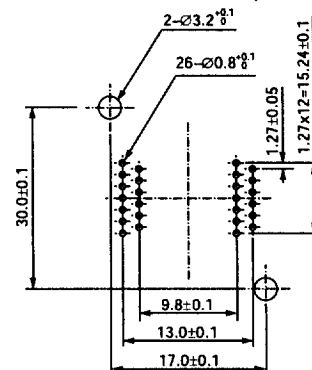

PC BOARD LAYOUTS

SOP

IC51 Series

SOP IC51-0282-165 (28 Pins)

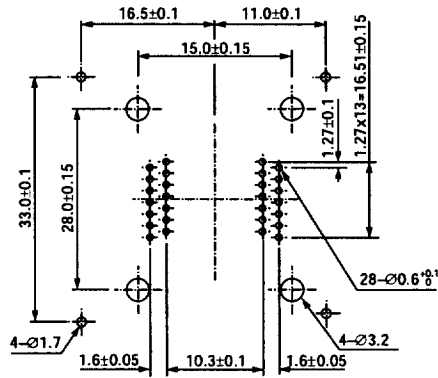

SOP IC51-0282-474 (28 Pins)

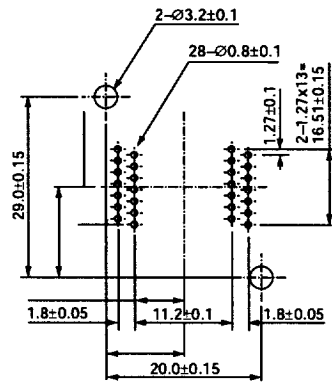

SOP IC51-334-1.KS-6411 (24 Pins)
SOP IC51-0282-334-1 (28 Pins)

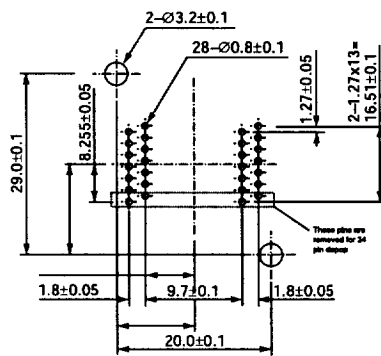

SOP IC51-0302-904 (30 Pins)

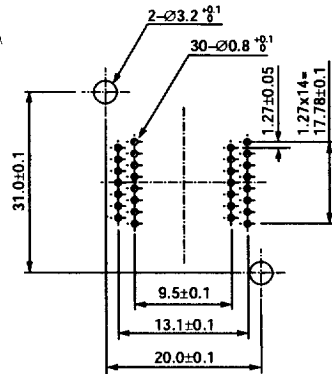

SOP IC51-0282-986 (28 Pins)

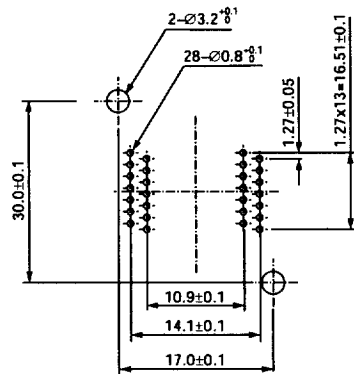

SOP IC51-0302-1017 (30 Pins)

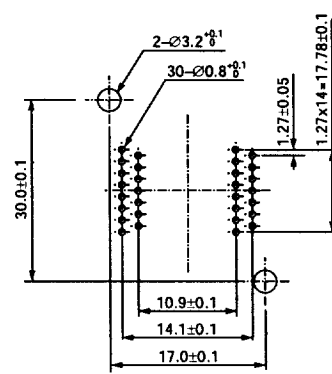

PC BOARD LAYOUTS

SOP

IC51 Series

SOP IC51-0402-708 (40 Pins)

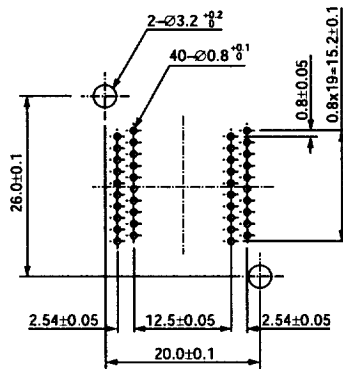

SOP IC51-0422-393 (42 Pins)

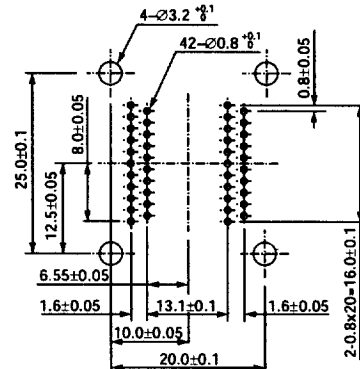

SOP IC51-0402-1197 (40 Pins)

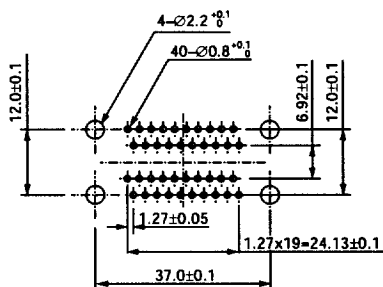

SOP IC51-0442-1208 (44 Pins)

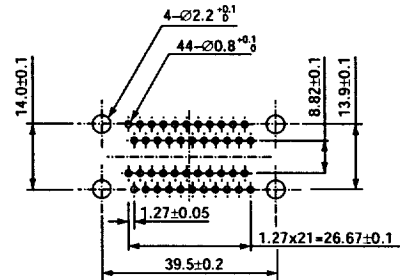

SOP IC51-0402-991 (40 Pins)

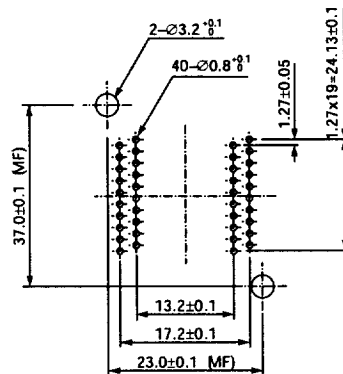

SOP IC51-0442-1315 (44 Pins)

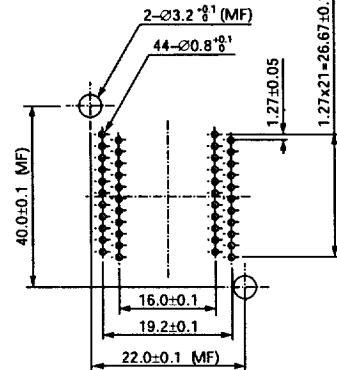

SOP, SSOP

IC51 Series

PC BOARD LAYOUTS

SOP IC51-0442-1536 (44 Pins)

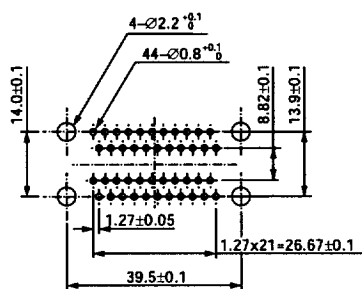

SSOP IC51-0202-779 (20 Pins)

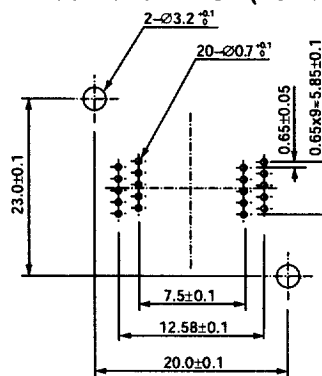

SOP IC51-0482-1009-2 (48 Pins)

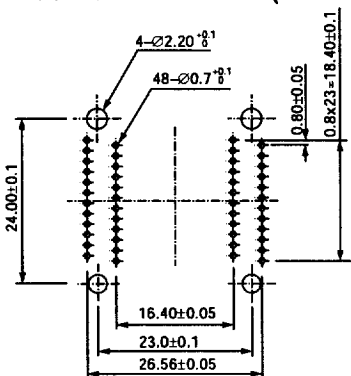

SSOP IC51-0202-912 (20 Pins)

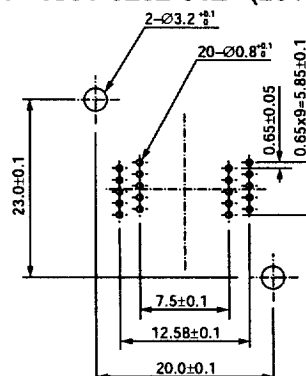

SSOP IC51-0162-911 (16 Pins)

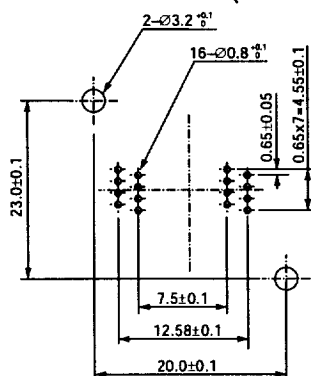

SSOP IC51-0242-913 (24 Pins)

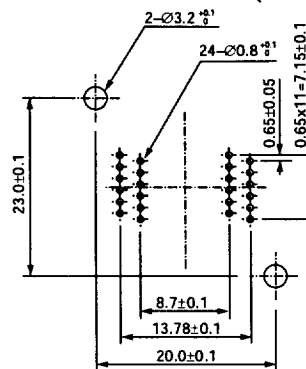

PC BOARD LAYOUTS

SSOP

IC51 Series

SSOP IC51-0242-761 (24 Pins)

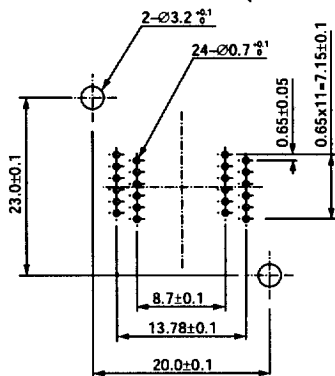

SSOP IC51-0302-914 (30 Pins)

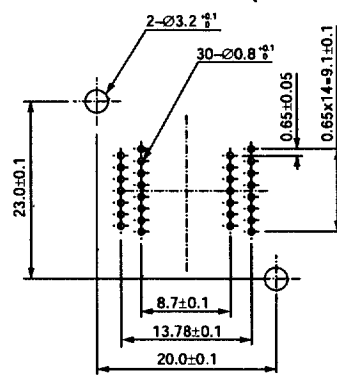

SSOP IC51-0282-673-1 (28 Pins)

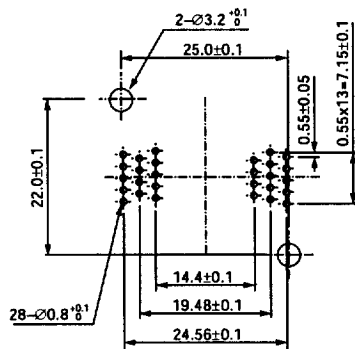

SSOP IC51-0302-755 (30 Pins)

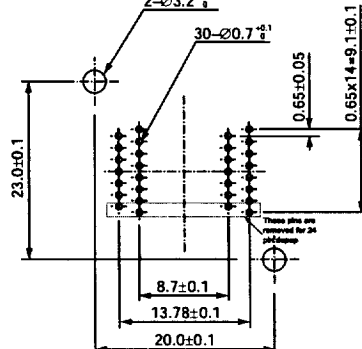

SSOP IC51-755.KS-13330 (28 Pins)

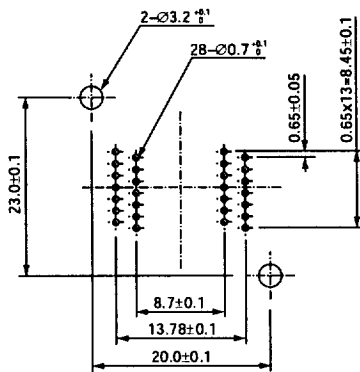

SSOP IC51-0322-910 (32 Pins)

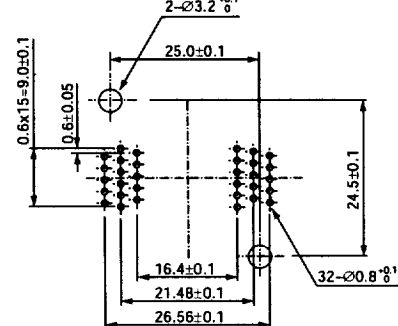

SSOP, TSOP

IC51 Series

PC BOARD LAYOUTS

SSOP IC51-1387.KS-15186 (48 Pins)*
SSOP IC51-0562-1387 (56 Pins)

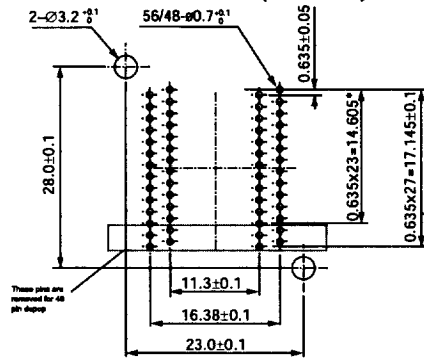

TSOP IC51-0322-1031-1 (32 Pins)

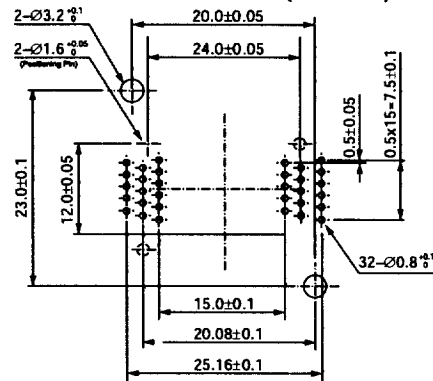

TSOP IC51-0242-1006-1 (24 Pins)

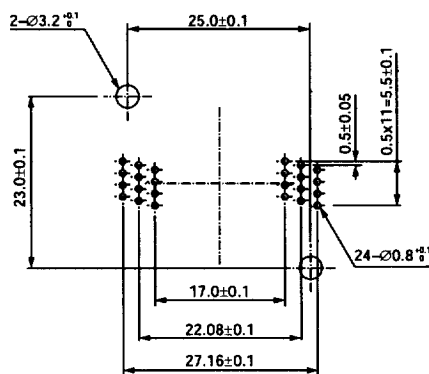

TSOP IC51-0322-883-1 (32 Pins)

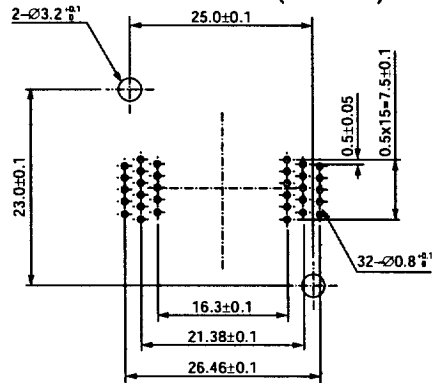

TSOP IC51-0282-1032-1 (28 Pins)

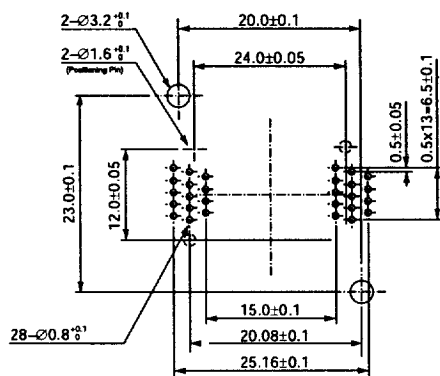

TSOP IC51-0322-1219 (32 Pins)

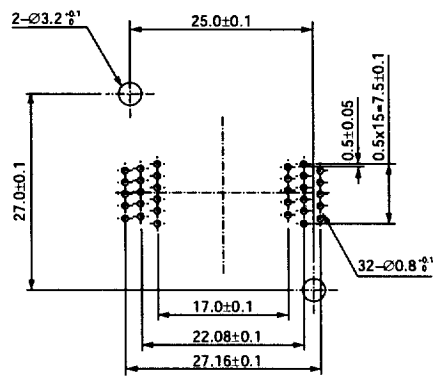

PC BOARD LAYOUTS

TSOP

IC51 Series

TSOP IC51-0322-1207-1 (32 Pins)

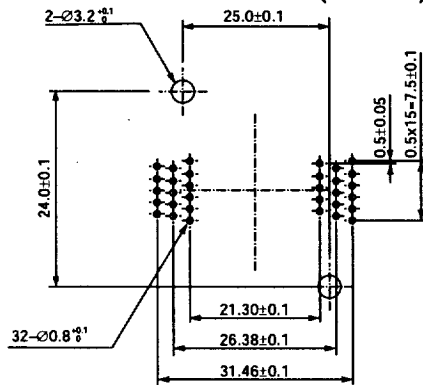

TSOP IC51-0482-1099 (48 Pins)

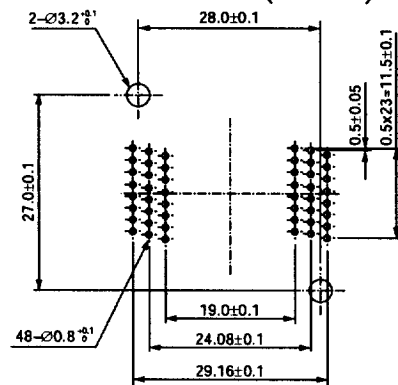

TSOP IC51-0402-1557 (40 Pins)

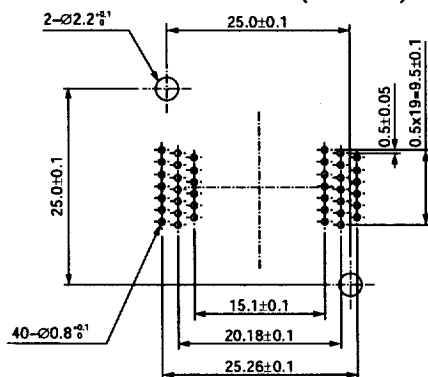

TSOP IC51-0482-2018 (48 Pins)

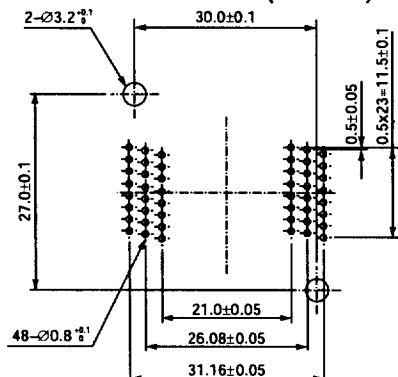

TSOP IC51-0402-1174-1 (40 Pins)

